

TABLE OF CONTENTS

USERS MANUAL P/N 29245
4075DXP-30 DTCH.

SECTION I

CRANE INSTALLATION INSTRUCTIONS

CRANE INSTALLATION INSTRUCTIONS	F1389-E.....	1-1
MOUNTING PATTERN.....	50653-A	1-4
ELECTRICAL INSTALLATION	50378-A	1-5
HYDRAULIC INSTALLATION.....	50026-A	1-6
ENGINE CONTROL RECEIVER INSTALLATION.....	F1214-D	1-7
STABILITY PROCEDURE.....	F691-G	1-8
STABILITY TEST RESULTS	F691-G	1-9

SECTION II

GENERAL OPERATION, INSPECTION, AND MAINTENANCE

CRANE SAFETY RULES.....	F1122-B.....	1-9
INTRODUCTION	F1111-D.....	1-11
OPERATING RESTRICTIONS	F1112-E	1-12
OPERATING PRACTICES	F1112-E	1-12
INSPECTION AND MAINTENANCE.....	F1113-D	1-15
MONTHLY INSPECTION REPORT	F1123-B.....	1-17
ANNUAL INSPECTION REPORT.....	F1507-0	1-18
STANDARD HAND SIGNALS FOR CRANE OPERATIONS ..	F2409-0	1-21

SECTION III

CRANE SYSTEMS AND TROUBLESHOOTING

KTG CONTROL SYSTEM.....	F1882-0	2-1
KTG ENGINE CONTROL (OPTIONAL)	F1214-C	2-3
SAFETY SYSTEM.....	F1769-0	2-4
PROPORTIONAL HYDRAULIC SYSTEM.....	F1299-A	2-6
BASIC TROUBLESHOOTING CHART	F1774-0	2-7
TROUBLESHOOTING SAFETY SYSTEM	F1254-A	2-8
TROUBLESHOOTING PROPORTIONAL SYSTEM	F1447-B	2-9
TROUBLESHOOTING FM CONTROL SYSTEM.....	F1135-B.....	2-10
DEUSTCH CONNECTORS AND PINS.....	F2435-A	2-11

SECTION IV

CRANE SPECIFICATIONS

LIFTING CAPACITIES	F2651-0	3-1
POWER FUNCTIONS AND SPEEDS.....	F2651-0	3-1
BOLT AND LUBRICATION SPECS	F2651-0	3-2
CRANE LUBRICATION POINTS.....	F2651-0	3-3



F2652-0
3/30/20

HOUSTON, TEXAS
FAX: (800) 824-5559 (USA & Canada)
FAX: (713) 688-6324
PHONE: (713) 688-5533
www.liftmoore.com

TABLE OF CONTENTS

USERS MANUAL P/N 29245
4075DXP-30 DTCH.

SECTION V PARTS

BOX PARTS LIST	F2653-0	4-1
CRANE ASSEMBLY	DWG.29244-0	4-2
FM RECEIVER XP KT GUIDER	DWG.24484-A	4-3
FM ENGINE CONTROL REPRESENTATION	DWG.24455-B	4-4
BAIL ATB	DWG.58435-E	4-5
BOOM-BODY ASSEMBLY.....	DWG.29237-0.....	4-6
ELEVATION CYLINDER ASSEMBLY	DWG.21521-E	4-7
BODY ASSEMBLY	DWG.29239-B	4-8
MANIFOLD ASSEMBLY	DWG.29241-0.....	4-9
MANIFOLD PRE-ASSEMBLY	DWG.29240-0.....	4-10
BASE-HOUSING ASSEMBLY.....	DWG.29238-B	4-11
HYDRAULIC SWIVEL	DWG.28145-0.....	4-12
BOOM ASSEMBLY – 30 FT.....	DWG.29235-0.....	4-13
BOOM OUTER ASSEMBLY – 30 FT	DWG.29233-0.....	4-14
BOOM INNER ASSEMBLY – 30 FT	DWG.27575-F.....	4-15
WINCH.....	DWG.29086-0.....	4-16
WINCH.....	DWG.29086-0.....	4-17
ROTATION SPEED REDUCER	DWG.29116-0.....	4-18
ELECTRICAL WIRING HARNESS.....	DWG.25697-B	4-19
ELECTRICAL SCHEMATIC	DWG.50823-A.....	4-20
HYDRAULIC SCHEMATIC	DWG.50913-0.....	4-21
TRAVEL BLOCK ASSY	DWG.29259-0.....	4-22
WARRANTY	F1442-A.....	



F2652-0
3/30/20

HOUSTON, TEXAS
FAX: (800) 824-5559 (USA & Canada)
FAX: (713) 688-6324
PHONE: (713) 688-5533
www.liftmoore.com

MODEL 4064/4075 INSTALLATION INSTRUCTIONS

Read and understand these instructions completely before starting the work.

Before installing make sure you have all necessary parts. Please refer to the Owner's manual Section 4-1 for the list of parts required for installation. Report any shortages to Liftmoore, Inc. immediately.

1. The mounting surface for the crane must be capable of supporting the rated moment and maximum load of the crane listed below:

4064 CRANE	40,000 Ft.-Lbs.	6,400 Lbs.
4075 CRANE	40,000 Ft.-Lbs.	7,500 Lbs.

2. Layout the mounting holes for the crane as shown in the drawing No. 50653. Cut the center hole for the crane swivel as shown on this drawing. Mount the crane with four 7/8" bolts of at least Grade 8 quality.

3. A manual disconnect switch with mounting bracket and terminals is provided with the crane. This switch will act as the main electric power disconnect for the crane. Removing power from the crane during periods of non-use will increase the life of the crane's electrical components. The switch should be mounted as near as possible to the crane and in a position which will facilitate its use. Determine the appropriate mounting position for the switch and use the supplied terminals to splice in to the crane's main power cable. Drawing No. 50378 illustrates how to install the disconnect switch and fuse.

4. Install the 30 Amp fuse, which is supplied with the crane, near the battery on the positive line. This fuse is to protect the wiring in event of an accidental grounding. Use a section of the wire and the terminals supplied to connect between the battery and the circuit breaker. See drawing No. 50378-A.

5. Run the 10 Ga. battery cable along the inside of the chassis frame to the positive battery terminal and connect it to the battery through the in-line fuse. See that the cable is protected. Avoid sharp edges and heat sources such as the muffler or catalytic converter. Use loom for protection whenever the cable passes through the body. On continuous rotation models, use the terminal supplied and connect the cable to the bolt located between the pipe nipples in the center of the swivel under the crane. On limited rotation models connect the battery wire to the 10 gage black wire under the crane.

6. Be certain that the crane and the battery are grounded to the truck chassis. A good ground must exist for the crane to work.

7. Hydraulic Component Installation: The following description applies to Liftmoore's Hydraulic Installation Drawing No. 50026.

These cranes require a pump driven by the vehicle's engine. Pumps can be either Power Take Off or Fan Belt drive. For best, smoothest operation the pump needs to supply 6 GPM at 3000 PSI with the engine at 1000 RPM. An example of this pump is Muncie's PK6. At 600 RPM it delivers 3.5 GPM and at 1000 RPM it delivers 6 GPM.

Do not use pumps that will deliver more than 6 GPM at engine speed. 10 GPM is the maximum flow acceptable to the valves in the crane. If a larger pump is installed on the vehicle for other functions, use a pressure compensated flow control valve to restrict the flow to the crane as required above.



MODEL 4064/4075 INSTALLATION INSTRUCTIONS, Cont.

A wire control or solenoid throttle advance can be used to increase the engine speed. Liftmoore can supply a solenoid throttle advance kit (Part No. 32592) that includes a control switch to be mounted near the crane. On engines with electronic throttles, the solenoid throttle advance cannot be used, check with the dealer for throttle advance information. Engine speed, start and stop control can be included in the pendant control box if ordered.

A reservoir of at least 10 gallons capacity is recommended. Reservoir capacity will need to be enlarged for increased running time. For run times of 15 minutes or less the 10 gallons capacity is adequate. For longer duty cycles the reservoir size should be increased.

The reservoir should be equipped with a suction line strainer, return line diffuser, and filler/breather cap. A sight gage for displaying fluid level is also advisable. Locate the reservoir as close to the pump as possible and as high as possible above the pump.

A relief valve should be installed at the pump's output to protect the pump from pressure surges. The crane incorporates a relief valve to protect its valves and hoses.

For up to 9.5 GPM flow the minimum suction line hose size is 1" ID. For the pressure line a 5/8" ID hose is needed. For the return line between the crane and reservoir a 3/4" ID is advised. Hose sizes can be reduced for lower flows.

A 10 Micron return line filter should be installed in a location that allows convenient access to the replaceable cartridge.

8. DO NOT RUN OIL THROUGH THE CRANE UNTIL THE OIL HAS BEEN FILTERED. An adapter union matching the crane fittings is included. Connect the supply and return lines together using this adapter, circulate the oil through the filter to insure a clean supply. After the pump has filtered 1.5 times the reservoir capacity, hook the hoses to the crane. It is now ready to run.

9. Connect the hydraulic hoses to the fittings projecting below the crane. The pressure hose must be connected to the port marked "P" (No. 8 size fitting). This is the smaller of the two fittings. The return line to the tank must be connected to the port marked "T" (No. 10 fitting). This is the larger of the two fittings. The port letters are stamped on the bottom of the swivel.

10. The Crane Assembly drawing in the owner's manual Section 4-2 illustrates how the weight should be installed on the line.

11. READ AND UNDERSTAND OPERATORS MANUAL BEFORE OPERATING CRANE. Operate the crane through all its functions. Check that each switch operates the correct function. Verify speed of the unit with the crane's operation manual.

12. A boom support is required to hold the crane and protect the crane's rotation gearing whenever the truck is moved. The boom rest will need to be modified if the boom cannot be stored in a horizontal position, either because of a tall compartment or other obstruction. Boom Rests are available from **Liftmoore, Inc.**



MODEL 4064/4075 INSTALLATION INSTRUCTIONS, Cont.

13. An outrigger must be installed to keep the crane as level as possible under all expected working conditions. Keeping the crane level reduces the loads on the rotation gear. This will also protect the truck's springs, axle and wheels when heavy loads are suspended from the crane. OSHA requirements require a stability test be performed on this installation. A suggested procedure for this test can be found at the end of this manual.
14. Extra rear spring leaves or heavy coil springs may be needed to keep the truck level when the crane is mounted on corner or off center locations.
15. Place these instructions with the Operators Manual.
16. Load Chart Decal is to be placed on the truck body for easy visibility by the user.



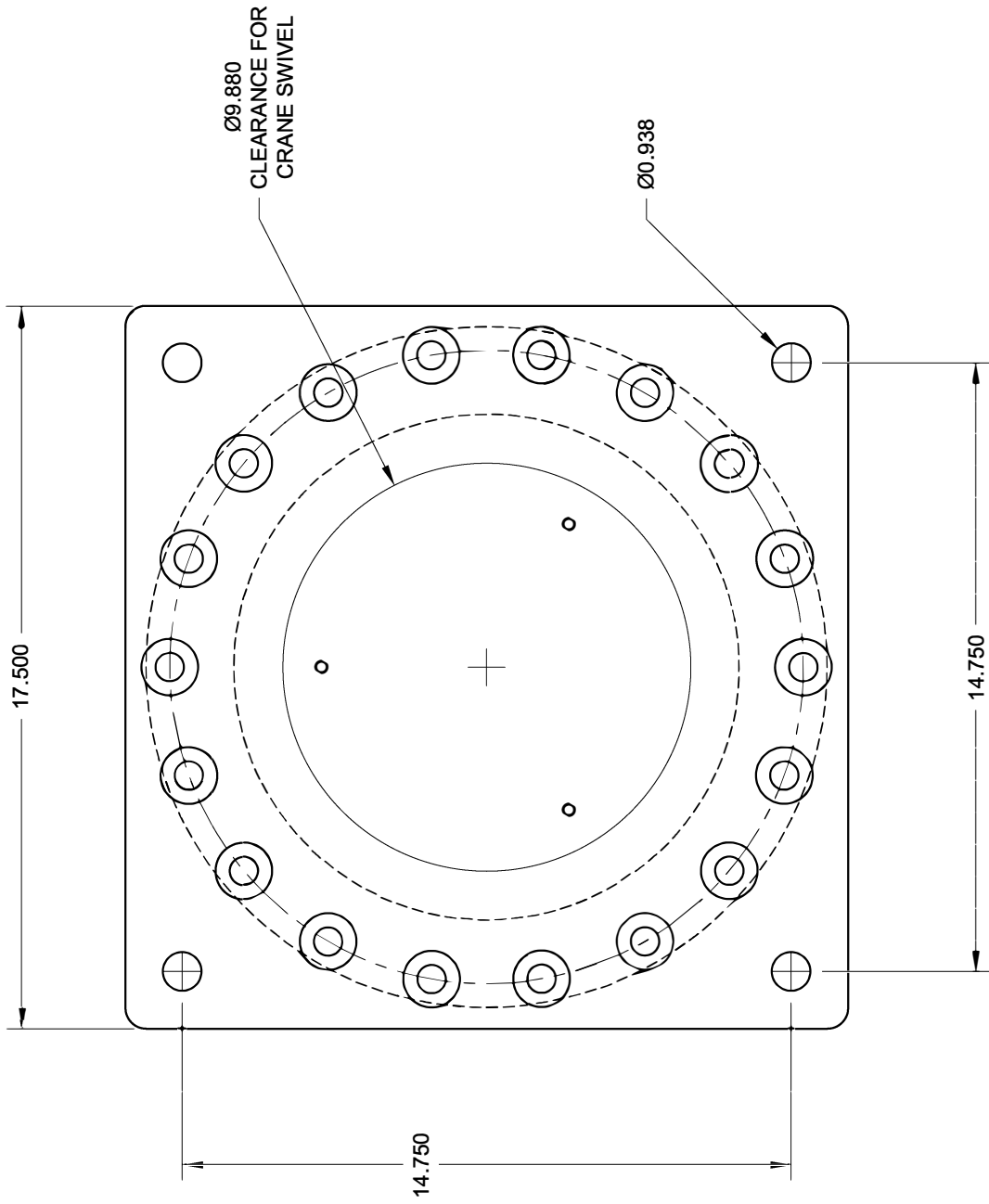

DRAWING NO.
50653-A

BASE PLATE 4064
FOR INSTALLATION MANUAL

DRWN BY: JC
DATE: 3/29/07

Houston TX
(713)-688-5533
www.liftmoore.com

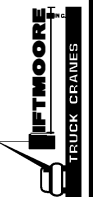

SUGGESTED WIRING SCHEMATIC FOR LIFTMOORE HYDRAULIC CRANE INSTALLATION

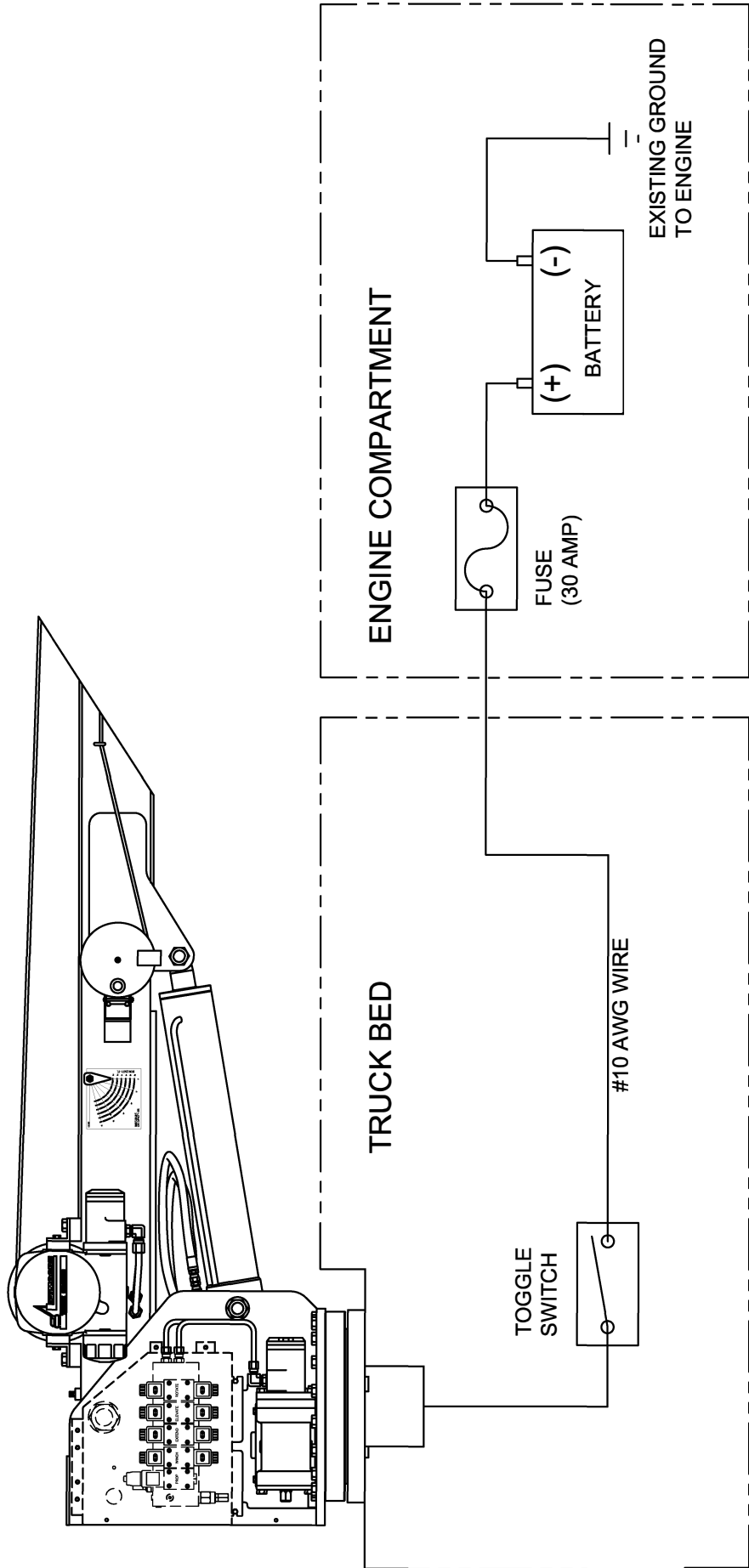

Houston TX
(713)-688-5533
www.liftmoore.com

DRWN BY: TV
DATE: 03/02/06

SCHEM, CRANE ELEC. INSTAL-HYDR

DRAWING NO.

50378-A

SUGGESTED HYDRAULIC SCHEMATIC FOR LIFTMOORE HYDRAULIC CRANE INSTALLATION

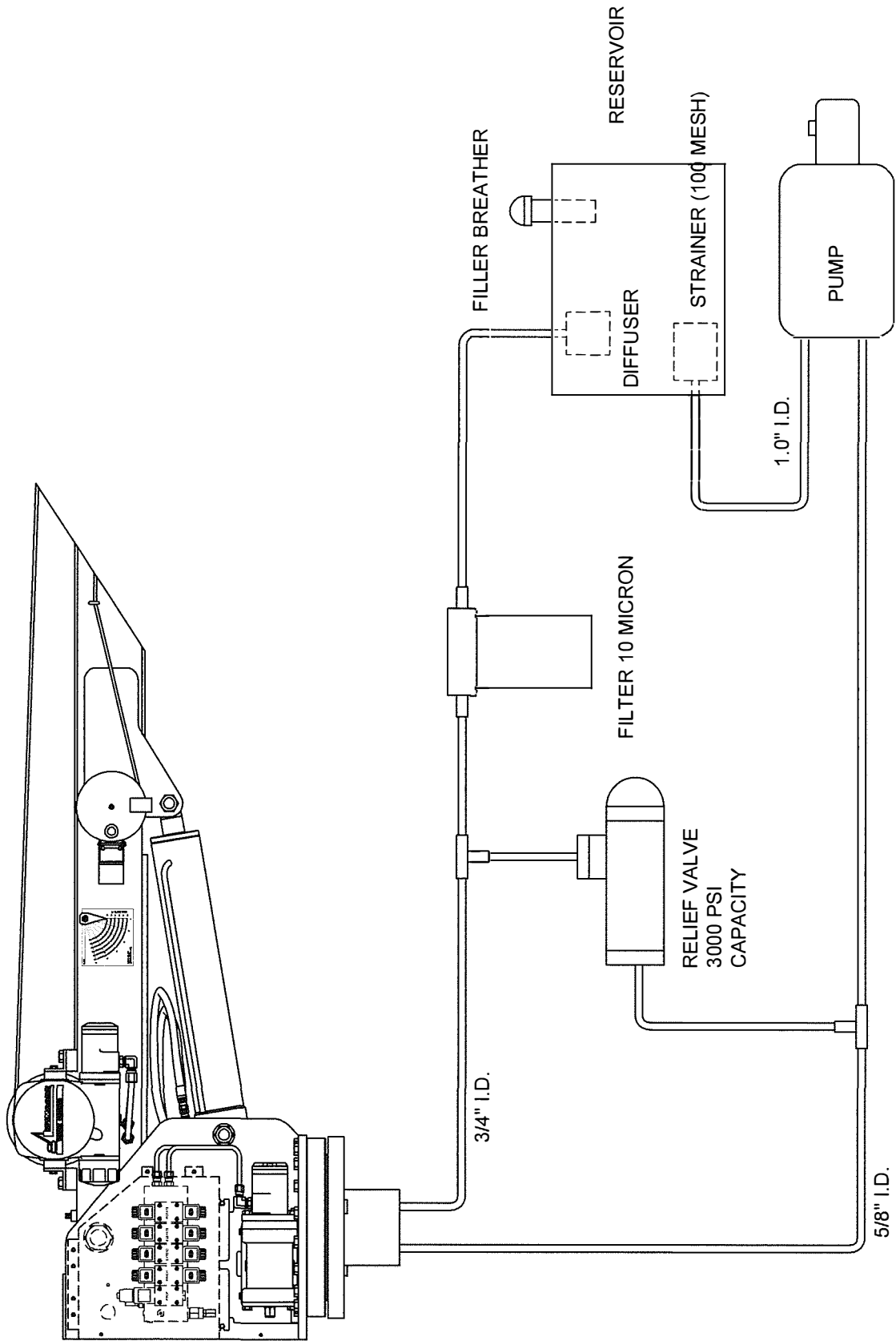

Houston TX
(713)-688-5533
www.liftmoore.com



SCHEM, CRANE HYD. INSTAL-HYD

DRWN BY: TV
DATE: 03/02/06

DRAWING NO.
50026-A

OPTIONAL ENGINE CONTROL RECEIVER INSTALLATION

The engine control functions allow the user to start and stop the engine and also advance the idle, all from the crane remote pendant control.

The following instructions provide a general guideline for installing and wiring the receiver. Since engine controls vary from manufacture to manufacturer and even from year to year, it is impossible for Liftmoore to maintain specific information on your vehicle. You will have to contact the vehicle and/or engine manufacturer (contact information is provided below). Also, many new vehicles have a provisions for remote engine control built into the ECU, but these functions must be activated and/or programmed by a dealer or authorized service center.

MOUNTING THE RECEIVER

The receiver should be mounted vertically with the antenna up. For best reception, it should be mounted in cab in line of site of operator. Since interfacing connections will generally be inside the cab, a good mounting place is the inside, back the cab with the antenna visible through the back glass. The receiver can be mounted outside of the cab, however it should NOT be mounted inside the engine compartment because of interference generated by the engine.

ENGINE START

Engine start is accomplished by splicing the brown wire on the engine receiver control harness with the ECU start circuit.

WARNING!

Engine start may bypass some manufactures safety functions such as clutch or neutral interlock. It is the installer's responsibility to ensure safe and proper installation.

ENGINE STOP

If the ECU is not equipped with a remote engine kill circuit then a normally closed relay must be installed in the ECU power or engine run circuit. The gray wire on the engine control receiver harness is then connected to the solenoid coil. Activating the circuit will open the solenoid, killing the engine.

NOTE!

It is advisable to include a small jumper wire that can be installed to bypass the solenoid should it fail, otherwise the engine would not run.

ADVANCED IDLE

Many new diesel engines have an advanced idle control circuit built into to the ECU. Some automatically advance the idle when the PTO is activated. This feature may have to be activated and/or programmed by the dealer.

NOTE!

Some engines also require activating a PTO circuit to prevent "Service Engine Soon" or other erroneous errors during PTO operation.

For gas engines or engines without this feature, an after-market throttle advance will have to be purchased separately.

CONTACT INFORMATION

Your truck or engine dealer should be able to provide you with further assistance. Also check the manufacturer's body builder manual (some provided online). Before calling, please have your vehicles make, model, year, engine and transmission size and manufacturer, and VIN if available.

Ford Body Builders Advisory Service	1.877.840.4338
GM Upfitter Integration	1.800.875.4742
Peterbilt	1.940.591.4000
Caterpillar	1.800.847.4986
Cummins	1.800.343.7357
Dodge	
Navistar	1.800.336.4500

www.fleet.ford.com/truckbbas
www.gmupfitter.com

Rammbg@chrysler.com

HOUSTON, TEXAS
 FAX: (800) 824-5559 (USA & Canada)
 FAX: (713) 688-6324
 PHONE: (713) 688-5533
www.liftmoore.com

VEHICLE STABILITY TEST

12/6/12

Liftmoore, Inc.
Form No. 691-G
Revised 1/30/2013

OSHA requires a stability test be completed by the installer. A qualified person shall perform this test. Please call Liftmoore for any assistance required in completing this test.

Test Preparations:

- Use as level of a test site as possible.
- Engage parking brake on vehicle.
- Set outriggers, jackstands, or other stability device in place.
 - Vehicle tires should remain in contact with the ground.
 - The vehicle should be level.

Fill out test form:

- Complete the vehicle and crane data at the top of Page 2 of this form.
- Use a known weight to determine the *Testing Load Radius*.

Test Procedure:

Determine Area W1 Length

1. With the crane extended to the *Testing Load Radius* over the rear of the truck, lift the load. Keep the load less than 4" off of the ground.
2. Rotate the load counterclockwise. Monitor all vehicle tires to ensure they remain in contact with the test surface.
3. When one of the vehicle's tires breaks contact with the ground, stop the rotation.
4. Use a protractor to determine this angle. Write this angle on the Stability Test Results as *Area Y*.
5. Keeping the load off of the ground, retract or elevate the boom until all tires are in contact with the test surface.
6. Continue rotating the load counterclockwise while monitoring all vehicle tires.
7. When one of the vehicle's tires breaks contact with the ground, stop the rotation.
8. Keeping the load off of the ground, retract or elevate the boom until all tires are in contact with the test surface.
9. Repeat this procedure until either the vehicle prevents further rotation or a 180 degree rotation of the load is reached.
10. Record the load radius in feet at this point on the Stability Test Results as *Area W1 Length*.

Determine Area W2 Length

11. Return the load to the rear of the vehicle and extend the load to the *Testing Load Radius*. Keep the load less than 4" off of the ground.
12. Rotate the load clockwise. Monitor all vehicle tires to ensure they remain in contact with the test surface.
13. When one of the vehicle's tires breaks contact with the ground, stop the rotation.
14. Use a protractor to determine this angle and write this angle on the Stability Test Results as *Area Z*.
15. Keeping the load off of the ground, retract or elevate the boom until all tires are in contact with the test surface.
16. Continue rotating the load clockwise while monitoring all vehicle tires.
17. When one of the vehicle's tires breaks contact with the ground, stop the rotation.
18. Keeping the load off of the ground, retract or elevate the boom until all tires are in contact with the test surface.
19. Repeat this procedure until either the vehicle prevents further rotation or a 180 degree rotation of the load is reached.
20. Record the load radius in feet at this point on the Stability Test Results as *Area W2 Length*.

Record Stability Test Results on Placard

21. Record the information from the Stability Test Results on the CRANE TRUCK STABILITY plate (P.N. 18600) and install the plate in a visible position on the vehicle, preferably near the crane.

THIS TEST IS NOW COMPLETE

STABILITY TEST FORM

Operational limits of this vehicle

VEHICLE INFORMATION	CRANE INFORMATION
Year _____	Model _____
Make _____	Serial Number _____
Model _____	Moment Rating (ft-lbs.) _____
VIN _____	_____

Determine The **Testing Load Radius** by using the following:

Moment Rating (ft-lbs.) _____
 Multiply by 1.18 x _____
 Divide by known weight ÷ _____
Testing Load Radius (ft.) = _____

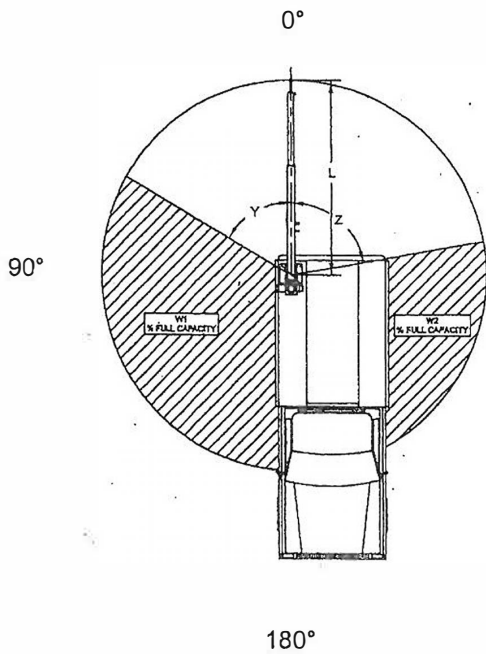

Area W1 Length _____

Testing Load Radius (ft.) ÷ _____

Multiply by 100 x _____

W1 % Rated Capacity = _____

Area W2 Length _____

Testing Load Radius (ft.) ÷ _____

Multiply by 100 x _____

W2 % Rated Capacity = _____

STABILITY TEST RESULTS

Area Y: _____ Degrees
 Area Z: _____ Degrees
 Area W1 Rated Capacity: _____ %
 Area W2 Rated Capacity: _____ %

Test performed by: _____

Date: _____

THIS PAGE INTENTIONALLY LEFT BLANK



HOUSTON, TEXAS
FAX: (800) 824-5559 (USA & Canada)
FAX: (713) 688-6324
PHONE: (713) 688-5533
www.liftmoore.com

CRANE SAFETY RULES

CAUTION!

1. READ AND UNDERSTAND OPERATOR'S MANUAL.
2. INSPECT VEHICLE AND CRANE, INCLUDING ITS OPERATION BEFORE DAILY USE.
3. USE THIS EQUIPMENT ONLY ON SOLID LEVEL GROUND WITH OUTRIGGERS OR JACKSTANDS PROPERLY SET.
4. BEFORE OPERATING THE CRANE REFER TO MAXIMUM LOAD CHART ON CRANE FOR OPERATING LOAD LIMITS.
5. BE SURE LOAD BEING LIFTED IS WITHIN SAFE WINCH CAPACITY AS WELL AS SAFE CRANE CAPACITY. MULTI-PART LINE OPERATION IS REQUIRED WHEN SINGLE LINE LOAD CAPACITY OF WINCH IS EXCEEDED.
6. DO NOT OPERATE, WALK, OR STAND UNDER THE BOOM OR ANY SUSPENDED LOAD.
7. ALWAYS PAY OUT LOAD LINE BEFORE EXTENDING BOOM. WIRE ROPE DAMAGE AND / OR BREAKAGE MAY OCCUR.
8. BOOM MUST BE IN ITS REST BEFORE MOVING VEHICLE.
9. BOOM TIP MUST BE DIRECTLY OVER THE LOAD BEFORE ANY LIFTING IS STARTED. DO NOT DRAG LOADS WITH THIS CRANE.
10. MAINTAIN THIS CRANE AS REQUIRED IN THE OWNER'S MANUAL.
11. DO NOT ALLOW PERSONNEL TO RIDE ON THE LOAD LINE, LOAD, OR BOOM OF THIS CRANE.
12. IT IS UNLAWFUL TO OPERATE THIS EQUIPMENT WITHIN TEN FEET OF HIGH VOLTAGE LINE



THIS PAGE INTENTIONALLY LEFT BLANK



F1122-B
05/12/08

HOUSTON, TEXAS
FAX: (800) 824-5559 (USA & Canada)
FAX: (713) 688-6324
PHONE: (713) 688-5533
www.liftmore.com

INTRODUCTION

This crane is a powerful machine designed to lift and move heavy loads. There are many hazards associated with these operations. Liftmoore has designed this crane to be as safe as possible but -

IT IS THE OPERATOR'S RESPONSIBILITY TO PREVENT ACCIDENTS!

This takes pre-planning, attention, and knowledge of basic principles and rules. Even if you have used similar cranes, reading this manual in its entirety will help prevent damage, injury, or even loss of life; benefits well worth the short amount of time it takes to read these pages.

REGULATORY AUTHORITY

Use of this crane is governed by OSHA 29 CFR 1910.180 and may be governed by other federal, state, or local regulations.

IT IS THE OPERATOR'S RESPONSIBILITY TO UNDERSTAND AND COMPLY WITH ALL APPLICABLE REGULATIONS GOVERNING THE OPERATION, INSPECTION, AND MAINTENANCE OF THIS CRANE.

Personnel should be trained, tested, and certified, as recommended by OSHA and ANSI standards, before operating this crane.

USING THIS MANUAL

This manual assumes that the crane is mounted on a typical service body type or similar truck, which is powered by the vehicle electrical or hydraulic system, and is controlled by either the standard pendant control or FM radio control sold by Liftmoore, Inc.

This manual is supplied to provide basic guidelines for the safe use, routine maintenance, and general inspections of this crane.

This manual is supplied to provide basic guidelines for the safe use, routine maintenance, and general inspections of this crane.

Laws, regulations, standards, or policies may be more restrictive than this manual. If a conflict exists for any limit or condition, the safest or most prohibitive shall be used. Under no circumstances shall the load, moment, or stability ratings be exceeded.

Pay particular attention to the following:

WARNING! – Draws attention to hazards, conditions, or procedures that if not observed could result in injury or death.

CAUTION! – Draws attention to hazards, conditions, or procedures that if not observed could result in damage to the crane, load, or other equipment. Equipment failure could in turn lead to injury or death.

NOTE! – Draws attention to conditions or procedures that are essential to emphasize.

For questions, interpretations, or to report errors, please contact Liftmoore, Inc, Engineering Dept.



OPERATING PRACTICES

OPERATING RESTRICTIONS

DUTY CYCLE

For Electric Cranes the duty cycle time should be limited to 10%. This is limited by heat buildup in the motors and declining charge in the batteries. (Installing extra batteries near the crane helps keep the voltage at maximum.)

PERSONNEL

LIFTING OR MOVING OF PERSONNEL IS STRICTLY PROHIBITED! This crane was neither designed nor intended to lift personnel. Under no circumstances should anyone be allowed to ride on the crane, line, or load. All non-essential personnel must be kept away when using the crane. The load must never be moved over people, nor must anyone be allowed to pass or stand under a suspended load.

ELECTRICAL LINES

Consult ANSI B30.5 for operating procedures, minimum safe distances, and prohibited zones when working around electrical lines or poles.

When operating near electrical power lines, the crane must be positioned so that the distance from the crane to the lines or poles is equal to or greater than the length of the fully extended boom plus the minimum safe distance required.

All parts of the crane, line, and load must be kept a minimum safe distance from electrical power lines and poles. This distance is 10 feet for electrical lines carrying 50kV or less.

UNDER NO CIRCUMSTANCES SHOULD A CRANE BE OPERATED UNDER ELECTRICAL POWER LINES.

SETUP

POSITION The vehicle must be positioned so that the load is kept as close to the crane base as possible to reduce the moment on the crane. Consideration must be given to starting and ending position as well as firmness and slope of the ground and any obstructions.

OUTRIGGERS The outriggers or jackstands must be firmly set and the vehicle as level as possible. This will reduce the stresses on the rotation drive and keep the load off the vehicle's suspension. Keep in mind that the weight on the vehicle will shift as the crane and load is rotated.

MANUAL BOOM EXTENSION If the manual extension part of the boom is needed, it must be extended and the boom pin placed in the required position. Insert the pin and replace the pin's hairpin keeper before attempting to lift any load.

LOAD LIMIT The operator must understand the crane load chart. The operator must ensure that the load is within the load limits over the entire range which it will be moved. Be sure to include the weight of any lifting devices including the travel block.

The load limit chart is attached to the side of the crane to aid the operator.

The boom angle indicator and chart aids the operator in determining the load capacity at various boom angles and extensions. It also gives the load limit at that configuration.

STABILITY A stability chart must be posted near the crane. The operator must understand the stability chart. The crane may be de-rated over some areas of its operating radius.



TRAVEL BLOCK The operator must determine if the load is within the single line compatibility of the winch or if a multi-part line configuration is needed.

REEVING Ensure the proper routing of the rope through the sheaves and travel block. The rope must lie in the sheave groove and must not rub against any metal objects.

Ensure the rope is correctly wound on the winch drum. The crane assembly drawing will indicate if the rope must be wound over the top or bottom of the drum. The rope must never contact any part of the winch mounting.

WARNING!

If the winch winding direction is reversed the brake will not work and the load will fall.

ATTACHING THE LOAD

POSITION The boom tip must be moved over the load before lifting so that it will be lifted straight up.

CAUTION!

Never drag a load with the crane. Dragging a load puts very high stresses on the crane for which it was not designed.

ROPE Check the rope condition to ensure it is not frayed or damaged. Ensure that the rope is not kinked and that it does not contact any sharp edges or make any sharp bends.

If using double line configuration, ensure that the lines are not twisted.

CAUTION!

Never wrap the hoist rope around the load! Serious damage to the rope WILL occur.

HOOK Always make sure the load is applied to the throat of the hook. Never use a bent hook.

CAUTION!

Always lift with the throat of the hook. Never lift with the load applied to the tip of the hook. Doing so will bend the hook.

SLINGS If the load does not have a lifting eye, use a nylon, chain, or other type of sling designed for lifting and rated for loads greater than that being lifted.

BALANCE Ensure the load will be secure and balanced when lifted. Ensure that the load cannot shift in the sling and that the sling cannot slide across the hook should the load become unbalanced.

LIFTING THE LOAD

Before lifting, ensure that the load is free from all mountings and is no way attached or stuck to anything.

Ensure that at least five full wraps remain on the winch drum at all times.

Test the winch brake by lifting the load a few inches and ensuring that it does not slip.



HOLDING THE LOAD

The operator must keep the load in sight at all times once it is lifted.

The operator must never leave the controls once the load is lifted.

The operator must ensure that no one is allowed to pass or stand under a suspended load.

TRANSIT

While in transit, the crane must be stowed, preferably in a boom rest. The crane must be prevented from rotating and the hook prevented from swinging.

CAUTION!

Never move the vehicle with a suspended load. Doing so will put dynamic loads on the crane for which it was not designed.

MOVING THE LOAD

Before moving the load, make sure the path is free of any obstructions or people.

Avoid sudden accelerations or stops. Speeds must be kept to a minimum, especially rotation, to keep the load from swinging.

Avoid sudden reversing of direction. Do not reverse direction while the load is still moving.

Make sure that no part of the crane, boom, or load makes contact with any obstruction or comes within a minimum of ten feet from any electrical line.



INSPECTION AND MAINTENANCE

OSHA and ANSI require frequent and periodic inspections. Records of these inspections must be kept readily available. Liftmoore requires periodic maintenance to ensure proper operation and prolonged life of the crane.

INSPECTION

DAILY INSPECTION

OSHA 29CFR 1910.180 (d)(2)(i) requires the following be checked daily prior to use:

- All control mechanisms for maladjustment interfering with proper operation as well as for excessive wear of components and contamination by lubricants or other foreign matter.
- All safety devices for malfunction. This should include the anti-two block and pressure switch.
- Deterioration or leakage in air or hydraulic systems.
- Crane hooks with deformations or cracks. For hooks with cracks or having more than 15 percent in excess of normal throat opening or more than 10 deg. twist from the plane of the unbent hook.
- Electrical apparatus for malfunctioning, signs of excessive deterioration, dirt, and moisture accumulation. This should include the battery terminals, master disconnect switch, electrical swivel
- The wire rope shall be replaced if any of the following conditions are noted:
 - Kinking, crushing, bird-caging, or other damage
 - Reductions from nominal diameter of more than one-sixty-fourth inch for diameters up to and including five-sixteenths inch, one-thirty-second inch for diameters three-eighths inch to and including one-half inch.
 - Thimble is not in place or is damaged
 - Any evidence of heat damage
 - Six or more randomly distributed broken wires in 1 lay
 - Three or more broken wires in 1 strand in 1 lay

MONTHLY INSPECTION

A thorough inspection of all ropes in use shall be made at least once a month and a certification record which includes the date of inspection, the signature of the person who performed the inspection and an identifier for the ropes shall be prepared and kept on file where readily available. All inspections shall be performed by an appointed or authorized person. Any deterioration, resulting in appreciable loss of original strength shall be carefully observed and determination made as to whether further use of the rope would constitute a safety hazard. Some of the conditions that could result in an appreciable loss of strength are the following:

- Reduction of rope diameter below nominal diameter due to loss of core support, internal or external corrosion, or wear of outside wires.
- A number of broken outside wires and the degree of distribution of concentration of such broken wires.



- Worn outside wires.
- Corroded or broken wires at end connections.
- Corroded, cracked, bent, worn, or improperly applied end connections.
- Severe kinking, crushing, cutting, or unstranding.

PERIODIC INSPECTION

An Annual Inspection Form is included in this manual. OSHA 29CFR 1910.180 (d)(2)ii) requires periodic inspections of this crane. Liftmoore recommends an annual inspection using the included form.

MAINTENANCE PRECAUTIONS

The crane should be maintained monthly for safety reasons and to reduce stress on the crane.

WARNING!

Never perform any maintenance while the crane has any type of load on it. Use the manual operation procedure to lower the load if necessary.

WARNING!

Hydraulic cylinders may have high pressure stored in them even after hydraulic power is removed.

The counterbalance and pilot operated check valve in the cylinder will always hold some pressure in the cylinder. Slightly extending the cylinder then retracting a small amount will relieve most of the pressure in the cylinder. **DO NOT DEADHEAD THE CYLINDER!** This will store the maximum amount of pressure in the cylinder. Care should be taken when either valve is removed from the cylinder as some pressure will still remain.

After any maintenance has been performed the crane shall not be operated until all guards have been reinstalled, all safety

devices reactivated, and maintenance equipment removed.

LUBRICATION Refer to the crane specification section for the periodic maintenance schedule and type of lubrication required.

BOLTS Bolts may loosen over time due to vibration; therefore they should be checked periodically. If bolts need to be replaced, make sure they are replaced with bolts of equal or greater strength. Check the periodic maintenance schedule (Crane Specification Section) for bolt specification and torque.

NOTE!

Sheave and boom and cylinder pivot bolts are not standard bolts. The shank and thread length of these bolts have been modified so that they do not pivot on the threads. Consult the parts section of this manual for part numbers of these bolts.

OTHER MAINTENANCE

Refer to parts drawings for any specific maintenance or adjustment procedures such as hydraulic winch brake, rotation drive gear set adjustment, Ect.



MONTHLY INSPECTION REPORT

Crane Model No. _____ **Serial Number** _____

Are Boom Hitch Pins and Keepers in place?	Yes _____	No _____
Wire Line Hook with Safety Latch Working?	Yes _____	No _____
Is Hook OK, (Not bent)?	Yes _____	No _____
Is Thimble on Wire Rope OK?	Yes _____	No _____
Is Traveling Block in use?	Yes _____	No _____
Is Wire Rope OK, not kinked or frayed?	Yes _____	No _____
Are all Boom Sections straight?	Yes _____	No _____
Are Sheave Bolts in place and tight?	Yes _____	No _____
Do all Sheaves rotate easily?	Yes _____	No _____
Are Mounting Bolts tight?	Yes _____	No _____
Is Anti Two-Block functioning properly?	Yes _____	No _____
Is Boom Angle Indicator in place and functioning and is Chart legible?	Yes _____	No _____
Are Cylinder Mounting Bolts secure?	Yes _____	No _____
Are Winch Mounting Bolts tight?	Yes _____	No _____
When stopped does winch drift less than 1.0 Inches?	Yes _____	No _____
Is Load Chart in place and easily read?	Yes _____	No _____
Are functions on Pendant operating correctly?	Yes _____	No _____
Is Hydraulic Reservoir full?	Yes _____	No _____
Is Outrigger straight and functioning?	Yes _____	No _____

Any items checked 'No' must be repaired before using this crane.



ANNUAL CRANE CERTIFICATION (29CFR1910.180)

OWNER _____

MODEL NUMBER _____ SERIAL NUMBER _____

DATE _____

Check the following:

___ Crane Mounting Bolts (Torque)

___ Winch mounting Bolts (Torque)

___ Boom mounting bolts

___ Cylinder mounting bolts

___ Cracks on boom (Check when extended)

___ Extension Pads not worn excessively

___ Cracks on housing

___ Weld cracks on boom

___ Weld cracks on housing

___ Boom swing approximately one inch or less at boom tip when retracted

___ Hydraulic leaks

___ Hoses not chafed or cracked

Sheaves not cracked

___ Boom Tip

___ Traveling Block

___ Sheaves not worn excessively

___ Boom Tip

___ Traveling Block

___ Sheaves rotate freely

___ Boom Tip

___ Traveling Block

- ___ *Load Chart in place and legible*
- ___ *Boom angle chart in place and legible*
- ___ *Labels in place (See manufacturer's chart)*
- ___ *Crane Hook Throat Opening within 15% of standard*
- ___ *Crane Hook not bent more than 10 degrees from plane*
- ___ *Hook safety latch operating properly*
- ___ *Booms pin(s) and Keeper(s) in place (Manual Extension Section)*
- ___ *Wire Rope removed if the following occurs:*

Six randomly distributed broken wires in one lay or three broken wires in one strand in one lay.

Wear of one-third the original diameter of outside individual wires.

Kinking, crushing, bird-caging or any other damage.

Evidence of heat damage.

Reduction from nominal diameter of more than one sixty-fourth inch for diameters to five-sixteenths diameter and one-thirty-second inch for diameters three-eighths to one-half inch.

- ___ *Wire Line installed as manufacturer requires.*
- ___ *Protective covers in place*
- ___ *Grease crane as required*

Check fluid level

- ___ *Winch*
- ___ *Gearbox*
- ___ *Reservoir*

Control system for proper operation

___ *Winch Up and Down*

___ *Boom Up and Down*

___ *Boom In and Out*

___ *Rotation CW and CCW*

Anti Two-Block (Required on Power Extendible Cranes) interrupts:

___ *Boom Down*

___ *Boom Out*

___ *Winch Up*

___ *Boom Up stopped by Up Limit Switch*

___ *Outrigger or jackstand operable*

___ *Outrigger crushing decal in place*

___ *Outrigger and Jackstand operates properly*

___ *Boom rest in place and used*

___ *Load Sensor trips when overloaded*

___ *Winch Down does not overrun when stopped*

___ *Crane stability chart in place and visible.*

I certify that I have performed the above tests and that any deficiencies were corrected and now comply as above.

Signed _____



Print Name _____

Company _____

Address _____

City _____ *State* _____

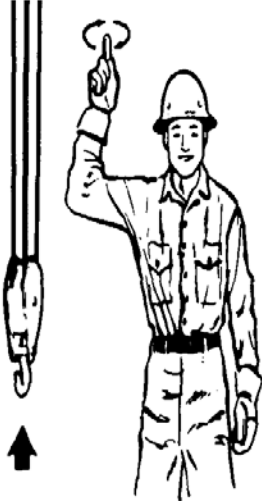
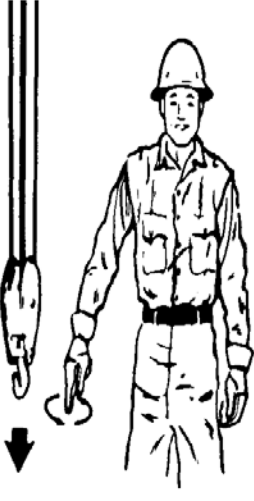
STANDARD HAND SIGNALS FOR CONTROLLING CRANE OPERATIONS

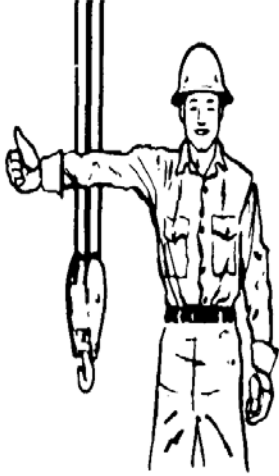
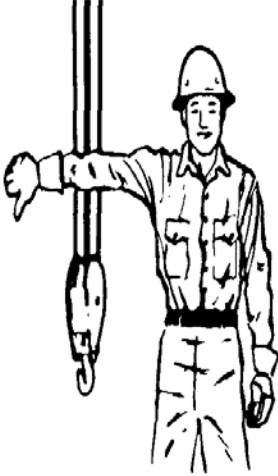
 <p>HOIST. With forearm vertical, forefinger pointing up, move hand in small horizontal circle.</p>	 <p>LOWER. With arm extended downward, forefinger pointing down, move hand in small horizontal circle.</p>	 <p>USE MAIN HOIST. Tap fist on head; then use regular signals.</p>
 <p>USE WHIPLINE (Auxiliary Hoist). Tap elbow with one hand; then use regular signals.</p>	 <p>RAISE BOOM. Arm extended, fingers closed, thumb pointing upward.</p>	 <p>LOWER BOOM. Arm extended, fingers closed, thumb pointing downward.</p>

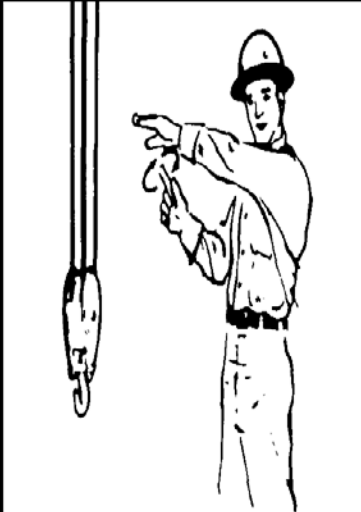
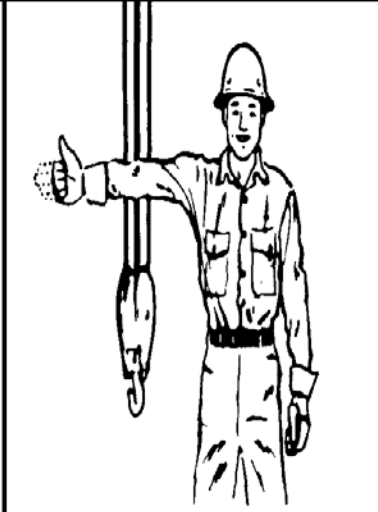
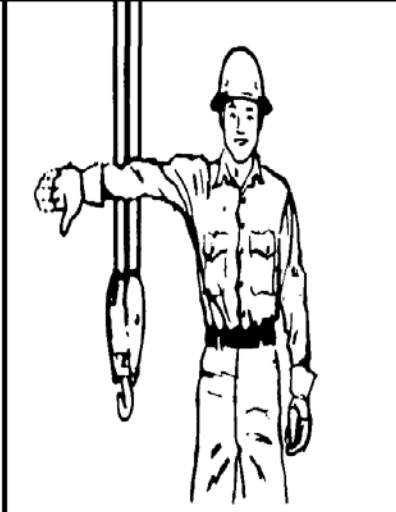
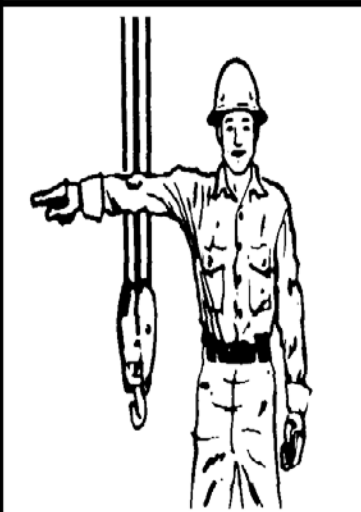
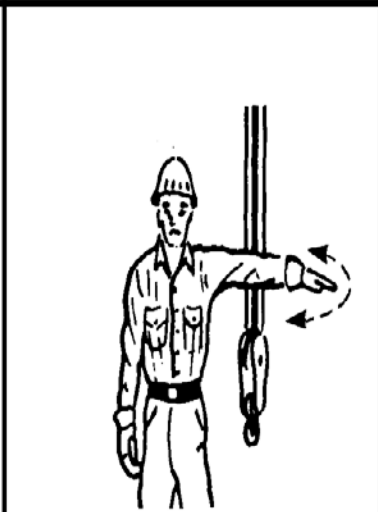
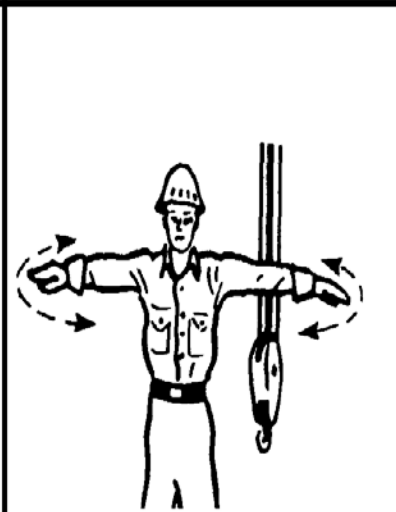
 <p data-bbox="245 745 604 968">MOVE SLOWLY. Use one hand to give any motion signal and place other hand motionless in front of hand giving the motion signal. (Hoist slowly shown as example.)</p>	 <p data-bbox="604 745 979 968">RAISE THE BOOM AND LOWER THE LOAD. With arm extended, thumb pointing up, flex fingers in and out as long as load movement is desired.</p>	 <p data-bbox="979 745 1372 968">LOWER THE BOOM AND RAISE THE LOAD. With arm extended, thumb pointing down, flex fingers in and out as long as load movement is desired.</p>
 <p data-bbox="245 1476 604 1650">SWING. Arm extended, point with finger in direction of swing of boom.</p>	 <p data-bbox="604 1476 979 1650">STOP. Arm extended, palm down, move arm back and forth horizontally.</p>	 <p data-bbox="979 1476 1372 1650">EMERGENCY STOP. Both arms extended, palms down, move arms back and forth horizontally.</p>

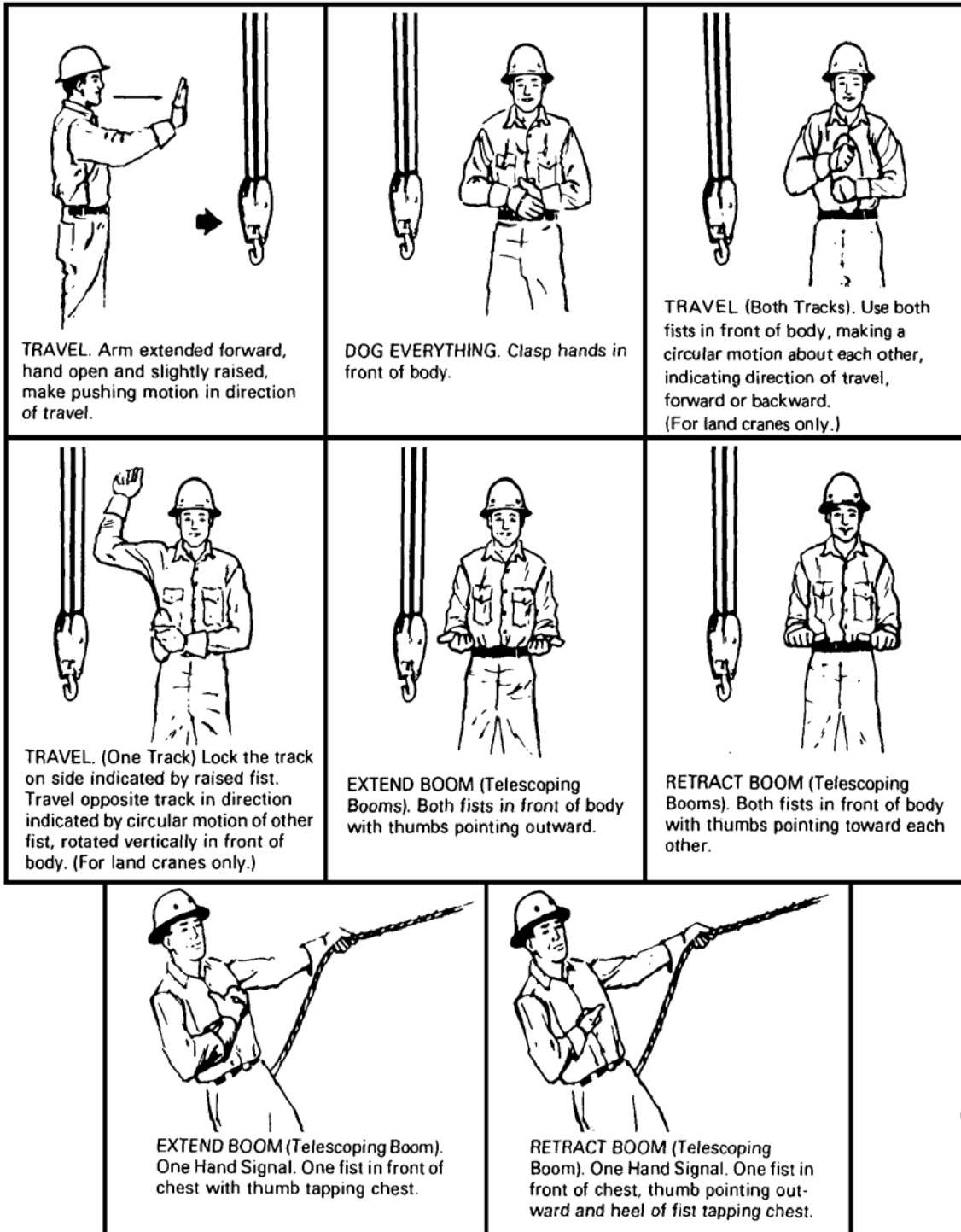

THIS PAGE INTENTIONALLY LEFT BLANK



FM CONTROL SYSTEM

KTG – 4TH Generation KTFM (Hall Effect Trigger)

The Liftmoore FM control system Model KTG is a microprocessor-based radio/CAN remote control system. It allows the operator to control the crane using FM radio signals or the digital Control Area Network (CAN) protocol.

The standard system consists of a transmitter, crane receiver/control system, CAN cable, and a battery charger. For systems with engine control an additional engine control receiver is included.

RECEIVER

The crane receiver is a self-contained control system. It contains the FM receiver, limiting system, and proportional valve driver (for proportional control cranes only). It receives power and safety circuit inputs (ATB and load sensor) from the crane. User inputs are received from the transmitter by FM radio signals or through the CAN cable. A green signal reception LED (light) and a red error code LED are provided for user diagnostics.

Error codes are indicated by counting the flashes of the red error code LED. The number of flashes represents the error code listed on the front of the receiver.

NOTE!

Error Code 1, which appears as continual, steady blinking, will remain active until a signal is received.

TRANSMITTER

The transmitter is a hand held unit which sends user input to the receiver by FM radio signals or by the CAN cable. Its features consist of an on/off push button switch, double acting momentary contact switches for each function, a 4 pin connector for attaching the CAN/charging cable, low battery light, and a transmit light.

For proportional control cranes a trigger is provided for speed control.

A Start/Stop toggle switch and an Engine High/Auxiliary toggle switch are provided for engine control. They work with the **optional** engine control receiver. If the crane was not ordered with this feature, it may be added. Contact your distributor or Liftmoore for more information.

TRANSMITTER FLASHING LIGHTS CODES (lights located next to E-Stop button)

The green transmit light will flash any time a user input is being transmitted.

Red & green flashing Simultaneously: Load sensor tripped.

Red & green Flashing Alternately: Anti-Two Block (pickle weight) tripped.

BATTERY AND CHARGING

The transmitter is powered by a NiMH battery or from the crane power source when attached to the CAN cable. Connecting the transmitter to the CAN cable also charges the battery. To conserve battery power the transmitter will turn itself off if idle for 1 hour.

When battery voltage drops below 9V the battery light will blink once every 30 seconds. As the battery voltage continues to drop the light will blink faster.

The Universal Guider (KTG) is designed with NiMH batteries, much more power, last longer and has a sensor. The Universal Guider is designed with smart charger which can charge a dead battery in couple hours and when the battery is charged it will shut off the charging and turn the battery light (on the bottom of pendant Green. This way it can be left on all the time. It also works on 12 and 24 volt systems.

Light at the Bottom of pendant (lights up when charger is connected)

Red light means **charging**
Green light means **charged**.

COMPONENT

REPLACEMENT

Each transmitter is encoded with a digital ID that is programmed to its specific receiver.



The receiver then only accepts signals from that transmitter so multiple cranes may be operated in the same vicinity without interference. If either component needs to be replaced, the receiver must be programmed to accept the new transmitter ID. This is easily done with a temporary wiring harness. Contact Liftmoore for more information.

Normal OPERATION

Turn on power to the crane and ensure the receiver is also receiving power.

Turn on the transmitter by holding the power button for at least a half of a second or until the power and transmit lights stop flashing. Note that when the flashing stops the green light will be on and remain on until the button is released.

Select a function and press the toggle switch in the desired direction as indicated on the label.

If the crane is a proportional control type, then SLOWLY squeeze the trigger after the function switch is activated.

NOTE!

If the trigger is pulled before a function switch is activated Error Code 7 will be active and the crane will not function. The trigger finger should remain off of the trigger until after a function is selected.

SPECIAL OPERATION

CHANNEL LOCKING

If excessive interference is experienced, the transmitter can be set to use only one frequency.

To lock a channel, turn off the transmitter power then hold HOIST DOWN and ROTATION CCW while turning the power on.

The Low Battery LED will blink several times. The number of flashes will indicate the channel number that it is locked on.

Channel Lock will remain active until the transmitter is turned off.

POWER ADJUSTMENT

The transmitter can be set at one of 4 power levels. Increasing the power will increase the range and reliability, but will decrease battery life.

To change the power setting activate and hold ENGINE SPEED and BOOM UP for 3 seconds. The red (Low Battery) LED will flash from 1 to 4 times to indicate the power level.

The power level will remain set until changed by the user, even if the transmitter is turned off.

ENGINE CONTROL (OPTIONAL)

If the FM system was ordered with the engine control option an engine control receiver will be included, if not it may be ordered separately. Contact your distributor or Liftmoore for more information.

TRANSMITTER

Both engine control switches are double acting momentary toggle switches. One controls start and stop and the other controls high idle and an auxiliary function.

RECEIVER

Both the start and stop output signals are momentary, i.e. the output signal is on only when the switch is held.

The auxiliary output is maintained. When the switch is pressed the signal toggles, i.e. the first time the switch is activated the signal turns on, the second time it is activated the signal turns off.

The high idle signal can be set up as either maintained or momentary as needed. If a positive voltage is supplied to pin 5 then the output is momentary, otherwise the output is maintained.



OPTIONAL ENGINE CONTROL RECEIVER INSTALLATION

The engine control functions allow the user to start and stop the engine and also advance the idle, all from the crane remote pendant control.

The following instructions provide a general guideline for installing and wiring the receiver. Since engine controls vary from manufacture to manufacturer and even from year to year, it is impossible for Liftmoore to maintain specific information on your vehicle. You will have to contact the vehicle and/or engine manufacturer (contact information is provided below). Also, many new vehicles have a provisions for remote engine control built into the ECU, but these functions must be activated and/or programmed by a dealer or authorized service center.

MOUNTING THE RECEIVER

The receiver should be mounted vertically with the antenna up. For best reception, it should be mounted in cab in line of site of operator. Since interfacing connections will generally be inside the cab, a good mounting place is the inside, back the cab with the antenna visible through the back glass. The receiver can be mounted outside of the cab, however it should NOT be mounted inside the engine compartment because of interference generated by the engine.

ENGINE START

Engine start is accomplished by splicing the brown wire on the engine receiver control harness with the ECU start circuit.

WARNING!

Engine start may bypass some manufactures safety functions such as clutch or neutral interlock. It is the installer's responsibility to ensure safe and proper installation.

ENGINE STOP

If the ECU is not equipped with a remote engine kill circuit then a normally closed relay must be installed in the ECU power or engine run circuit. The gray wire on the engine control receiver harness is then connected to the solenoid coil. Activating the circuit will open the solenoid, killing the engine.

NOTE!

It is advisable to include a small jumper wire that can be installed to bypass the solenoid should it fail, otherwise the engine would not run.

ADVANCED IDLE

Many new diesel engines have an advanced idle control circuit built into to the ECU. Some automatically advance the idle when the PTO is activated. This feature may have to be activated and/or programmed by the dealer.

NOTE!

Some engines also require activating a PTO circuit to prevent "Service Engine Soon" or other erroneous errors during PTO operation.

For gas engines or engines without this feature, an after-market throttle advance will have to be purchased separately.

CONTACT INFORMATION

Your truck or engine dealer should be able to provide you with further assistance. Also check the manufacturer's body builder manual (some provided online). Before calling, please have your vehicles make, model, year, engine and transmission size and manufacturer, and VIN if available.

Ford Body Builders Advisory Service	1.877.840.4338
GM Upfitter Integration	1.800.875.4742
Peterbilt	1.940.591.4000
Caterpillar	1.800.847.4986
Cummins	1.800.343.7357
Dodge	
Navistar	1.800.336.4500

www.fleet.ford.com/truckbbas
www.gmupfitter.com

Rammbg@chrysler.com

HOUSTON, TEXAS
FAX: (800) 824-5559 (USA & Canada)
FAX: (713) 688-6324
PHONE: (713) 688-5533
www.liftmoore.com

SAFETY SYSTEM

The safety system is designed to help prevent damage to the crane that would be caused by overload or two-blocking. The system consists of a load sensor, anti-two block device (optional on smaller, electric cranes), and limiting system control board.

When the applicable switch detects an overloading or two-block condition, the limiting system will prevent activation of winch up, and extend out since these directions would cause damage. Winch down, boom down, boom up, extend in, and power rotation will still function so that the crane can be moved to a safe configuration.

CAUTION!

Never de-activate or override safety functions. Doing so can result in serious damage to the crane and possibly injury or death.

LOAD SENSOR

A pressure activated switch in the elevation cylinder acts as a load sensor. This switch is normally closed and opens at the preset pressure corresponding to the load rating of the crane.

CAUTION!

The load sensor will not function when the elevation cylinder is fully retracted and is inaccurate when the boom is below horizontal.

CAUTION!

The operator must never rely strictly on the load sensor to determine overload conditions. The load and load limits must always be known and adhered to.

ANTI-TWO BLOCK

The anti-two block device (optional on smaller electric cranes), mounted on the boom crown plate, consists of a normally open switch actuated by a lever. A weight is attached to the lever and holds the switch

closed. If the weight is lifted by the hook or travel block the switch opens.

The power and signal wires are wired through the cord reel, which is in turn wired to the ATB switch.

LIMITING SYSTEM CONTROL

Two systems are included to limit crane overloads and wire rope breakage. When a crane overload occurs, the load sensor will stop winch up, extension out and boom down. To prevent breaking the wire rope, the Anti Two-Block device stops winch up and extension out when either is engaged.

The capacity of boom up is limited by the pressure setting of the relief valve in the manifold.

There is a one second delay before the deactivation of boom down when the load sensor is tripped to prevent false readings caused by pressure spikes.

MISCELLANEOUS

UP LIMIT SWITCH

The up limit switch prevents the elevation cylinder from reaching full extension. If the elevation cylinder were to "dead-head", the resulting pressure would activate the load sensor, preventing boom down. The boom would then have to be lowered using the manual operation buttons on the solenoid valves.

CIRCUIT BREAKER, FUSE

For electric cranes a 150 Amp circuit breaker is supplied with the crane. It should be installed as close to the battery as possible. For hydraulic cranes a 10 Amp blade type fuse is supplied.

DISCONNECT SWITCH

A power disconnect switch is supplied with the crane. Power to the crane should be turned off whenever not in use. This is to prevent inadvertent or unauthorized use and will help prevent corrosion at electrical connections.



HYDRAULIC SYSTEM

Sterling HYD Proportional

The hydraulic system consists of the hydraulic swivel, manifold with solenoid valves, and actuators (cylinders, motors) Hydraulic power is received from an external hydraulic source, typically a PTO driven pump attached to the vehicle transmission. The hydraulic manifold is plumbed in series and uses open center valves so that more than one function can be operated simultaneously.

SWIVEL

The hydraulic swivel is a two-port swivel that allows continuous, unlimited rotation. Refer to drawing for more information.

MANIFOLD

The hydraulic manifold contains the system relief valve, proportional flow control valve, and a directional control valve for each function.

The system relief valve prevents damage that would be caused by over pressurizing the system. It is a cartridge type valve located at the pump port of the manifold. Factory setting is 3000PSI.

The proportional valve is an electrically operated flow control valve. Regulated flow is directed to the manifold while excess flow is returned to tank. Before activation, all flow is returned directly to tank, minimizing heat build up. During operation the flow is regulated proportionally to the input voltage⁽¹⁾ allowing the operator to control the speed of the crane. The valve cracks at approximately 2V and allows approximately

MANUAL VALVE OPERATION

If electrical problems occur the proportional valve and function valves may be operated

7GPM at 6V. A screw on top of the valve is used to manually operate the valve.

(1) Technically, flow is directly proportional to amperage. Since the resistance is essentially constant, voltage is proportional to amperage. Within the accuracy required for this application, it can be said that the flow is directly proportional to the voltage

Each hydraulically operated function is controlled by a 4 way, 3 position open center solenoid valve. It is electrically operated and spring biased to center. A manual operation feature is also incorporated.

CYLINDERS

Hydraulic cylinders are double acting cylinders with integrally mounted counterbalance valves. This valve performs 3 functions:

- Controls the rate of decent when lowering the load
- Keeps load from falling in the event of sudden loss of system pressure, such as when a hose bursts.
- Acts as a relief valve to prevent damage from induced load or thermal expansion.

It allows free flow to extend, then blocks flow until opened by pilot pressure to the retract port or when the relief pressure is reached.

Some cylinders utilize a pilot operated check valve on the retract port to prevent the cylinder from creeping out under no load conditions. This valve allows flow into, but prevents flow from the retract port, thus hydraulically locking the cylinder until opened by pilot pressure to the extend port.

manually. Refer to the manifold drawing for valve location and directions.

To operate the crane, both the function valve and the proportional valve must be opened. If only the proportional system is not

functioning, it will be easiest to manually set the proportional valve and operate the function with the pendant control. If the functions are not operating, it will be easiest to operate both the function valves and proportional valve manually.

To operate the function valves, pull the locking collar back to unlock it. The manual operation button may then be pushed or pulled depending on desired direction. The valve is spring bias to center so the function will stop when the manual operation button is released.

The proportional valve must also be opened for the crane to operate. It uses a screw type manual override that allows precise control of the speed. To set, operate a function valve, then turn knurled knob on the proportional valve counter-clockwise until the crane begins moving. Adjust until the desired speed is reached. When finished be sure to reset the valve by screwing the knob all the way in (clockwise).

CAUTION!

If the proportional valve is not reset the crane will operate without trigger input. This may result in unexpected motion of the crane, resulting in equipment damage or personal injury.

If hydraulic power is lost while a load is suspended, the load may be lowered by decreasing the setting on the counterbalance valve. This should only be done in extreme cases. The valve must be reset and tested before the crane is returned to normal use.

WARNING!

When the valve setting is decreased, the boom and cylinder may come down suddenly. Do not position yourself under the boom or position any part of your body between the cylinder and boom or between the cylinder and housing.

To decrease the setting, loosen the locknut on the valve, then **SLOWLY** turn the adjustment stem **CLOCKWISE** until the load begins to lower. Count the number of turns so that the valve can be immediately returned to its approximate setting.

Before the crane is returned to regular service, the valve must be precisely set and tested. Contact Liftmoore for exact setting and procedure information. The setting may be tested by lifting a known load near the moment rating.

MANUAL LOWERING OF LOAD

WARNING!

The following procedure should be used in extreme cases only. Improper application of this procedure could result in injury or death.

WARNING!

The following procedure requires adjusting a safety valve. If the valve is not returned to the correct setting it may fail to hold a load, resulting in injury or death.



BASIC TROUBLESHOOTING

The following chart gives a quick reference to help identify and correct problems. Refer to the following pages for more detailed information.

PROBLEM	PROBABLE CAUSE	CORRECTIVE ACTION
NO FUNCTIONS WORK	<p>Not receiving electrical power</p> <p>Not receiving hydraulic power</p> <p>Control problem</p>	<p>Check all connections Check all fuses and circuit breakers Check for electrical power at first electrical connection and trace back to crane</p> <p>Check flow from pump Deadhead cylinder and check pressure at pump</p> <p>See control section</p>
<p style="text-align: center;">FUNCTION NOT WORKING</p> <p style="text-align: center;">winch up, extension out not working</p> <p style="text-align: center;">Boom down, winch down, extension in not working</p> <p style="text-align: center;">Other function not working</p>	<p>No signal from ATB or Load sensor (switch tripped, bad switch, bad wiring or not receiving power)</p> <p>Relay card malfunction</p> <p>Not receiving enough pressure</p> <p>Faulty wiring</p> <p>Valve coils bad</p>	<p>Check input signal to relay board if no signal, trace back to switch</p> <p>Check LEDs on board for error codes and outputs</p> <p>Deadhead cylinder and check pressure at pump Check differential pressure valve for contamination Check relief valve for proper setting and possible contamination</p> <p>Check all wiring for breaks or shorts Check all ground wires for good connection</p> <p>Check coil resistance</p>
<p style="text-align: center;">ALL FUNCTIONS SLOW</p> <p>* These items only apply to cranes with proportional control systems.</p>	<p>Not receiving enough flow</p> <p>Low battery voltage Check with engine running</p> <p>* Proportional valve problem</p> <p>* Control problem</p>	<p>Check fluid levels Check all filters and any other restrictions</p> <p>Charge battery (BATTERY MAY BE BAD)</p> <p>Try manual operation of proportional valve</p> <p>Check voltage at valve for approx. at min and max(see troubleshooting form for specific valves)</p> <p>See control section</p>



TROUBLESHOOTING SAFETY SYSTEM

DTCH Relay Card

To check functions controlled by the safety system check the status indicators. (See Relay Box Assembly drawing.) If only one of the safety functions is not working, activate that function and check for error codes and/or its output status indicator.

For non-FM systems, if the status indicator lights then the problem is in the wiring or in the solenoid coil. If the light does not illuminate, check the control pendant. If the control pendant is good then the crane control module needs to be replaced.

For FM systems, check for error codes. If none are present, see the FM Troubleshooting section.

If boom out, boom down and winch up are not working, confirm that the control board has power. Confirm that the board is receiving a signal from the ATB and load sensor.

If the error code is active, ensure that the crane is not overloaded and that the ATB lever is holding the switch closed. Check for voltage at the ATB and Load Sensor inputs.

CHECK LOAD SENSOR SWITCH

If the load sensor input is not receiving voltage, locate the load sensor connector inside the crane housing. The plug side will have a red wire and a gray wire, the receptacle side will have a red and a white wire.

Disconnect and check for continuity between the two pins on the receptacle (switch side). If there is no continuity then the load sensor is bad and needs to be replaced.

CHECK ATB SWITCH

If the ATB input is not receiving voltage remove the ATB housing cover and disconnect the connector. Check for continuity on the switch side. Lifting the weight should break the continuity. If either of these conditions is incorrect the switch is bad and needs to be replaced.

CHECK CORD REEL

Check the ATB switch if not done so already. Locate the ATB connector inside the crane housing. The plug side will have a red wire and a black wire. The receptacle side will have a white wire and a black wire.

Disconnect the plug going to the switch. Check for continuity between the two pins on the receptacle. Have someone lift the weight on the ATB and continuity should be broken. If either of these conditions are incorrect then the cord reel is bad and needs to be replaced.

CHECK POWER TO SAFETY SWITCHES

If the safety switch is good, check for voltage at pin 1 (the red wire) on the plug. If there is no voltage, follow the wire back to the 6-pin power distribution plug, checking for breaks or shorts.

Remove the power distribution receptacle (cap).

NOTE!

Removing the cap will disconnect power to all electrical components. Be sure to replace the cap before continuing.

Check the cap for bent pins. Check that all wires are fully seated in the plug. If they are not, then remove the green locking wedge and push the wires forward until seated. Reinstall the wedge ensuring that no wires are pushed back.



TROUBLESHOOTING THE PROPORTIONAL SYSTEM

21398 HALL EFFECT, 12V Diplomatic Coil

If no functions work or if all functions are slow when controlled by the pendant, but work correctly when the manual operation button is pressed on the proportional valve then the problem is with the proportional electronic control system.

Proportional Valve Parameters

Cracking voltage	2.6V
Full open voltage	7.75V
Coil Resistance	3.66Ω

CHECK VOLTAGE AT VALVE

Have the engine running to generate sufficient voltage (13-14V). As the trigger is pulled the valve voltage should start near zero, jump to the valve cracking voltage after slight trigger travel, increase steadily as the trigger is pulled, reaching the full open voltage.

If the voltages are correct, check the resistance across the coil. If the resistance differs significantly from the nominal resistance replace the coil.



TROUBLESHOOTING FM CONTROL SYSTEM

Kar-Tech 21318

If the crane does not operate, ensure that both the transmitter and receiver are on. Try disconnecting power to the crane receiver then reconnecting.

Check that the green transmit light on the transmitter and the green receive light on the receiver light up when a function is selected.

When the red and green lights on the transmitter blink simultaneously, the pressure switch is overloaded, and the crane will not elevate down, extend out, and winch up. If the ATB is off, the red and green lights on the transmitter will blink alternately, and the crane will not elevate down and extend out.

Check for error codes and correct as necessary.

NOTE!

Error Code 1 will be active until a signal is received, as indicated by the green light illuminating.

Check that all connectors are secure.

Check for bent pins on the receiver connectors.

If the crane still does not work, try using the CAN cable. If the system works with the CAN cable the problem may be that the batteries on the transmitter are low.

If unable to resolve the problem, please contact Liftmoore, Inc. for further information.

ERROR CODE CHART

	PROBLEM
1	RADIO OR CAN SIGNAL PROBLEM
2	LOW ENGINE BATTERY
3	ATB SWITCH OFF
4	OVERLOAD (PRESSURE SW ON)
5	E-STOP BUTTON PUSHED
6	WRONG TRANSMITTER OR BAD ID
7	TRIGGER ON BEFORE FUNCTION SWITCH
8	TRIGGER PROBLEM
9	FAULTY CIRCUIT TO ROTATION CW
10	FAULTY CIRCUIT TO ROTATION CCW
11	FAULTY CIRCUIT TO EXTENSION OUT
12	FAULTY CIRCUIT TO EXTENSION IN
13	FAULTY CIRCUIT TO BOOM UP
14	FAULTY CIRCUIT TO BOOM DOWN
15	FAULTY CIRCUIT TO HOIST UP
16	FAULTY CIRCUIT TO HOIST DOWN
17	FAULTY CIRCUIT TO PROP OUPUT



DEUTSCH CONNECTIONS & PINS

P/N 30908
PLUG CONTROL 4-PIN



P/N 30635
4 PIN POLLACK

P/N 18753
PLUG 14 PIN DTCH



P/N 18751
SOCKET 14 PIN DEUTSCH

P/N 19916
DTCH 1P PLUG



P/N 19917
DTCH 1P RECPT

P/N 20322
DTCH 5P RECPT PLUG



P/N 20185
DTCH 5P RECPT PLUG
W/ 25' WIRE



FEMALE'S



P/N 19915 CONT. DTCH 20GA

P/N 18757 CONT. DTCH 16 GA

P/N 19918 CONT. DTCH 12 GA

P/N 19935
SEALING PLUG DTCH 20GA



P/N 21285
BUSS DTCH 12P RECPT 12PB



P/N 19854
WEDGE DEUTSCH 12P PLUG



MALE'S



P/N 20771 CONT. DTCH 20GA

P/N 18756 CONT. DTCH 16 GA

P/N 19919 CONT. DTCH 12 GA

P/N 18758
SEALING PLUG DTCH 16GA



P/N 19853
DTCH 12P-B PLUG



P/N 19857
DTCH 6P RECPT BUSS



P/N 19850
WEDGE DTCH 6P PLUG



P/N 19846
WEDGE, DEUTSCH 2P PLUG



P/N 19847
DTCH 2P PLUG

P/N 19909
WEDGE DTCH DTM
12P-A PLUG



P/N 19849
CONNECTOR, DTCH 6P PLUG



P/N 19845
DTCH 2P RECPT

P/N 19848
WEDGE, DEUTSCH 2P RECPT



P/N 19908
DTCH DTM 12P-B PLUG



P/N 19907
DTCH DTM 12P-A PLUG



RED RING INSUL
P/N 18770 22-18GA #10



BLU RING INSUL
P/N 15802 14-16GA #8
P/N 15736 14-16GA #10
P/N 21478 14-16GA 0.25
P/N 15871 14-16GA 0.31



YEL RING INSUL
P/N 16781 10-12GA #8
P/N 16111 10-12GA 0.25
P/N 15771 10-12GA 0.31
P/N 26725 14-16GA .437



BRAZED RING
P/N 15837 4GA 0.31
P/N 15563 6GA 0.25
P/N 15148 6GA 0.31
P/N 15737 1/0GA 0.31



LUG RING
P/N 16915 #1GA 0.25
P/N 17063 #1GA 0.37
P/N 16922 #4GA 0.25
P/N 17064 #4GA 0.37
P/N 16923 #1/0GA 0.25
P/N 17062 #1/0GA 0.37



QUICK SPLICE
P/N 31407 14-18GA (TAN)
P/N 32141 18-22GA (RED)

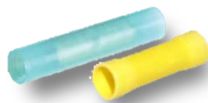

BUTTED CONN
P/N 15565 14-16GA (BLU)
P/N 16110 10-12GA (YLVW)



FUSE CONN.
P/N 19921 HOLDER 16GA
P/N 18456 15AMP BLADE

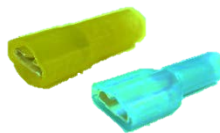

FEMALE TERM
P/N 15797 10-12GA (YLVW)
P/N 15566 14-16GA (BLU)



MALE TERM
P/N 15838 10-12GA (YLVW)
P/N 32118 14-16GA (BLU)

THIS PAGE INTENTIONALLY LEFT BLANK

SECTION 3 CRANE SPECIFICATIONS MODEL 4075 CRANES

MOMENT RATING 40 000 FT-LBS

MAX SINGLE LINE LOAD 3,750 LBS

MAX DOUBLE LINE LOAD 7,500 LBS

LIFTING CAPACITIES AT VARIOUS LOAD RADII

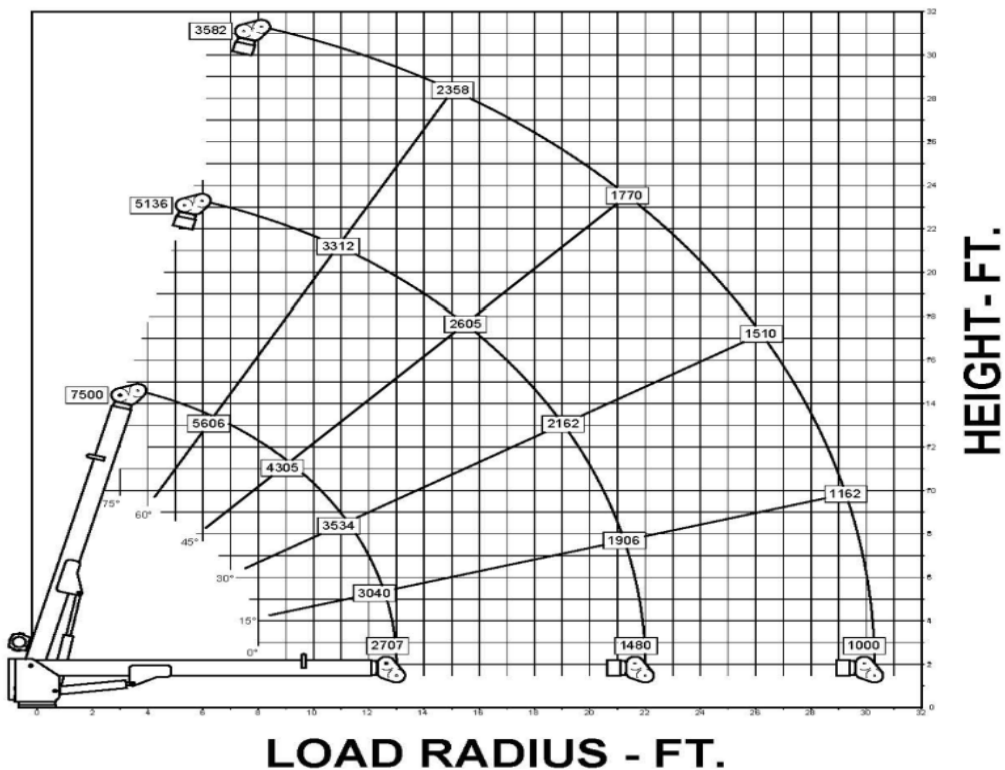

POWERED FUNCTIONS AND EXPECTED TIMES

WINCH	UP: 3.3s	DOWN: 3.8s	1 REVOLUTION
BOOM ELEVATION	UP: 20s	DOWN: 20s	
BOOM EXTENSION	OUT: 41s	IN: 33s	
ROTATION	90° 15s		

HYDRAULIC REQUIREMENTS

PRESSURE	2750 PSI
FLOW	6 GPM

ELECTRICAL REQUIREMENTS

VOLTAGE	12 VDC
FUSE	15 AMP

NOTE: FUNCTION TIMES ARE BASED ON THESE INPUT VALUES



F2651-0
3/26/20

HOUSTON, TEXAS
FAX: (800) 824-5559 (USA & Canada)
FAX: (713) 688-6324
PHONE: (713) 688-5533
www.liftmoore.com

PERIODIC MAINTENANCE SCHEDULE MODEL 4075 CRANES		
BOLTS		
MOUNTING BOLTS	7/8-9 GRADE 8 TORQUE 600FT-LBS DRY	EVERY 4 MONTHS
BEARING BOLTS (REFER TO BASE-HOUSING ASSEMBLY)	5/8-11 GRADE 8 TORQUE 170FT-LBS DRY	EVERY 4 MONTHS
LUBRICATION		
GREASE FITTINGS	SEE DRAWING 50048	EVERY OTHER WEEK
HYDRAULIC FLUID	STANDARD Chevron AW Hydraulic Oil 46 or equivalent SAE 15 weight oil COLD WEATHER AW 32 or equivalent SAE 10 weight oil	CHECK DAILY, FILL AS NEEDED
WINCH GEARBOX	HLP ISO VG 46	EVERY MONTH
ROTATION GEARBOX	EP 01 Grease	EVERY MONTH
BEARING (ZERK AND TEETH)	Oil Center Research PM 600 Military grease or equivalent Benton Based Grease NLGI Grade 2	EVERY 6 HOURS OF OPERATION



CRANE LUBRICATION POINTS

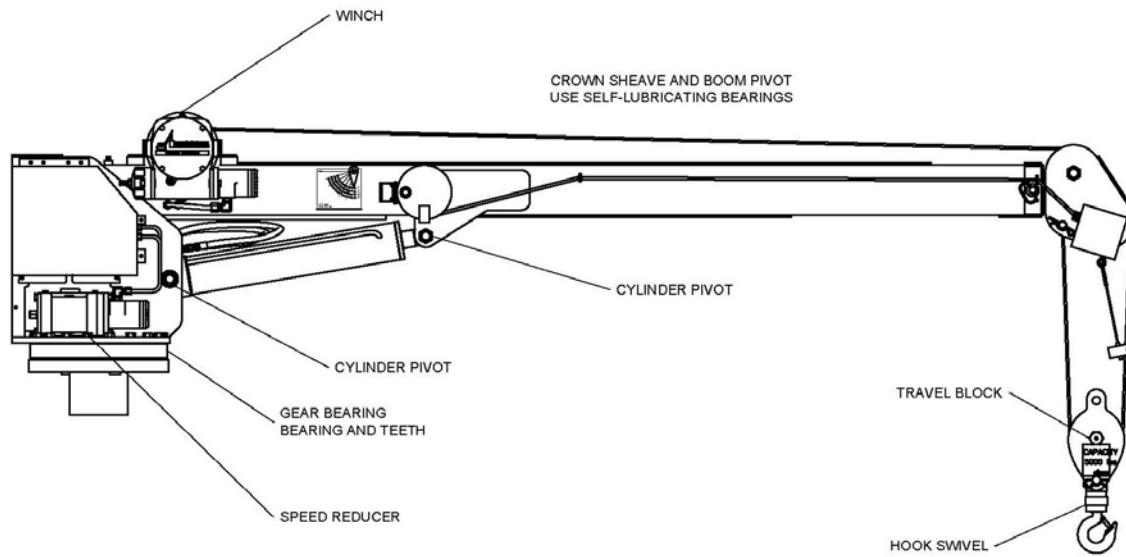

THIS PAGE INTENTIONALLY LEFT BLANK



F2651-0
3/26/20

HOUSTON, TEXAS
FAX: (800) 824-5559 (USA & Canada)
FAX: (713) 688-6324
PHONE: (713) 688-5533
www.liftmoore.com

LIST FOR BOX, CRANE PARTS 4075XP KTG

Items with * have detailed DWG's.

P/N 29246 - BOX, CRANE PARTS 4075DXP-30 KTG

- 1) P/N 29245 - MANUAL, CRANE 40675DXP-30.....1pc
- 2) P/N 19847 – CW, 10 GA X 300”.....1pc
- 3) P/N 18457 – FUSE, HOLDER, ATO 12 GA SEALED.....1pc
- 4) P/N 21154 – FUSE, 30AMP BLADE.....1pc
- 5) P/N 32613 – ADAPTER, 8MJ-10MJ.....1pc
- 6) P/N 17102 – SWITCH, TOGGLE SPST MAIN.1pcs
- 7) P/N 17011 – BRACKET, SWITCH MNT. HYD. GRN.....1pcs
- 8) P/N 16781 – TERMINAL, RING 10-12 GA #8..... 2pcs
- 9) P/N 17013 – PLATE, ON/OFF FOR TOGGLE SWCH.....1pcs
- 10) P/N 18600 - PLATE, CRANE-TRUCK STABILITY CHART..... 1pc
- 11) P/N 29252 – DECAL, LOAD CAPACITY 40,000..... 1pc
- 12) P/N 23144 – LEVEL AND TAPE ASSEMBLY 1pc
- 13) P/N 30675 – COVER, TOGGLE SWITCH.....1pc
- 14) P/N 70053 – NUT, TOGGLE SWITCH..... 1pc
- 15) P/N 70054 – WASHER, LOCK TOGGLE SWITCH.....1pc
- 16) P/N 70055 – SCREW, MH FH 6-32 X 0.25.....2pc
- 17) P/N 28836 – WIRE, GROUND #6 X 60” W/TRM.....1pc



F2653-0
3/26/20

HOUSTON, TEXAS
 FAX: (800) 824-5559 (USA & Canada)
 FAX: (713) 688-6324
 PHONE: (713) 688-5533
 www.liftmoore.com

-NOTE: INSTALL P/N 25704 WHITE/RED REFLECTIVE TAPE ON TOP CORNER ON BOTH SIDES OF EACH BOOM BELOW

2ND INNER INSTALL 1" BACK FROM EDGE OF BOOM QTY-80"
1ST INNER INSTALL 1" BACK FROM END OF PLATE QTY-80"

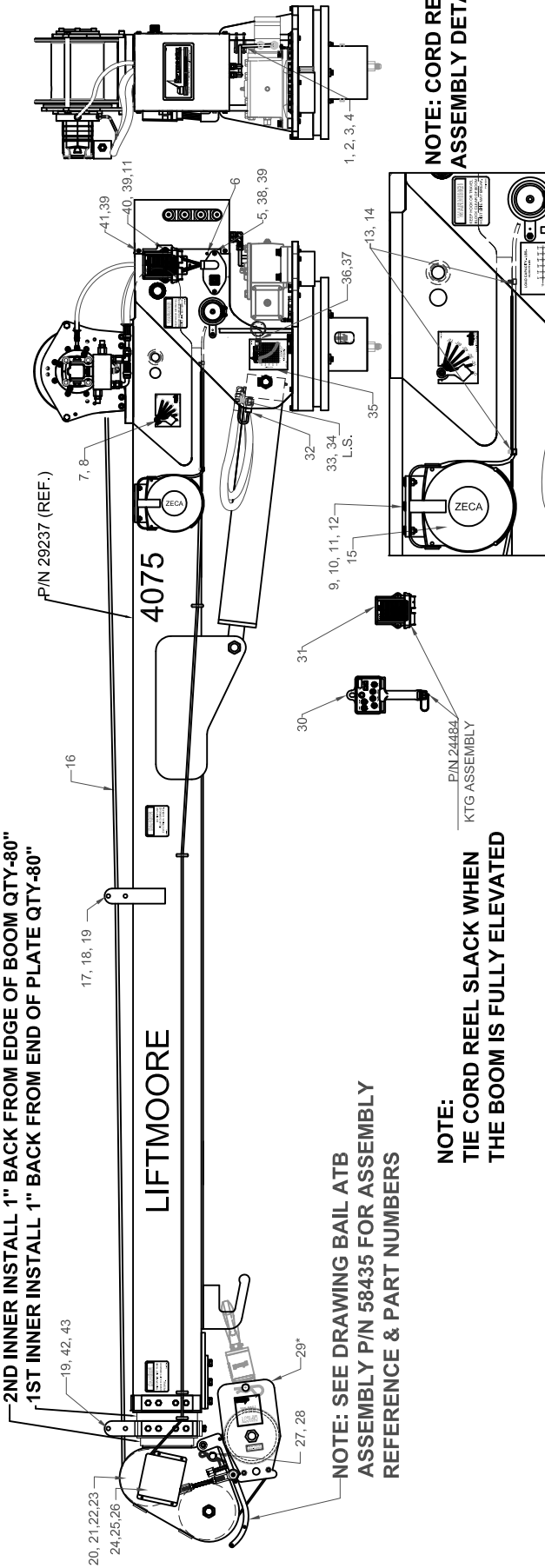

NOTE: SEE DRAWING BAIL ATB ASSEMBLY P/N 58435 FOR ASSEMBLY REFERENCE & PART NUMBERS

NOTE: TIE CORD REEL SLACK WHEN THE BOOM IS FULLY ELEVATED

ITEMS WITH * HAVE DETAIL DRAWINGS

#	PN	DESCRIPTION	QTY	#	PN	DESCRIPTION	QTY	#	PN	DESCRIPTION	QTY
1	22386	SPACER, ELEV SWITCH MACH	1	19	30835	NUT, HEX NYLOC 0.50-13 GRADE 5	4	37	23135	ADAPTER, 4FP-6FJX SWIVEL	1
2	20413	SWITCH, LIMIT UP 2WNC-20 DTCH	1	20	20541	SHEAVE ASSY 6.58PD X 0.37 ROPE	2	38	30809	SCREW, HHC 0.25-20 X 0.50 GR5	2
3	22392	SCREW, SOC HD 10-24 X 2.50 SS	2	21	34468	SCREW, SHEAVE SINGLE 1-8 3.25	2	39	30889	WASHER, LOCK 0.25-20 X 0.50 GR5	6
4	33409	NUT, HEX NYLOC 10-24 GR2	2	22	30838	NUT, HEX NYLOC 1.00-8 GRADE 5	2	40	30810	SCREW, HHC 0.25-20X1.00 GR5	2
5	25697	EWH, DTCH HYD 4064XP ATB-BD	1	23	31258	WASHER, FLAT 1.00 SAE GRADE 8	2	41	30809	SCREW, HHC 0.25-20 X 0.50 GR5	4
6	30989	SCREW, HWHMS #8 X 0.50	1	24	27192	COVER, BAIL ATB	1	42	26668	ROLLER, ROPE 2550/4064 NYLON	1
7	22394	PENDULUM, LOAD RADIUS DIA. HD	2	25	26909	SCREW, SOC HD 10-24 X 0.37 SS	4	43	30809	SCREW, HHC 0.50-13 X 7.50 GR8	2
8	31017	SCREW, SHOULDER 0.31-18 X 0.75	2	26	26910	WASHER, FLAT #10 SS	4		NOT SHOWN: FM PARTS		
9	70052	BRACKET, CORD REEL	1	27	32658	PIN, CLEVIS 0.87 X 3.50 PLATED	1		20185	WIRE, CTRL FM TEATHER 5P PLUG	1
10	30833	NUT, HEX NYLOC 0.25-20 GR2	2	28	31948	CLIP, HAIRPIN 0.87 - 1.00	1		20186	12V CHARGER, FM TRANS	1
11	31110	WASHER, FLAT 0.25 GR5 PLATED	3	29	29259	BLOCK, TRAV ASSY 7.5 lbs/6.5D	1		NOT SHOWN:		
12	30810	SCREW, HHC 0.25-20 X 1.00 GR5	3	30	24453	CONTROL, FM TRANS HYD XP DRAK	1		19847	CONNECTOR, DTCH 2P PLUG	1
13	26582	SCREW, SOC HD 0.25-20 X 0.37 SS	3	31	24454	CONTROL, FM RECEIVER XP HE	1		19845	CONNECTOR, DTCH 2P RECPT	1
14	24960	CLAMP, HOSE SUPPORT 0.25	2	32	22431	SWITCH, PRES ASSY 2700PSI DTCH	1		19846	WEDGE, DEUTSCH 2P PLUG	1
15	25862	REEL, CORD 34 FT ZECA ASSY DTCH	1	33	22391	SCREW, S.WALK 0.25-20 X 1.0 SS	1		19848	WEDGE, DEUTSCH 2P RECPT	1
16	24349	ROPE, WIRE 0.375 X 115 W/THIMBLE	1	34	22390	NUT, HEX JAM 0.25-20 SS	1		19916	CONNECTOR, DTCH 1P PLUG	1
17	21631	ROLLER, ROPE 4064 NYLON	1	35	29251	PLATE, SERIAL 4075	1		29250	DECAL KIT 4064	1
18	21634	SCREW, HHC 0.50-13 X 8.50 PLT	2	36	23123	PRESSURE, GAUGE 0-3000 PSI	1				

Houston TX
 (713)-688-5533
 www.liftmoore.com

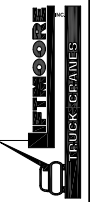

CRANE ASSY 4075DXP-30 KTG
 CURVED BAIL, HOOK

DRAWING NO.
29244-0

DRWN BY: JE
 DATE: 1/22/20

P/N 24453 CONTROL, FM TRANS HYD XP DRA K

P/N 24454 CONTROL, FM RECEIVER XP HE

NOT SHOWN:

P/N 20185 WIRE, CTRL FM TEATHER 5P PLUG
 P/N 20186 CAR CHARGER, FM TRANS

TRANSMITTER AND RECEIVERS ARE PROGRAMMED TO FORM A MATCHED SET SO THAT A TRANSMITTER ONLY OPERATES ONE CRANE. IF EITHER PART IS REPLACED, THE RECEIVER MUST BE PROGRAMMED TO THE TRANSMITTER USING A TEMPORARY WIRING HARNESS AVAILABLE FROM LIFTMOORE.

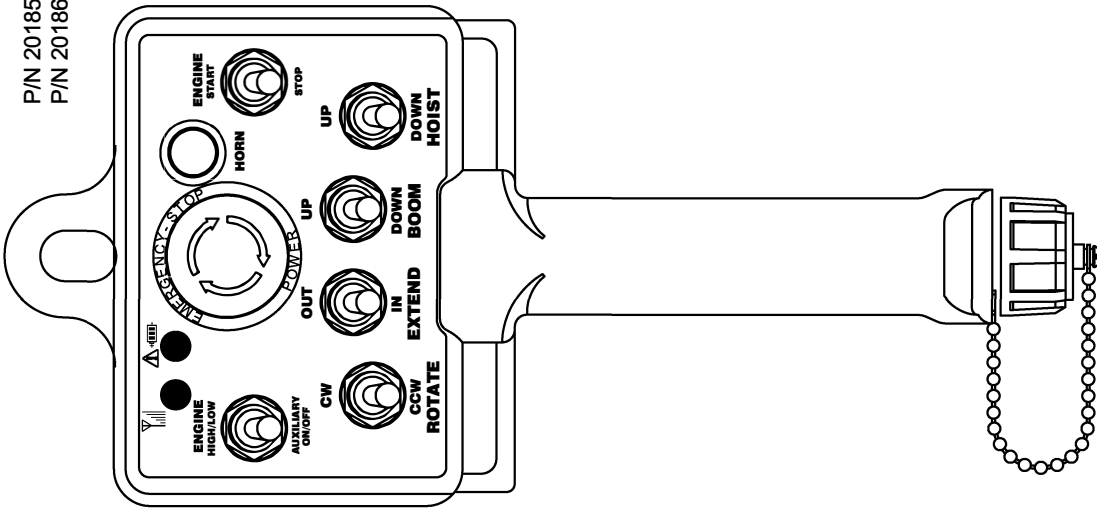

P1:12 PIN DEUTSCH DTM13-12PA

PIN#	DESCRIPTION	COLOR
1	GROUND	BRN
2	CAN HIGH	WHT
3	CAN LOW	GRN
4	PROGRAMMING PIN	
5	ATB SWITCH IN (DI2)	YEL/BLK
6	PRESSURE SWITCH IN (ANO) BLU/BLK	BLU/BLK
7	NO CONNECTION	
8	PRESSURE TRANSDUCER IN (AN2)	
9	NO CONNECTION	
10	NO CONNECTION	
11	HORN ON PUT	
12	POWER (9 TO 35 VDC)	RED

P2:12 PIN DEUTSCH DTM13-12PB

PIN#	DESCRIPTION	COLOR
1	ROTATION CW OUTPUT	RED
2	ROTATION CCW OUTPUT	RED/BLK
3	EXTENSION OUT OUTPUT	ORN/BLK
4	EXTENSION IN OUTPUT	GRN/BLK
5	BOOM UP OUTPUT	GRN
6	BOOM DOWN OUTPUT	ORN
7	HOIST UP OUTPUT	BLU
8	HOIST DOWN OUTPUT	BLK
9	PROPORTIONAL	WHT/BLK
10	RS232 GND (PALM PILOT)	
11	RS232 RX (PALM PILOT)	
12	RS232 TX (PALM PILOT)	

OPTIONAL:

P/N 24510 INTERNATIONAL WALL CHARGER 110V

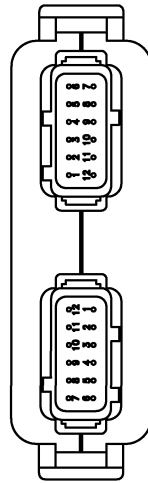
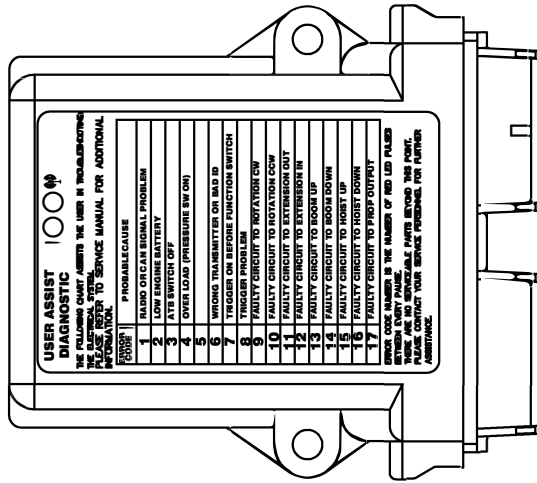

Houston TX
 (713)-688-5533
 www.liftmoore.com



DRWN BY: JE
 DATE: 4/21/11

BOX, FM RECEIVER XP KT GUIDER
 WITH HORN OUTPUT

DRAWING NO.

24484-A

P/N 24455 CONTROL, FM RECEIVER ENG/AUX GUIDER

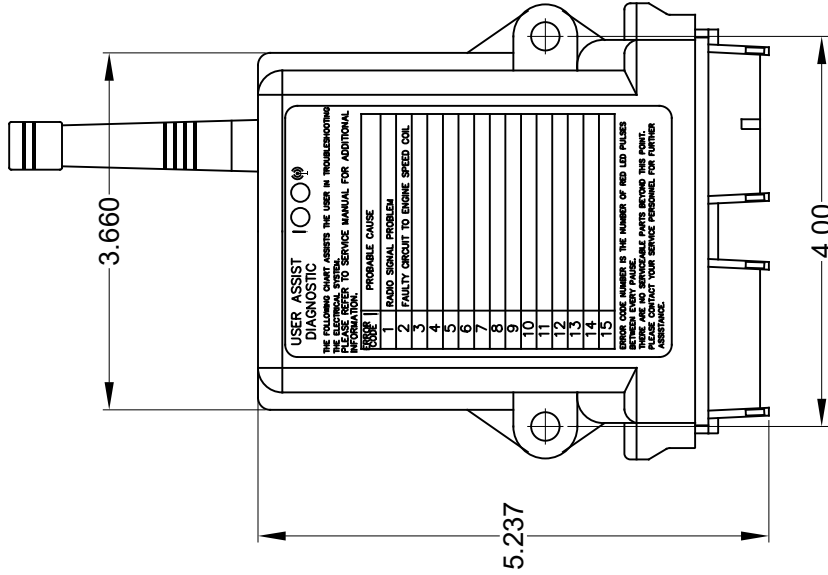

P/N 21336 EWH, ENGINE CTRL RCVR KTFM DRA

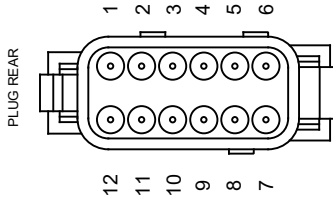
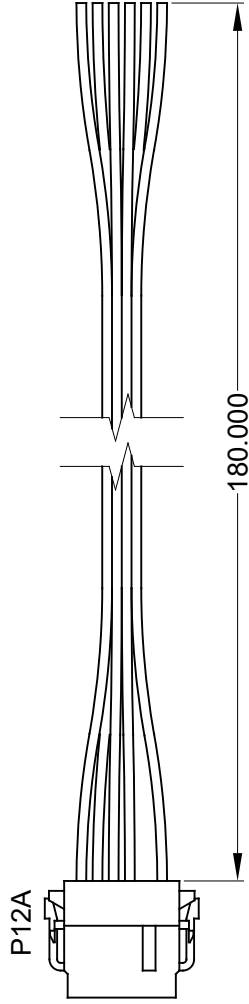

P12A - ENGINE RECEIVER			
PIN	COLOR	DESC	FUNCTION
1	BLK	GRND	
8	YEL/BLK	AUX	12v OUT MOMENTARY
9	BRN	ENG START	12v OUT MOMENTARY
10	GRY	ENG STOP	12v OUT MOMENTARY
11	BLU/BLK	ENG HI IDLE/PTO	12v OUT LATCHING
12	RED	PWR	12v POWER SUPPLY
SEAL PIN IN ALL OTHER CONTACTS			
SUPPLY VOLTAGE TO PIN 5 TO CHANGE PIN 11(ENG HI IDLE/PTO) TO MOMENTARY			

J12A NO CONNECTION

J12B

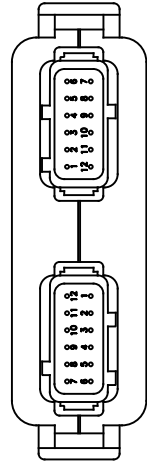

SEE FORM 1214 FOR GENERAL INFORMATION ON INTERFACING WITH ECM AND CONTACT INFORMATION FOR VEHICLE AND ENGINE MANUFACTURERS



Houston TX
(713)-688-5533
www.iftmoore.com

FM ENGINE CONTROL REPRESENTATION
WITH AUXILIARY FUNCTION, 3RD GEN KTFM GUIDER

DRAWING NO.

24455-B

ASSEMBLY

REPORT ANY ERRORS OR CHANGES
TO ENGINEERING IMMEDIATELY

NOTE

CROWN PLATE FOR
REFERENCE ONLY

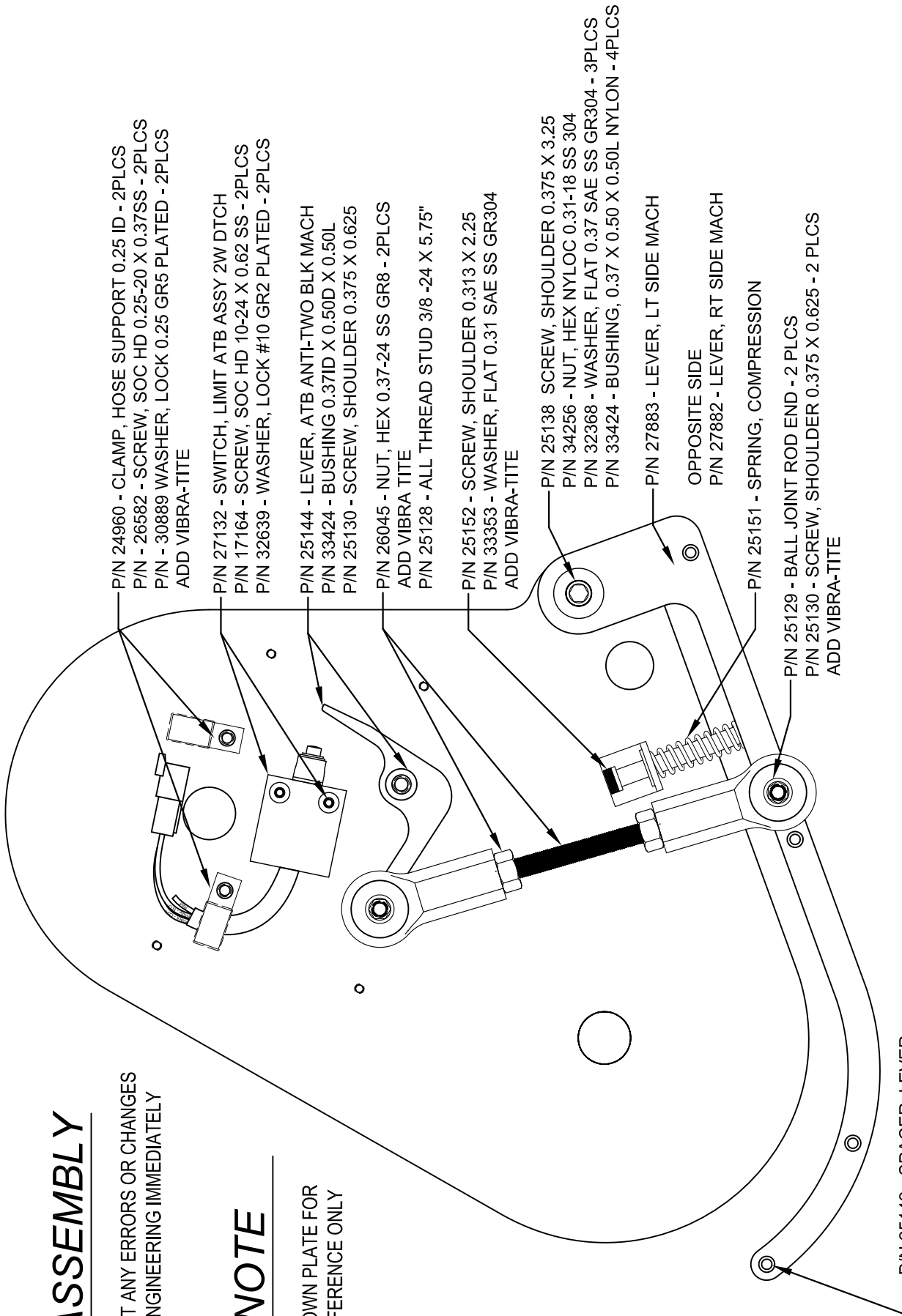

- P/N 24960 - CLAMP, HOSE SUPPORT 0.25 ID - 2PLCS
- P/N - 26582 - SCREW, SOC HD 0.25-20 X 0.37SS - 2PLCS
- P/N - 30889 WASHER, LOCK 0.25 GR5 PLATED - 2PLCS
ADD VIBRA-TITE
- P/N 27132 - SWITCH, LIMIT ATB ASSY 2W DTCH
- P/N 17164 - SCREW, SOC HD 10-24 X 0.62 SS - 2PLCS
- P/N 32639 - WASHER, LOCK #10 GR2 PLATED - 2PLCS
- P/N 25144 - LEVER, ATB ANTI-TWO BLK MACH
- P/N 33424 - BUSHING 0.37ID X 0.50D X 0.50L
- P/N 25130 - SCREW, SHOULDER 0.375 X 0.625
- P/N 26045 - NUT, HEX 0.37-24 SS GR8 - 2PLCS
ADD VIBRA TITE
- P/N 25128 - ALL THREAD STUD 3/8 -24 X 5.75"
- P/N 25152 - SCREW, SHOULDER 0.313 X 2.25
- P/N 33353 - WASHER, FLAT 0.31 SAE SS GR304
ADD VIBRA-TITE
- P/N 25138 SCREW, SHOULDER 0.375 X 3.25
- P/N 34256 - NUT, HEX NYLOC 0.31-18 SS 304
- P/N 32368 - WASHER, FLAT 0.37 SAE SS GR304 - 3PLCS
- P/N 33424 - BUSHING, 0.37 X 0.50 X 0.50L NYLON - 4PLCS
- P/N 27883 - LEVER, LT SIDE MACH
- OPPOSITE SIDE
- P/N 27882 - LEVER, RT SIDE MACH
- P/N 25151 - SPRING, COMPRESSION
- P/N 25129 - BALL JOINT ROD END - 2 PLCS
- P/N 25130 - SCREW, SHOULDER 0.375 X 0.625 - 2 PLCS
ADD VIBRA-TITE

- P/N 25142 - SPACER, LEVER
- P/N 27885 - LEVER, BAIL SUPPORT - MACH - 2PLCS
- P/N 17164 - SCREW, SOC HD 10-24 X 0.62 SS - 8PLCS
ADD VIBRA-TITE

	Houston TX (713)-688-5533 www.liftmoore.com	DRWN BY: AA DATE: 02/25/16	DWG, BAIL ATB ASSEMBLY 6036/3660/4064/5080 BAIL ATB
			DRAWING NO. 58435-E

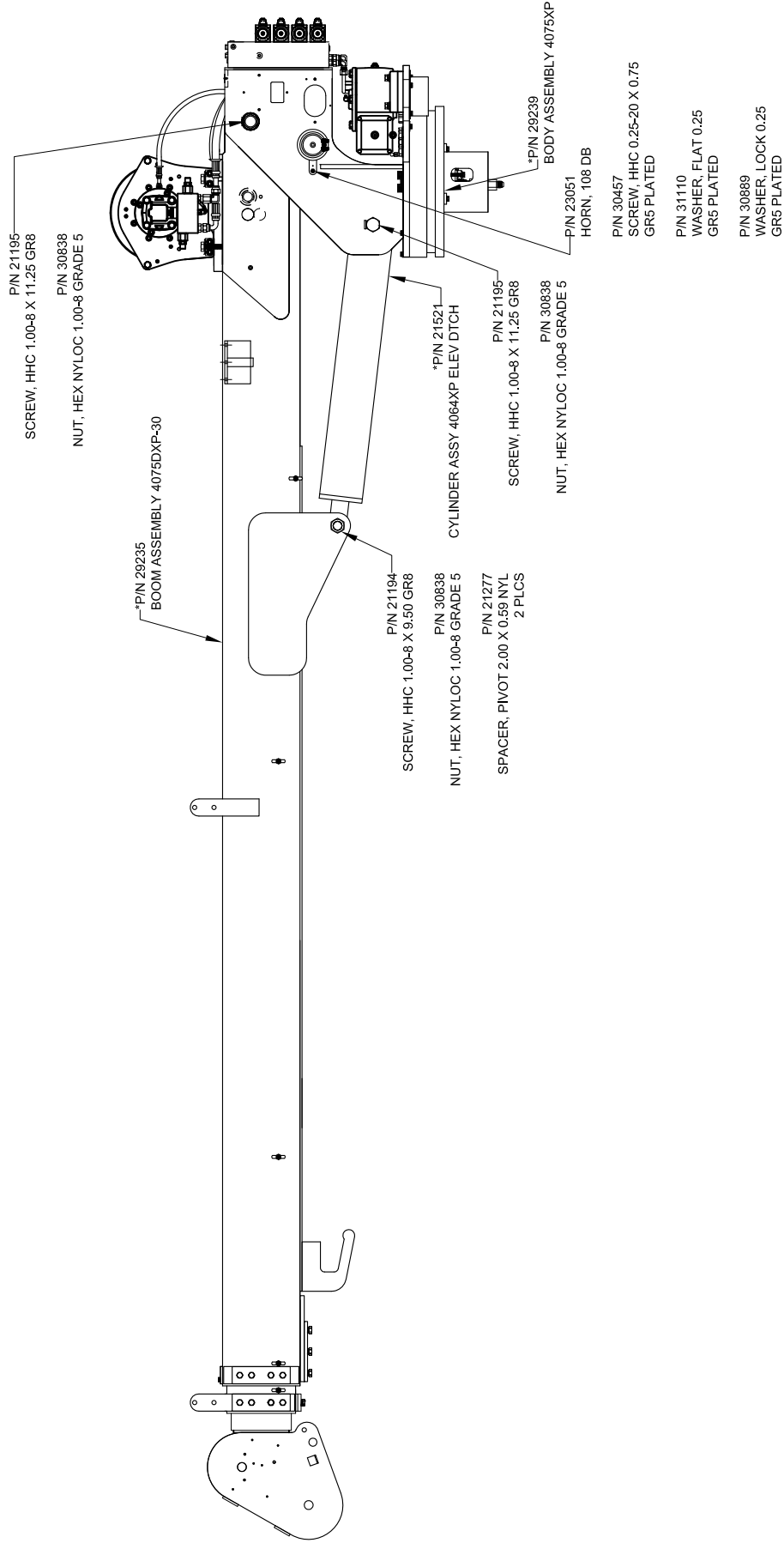

DRAWING NO.
29237-0

BOOM-BODY ASSY 4075DXP-30

DRWN BY: JE
DATE: 1/21/20

Houston TX
(713)-688-5533
www.liftmoore.com



SWITCH, PRES ASSY
(NOT PART OF ASSEMBLY).
SEE CRANE ASSEMBLY DRAWING FOR PART NUMBER

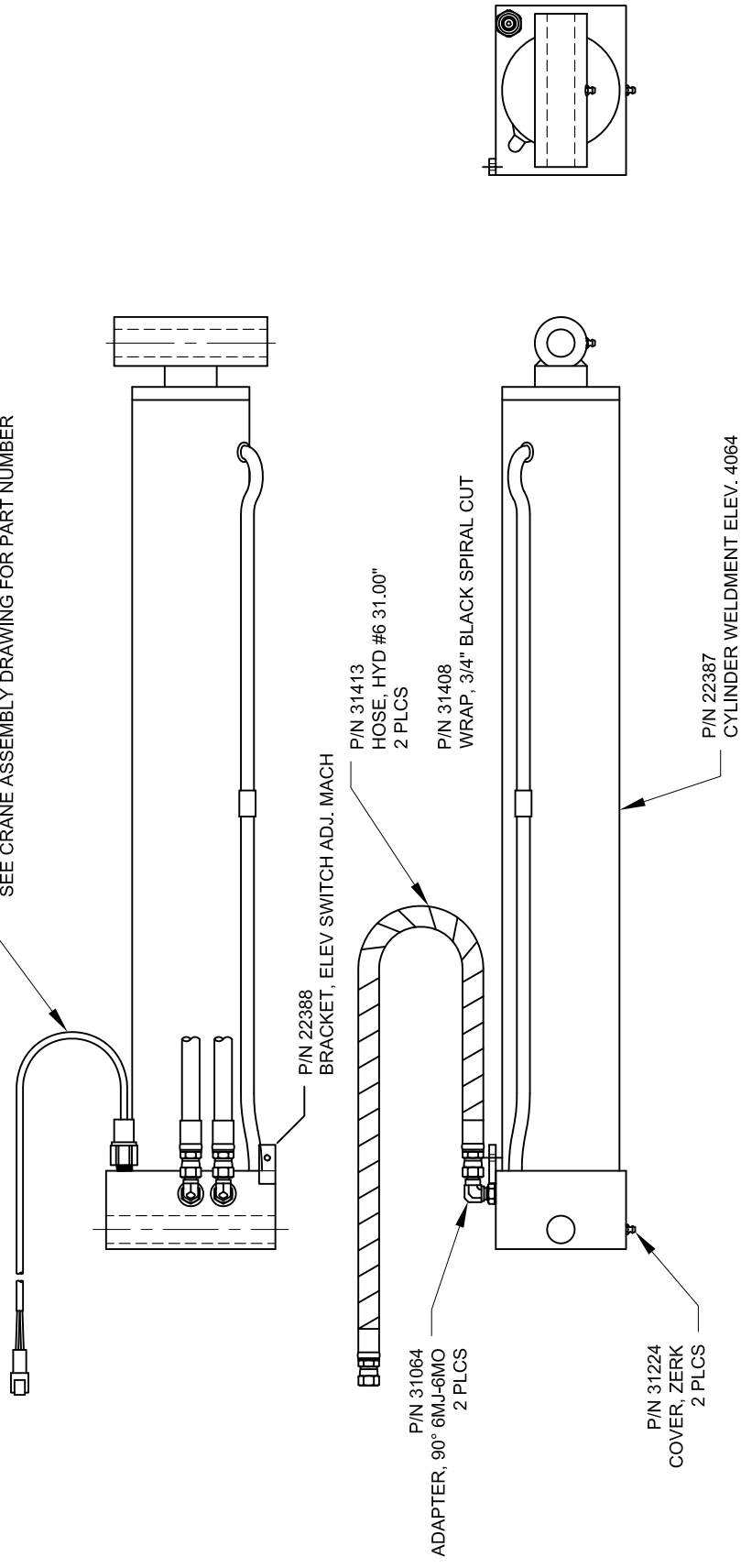

REPLACEMENT PARTS FOR CYLINDER	
DESCRIPTION	PART NUMBER
SEAL KIT	TM*SK-00271
COUNTER BALANCE VALVE	18577
P.O. CHECK VALVE PLUG	TM*PP00482
CYLINDER, 4.5 X 24.0 X 2.0 POC	18301

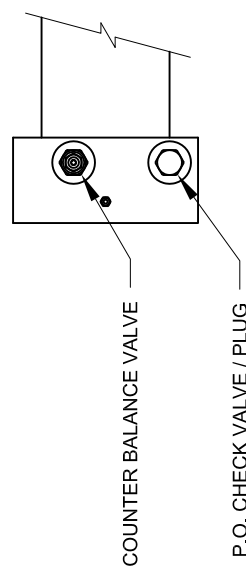

DRAWING NO.
21521-E

CYLINDER ASSY 4064XP ELEV DTCH
CYL 18301,35.50" HOSE,DTCH LS

DRWN BY: JC
DATE: 09/30/09

Houston TX
(713)-688-5533
www.liftmoore.com



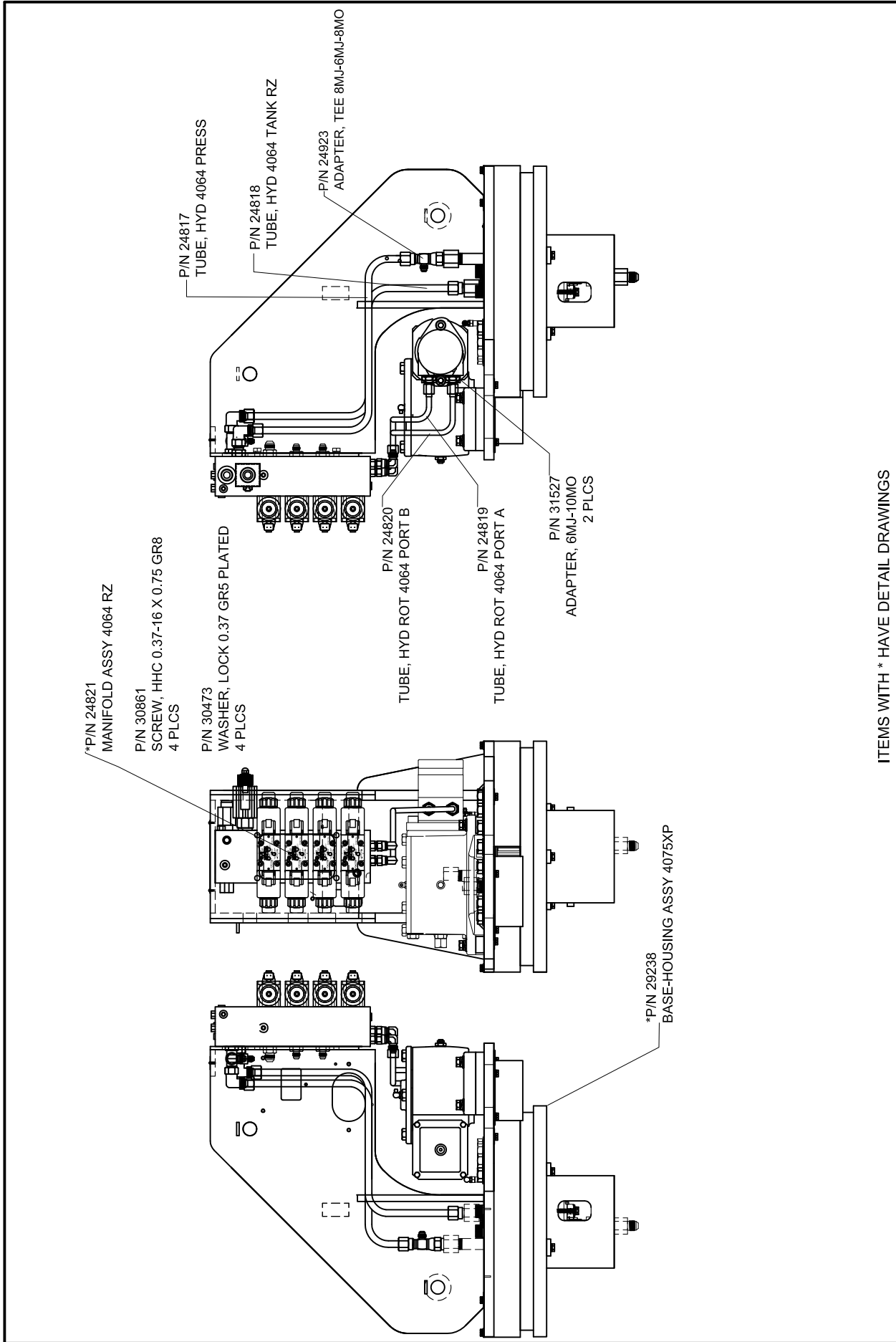

ITEMS WITH * HAVE DETAIL DRAWINGS

DRAWING NO.
29239-B

BODY ASSEMBLY 4075XP

DRWN BY: JE

DATE: 1/21/20

Houston TX
(713)-688-5533
www.liftmoore.com

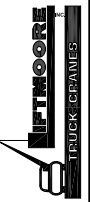

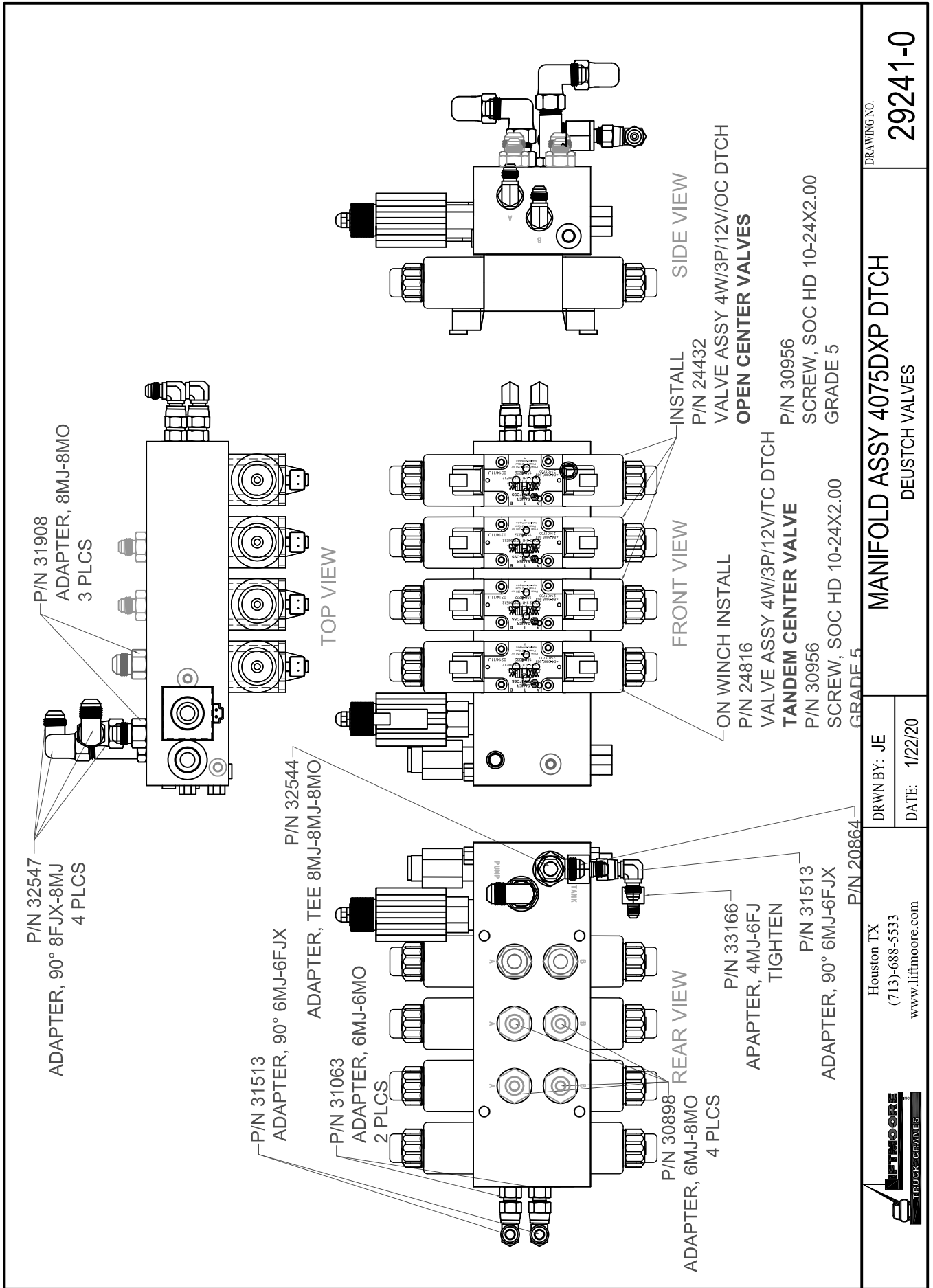

Houston TX
(713)-688-5533
www.liftmoore.com

DRWN BY: JE
DATE: 1/22/20

DRAWING NO.
29241-0

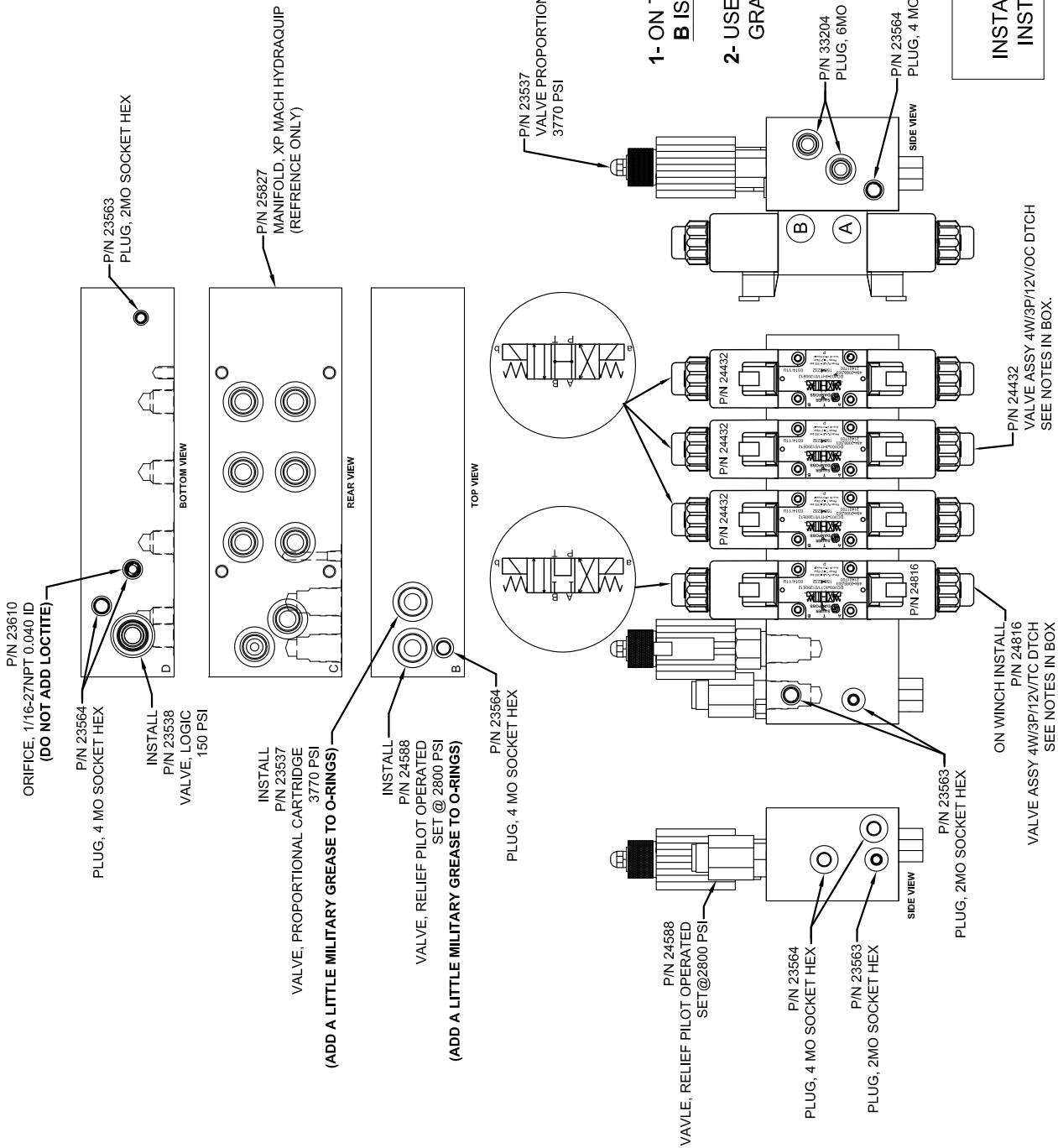

NOTES

- 1- ON THE SIDE OF THE VALVE MAKE SURE **B** IS ON TOP & **A** ON THE BOTTOM.
- 2- USE P/N 30956 - SCREW, SOC HD 10-24X2.00. GRADE 5

NOTES
 INSTALL 3 VALVES P/N 24432 ON RIGHT
 INSTALL 1 VALVE P/N 24816 ON LEFT

	Houston TX (713)-688-5533 www.liftmoore.com	DRAWN BY: JE DATE: 1/22/20	DRAWING NO. 29240-0
	MANIFOLD PRE ASSY XP DTCH TANDEM CENTER VALVE		

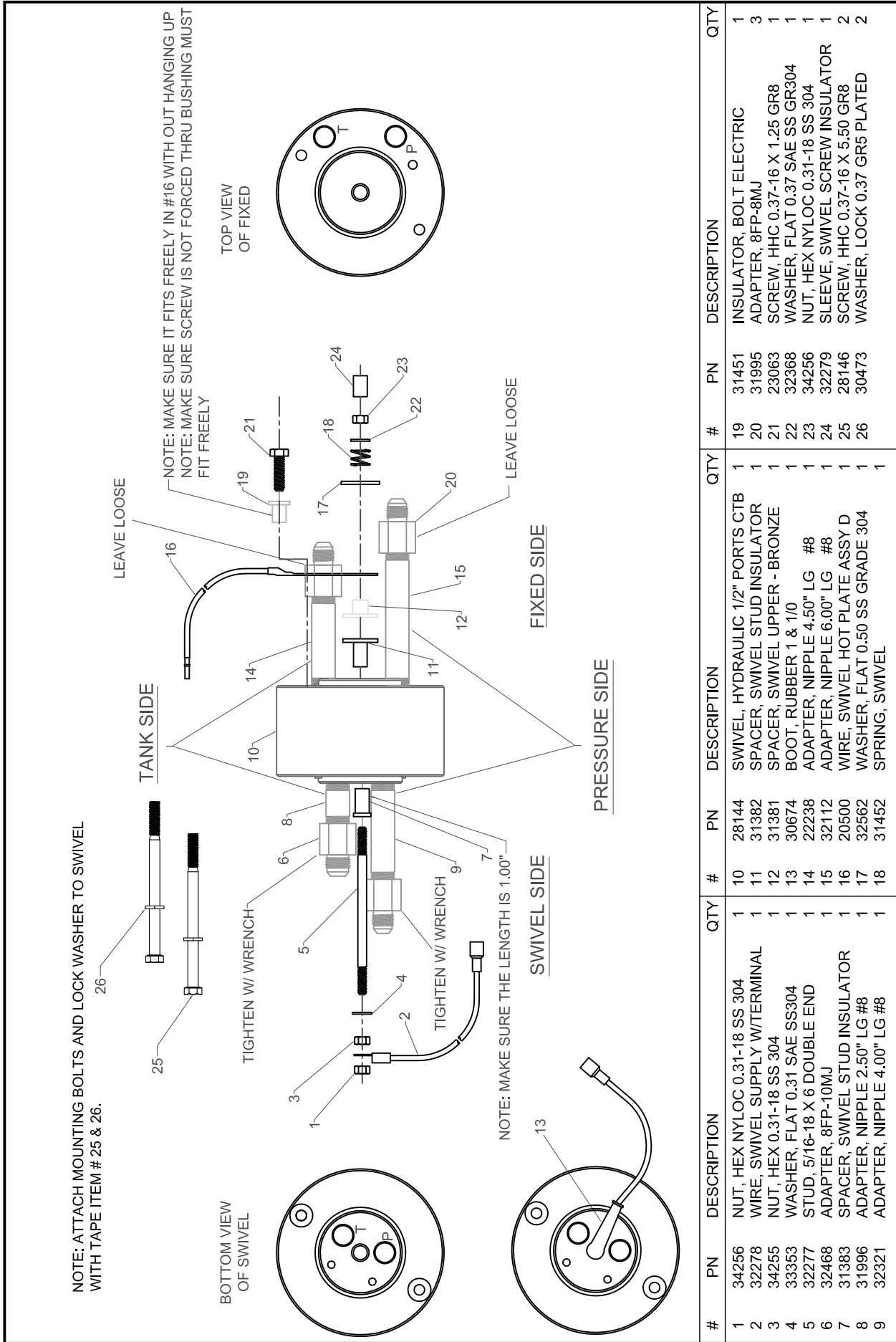

#	PN	DESCRIPTION	QTY	#	PN	DESCRIPTION	QTY	#	PN	DESCRIPTION	QTY
1	34256	NUT, HEX NYLOC 0.31-18 SS 304	1	10	28144	SWIVEL, HYDRAULIC 1/2" PORTS CTB	1	19	31451	INSULATOR, BOLT ELECTRIC	1
2	32278	WIRE, SWIVEL SUPPLY W/TERMINAL	1	11	31382	SPACER, SWIVEL STUD INSULATOR	1	20	31995	ADAPTER, 8FP-8MJ	3
3	34255	NUT, HEX 0.31-18 SS 304	1	12	31381	SPACER, SWIVEL UPPER - BRONZE	1	21	23063	SCREW, HHC 0.37-16 X 1.25 GR8	1
4	33353	WASHER, FLAT 0.31 SAE SS304	1	13	30674	BOOT, RUBBER 1 & 1/0	1	22	32368	WASHER, FLAT 0.37 SAE SS GR304	1
5	32277	STUD, 5/16-18 X 6 DOUBLE END	1	14	22238	ADAPTER, NIPPLE 4.50" LG #8	1	23	34256	NUT, HEX NYLOC 0.31-18 SS 304	1
6	32468	ADAPTER, 8FP-10MJ	1	15	32112	ADAPTER, NIPPLE 6.00" LG #8	1	24	32279	SLEEVE, SWIVEL SCREW INSULATOR	1
7	31383	SPACER, SWIVEL STUD INSULATOR	1	16	20500	WIRE, SWIVEL HOT PLATE ASSY D	1	25	28146	SCREW, HHC 0.37-16 X 5.50 GR8	2
8	31996	ADAPTER, NIPPLE 2.50" LG #8	1	17	32562	WASHER, FLAT 0.50 SS GRADE 304	1	26	30473	WASHER, LOCK 0.37 GR5 PLATED	2
9	32321	ADAPTER, NIPPLE 4.00" LG #8	1	18	31452	SPRING, SWIVEL	1				



Houston TX
 (713)-688-5533
 www.iftmoore.com

DRWN BY: JE
 DATE: 8/11/16

SWIVEL, HYD/ELEC ASSY SHORT CTB
 COUNTER BORE MOUNTING HOLES

DRAWING NO.

28145-0

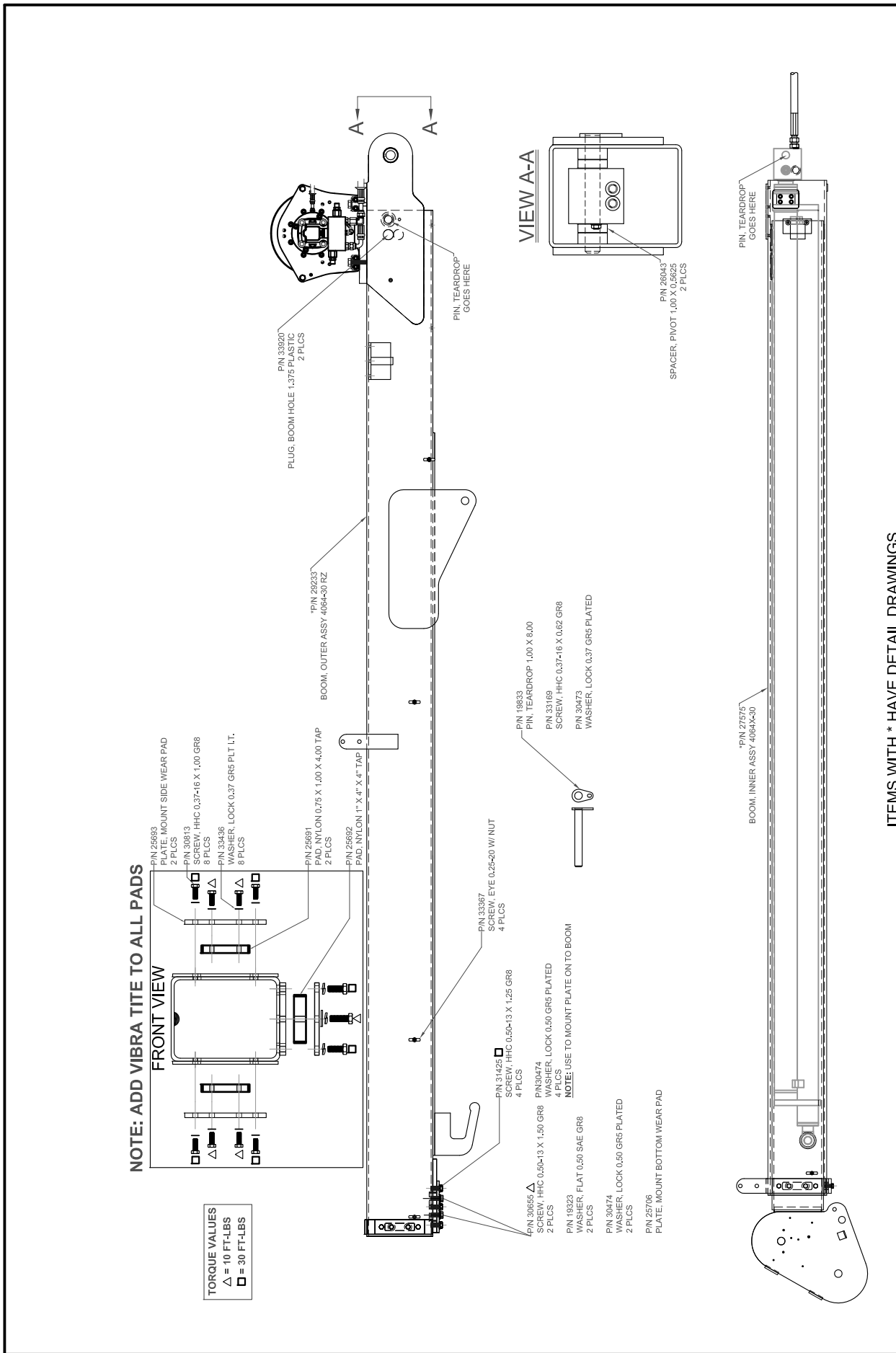

BOOM ASSEMBLY 4075DXP-30
DYNAMIC OIL WINCH

DRAWING NO. **29235-0**

HOUSTON TX (713)-688-5533 www.liftmoore.com	DRWN BY: JE DATE: 1/20/20	
---	------------------------------	--

LIFTMOORE
TRUCK CRANES

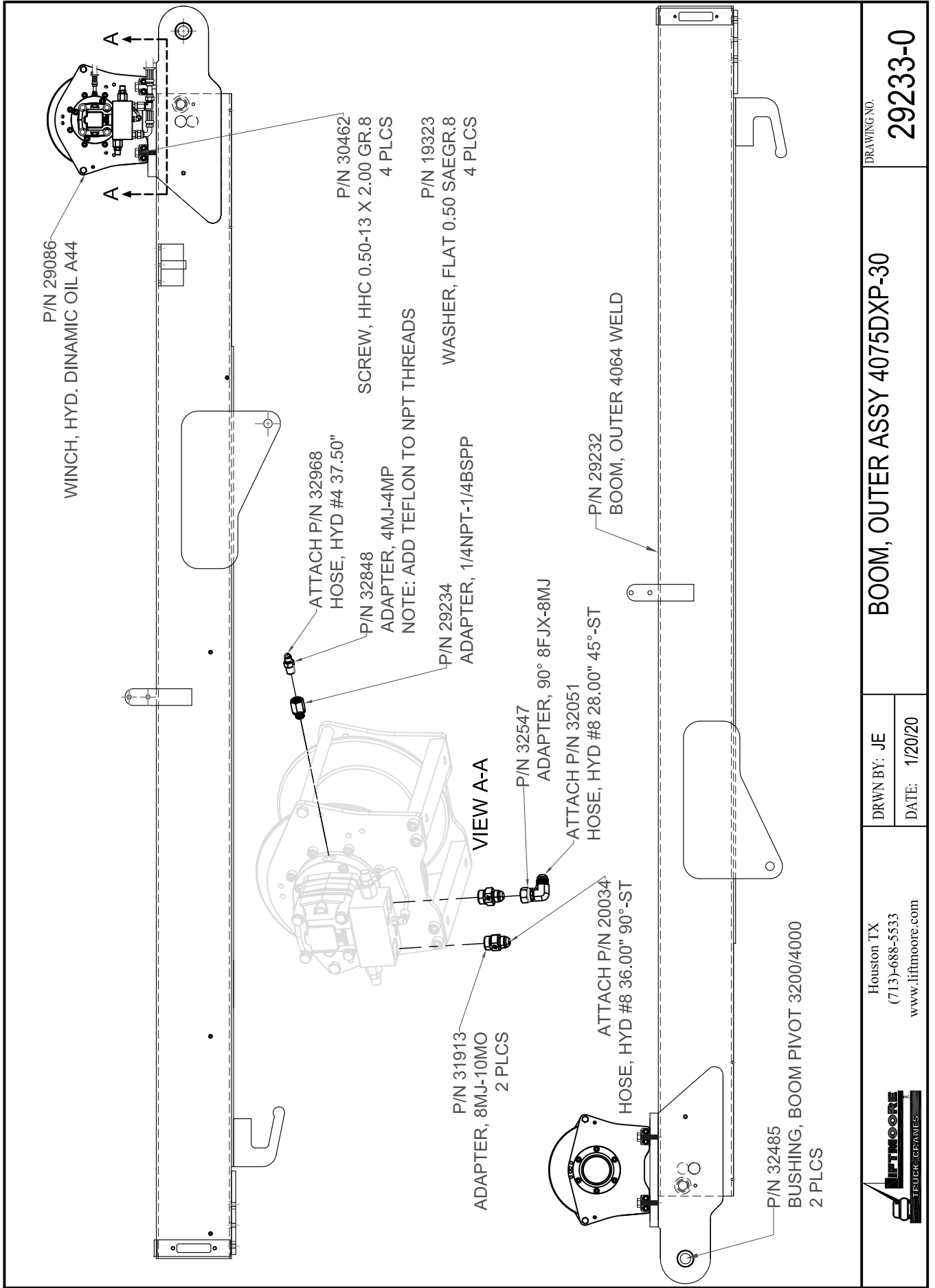

DRAWING NO.
29233-0

BOOM, OUTER ASSY 4075DXP-30

DRWN BY: JE
DATE: 1/20/20

Houston TX
(713)-688-5533
www.liftmoore.com



NOTE: ADD VIBRA TITE TO ALL PADS

FRONT VIEW

NOTE: MAKE SURE ALL SEAMS ARE GRIEDED BEFORE ASSEMBLY

TORQUE VALUES
 △ = 10 FT-LBS
 □ = 30 FT-LBS

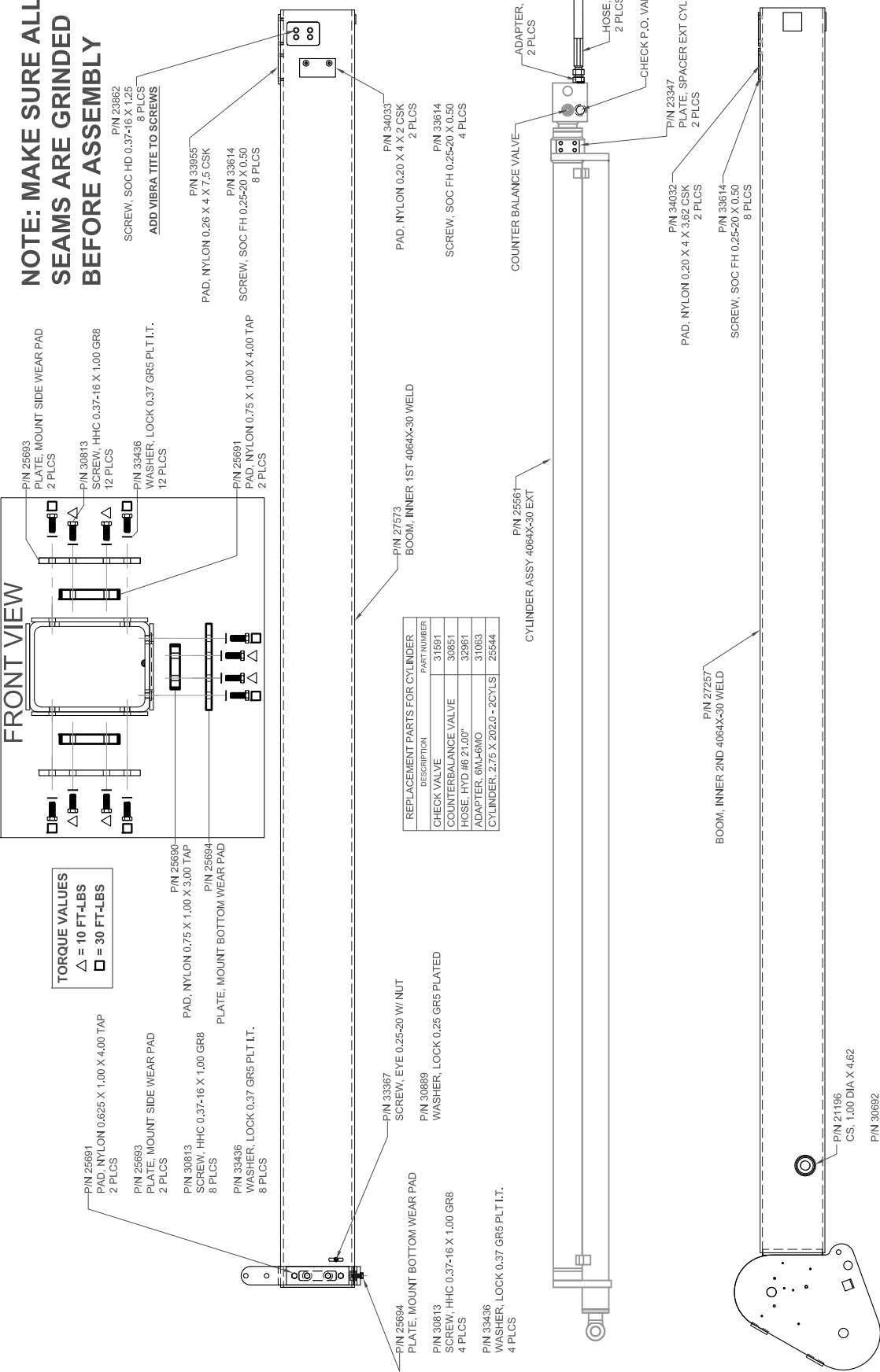

- PIN 25691
PAD, NYLON 0.625 X 1.00 X 4.00 TAP
2 PLCS
- PIN 25683
PLATE, MOUNT SIDE WEAR PAD
2 PLCS
- PIN 30813
SCREW, HHC 0.37-16 X 1.00 GR8
8 PLCS
- PIN 33436
WASHER, LOCK 0.37 GR5 PLT LT.
8 PLCS
- PIN 25690
PAD, NYLON 0.75 X 1.00 X 3.00 TAP
2 PLCS
- PIN 25694
PLATE, MOUNT BOTTOM WEAR PAD
8 PLCS
- PIN 33367
SCREW, EYE 0.25-20 W/ NUT
4 PLCS
- PIN 30889
WASHER, LOCK 0.25 GR5 PLATED
4 PLCS
- PIN 30813
SCREW, HHC 0.37-16 X 1.00 GR8
4 PLCS
- PIN 33436
WASHER, LOCK 0.37 GR5 PLT LT.
4 PLCS

- PIN 25683
PLATE, MOUNT SIDE WEAR PAD
2 PLCS
- PIN 30813
SCREW, HHC 0.37-16 X 1.00 GR8
12 PLCS
- PIN 33436
WASHER, LOCK 0.37 GR5 PLT LT.
12 PLCS
- PIN 25691
PAD, NYLON 0.75 X 1.00 X 4.00 TAP
2 PLCS
- PIN 33965
PAD, NYLON 0.26 X 4 X 7.5 CSK
8 PLCS
- PIN 33614
SCREW, SOC FH 0.25-20 X 0.50
8 PLCS
- PIN 34033
PAD, NYLON 0.20 X 4 X 2 CSK
2 PLCS
- PIN 33614
SCREW, SOC FH 0.25-20 X 0.50
4 PLCS

DESCRIPTION	PART NUMBER
CHECK VALVE	31591
COUNTERBALANCE VALVE	30851
HOSE, HYD #6 21.00"	32961
ADAPTER, 6MU-6MO	31063
CYLINDER, 2.75 X 202.0-2CYLS	25544

- PIN 27573
BOOM, INNER 1ST 4064X-30 WELD
- PIN 25561
CYLINDER ASSY 4064X-30 EXT

- COUNTER BALANCE VALVE
- ADAPTER, 6MU-6MO
2 PLCS
- HOSE, HYD #6 21.00"
2 PLCS
- CHECK P.O. VALVE
- PIN 23347
PLATE, SPACER EXT CYL 4064
2 PLCS
- PIN 34032
PAD, NYLON 0.20 X 4 X 3.62 CSK
2 PLCS
- PIN 33614
SCREW, SOC FH 0.25-20 X 0.50
8 PLCS

- PIN 27257
BOOM, INNER 2ND 4064X-30 WELD

- PIN 21196
CS, 1.00 DIA X 4.62
- PIN 30692
RING, SNAP 1" INTERNAL CS
2 PLCS

 Houston TX
 (713)-688-5533
 www.liftmoore.com

DRAWN BY: JEF
 DATE: 10/12/15

BOOM, INNER ASSY 4064/4075XP-30
 BAIL ATB, NEW WEAR PAD, WELDED CYL. SPACERS

DRAWING NO. 27575-F

THIS DRAWING INTENTIONALLY LEFT BLANK

FOR FUTURE ADDITIONS

OR

A PART OR FEATURE IS NOT APPLICABLE TO THIS CRANE



Houston TX
(713)-688-5533
www.iftmoore.com

DRWN BY:

DATE:

DRAWING NO.

THIS DRAWING INTENTIONALLY LEFT BLANK

FOR FUTURE ADDITIONS

OR

A PART OR FEATURE IS NOT APPLICABLE TO THIS CRANE



Houston TX
(713)-688-5533
www.iftmoore.com

DRWN BY:

DATE:

DRAWING NO.

THIS DRAWING INTENTIONALLY LEFT BLANK

FOR FUTURE ADDITIONS

OR

A PART OR FEATURE IS NOT APPLICABLE TO THIS CRANE



Houston TX
(713)-688-5533
www.iftmoore.com

DRWN BY:

DATE:

DRAWING NO.

CIRCUIT NUMBER AND DESCRIPTION		
Color	Length	Function
RED	23"	P12B.1 P2-R.1 ROT CW
RED/BLK	18"	P12B.2 P2-RA.1 ROT CCW
GRN	15"	P2-U.1 BOOM UP
ORN	18"	P12B.6 P2-LA.1 BOOM DWN
GRN/BLK	20"	P12B.3 P2-X.1 EXT OUT
ORN/BLK	25"	P12B.4 P2-XA.1 EXT IN
BLU	22"	P12B.7 P2-HA.1 HOIST UP
BLK	27"	P12B.8 P2-H.1 HOIST DWN
WHT/BLK	29"	P12B.9 P2-P.1 PROP
GRN	22"	P2-U.2 BOOM UP
WHT	15"	P12A.2 J5.C CAN HI
GRN	15"	P12A.3 J5.D CAN LOW
YEL/BLK	13"	P12A.5 P2-ATB.2 ATB
BLU/BLK	13"	P12A.6 P2-PS.2 PRESS SW
RED	16"	P12A.12 P6.2 PWR
RED	13"	P2-ATB.1 PWR, ATB
RED	13"	P6.4 P2-PS.1 PWR, PS
RED	15"	P6.5 J5.A PWR, CAN
YEL	N/A	P6.1 MAIN PWR FUSE HOLDER
N/A	N/A	P6.6 N/A PLUG
N/A	N/A	J5.E N/A PLUG
BLK	16"	P12A.11 BLU/FEM HORN 12V

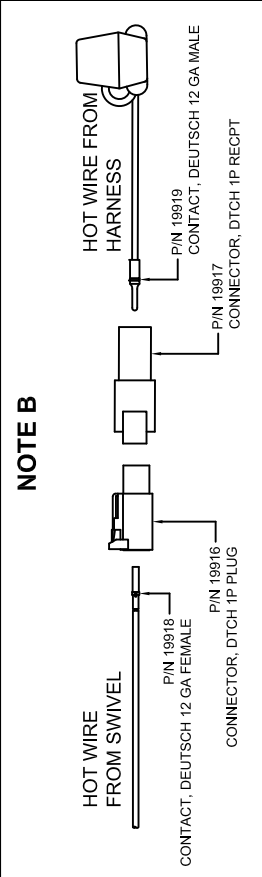
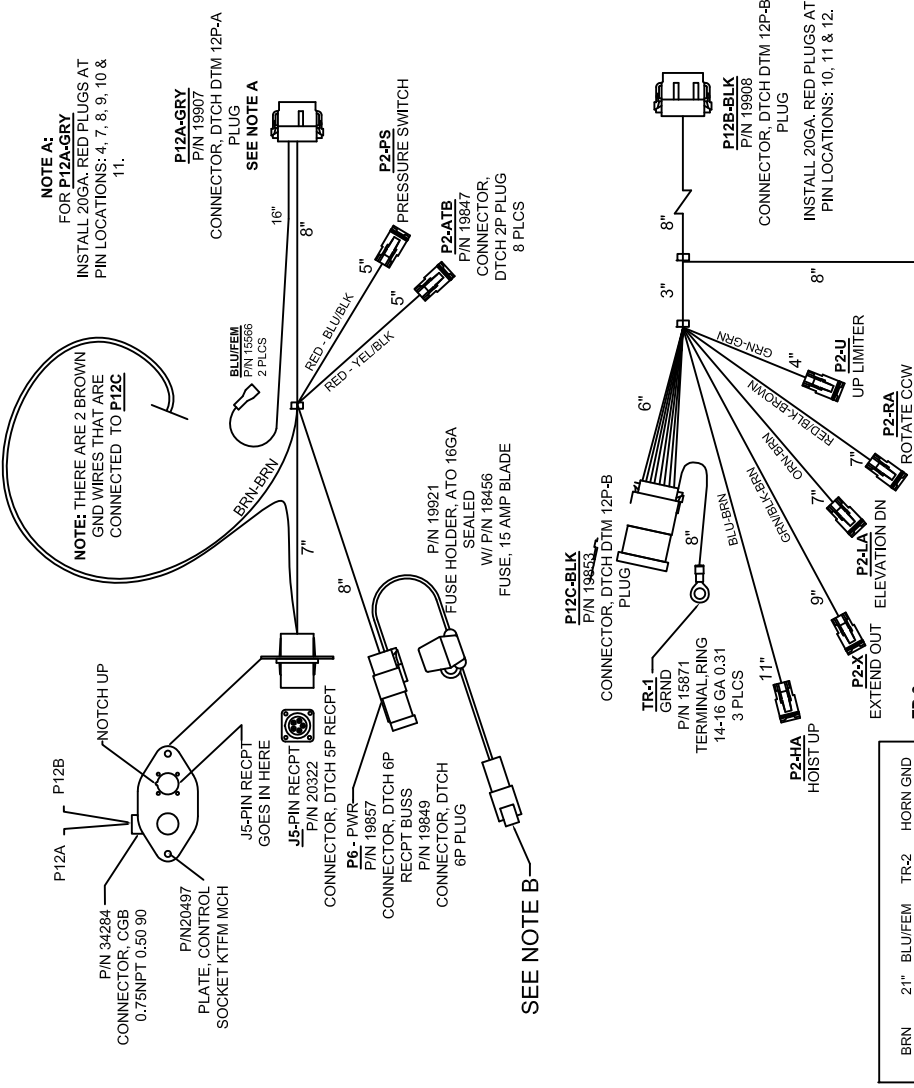

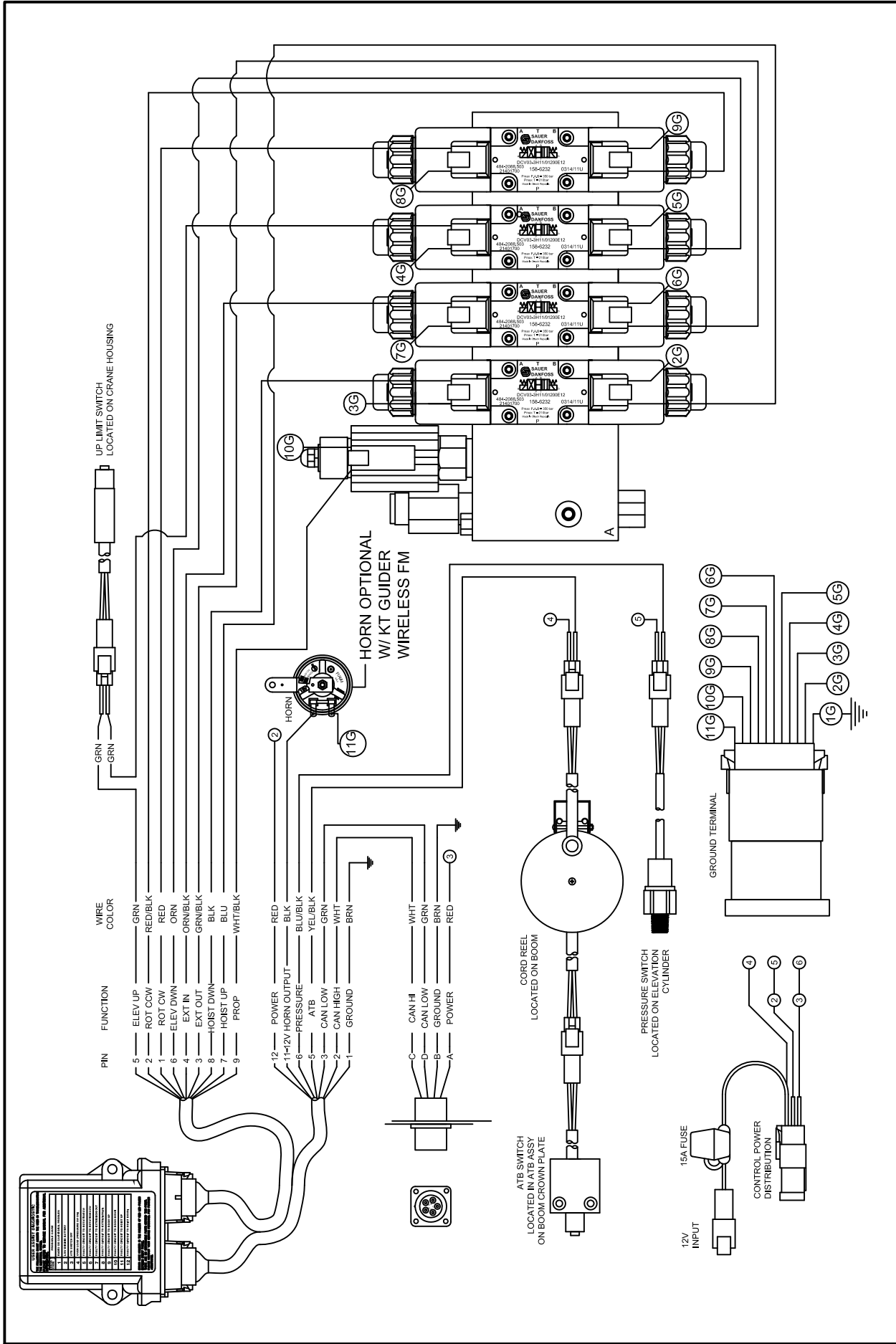

DRAWING NO. 50823-A

SCHEM, ELEC WIRING KTG XP
SAUER DANFOSS VALVES

DRWN BY: JE
DATE: 7/24/12

Houston TX
(713)-688-5533
www.liftmoore.com



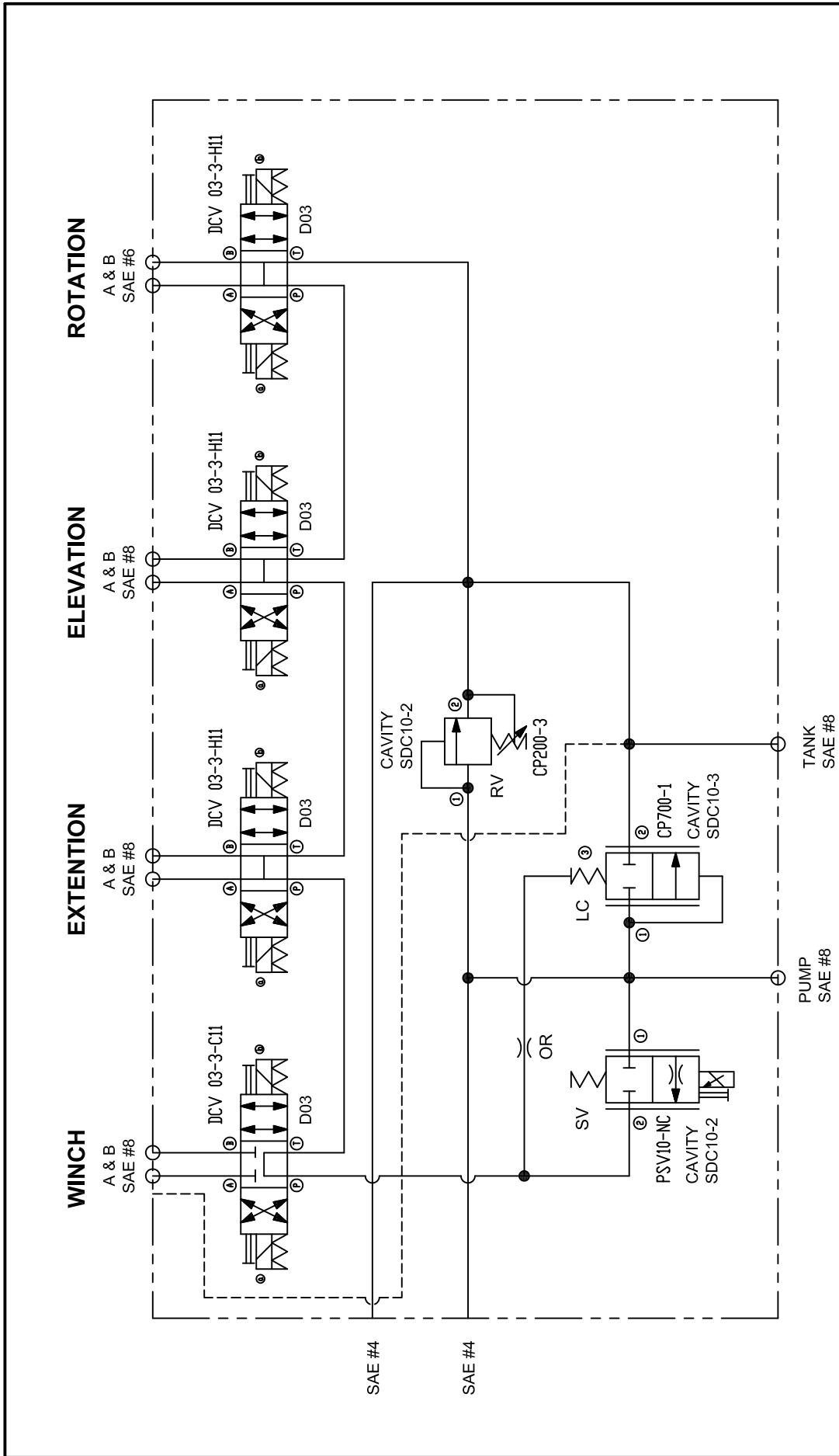

NOTE: HYDRAULIC SYSTEM RELIEF PRESSURE SET AT 2800 PSI.
 FLOW RATE INTO CRANE SHOULD BE SET AT 6-8 GPM.



Houston TX
 (713)-688-5533
 www.iftmoore.com

DRWN BY: JE
 DATE: 3/6/19

SCHEM, HYD PROPORTIONAL
 TANDEM CENTER WINCH, TANKLINE ON WINCH

DRAWING NO.
 50913-0

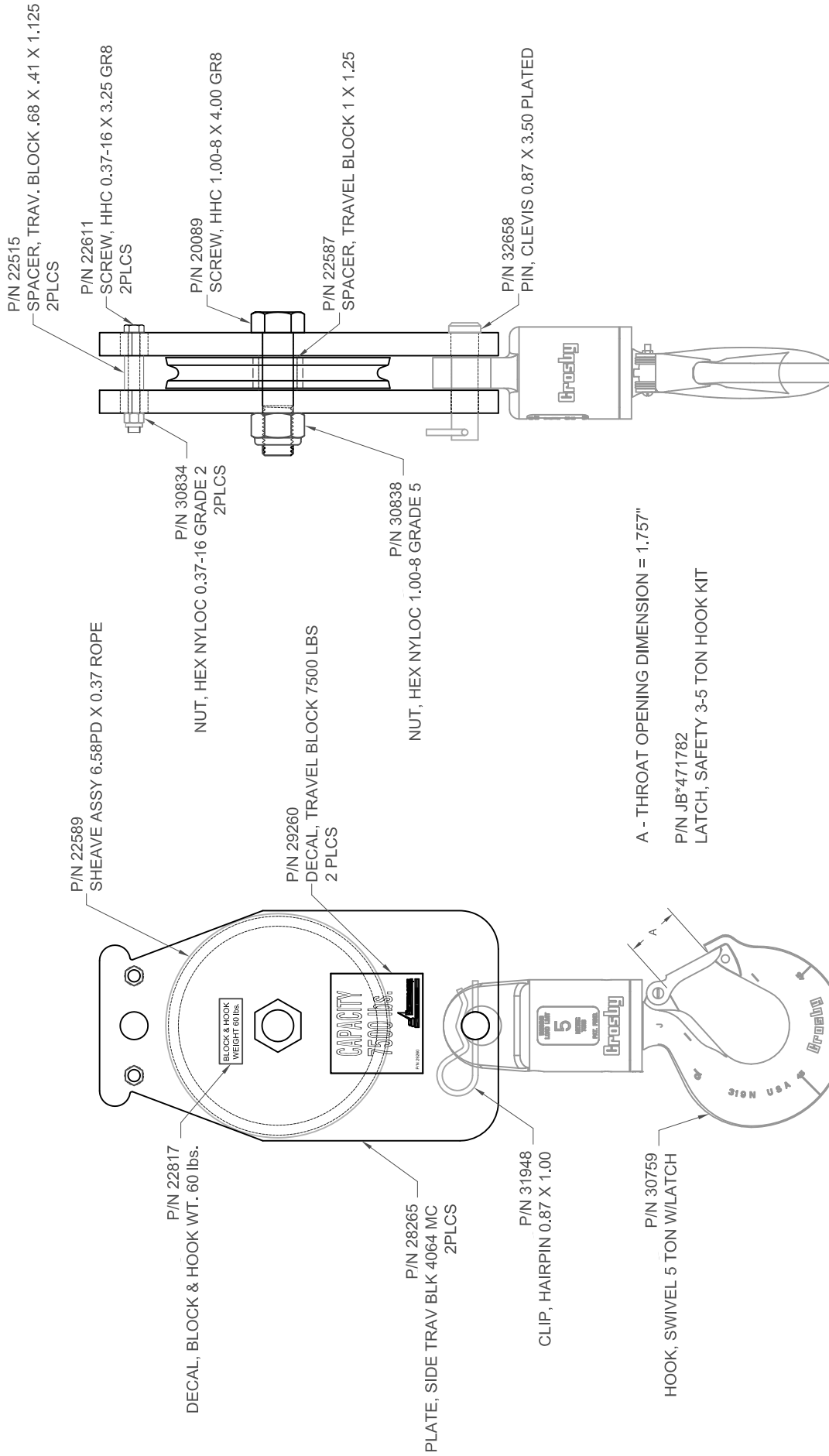

CAUTION:

NEVER USE A HOOK WHOSE THROAT OPENING HAS BEEN INCREASED, OR WHOSE TIP HAS BEEN BENT MORE THAN 10 DEGREES OUT OF PLANE FROM THE HOOK BODY, OR IS IN ANY WAY DISTORTED OR BENT.

DRAWING NO.
29259-0

BLOCK, TRAV ASSY 7.5K lbs/6.5D
6.58PD X 0.37 ROPE; 30759 HOOK

DRWN BY: JE
DATE: 1/23/20

Houston TX
(713)-688-5533
www.liftmoore.com



LIFTMOORE LIMITED WARRANTY

Parts and Structural

Liftmoore, Inc. warrants each LIFTMOORE crane to be free from defects in materials and workmanship for twelve (12) months from the date of delivery to the original customer. Under the terms of this warranty the crane structural components manufactured by LIFTMOORE, Inc. are warranted for thirty-six (36) months from the date of delivery to the original customer. LIFTMOORE, Inc. will repair or replace, as its sole discretion, any equipment or part that is returned f.o.b. to LIFTMOORE, Inc.'s plant at 7810 Pinemont Drive, Houston, Texas 77040, or to one of its authorized dealers, and is found by LIFTMOORE, Inc. or its authorized dealer to have been defective at the time of original delivery.

The foregoing warranty is the exclusive warranty made by LIFTMOORE, Inc. with respect to its cranes and is in lieu of all other warranties. ANY AND ALL OTHER WARRANTIES, EXPRESS OR IMPLIED, INCLUDING ANY WARRANTY OF MERCHANTABILITY OR FITNESS OF ANY CRANE FOR A PARTICULAR PURPOSE OR OPERATION, ARE HERBY EXPRESSLY DISCLAIMED.

The foregoing warranty applies only to LIFTMOORE cranes under normal use and service and does not apply in the event of damage caused by repair or alteration or damage during shipment, accident, negligence, overloading, or misuse, including operator's failure to follow any of the instructions issued with the crane.

This warranty is limited to the original purchaser and is not assignable. In order to submit a claim, the original purchaser must provide a copy of the original invoice for the crane in question within twelve (12) months following the delivery date and within 30 days from the date of repair.

The warranty applies only when the LIFTMOORE crane is used for commercial purposes and does not cover any purchase for use for personal, family or household purposes.

LIMITATION OF LIABILITY: LIFTMOORE, Inc.'s liability for any losses or damages resulting from any cause whatsoever, including LIFTMOORE, Inc.'s NEGLIGENCE or from a defective crane irrespective of whether such defects are discoverable or latent, shall in no event exceed the purchase price of the crane to which losses or damages are claimed, or at the election of LIFTMOORE, Inc., the repair or replacement of the defective crane.

In no event shall LIFTMOORE, Inc. be liable for any special, incidental, or consequential damages, including commercial losses or costs of any kind sustained by purchaser or any other person or for any damages for which purchaser may be liable to other persons by reason of any defect in any LIFTMOORE crane or any part thereof.

LIFTMOORE, Inc. reserves the right to make changes in design or construction of its cranes at any time without obligating itself to make such changes on cranes previously manufactured.

No agent, employee, or representative of LIFTMOORE, Inc. has authority to amend or modify the foregoing warranty or to bind LIFTMOORE, Inc. by any other warranty, guaranty, or assumption of liability.

In the event any provision of this warranty is for any reason held ineffective, the remaining provisions shall remain in full force and effect.

Some states do not allow limitations on how long an implied warranty lasts or the exclusion or limitation of incidental or consequential damages, so the above limitations and exclusions may not apply to you. This warranty gives you specific legal rights, and you may also have other legal rights that vary from state to state.

