

TABLE OF CONTENTS
 USERS MANUAL P/N 28948
 3200REE-12-20 PENDANT CONTROL
 20 FT BOOM
 E-STOP, GAUGE & LEVEL
 SAUER DANFOSS VALVE, ROTATION ADJUST

SECTION I
GENERAL OPERATION, INSPECTION, AND MAINTENANCE

CRANE SAFETY RULES	F1122-B.....	1-1
INTRODUCTION	F1111-D.....	1-3
OPERATING RESTRICTIONS	F1112-E.....	1-4
OPERATING PRACTICES.....	F1112-E.....	1-4
INSPECTION AND MAINTENANCE.....	F1113-D	1-7
MONTHLY INSPECTION REPORT	F1123-B.....	1-9
ANNUAL CRANE CERTIFICATION.....	F-1507-0.....	1-10
STANDARD HAND SIGNALS FOR CRANE OPERATIONS .	F2409-0.....	1-13

SECTION II
CRANE INSTALLATION INSTRUCTIONS

CRANE INSTALLATION INSTRUCTIONS	F917-K.....	1-17
MOUNTING PATTERN.....	50217-E	1-19
ELECTRICAL INSTALLATION	50377-E.....	1-20
STABILITY PROCEDURE.....	F691-G	1-21
STABILITY TEST RESULTS	F691-G	1-22

SECTION III
CRANE SYSTEMS AND TROUBLESHOOTING

ON/OFF PENDANT CONTROL SYSTEM.....	F1753-0.....	2-1
KTFM CONTROL SYSTEM(OPTIONAL).....	F1327-C	2-2
SAFETY SYSTEM.....	F1115-F	2-3
ELECTRIC HOIST.....	F1239-0	2-4
HYDRAULIC SYSTEM FOR ELECTRIC CRANE	F1145-D	2-5
TROUBLESHOOTING KHFM CONTROL SYSTEM.....	F1328-A	2-7
TROUBLESHOOTING SAFETY SYSTEM	F1254-A	2-8
TROUBLESHOOTING ELECTRIC HOIST	F1243-A	2-9
TROUBLESHOOTING HYDRAULIC PUMP.....	F1255-B	2-11
CONTROL TROUBLESHOOTING CHART.....	F1770-A.....	2-12
DEUTSCH CONNECTIONS & PINS.....	F2435-0.....	2-13

SECTION IV
CRANE SPECIFICATIONS

LIFTING CAPACITIES	F1315-E.....	3-1
POWER FUNCTIONS AND SPEEDS	F1315-E.....	3-1
BOLT AND LUBRICATION SPECS	F1315-E.....	3-2



TABLE OF CONTENTS
 USERS MANUAL P/N 28948
 3200REE-12-20 PENDANT CONTROL
 20 FT BOOM
 E-STOP, GAUGE & LEVEL
 SAUER DANFOSS VALVE, ROTATION ADJUST

**SECTION V
 PARTS**

BOX PARTS LIST	F2595-0	4-1
CRANE ASSEMBLY	DWG.28497-0	4-2
PENDANT CONTROL	DWG.23197-F	4-3
KTFM MEGA WIRELESS CONTROLS (OPTIONAL)	DWG.28490-B	4-4
RELAY BOX ASSEMBLY	DWG.22209-D	4-5
TRAVEL BLOCK ASSEMBLY	DWG.22556-C	4-6
ANTI-TWO BLOCK ASSEMBLY	DWG.22908-B	4-7
BOOM-BODY ASSEMBLY	DWG.28946-0	4-8
ELEVATION CYLINDER ASSEMBLY	DWG.21209-C	4-9
BODY ASSEMBLY	DWG.25951-C	4-10
MANIFOLD ASSEMBLY	DWG.22168-B	4-11
HYDRAULIC PUMP	DWG.29081-0	4-12
BASE-HOUSING ASSEMBLY	DWG.25908-E	4-13
ROTATION COMPONENTS	DWG.50706-A	4-14
ELECTRIC SWIVEL	DWG.50754-0	4-15
BOOM ASSEMBLY -12-20 FT	DWG.28942-0	4-16
BOOM INNER ASSEMBLY – 12-20 FT	DWG.28943-0	4-17
DECAL DIAGRAM	DWG.58346-D	4-18
WINCH	DWG.23872-C	4-19
WINCH COMPONENTS	DWG.23872-C	4-20
ELECTRICAL WIRING HARNESS	DWG.25046-E	4-21
ELECTRICAL SCHEMATIC	DWG.50793-C	4-22

WARRANTY	F1442-A
----------------	---------



CRANE SAFETY RULES

CAUTION!

1. READ AND UNDERSTAND OPERATOR'S MANUAL.
2. INSPECT VEHICLE AND CRANE, INCLUDING ITS OPERATION BEFORE DAILY USE.
3. USE THIS EQUIPMENT ONLY ON SOLID LEVEL GROUND WITH OUTRIGGERS OR JACKSTANDS PROPERLY SET.
4. BEFORE OPERATING THE CRANE REFER TO MAXIMUM LOAD CHART ON CRANE FOR OPERATING LOAD LIMITS.
5. BE SURE LOAD BEING LIFTED IS WITHIN SAFE WINCH CAPACITY AS WELL AS SAFE CRANE CAPACITY. MULTI-PART LINE OPERATION IS REQUIRED WHEN SINGLE LINE LOAD CAPACITY OF WINCH IS EXCEEDED.
6. DO NOT OPERATE, WALK, OR STAND UNDER THE BOOM OR ANY SUSPENDED LOAD.
7. ALWAYS PAY OUT LOAD LINE BEFORE EXTENDING BOOM. WIRE ROPE DAMAGE AND / OR BREAKAGE MAY OCCUR.
8. BOOM MUST BE IN ITS REST BEFORE MOVING VEHICLE.
9. BOOM TIP MUST BE DIRECTLY OVER THE LOAD BEFORE ANY LIFTING IS STARTED. DO NOT DRAG LOADS WITH THIS CRANE.
10. MAINTAIN THIS CRANE AS REQUIRED IN THE OWNER'S MANUAL.
11. DO NOT ALLOW PERSONNEL TO RIDE ON THE LOAD LINE, LOAD, OR BOOM OF THIS CRANE.
12. IT IS UNLAWFUL TO OPERATE THIS EQUIPMENT WITHIN TEN FEET OF HIGH VOLTAGE LINE



THIS PAGE INTENTIONALLY LEFT BLANK



F1122-B
05/12/08

HOUSTON, TEXAS
FAX: (800) 824-5559 (USA & Canada)
FAX: (713) 688-6324
PHONE: (713) 688-5533
www.liftmoore.com

INTRODUCTION

This crane is a powerful machine designed to lift and move heavy loads. There are many hazards associated with these operations. Liftmoore has designed this crane to be as safe as possible but -

IT IS THE OPERATOR'S RESPONSIBILITY TO PREVENT ACCIDENTS!

This takes pre-planning, attention, and knowledge of basic principles and rules. Even if you have used similar cranes, reading this manual in its entirety will help prevent damage, injury, or even loss of life; benefits well worth the short amount of time it takes to read these pages.

REGULATORY AUTHORITY

Use of this crane is governed by OSHA 29 CFR 1910.180 and may be governed by other federal, state, or local regulations.

IT IS THE OPERATOR'S RESPONSIBILITY TO UNDERSTAND AND COMPLY WITH ALL APPLICABLE REGULATIONS GOVERNING THE OPERATION, INSPECTION, AND MAINTENANCE OF THIS CRANE.

Personnel should be trained, tested, and certified, as recommended by OSHA and ANSI standards, before operating this crane.

USING THIS MANUAL

This manual assumes that the crane is mounted on a typical service body type or similar truck, which is powered by the vehicle electrical or hydraulic system, and is controlled by either the standard pendant control or FM radio control sold by Liftmoore, Inc.

This manual is supplied to provide basic guidelines for the safe use, routine maintenance, and general inspections of this crane.

This manual is supplied to provide basic guidelines for the safe use, routine maintenance, and general inspections of this crane.

Laws, regulations, standards, or policies may be more restrictive than this manual. If a conflict exists for any limit or condition, the safest or most prohibitive shall be used. Under no circumstances shall the load, moment, or stability ratings be exceeded.

Pay particular attention to the following:

WARNING! – Draws attention to hazards, conditions, or procedures that if not observed could result in injury or death.

CAUTION! – Draws attention to hazards, conditions, or procedures that if not observed could result in damage to the crane, load, or other equipment. Equipment failure could in turn lead to injury or death.

NOTE! – Draws attention to conditions or procedures that are essential to emphasize.

For questions, interpretations, or to report errors, please contact Liftmoore, Inc, Engineering Dept.



OPERATING PRACTICES

OPERATING RESTRICTIONS

DUTY CYCLE

For Electric Cranes the duty cycle time should be limited to 10%. This is limited by heat buildup in the motors and declining charge in the batteries. (Installing extra batteries near the crane helps keep the voltage at maximum.)

PERSONNEL

LIFTING OR MOVING OF PERSONNEL IS STRICTLY PROHIBITED! This crane was neither designed nor intended to lift personnel. Under no circumstances should anyone be allowed to ride on the crane, line, or load. All non-essential personnel must be kept away when using the crane. The load must never be moved over people, nor must anyone be allowed to pass or stand under a suspended load.

ELECTRICAL LINES

Consult ANSI B30.5 for operating procedures, minimum safe distances, and prohibited zones when working around electrical lines or poles.

When operating near electrical power lines, the crane must be positioned so that the distance from the crane to the lines or poles is equal to or greater than the length of the fully extended boom plus the minimum safe distance required.

All parts of the crane, line, and load must be kept a minimum safe distance from electrical power lines and poles. This distance is 10 feet for electrical lines carrying 50kV or less.

UNDER NO CIRCUMSTANCES SHOULD A CRANE BE OPERATED UNDER ELECTRICAL POWER LINES.

SETUP

POSITION The vehicle must be positioned so that the load is kept as close to the crane base as possible to reduce the moment on the crane. Consideration must be given to starting and ending position as well as firmness and slope of the ground and any obstructions.

OUTRIGGERS The outriggers or jackstands must be firmly set and the vehicle as level as possible. This will reduce the stresses on the rotation drive and keep the load off the vehicle's suspension. Keep in mind that the weight on the vehicle will shift as the crane and load is rotated.

MANUAL BOOM EXTENSION If the manual extension part of the boom is needed, it must be extended and the boom pin placed in the required position. Insert the pin and replace the pin's hairpin keeper before attempting to lift any load.

LOAD LIMIT The operator must understand the crane load chart. The operator must ensure that the load is within the load limits over the entire range which it will be moved. Be sure to include the weight of any lifting devices including the travel block.

The load limit chart is attached to the side of the crane to aid the operator.

The boom angle indicator and chart aids the operator in determining the load capacity at various boom angles and extensions. It also gives the load limit at that configuration.

STABILITY A stability chart must be posted near the crane. The operator must understand the stability chart. The crane may be de-rated over some areas of its operating radius.



TRAVEL BLOCK The operator must determine if the load is within the single line compatibility of the winch or if a multi-part line configuration is needed.

REEVING Ensure the proper routing of the rope through the sheaves and travel block. The rope must lie in the sheave groove and must not rub against any metal objects.

Ensure the rope is correctly wound on the winch drum. The crane assembly drawing will indicate if the rope must be wound over the top or bottom of the drum. The rope must never contact any part of the winch mounting.

WARNING!

If the winch winding direction is reversed the brake will not work and the load will fall.

ATTACHING THE LOAD

POSITION The boom tip must be moved over the load before lifting so that it will be lifted straight up.

CAUTION!

Never drag a load with the crane. Dragging a load puts very high stresses on the crane for which it was not designed.

ROPE Check the rope condition to ensure it is not frayed or damaged. Ensure that the rope is not kinked and that it does not contact any sharp edges or make any sharp bends.

If using double line configuration, ensure that the lines are not twisted.

CAUTION!

Never wrap the hoist rope around the load! Serious damage to the rope WILL occur.

HOOK Always make sure the load is applied to the throat of the hook. Never use a bent hook.

CAUTION!

Always lift with the throat of the hook. Never lift with the load applied to the tip of the hook. Doing so will bend the hook.

SLINGS If the load does not have a lifting eye, use a nylon, chain, or other type of sling designed for lifting and rated for loads greater than that being lifted.

BALANCE Ensure the load will be secure and balanced when lifted. Ensure that the load cannot shift in the sling and that the sling cannot slide across the hook should the load become unbalanced.

LIFTING THE LOAD

Before lifting, ensure that the load is free from all mountings and is no way attached or stuck to anything.

Ensure that at least five full wraps remain on the winch drum at all times.

Test the winch brake by lifting the load a few inches and ensuring that it does not slip.



HOLDING THE LOAD

The operator must keep the load in sight at all times once it is lifted.

The operator must never leave the controls once the load is lifted.

The operator must ensure that no one is allowed to pass or stand under a suspended load.

CAUTION!

Never move the vehicle with a suspended load. Doing so will put dynamic loads on the crane for which it was not designed.

MOVING THE LOAD

Before moving the load, make sure the path is free of any obstructions or people.

Avoid sudden accelerations or stops. Speeds must be kept to a minimum, especially rotation, to keep the load from swinging.

Avoid sudden reversing of direction. Do not reverse direction while the load is still moving.

Make sure that no part of the crane, boom, or load makes contact with any obstruction or comes within a minimum of ten feet from any electrical line.

TRANSIT

While in transit, the crane must be stowed, preferably in a boom rest. The crane must be prevented from rotating and the hook prevented from swinging.



INSPECTION AND MAINTENANCE

OSHA and ANSI require frequent and periodic inspections. Records of these inspections must be kept readily available. Liftmoore requires periodic maintenance to ensure proper operation and prolonged life of the crane.

INSPECTION

DAILY INSPECTION

OSHA 29CFR 1910.180 (d)(2)(i) requires the following be checked daily prior to use:

- All control mechanisms for maladjustment interfering with proper operation as well as for excessive wear of components and contamination by lubricants or other foreign matter.
- All safety devices for malfunction. This should include the anti-two block and pressure switch.
- Deterioration or leakage in air or hydraulic systems.
- Crane hooks with deformations or cracks. For hooks with cracks or having more than 15 percent in excess of normal throat opening or more than 10 deg. twist from the plane of the unbent hook.
- Electrical apparatus for malfunctioning, signs of excessive deterioration, dirt, and moisture accumulation. This should include the battery terminals, master disconnect switch, electrical swivel
- The wire rope shall be replaced if any of the following conditions are noted:
 - Kinking, crushing, bird-caging, or other damage
 - Reductions from nominal diameter of more than one-sixty-fourth inch for diameters up to and including five-sixteenths inch, one-thirty-second inch for diameters three-eighths inch to and including one-half inch.
 - Thimble is not in place or is damaged
 - Any evidence of heat damage
 - Six or more randomly distributed broken wires in 1 lay
 - Three or more broken wires in 1 strand in 1 lay

MONTHLY INSPECTION

A thorough inspection of all ropes in use shall be made at least once a month and a certification record which includes the date of inspection, the signature of the person who performed the inspection and an identifier for the ropes shall be prepared and kept on file where readily available. All inspections shall be performed by an appointed or authorized person. Any deterioration, resulting in appreciable loss of original strength shall be carefully observed and determination made as to whether further use of the rope would constitute a safety hazard. Some of the conditions that could result in an appreciable loss of strength are the following:

- Reduction of rope diameter below nominal diameter due to loss of core support, internal or external corrosion, or wear of outside wires.
- A number of broken outside wires and the degree of distribution of concentration of such broken wires.



- Worn outside wires.
- Corroded or broken wires at end connections.
- Corroded, cracked, bent, worn, or improperly applied end connections.
- Severe kinking, crushing, cutting, or unstranding.

PERIODIC INSPECTION

An Annual Inspection Form is included in this manual. OSHA 29CFR 1910.180 (d)(2)ii) requires periodic inspections of this crane. Liftmoore recommends an annual inspection using the included form.

MAINTENANCE PRECAUTIONS

The crane should be maintained monthly for safety reasons and to reduce stress on the crane.

WARNING!

Never perform any maintenance while the crane has any type of load on it. Use the manual operation procedure to lower the load if necessary.

WARNING!

Hydraulic cylinders may have high pressure stored in them even after hydraulic power is removed.

The counterbalance and pilot operated check valve in the cylinder will always hold some pressure in the cylinder. Slightly extending the cylinder then retracting a small amount will relieve most of the pressure in the cylinder. **DO NOT DEADHEAD THE CYLINDER!** This will store the maximum amount of pressure in the cylinder. Care should be taken when either valve is removed from the cylinder as some pressure will still remain.

After any maintenance has been performed the crane shall not be operated until all guards have been reinstalled, all safety

devices reactivated, and maintenance equipment removed.

LUBRICATION Refer to the crane specification section for the periodic maintenance schedule and type of lubrication required.

BOLTS Bolts may loosen over time due to vibration; therefore they should be checked periodically. If bolts need to be replaced, make sure they are replaced with bolts of equal or greater strength. Check the periodic maintenance schedule (Crane Specification Section) for bolt specification and torque.

NOTE!

Sheave and boom and cylinder pivot bolts are not standard bolts. The shank and thread length of these bolts have been modified so that they do not pivot on the threads. Consult the parts section of this manual for part numbers of these bolts.

OTHER MAINTENANCE

Refer to parts drawings for any specific maintenance or adjustment procedures such as hydraulic winch brake, rotation drive gear set adjustment, Ect.



MONTHLY INSPECTION REPORT

Crane Model No. _____ **Serial Number** _____

- Are Boom Hitch Pins and Keepers in place? Yes _____ No _____
- Wire Line Hook with Safety Latch Working? Yes _____ No _____
- Is Hook OK, (Not bent)? Yes _____ No _____
- Is Thimble on Wire Rope OK? Yes _____ No _____
- Is Traveling Block in use? Yes _____ No _____
- Is Wire Rope OK, not kinked or frayed? Yes _____ No _____
- Are all Boom Sections straight? Yes _____ No _____
- Are Sheave Bolts in place and tight? Yes _____ No _____
- Do all Sheaves rotate easily? Yes _____ No _____
- Are Mounting Bolts tight? Yes _____ No _____
- Is Anti Two-Block functioning properly? Yes _____ No _____
- Is Boom Angle Indicator in place and functioning and is Chart legible? Yes _____ No _____
- Are Cylinder Mounting Bolts secure? Yes _____ No _____
- Are Winch Mounting Bolts tight? Yes _____ No _____
- When stopped does winch drift less than 1.0 Inches? Yes _____ No _____
- Is Load Chart in place and easily read? Yes _____ No _____
- Are functions on Pendant operating correctly? Yes _____ No _____
- Is Hydraulic Reservoir full? Yes _____ No _____
- Is Outrigger straight and functioning? Yes _____ No _____
- Any items checked 'No' must be repaired before using this crane.



ANNUAL CRANE CERTIFICATION (29CFR1910.180)

OWNER _____

MODEL NUMBER _____ SERIAL NUMBER _____

DATE _____

Check the following:

___ Crane Mounting Bolts (Torque)

___ Winch mounting Bolts (Torque)

___ Boom mounting bolts

___ Cylinder mounting bolts

___ Cracks on boom (Check when extended)

___ Extension Pads not worn excessively

___ Cracks on housing

___ Weld cracks on boom

___ Weld cracks on housing

___ Boom swing approximately one inch or less at boom tip when retracted

___ Hydraulic leaks

___ Hoses not chafed or cracked

Sheaves not cracked

___ Boom Tip

___ Traveling Block

___ Sheaves not worn excessively

___ Boom Tip

___ Traveling Block

___ Sheaves rotate freely

___ Boom Tip

___ Traveling Block

___ *Load Chart in place and legible*

___ *Boom angle chart in place and legible*

___ *Labels in place (See manufacturer's chart)*

___ *Crane Hook Throat Opening within 15% of standard*

___ *Crane Hook not bent more than 10 degrees from plane*

___ *Hook safety latch operating properly*

___ *Booms pin(s) and Keeper(s) in place (Manual Extension Section)*

___ *Wire Rope removed if the following occurs:*

Six randomly distributed broken wires in one lay or three broken wires in one strand in one lay.

Wear of one-third the original diameter of outside individual wires.

Kinking, crushing, bird-caging or any other damage.

Evidence of heat damage.

Reduction from nominal diameter of more than one sixty-fourth inch for diameters to five-sixteenths diameter and one-thirty-second inch for diameters three-eighths to one-half inch.

___ *Wire Line installed as manufacturer requires.*

___ *Protective covers in place*

___ *Grease crane as required*

Check fluid level

___ *Winch*

___ *Gearbox*

___ *Reservoir*

Control system for proper operation

___ *Winch Up and Down*

___ *Boom Up and Down*

___ *Boom In and Out*

___ *Rotation CW and CCW*

Anti Two-Block (Required on Power Extendible Cranes) interrupts:

___ *Boom Down*

___ *Boom Out*

___ *Winch Up*

___ *Boom Up stopped by Up Limit Switch*

___ *Outrigger or jackstand operable*

___ *Outrigger crushing decal in place*

___ *Outrigger and Jackstand operates properly*

___ *Boom rest in place and used*

___ *Load Sensor trips when overloaded*

___ *Winch Down does not overrun when stopped*

___ *Crane stability chart in place and visible.*

I certify that I have performed the above tests and that any deficiencies were corrected and now comply as above.

Signed _____



Print Name _____

Company _____



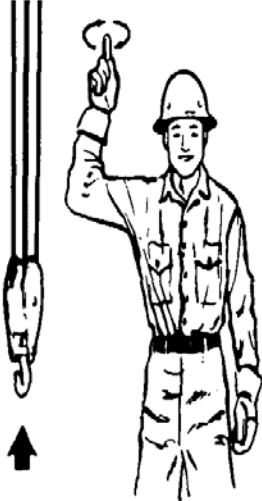
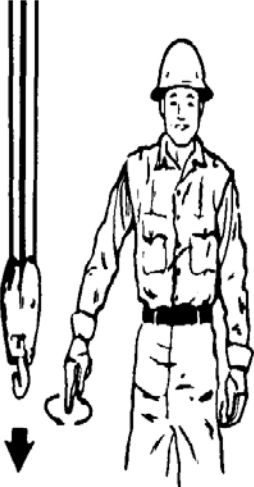

Address _____

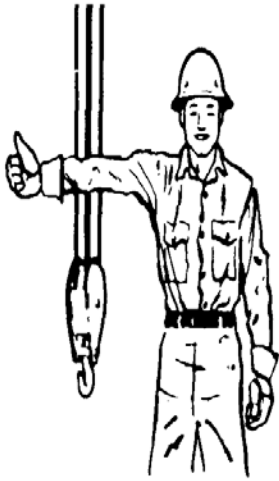
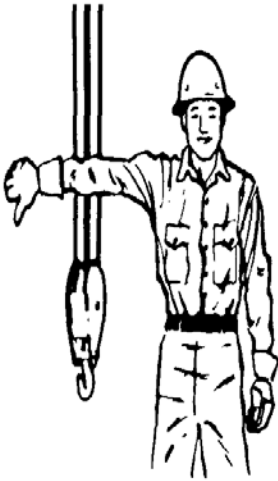
City _____ *State* _____

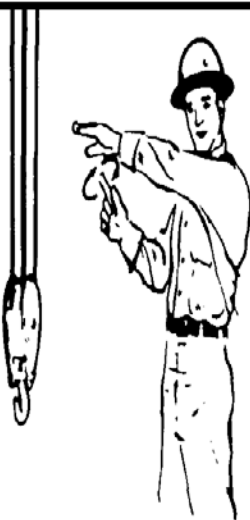
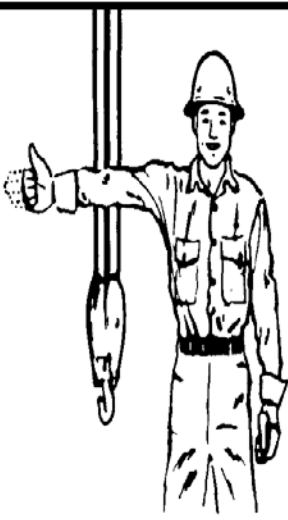
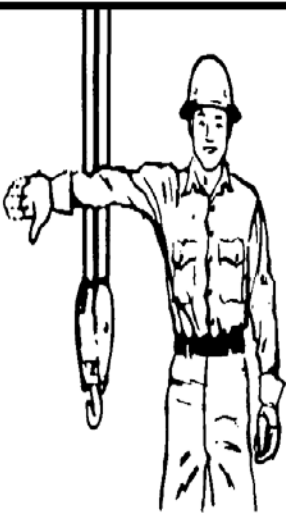
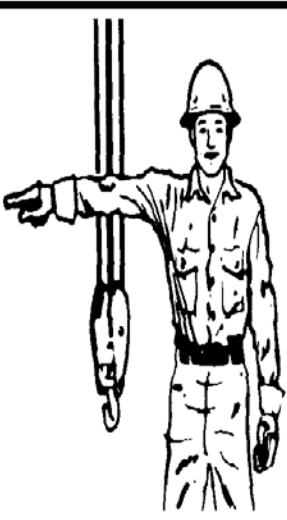
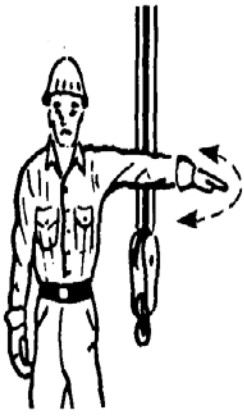
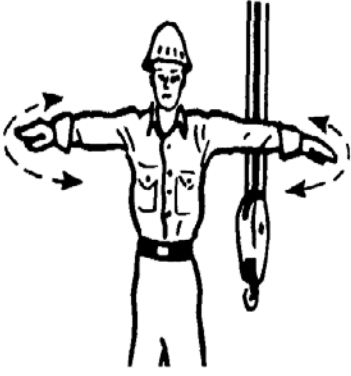
STANDARD HAND SIGNALS FOR CONTROLLING CRANE OPERATIONS

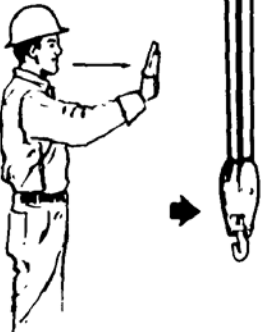
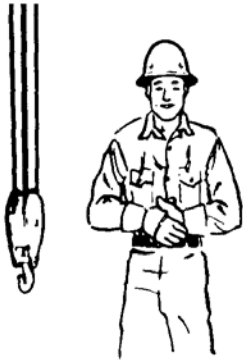
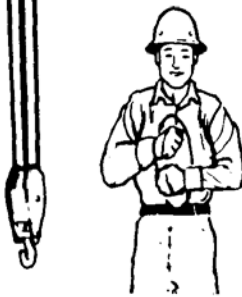
 <p>HOIST. With forearm vertical, forefinger pointing up, move hand in small horizontal circle.</p>	 <p>LOWER. With arm extended downward, forefinger pointing down, move hand in small horizontal circle.</p>	 <p>USE MAIN HOIST. Tap fist on head; then use regular signals.</p>
 <p>USE WHIPLINE (Auxiliary Hoist). Tap elbow with one hand; then use regular signals.</p>	 <p>RAISE BOOM. Arm extended, fingers closed, thumb pointing upward.</p>	 <p>LOWER BOOM. Arm extended, fingers closed, thumb pointing downward.</p>

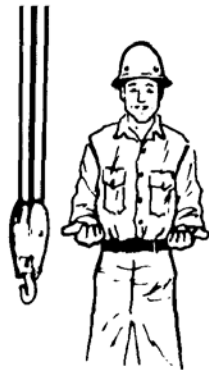
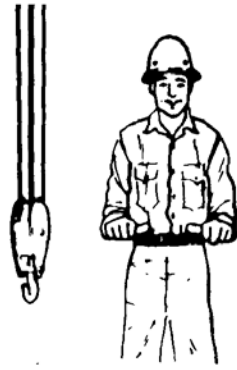
 <p>MOVE SLOWLY. Use one hand to give any motion signal and place other hand motionless in front of hand giving the motion signal. (Hoist slowly shown as example.)</p>	 <p>RAISE THE BOOM AND LOWER THE LOAD. With arm extended, thumb pointing up, flex fingers in and out as long as load movement is desired.</p>	 <p>LOWER THE BOOM AND RAISE THE LOAD. With arm extended, thumb pointing down, flex fingers in and out as long as load movement is desired.</p>
 <p>SWING. Arm extended, point with finger in direction of swing of boom.</p>	 <p>STOP. Arm extended, palm down, move arm back and forth horizontally.</p>	 <p>EMERGENCY STOP. Both arms extended, palms down, move arms back and forth horizontally.</p>

 <p>TRAVEL. Arm extended forward, hand open and slightly raised, make pushing motion in direction of travel.</p>	 <p>DOG EVERYTHING. Clasp hands in front of body.</p>	 <p>TRAVEL (Both Tracks). Use both fists in front of body, making a circular motion about each other, indicating direction of travel, forward or backward. (For land cranes only.)</p>
 <p>TRAVEL. (One Track) Lock the track on side indicated by raised fist. Travel opposite track in direction indicated by circular motion of other fist, rotated vertically in front of body. (For land cranes only.)</p>	 <p>EXTEND BOOM (Telescoping Booms). Both fists in front of body with thumbs pointing outward.</p>	 <p>RETRACT BOOM (Telescoping Booms). Both fists in front of body with thumbs pointing toward each other.</p>
 <p>EXTEND BOOM (Telescoping Boom). One Hand Signal. One fist in front of chest with thumb tapping chest.</p>		 <p>RETRACT BOOM (Telescoping Boom). One Hand Signal. One fist in front of chest, thumb pointing outward and heel of fist tapping chest.</p>

THIS PAGE INTENTIONALLY LEFT BLANK



HOUSTON, TEXAS
FAX: (800) 824-5559 (USA & Canada)
FAX: (713) 688-6324
PHONE: (713) 688-5533
www.liftmoore.com

MODEL 2010, 2700, 3200, 3612, LA10K INSTALLATION INSTRUCTIONS

Read and understand this complete section before starting the crane installation.

Before installing make sure you have all necessary parts. Please refer to the Owner's manual Section 4-1 for the list of parts required for installation. Report any shortages to Liftmoore, Inc. immediately.

1. The mounting must be adequate to support the load and moment rating for the crane as listed:
 - 2010 - 2,000 Lbs. Maximum Load; 10,000 Ft.-Lbs. Moment Rating
 - 2700 - 2,700 Lbs. Maximum Load; 8,100 Ft.-Lbs. Moment Rating
 - 3200 - 3,200 Lbs. Maximum Load; 10,000 Ft.-Lbs. Moment Rating
 - 3612 - 3,600 Lbs. Maximum Load; 12,000 Ft.-Lbs. Moment Rating
 - LA10K - 2,000 Lbs. Maximum Load; 10,000 Ft.-Lbs. Moment Rating
 - 3200-12-20 - 2,874 Lbs. Maximum Load; 10,000 Ft.-Lbs. Moment Rating

For truck mounting the crane must be mounted on a structure that will carry the loads to both sides of the truck frame. Sample mounting instructions are available from Liftmoore upon request.

2. Layout the mounting holes for the crane as shown in the drawing No. 50217 in this manual. The base plate for this crane is 15" square with holes for four 1/2" bolts on a 12" square pattern. Drill four 9/16" mounting holes to match the 12" square pattern. Cut a 5.0" hole in the center of the mounting to clear the portion of the quill that projects through the base plate. On cranes with auxiliary controls in the pendant, the rotation is restricted. For these models, locate the rotation stop opposite the point where the boom will be restricted. Bolt the crane onto the truck using the 1/2" x 2-3/4" Grade 8 bolts supplied. If longer bolts are required, at least Grade 8 quality is needed. Tighten the 1/2" Grade 8 bolts to 120 Ft.-Lbs. Other bolts can be used if they are at least Grade 8 strength and no less than 1/2" diameter.

NOTE: Replace the plug in the reservoir with the filler-breather plug shipped with the box of crane parts.

3. A manual disconnect switch with mounting bracket and terminals is provided with the crane. This switch will act as the main power disconnect for the crane. Removing power from the crane during periods of non-use will help to increase the life of the crane's electrical components. The switch should be mounted as near as possible to the crane and in a position which will facilitate its use. Determine the appropriate mounting position for the switch and use the supplied terminals to splice in to the crane's main power cable. We recommend that this be below the welding connector supplied with the crane. Drawing No. 50377 illustrates where we recommend installing the disconnect switch, welding connector and circuit breaker. (Always turn off power when crane is not in use.)

4. The vehicle's battery should have a capacity of at least 90 Amp-Hr. A second battery located near the crane is strongly advised. This will keep the voltage as near 12 Volts as possible while the crane is running. The life of the crane's electrical components will be longer if the voltage is as near 12 volts as possible. A deep cycle battery provides the best battery life. Connect the second battery in parallel with the truck's original equipment battery using at least No. 1 battery wire.

5. Install the 150 Amp circuit breaker near the battery supplying the crane and on the battery's positive line with a universal or marine type wing nut lug terminal. This breaker is to protect the battery in event of an accidental grounding of the positive wire anywhere along its length. Use a section of the wire and the terminals supplied to connect between the battery and the circuit breaker. See drawing No. 50377.

6. Run the No. 1 battery cable along the inside of the chassis frame to the circuit breaker if a second battery is not used. Make sure that the cable is protected avoiding sharp edges and



**MODEL 2010, 2700, 3200, 3612, LA10K INSTALLATION INSTRUCTIONS,
Cont.**

heat sources such as the muffler or catalytic converter. Use loom for protection whenever the cable passes through the body, frame or other metal objects. The quick disconnect under the crane

should be accessible. Always leave this disconnected to take the crane out of the electrical circuit when it is not in use.

7. Install the extra ground wire supplied from the negative battery terminal to the truck's main frame. Grounding the battery to the frame protects the chassis wiring. Leave the regular ground to the engine as is. The battery end of both wires can be clamped together using a universal type battery connector. This ground must be in place to protect the truck's wiring and for efficient operation of the crane. A good ground must exist for the crane to work. Leaving this ground wire off can damage the truck's chassis wiring as it may then carry some of the crane circuits current. This wire must be as large as the battery lead wire for the system to operate efficiently.

8. A boom support must be installed to secure the boom when the truck is moved. Mount an eye on the boom rest for the hook as shown in Liftmoore's Accessories bulletin. The wire rope can then be used to secure the boom in the rest.

9. An outrigger must be installed to keep the truck and the crane as level as possible under all expected working conditions. Keeping the crane level reduces the loads on the rotation gear. This will also protect the truck's springs, axle and wheels when heavy loads are suspended from the crane. OSHA requirements require a stability test be performed on this installation. If the installation does not pass the stability test contact Liftmoore for information on derating the crane in the unstable areas.

10. Additional truck springs may be necessary depending upon the size of the truck and location of the crane on the truck. Add springs to bring the truck level after all equipment is mounted.

11. The crane is now ready to use. Read the Operating Instructions section of the Owner's Manual before operating the crane. When operating the crane for the first time run the cylinders through their full extension cycle to purge any air from the cylinder. Operate the crane to assure complete operation of all functions.

Operating speeds are approximately as follows:

Rotation of one revolution: 70 Seconds
Boom Elevation (75 Degrees): 35 Seconds
Boom Extension (6 Feet): 35 Seconds
Winch Line Speed: 17 Ft. per Min.

12. If equipped with an anti two-block device, verify that the anti two-block will stop extension out, boom down and winch up when the weight on the device is lifted by either function. Make sure that the weight is on the live or running wire rope. The Crane Assembly drawing in the owner's manual Section 4-2 illustrates how the weight should be installed on the line.

13. Place these Installation Instructions and the Owner's Manual with Operating Instructions in a convenient place for the user to find and use before operating the crane.

14. When complete, turn off the crane power switch and disconnect the welding connector.

15. Load Chart Decal is to be placed on the truck body for easy visibility by the user.



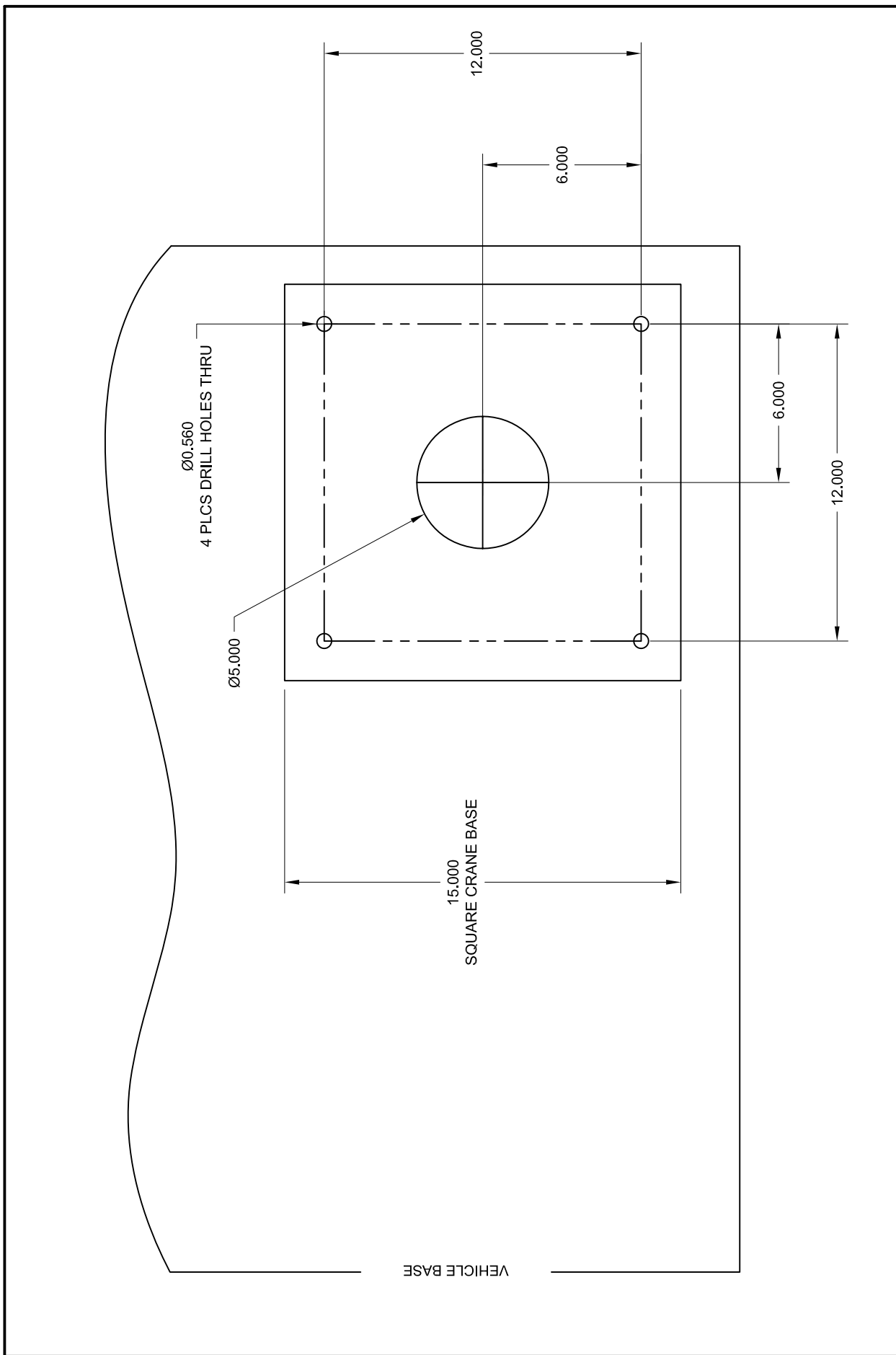

 Houston TX (713)-688-5533 www.liftmoore.com	DRWN BY: JC	DRAWING NO. 50217-E
	DATE: 9/10/08	

MOUNTING PATTERN FOR
1032/2000/2010/2700/3200/3612/LA10K

SUGGESTED WIRING SCHEMATIC FOR 208, 2000, 2700AR MODEL AND SMALLER CRANE
INSTALLATION:

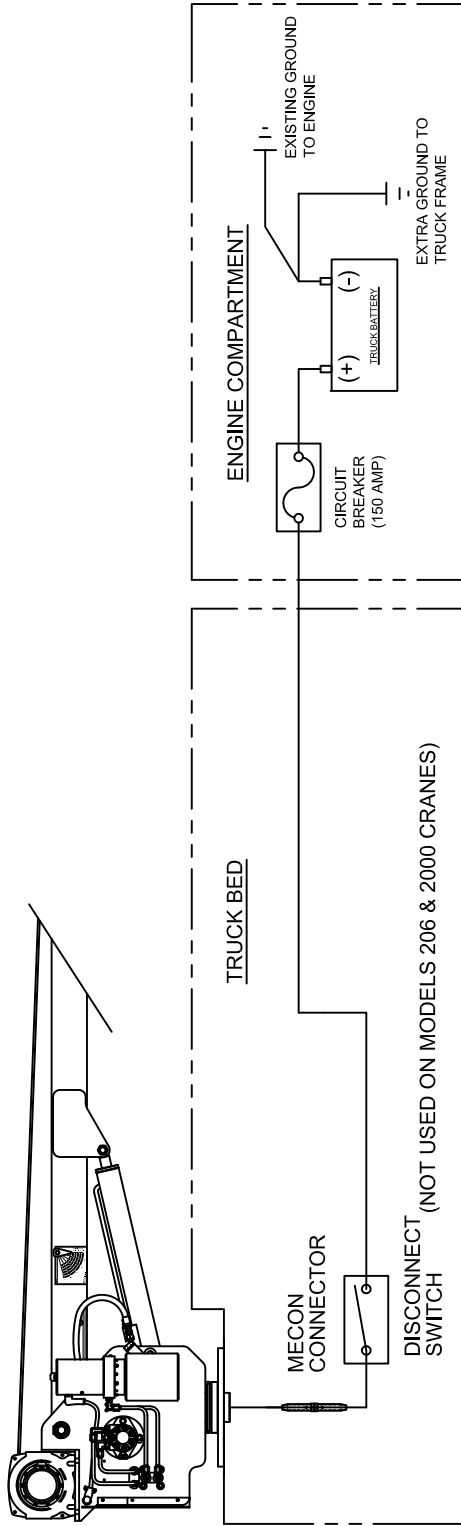

SUGGESTED WIRING SCHEMATIC FOR 3200 UP TO 4000 MODEL CRANE INSTALLATION:

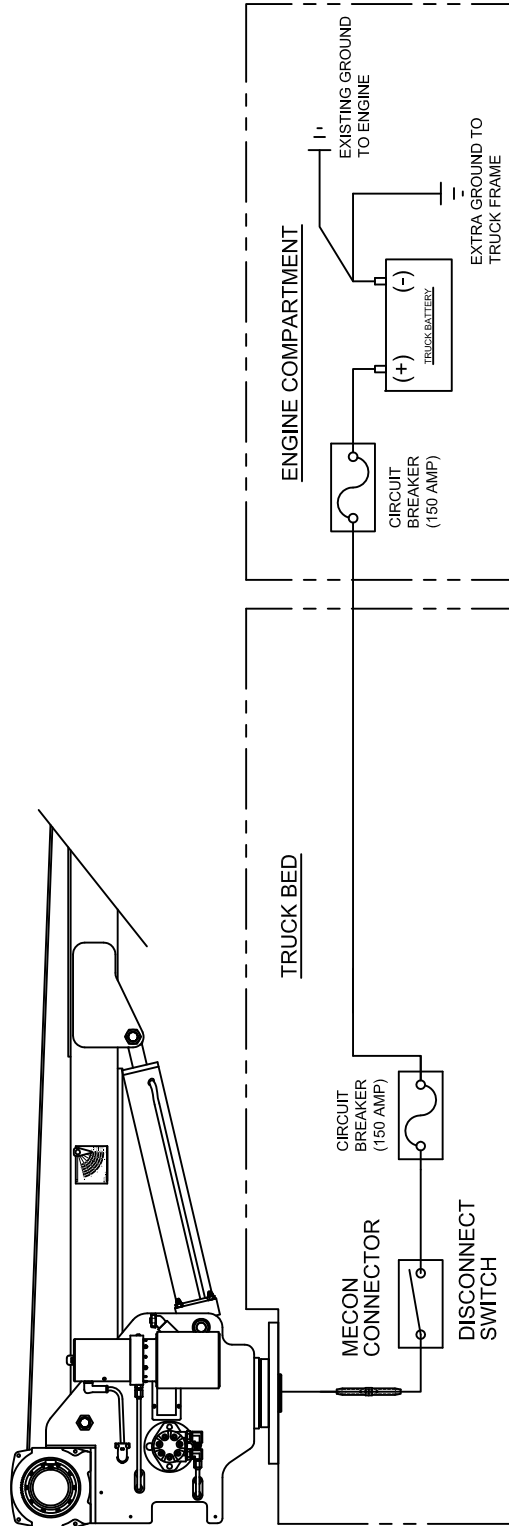

Houston TX
(713)-688-5533
www.liftmoore.com

DRWN BY: JC

DATE: 06/03/08

SCHEM, CRANE ELEC. INSTAL-ELEC
FOR 4000 & SMALLER ELECTRIC CRANES

DRAWING NO.

50377-F

VEHICLE STABILITY TEST

12/6/12

Liftmoore, Inc.
Form No. 691-G
Revised 1/30/2013

OSHA requires a stability test be completed by the installer. A qualified person shall perform this test. Please call Liftmoore for any assistance required in completing this test.

Test Preparations:

- Use as level of a test site as possible.
- Engage parking brake on vehicle.
- Set outriggers, jackstands, or other stability device in place.
 - Vehicle tires should remain in contact with the ground.
 - The vehicle should be level.

Fill out test form:

- Complete the vehicle and crane data at the top of Page 2 of this form.
- Use a known weight to determine the *Testing Load Radius*.

Test Procedure:

Determine Area W1 Length

1. With the crane extended to the *Testing Load Radius* over the rear of the truck, lift the load. Keep the load less than 4" off of the ground.
2. Rotate the load counterclockwise. Monitor all vehicle tires to ensure they remain in contact with the test surface.
3. When one of the vehicle's tires breaks contact with the ground, stop the rotation.
4. Use a protractor to determine this angle. Write this angle on the Stability Test Results as *Area Y*.
5. Keeping the load off of the ground, retract or elevate the boom until all tires are in contact with the test surface.
6. Continue rotating the load counterclockwise while monitoring all vehicle tires.
7. When one of the vehicle's tires breaks contact with the ground, stop the rotation.
8. Keeping the load off of the ground, retract or elevate the boom until all tires are in contact with the test surface.
9. Repeat this procedure until either the vehicle prevents further rotation or a 180 degree rotation of the load is reached.
10. Record the load radius in feet at this point on the Stability Test Results as *Area W1 Length*.

Determine Area W2 Length

11. Return the load to the rear of the vehicle and extend the load to the *Testing Load Radius*. Keep the load less than 4" off of the ground.
12. Rotate the load clockwise. Monitor all vehicle tires to ensure they remain in contact with the test surface.
13. When one of the vehicle's tires breaks contact with the ground, stop the rotation.
14. Use a protractor to determine this angle and write this angle on the Stability Test Results as *Area Z*.
15. Keeping the load off of the ground, retract or elevate the boom until all tires are in contact with the test surface.
16. Continue rotating the load clockwise while monitoring all vehicle tires.
17. When one of the vehicle's tires breaks contact with the ground, stop the rotation.
18. Keeping the load off of the ground, retract or elevate the boom until all tires are in contact with the test surface.
19. Repeat this procedure until either the vehicle prevents further rotation or a 180 degree rotation of the load is reached.
20. Record the load radius in feet at this point on the Stability Test Results as *Area W2 Length*.

Record Stability Test Results on Placard

21. Record the information from the Stability Test Results on the CRANE TRUCK STABILITY plate (P.N. 18600) and install the plate in a visible position on the vehicle, preferably near the crane.

THIS TEST IS NOW COMPLETE

STABILITY TEST FORM

Operational limits of this vehicle

VEHICLE INFORMATION	CRANE INFORMATION
Year _____	Model _____
Make _____	Serial Number _____
Model _____	Moment Rating (ft-lbs.) _____
VIN _____	

Determine The **Testing Load Radius** by using the following:

Moment Rating (ft-lbs.) _____
 Multiply by 1.18 x _____
 Divide by known weight ÷ _____
Testing Load Radius (ft.) = _____

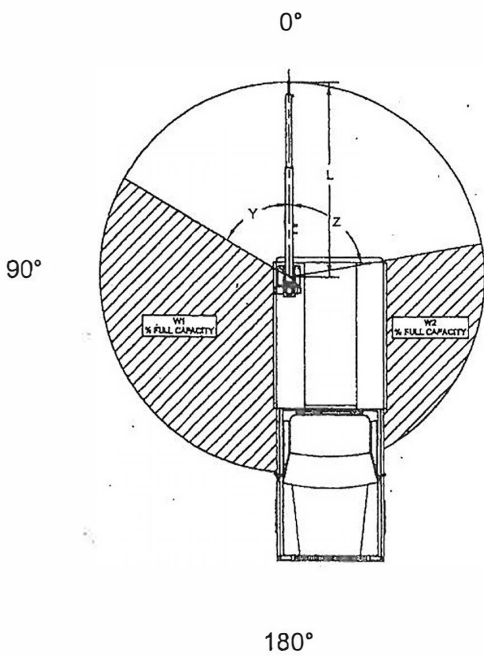

Area W1 Length _____
Testing Load Radius (ft.) ÷ _____
 Multiply by 100 x _____
 W1 % Rated Capacity = _____

Area W2 Length _____
Testing Load Radius (ft.) ÷ _____
 Multiply by 100 x _____
 W2 % Rated Capacity = _____

STABILITY TEST RESULTS	
Area Y:	_____ Degrees
Area Z:	_____ Degrees
Area W1 Rated Capacity:	_____ %
Area W2 Rated Capacity:	_____ %

Test performed by: _____

Date: _____

ON/OFF PENDANT CONTROL SYSTEM

Liftmoore cranes are electrically controlled using the hand-held pendant, which works in conjunction with the crane control module to operate powered functions.

PENDANT

All user inputs are facilitated by the remote pendant control. The pendant consists of pistol grip housing, wire, and control plug. The control plug mates with the crane control socket.

CRANE CONTROL MODULE

For ON/OFF (non-proportional) cranes the crane control module contains only the limiting system control board. It is a single printed circuit board enclosed in a rugged, sealed housing. Status LEDs are located on the circuit board to aid in troubleshooting.

The limiting system control is part of the safety system. Refer to that section for more information.

E-STOP

This feature is located on the pendant control box. The E-Stop button controls a relay in the crane's electrical power supply line. When pressed, electrical power is disconnected. To restore power you must turn button clock-wise until it pops back up

OPERATION

Plug the pendant into the crane control socket. Ensure all pins are straight and free of dirt, moisture, and corrosion. Turn the locking ring approximately 1/3 turn until it clicks into the locked position.

Select the function switch and direction as indicated on the label for the desired operation.

CARE AND MAINTENANCE

The pendant control is designed to be as rugged and maintenance free as possible; however, care should be used in handling and storage as it is expensive to replace.

Follow these simple practices:

- Keep the pendant out of the weather
- When not in use, store the pendant inside the vehicle or body compartment
- Do not wrap the wire too tightly as internal damage to the wires may result
- Do not place sharp or heavy object on the cord

NOTE!

The pendant is designed to be weatherproof not waterproof. It may be used in inclement weather, but if left outside or where water can puddle, water can seep inside.

Maintenance should be limited to routine inspection of the plug, wire, and fasteners.



KMFM CONTROL SYSTEM

KMFM – KAR-TECH MINI FM

The Liftmoore FM control system Model KMFM is a microprocessor-based radio remote control system, which allows wireless crane control. The receiver connects to the standard crane control socket, just like the wired pendant, so it is easily retrofitted and does not prevent use of the standard wired pendant.

RECEIVER

The receiver features encapsulated electronics for weather resistance and LEDs for user diagnostics. It is mounted to the crane and connects to the crane control socket. Upon user input, the receiver energizes the applicable function valves and/or solenoids, just as the wired pendant does.

TRANSMITTER

The transmitter is a pocket sized, hand held unit featuring an on/off power switch, push button switches for each function, and two diagnostics LEDs. It is powered by 2 AA Alkaline batteries and includes a power saving feature, which turns itself off if idle for 2 minutes

DIAGNOSTIC LEDs

There is a green and a red LED located inside the receiver and on the transmitter.

The green LED will blink every ½ second if there is communication between the transmitter and the receiver. It will blink every second if there is no communication.

The transmitter's red LED will blink once every second if the batteries are low and need to be replaced.

Error codes are indicated by a number of flashes of the red LED. For example, 4 blinks and a pause means output number 3 has a problem. See the trouble shooting section for more information.

MOUNTING

The FM receiver should be mounted so that it is protected from physical damage. It should be as high as possible with the antenna pointing upwards. A temporary mounting method, such as magnets or Velcro, is recommended so that it may be removed when not in use.

OPERATION

POWER ON- PRESS AND HOLD POWER BUTTON UNTIL GREEN LIGHT BEGINS FLASHING.

POWER OFF- PRESS AND HOLD POWER BUTTON UNTIL GREEN & RED LIGHTS STOP FLASHING.

REPLACEMENT OF COMPONENTS

Each transmitter is encoded with a digital ID that is programmed to its specific receiver. The receiver then only accepts signals from that transmitter so multiple cranes may be operated in the same vicinity without interference. If either component needs to be replaced, the receiver must be programmed to accept the new transmitter ID. Contact Liftmoore, Inc. for more information.

RETROFIT

The system design allows for easy retrofit. The only crane modification required is the simple addition of a ground wire to the control socket. This does not prevent the use of the wired pendant.



SAFETY SYSTEM

The safety system is designed to help prevent damage to the crane that would be caused by overload or two-blocking. The system consists of a load sensor, anti-two block device (optional on smaller, electric cranes), and limiting system control board.

When the applicable switch detects an overload or two-block condition, the limiting system will prevent activation of winch up, boom down, and extend out since these directions would cause damage. Winch down, boom up, extend in, and power rotation will still function so that the crane can be moved to a safe configuration.

CAUTION!

Never de-activate or override safety functions. Doing so can result in serious damage to the crane and possibly injury or death.

LOAD SENSOR

A pressure activated switch in the elevation cylinder acts as a load sensor. This switch is normally closed and opens at the preset pressure corresponding to the load rating of the crane.

CAUTION!

The load sensor will not function when the elevation cylinder is fully retracted and is inaccurate when the boom is below horizontal.

CAUTION!

The operator must never rely strictly on the load sensor to determine overload conditions. The load and load limits must always be known and adhered to.

ANTI-TWO BLOCK

The anti-two block device (optional on smaller electric cranes), mounted on the boom crown plate, consists of a normally open switch actuated by a lever. A weight is attached to the lever and holds the switch

closed. If the weight is lifted by the hook or travel block the switch opens.

The power and signal wires are wired through the cord reel, which is in turn wired to the ATB switch.

LIMITING SYSTEM CONTROL

The limiting system control prevents output of winch up, boom down and extend out if it is not receiving a signal from either the ATB or load sensor.

The ATB does not trip boom down when winch is mounted on the boom.

There is a one second delay before deactivation of boom down when the load sensor is tripped to prevent false readings caused by pressure spikes.

MISCELLANEOUS

UP LIMIT SWITCH

The up limit switch prevents the elevation cylinder from reaching full extension. If the elevation cylinder were to "dead-head", the resulting pressure would activate the load sensor, preventing boom down. The boom would then have to be lowered using the manual operation buttons on the solenoid valves.

CIRCUIT BREAKER, FUSE

For electric cranes a 150 Amp circuit breaker is supplied with the crane. It should be installed as close to the battery as possible. For hydraulic cranes a 10 Amp blade type fuse is supplied.

DISCONNECT SWITCH

A power disconnect switch is supplied with the crane. Power to the crane should be turned off whenever not in use. This is to prevent inadvertent or unauthorized use and will help prevent corrosion at electrical connections.



ELECTRIC HOIST

Permanent Magnet Motor

This Liftmoore crane features an electrically driven planetary gear hoist. The hoist is powered in both directions and features an automatic internal brake to positively control the load.

The hoist is permanently lubricated at the factory. Barring damage or part replacement, no further lubrication is necessary.

MOTOR

The hoist motor is a permanent magnet, reversible, direct current (DC) motor.

CAUTION!

The hoist motor is rated for intermittent duty. Duty cycle is limited to 5 minutes in 30 to allow the motor to cool. Extended use can damage the motor.

CAUTION!

When the motor approaches stall, a very rapid heat build up occurs which can cause permanent motor damage. Discontinue use when the motor speed is reduced excessively by voltage drop or load.

BRAKE

The hoist features a single acting, overrunning brake. It automatically activates to hold the load and assist in lowering the load.

WARNING!

The hoist brake only functions in one direction. If the hoisting direction is reversed by reversing the rope winding direction the brake will not hold and the load will fall. Serious injury or death could occur.

The brake is factory set and is not adjustable. If the brake fails to hold the load or if downward drift becomes excessive the brake must be replaced.

DIRECTIONAL CONTROL

Motor direction is controlled by either a solenoid pack or sealed contactor. Schematically, they are identical - two double pole-double throw solenoids are used to reverse polarity to the motor terminals.

Signal voltage, controlled by the pendant, energizes the selected directional solenoid, directing power to the winch terminal through the normally open terminal. The other terminal remains grounded through the normally closed terminal of the other solenoid.

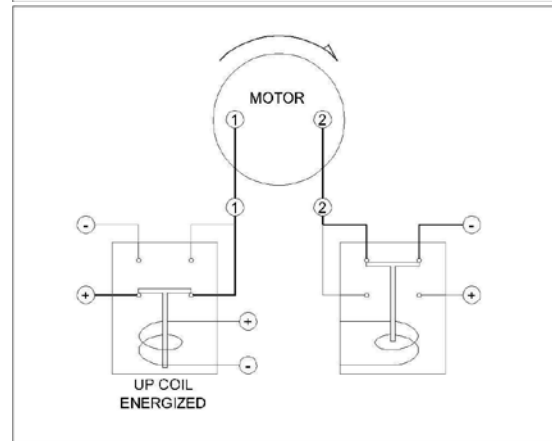
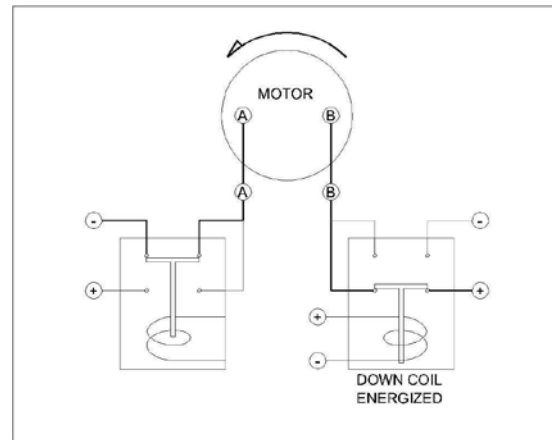

HYDRAULIC SYSTEM FOR ELECTRIC CRANES

The hydraulic system consists of the hydraulic pump, manifold, solenoid valves, cylinders, motors, and tubing and hoses. Hydraulic power is generated by the electrically driven hydraulic pump on the outside of the housing. The hydraulic system is plumbed in series so that more than one function can be operated simultaneously.

PUMP

The hydraulic pump assembly consists of a DC permanent magnet electric motor, pump, and reservoir.

The motor is activated by the pump solenoid. The solenoid is energized by the pendant control whenever a hydraulic function is activated.

The pump provides fluid pressure to power hydraulic functions. The system incorporates an adjustable relief valve to prevent damage that can be caused by over pressurizing the system.

Fluid is drawn from and returned to the reservoir. Servicing the hydraulic pump consist of maintaining the oil level. The reservoir should be kept as full as possible to prevent condensation from forming inside the tank. Also ensure the oil is not contaminated by water, dirt, rust, etc. See crane specification sheet for hydraulic oil type.

SOLENOID VALVES

Each hydraulically operated function is controlled by a 4-way, 3-position (open and close) center solenoid valve. It is electrically operated and spring biased to center. A manual operation button is incorporated in the coil-retaining nut. Valves are mounted to the series manifold.

CYLINDERS

Most hydraulic cylinders are double acting cylinders with integrally mounted counterbalance valve and pilot operated check valves. Refer to the cylinder drawings for specific information.

All cylinders use a counter-balance load holding cartridge valve on the extend port.

This valve performs 3 functions:

- Controls the rate of decent when lowering the load
- Keeps load from falling in the event of sudden loss of system pressure, such as when a hose bursts.
- Acts as a relief valve to prevent damage from induced load or thermal expansion.

It allows free flow to extend then blocks flow until opened by pilot pressure to the retract port or when the relief pressure is reached.

Some cylinders utilize a pilot operated check valve on the retract port to prevent the cylinder from creeping out under no load conditions. This valve allows flow into, but prevents flow from the retract port, thus hydraulically locking the cylinder until opened by pilot pressure to the extend port.

MOTORS

THE HYDRAULIC MOTOR USED BY THE ROTATION DRIVE IS A HIGH-TORQUE, LOW-SPEED CONSTANT DISPLACEMENT MOTOR. MANUAL OPERATION

If electrical problems occur the solenoid valves may be operated manually by depressing the manual operation button incorporated in the coil-retaining nut. Using a blunt object such as a bolt or screwdriver handle may be required to assist operation if high pressures are needed. Refer to the manifold drawing for function valves and directions.

If possible, activate the pump by activating a hydraulic function on the pendant. If this does not work, then energize the pump solenoid using a jumper from the hot side of



the solenoid to the coil post where the WHT/BLK wire is connected. If this fails also then battery voltage can be applied directly to the pump motor.

If hydraulic power is lost while a load is suspended, the load can be lowered by decreasing the setting on the counter-balance valve. This should only be done in extreme cases. The valve must be reset before the crane is returned to use.

WARNING!

The boom may fall if the adjustment is made too fast. Do not stand where the boom may hit you if it falls. Serious injury or death may result

WARNING!

The area between the boom and the cylinder, the boom and the housing, and the cylinder and the housing will change as the boom position changes and could form pinch points. Do not position any part of your body in these areas as it may be pinched or crushed as the boom lowers.

To decrease the setting, loosen the locknut on the valve, then slowly turn the adjustment stem **CLOCKWISE** until the load begins to lower. Count the number of turns so that the valve can be returned to its original setting.

Alternately, a pressure gage must be put on the retract port to adjust the setting so that approx. 1800 PSI is required to lower the boom with no load.

Test the setting by lifting a known load near the moment rating.

TROUBLESHOOTING KMFM CONTROL SYSTEM

If the crane does not operate, ensure that both the transmitter and receiver are on. Try disconnecting power to the crane receiver then reconnecting.

Run the crane using the wire pendant to confirm that the problem is the wireless unit.

Check that the green transmit light on the transmitter and the green receive light on the receiver light up when a function is selected.

Check for error codes and correct as necessary.

NOTE!

The green transmit light is located inside the transmitter.

Check that all connectors are secure.

Check for bent pins on the receiver connectors.

If the transmit and receive LEDs are both lit when a function is selected and no error codes are given contact Liftmoore, Inc. for further information.

Receiver Error Code Chart

	PROBLEM
1	RADIO SIGNAL PROBLEM
2	FAULTY CIRCUIT TO HOIST UP
3	FAULTY CIRCUIT TO HOIST DOWN
4	FAULTY CIRCUIT TO BOOM UP
5	FAULTY CIRCUIT TO BOOM DOWN
6	FAULTY CIRCUIT TO ROTATION CW
7	FAULTY CIRCUIT TO ROTATION CCW
8	FAULTY CIRCUIT TO EXTENSION OUT
9	FAULTY CIRCUIT TO EXTENSION IN
10	FAULTY CIRCUIT TO PUMP RELAY

ERROR CODE NUMBER IS THE NUMBER OF RED LIGHT BLINKS BETWEEN EVERY PAUSE

Transmitter Error Code Chart

	PROBLEM
1	LOW BATTERY
2	FAULTY CIRCUIT TO HOIST UP
3	FAULTY CIRCUIT TO HOIST DOWN
4	FAULTY CIRCUIT TO BOOM UP
5	FAULTY CIRCUIT TO BOOM DOWN
6	FAULTY CIRCUIT TO ROTATION CW
7	FAULTY CIRCUIT TO ROTATION CCW
8	FAULTY CIRCUIT TO EXTENSION OUT
9	FAULTY CIRCUIT TO EXTENSION IN
10	FAULTY CIRCUIT TO PUMP RELAY

ERROR CODE NUMBER IS THE NUMBER OF RED LIGHT BLINKS BETWEEN EVERY PAUSE.



TROUBLESHOOTING SAFETY SYSTEM

DTCH Relay Card

To check functions controlled by the safety system check the status indicators. (See Relay Box Assembly drawing.) If only one of the safety functions is not working, activate that function and check for error codes and/or its output status indicator.

For non-FM systems, if the status indicator lights then the problem is in the wiring or in the solenoid coil. If the light does not illuminate, check the control pendant. If the control pendant is good then the crane control module needs to be replaced.

For FM systems, check for error codes. If none are present, see the FM Troubleshooting section.

If boom out, boom down and winch up are not working, confirm that the control board has power. Confirm that the board is receiving a signal from the ATB and load sensor.

If the error code is active, ensure that the crane is not overloaded and that the ATB lever is holding the switch closed. Check for voltage at the ATB and Load Sensor inputs.

CHECK LOAD SENSOR SWITCH

If the load sensor input is not receiving voltage, locate the load sensor connector inside the crane housing. The plug side will have a red wire and a gray wire, the receptacle side will have a red and a white wire.

Disconnect and check for continuity between the two pins on the receptacle (switch side). If there is no continuity then the load sensor is bad and needs to be replaced.

CHECK ATB SWITCH

If the ATB input is not receiving voltage remove the ATB housing cover and disconnect the connector. Check for continuity on the switch side. Lifting the weight should break the continuity. If either of these conditions is incorrect the switch is bad and needs to be replaced.

CHECK CORD REEL

Check the ATB switch if not done so already. Locate the ATB connector inside the crane housing. The plug side will have a red wire and a black wire. The receptacle side will have a white wire and a black wire.

Disconnect the plug going to the switch. Check for continuity between the two pins on the receptacle. Have someone lift the weight on the ATB and continuity should be broken. If either of these conditions are incorrect then the cord reel is bad and needs to be replaced.

CHECK POWER TO SAFETY SWITCHES

If the safety switch is good, check for voltage at pin 1 (the red wire) on the plug. If there is no voltage, follow the wire back to the 6-pin power distribution plug, checking for breaks or shorts.

Remove the power distribution receptacle (cap).

NOTE!

Removing the cap will disconnect power to all electrical components. Be sure to replace the cap before continuing.

Check the cap for bent pins. Check that all wires are fully seated in the plug. If they are not, then remove the green locking wedge and push the wires forward until seated. Reinstall the wedge ensuring that no wires are pushed back.



TROUBLESHOOTING ELECTRIC HOIST

Permanent Magnet, Contactor Controlled

IMPORTANT NOTE!

The importance of first physically checking every connection between the battery and the crane cannot be overstressed!

Poor connections or poor grounding account for a large percentage of hoist problems. Time is often wasted chasing other probable causes only to eventually find a loose or corroded connection. **Measuring the voltage is not sufficient.** Often a poor connection will allow enough amperage to operate a meter or test light, but not enough to operate the hoist, which requires very high amperage.

If the problem is random and intermittent then it is almost assuredly a loose or bad connection.

Another common problem is low battery voltage. Even if the battery is good when troubleshooting begins, running the winch can quickly drain a battery. If it can be done safely, it is best to have the vehicle running.

Also check the control socket and plug for bent, corroded, or dirty pins.

CAUTION!

As the motor approaches stall, due to low voltage or excessive load, a very rapid heat build up occurs which will quickly damage the motor. If the motor is not turning, do not operate the switch for more than a second. Allow the motor to cool between attempts to make it run.

HOIST OPERATES IN ONLY ONE DIRECTION

If the hoist only operates in one direction swap the control wires on the contactor.

Activating the pendant switch in the working direction should now operate the hoist in the previous non-working direction.

Example: if hoist up is not working, after swapping the control wires activating the hoist down switch should cause the hoist to go up.

If it does then the hoist and contactor are working correctly and the problem is in the pendant crane socket or wiring. If it does not then the problem is the contactor or brake.

If the motor tries to turn but stalls then the problem is most likely the brake. Also, if the contactor makes a clicking noise then that is a good indication that it is working and, again, the problem is most likely the brake.

If the control wires were swapped in the previous step, return them to their original positions. Swap the motor wires (labeled 1 and 2). It is usually easiest to swap them at the motor.

Activating the pendant switch in the working direction should now operate the hoist in the previous non-working direction.

Example: if hoist up is not working, after swapping the motor wires activating the hoist down switch should cause the hoist to go up.

If it does, then one side of the contactor is not working and it needs to be replaced.

If it does not work, the problem is a brake malfunction. Inspect the brake installation. Correct any problems found. The brake cannot be repaired. Replace if any damage is found.



HOIST DOES NOT RUN IN EITHER DIRECTION

If the hoist does not run in either direction then the problem is either lack of power to the control socket or pendant, lack of sufficient power to the motor, or hoist brake malfunction or motor failure.

If the contactor clicks when the switch is activated then the control socket is getting power.

If all connections have not been checked, do so now. Also ensure that the battery still has sufficient power. As a rule of thumb, if it has enough power to start the engine, then it is good.

Activate the winch toggle switch and check for voltage at motor contacts. If positive voltage is measured at both terminals, the problem may be the ground wire from the contactor. Check for tightness or corrosion on this wire.

Once sufficient power is ensured, if there is any indication that the motor is trying to turn but stalls the problem is the brake – have it replaced.

If there is no indication that the motor is trying to turn and the contactor has been tested, then replace the motor.

TESTING THE PENDANT AND CONTROL WIRING

If the problem is narrowed to the control wiring, it is most likely caused by a cut or disconnected wire. A visual inspection of the

wiring should be made and repairs made as necessary.

Refer to the schematic and pendant drawing for pin functions and locations.

If no visual defects are found and if a continuity tester is available, disconnect the pendant and check for continuity between the control socket pin and terminal at the contactor.

Alternately, a piece of wire or metal object may be used to short between the control socket power pin and the socket hoist pin(s). If the hoist operates then the problem is in the pendant.

If not, check for power at the control socket power pin. If there is no power, trace the wiring back, checking each connection until the problem is found. Correct as necessary.



TROUBLESHOOTING HYDRAULIC PUMP

Electric Pump, 14P Socket

IMPORTANT NOTE!

The importance of first physically checking every connection between the battery and the crane cannot be overstressed!

Poor connections or poor grounding account for a large percentage of electrical problems. Time is often wasted chasing other probable causes only to eventually find a loose or corroded connection. **Measuring the voltage is not sufficient.** Often a poor connection will allow enough amperage to operate a meter or test light, but not enough to operate the motor, which requires very high amperage.

If the problem is random and intermittent then it is almost assuredly a loose or bad connection.

Another common problem is low battery voltage. Even if the battery is good when troubleshooting begins, running the motor can quickly drain a battery. If it can be done safely, it is best to have the vehicle running.

Also check the control socket and plug for bent, corroded, or dirty pins.

CAUTION!

As the motor approaches stall, due to low voltage or excessive load, a very

rapid heat build up occurs which will quickly damage the motor. If the motor is not turning, do not operate the switch for more than a second. Allow the motor to cool between attempts to make it run.

FOAMY FLUID

If the fluid foams then the problem is the pump seal – have it replaced.

PUMP DOES NOT RUN

If both the pump and winch are not working, the problem is power related or control wiring related. Troubleshoot those areas first.

If the solenoid is actuating it will make a clicking noise. If the solenoid is not clicking, check for power at the coil input (small screw terminal) on solenoid when the Boom Up switch is activated. If there is no power then the problem is the electrical wiring harness or pendant control wiring.(refer. to CONTROL TROUBLESHOOTING CHART).

If the coil is getting power when the switch is activated, but not clicking then the problem is most likely the solenoid.

If the solenoid is clicking check for full power input to the solenoid. Trace the wiring back to the crane input, checking for power at each connection until the problem is found. If full electrical power to the motor is confirmed then the motor is faulty and should be replaced.



CONTROL TROUBLESHOOTING CHART FOR "X" WIRED PENDANTS

No functions working	Not receiving power Make sure E-STOP button on pendant is released (not pressed)	Check crane control socket Pin E ensure that it is receiving 12V (Make sure E-stop is released) With the plug disconnected, activate a function switch then check continuity between Pin E and the activated function/direction pin For example: activate Hoist Down and check for continuity between Pin E and Pin P
One function not working	Faulty wiring/switch malfunction	With the plug disconnected, activate the function that is not working and check for continuity between Pin E and corresponding function pin
other	Check continuity on E-STOP button w/button released (not pressed)	Check Crane RELAY BOX for Error Codes and Proportional Output Voltage

FIGURE 1

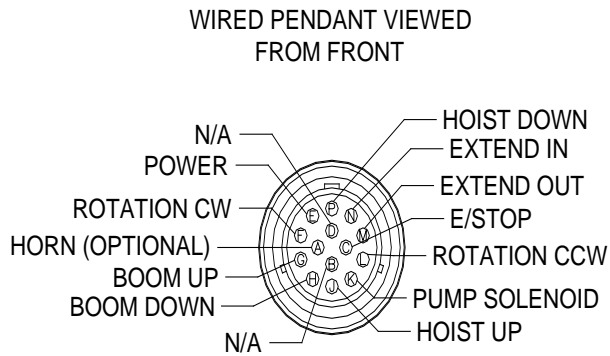

the error code LED a certain number of times with a pause at the end. It repeats the code until the problem is resolved. The **Error Code Chart** is provided to assist the service personnel in troubleshooting the system.

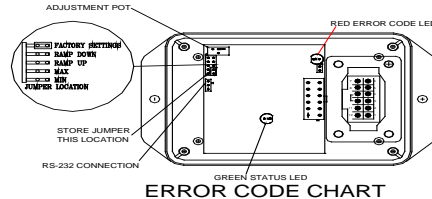

ERROR CODE CHART

ERROR CODE COUNT	PROBABLE CAUSE
1	No Input To ATB Switch Input
2	No Input To Pressure Switch Input Or Overload Condition
3	Short Or Overload To Winch Up Output
4	Short Or Overload To Elevation Down Output
5	Short Or Overload To Extension Out Output
6	Trigger Input Out Of Range

Figure 1 CONTROL PLUG ON PENDANT

Figure 2 RELAY BOX
SEE DWG



DEUTSCH CONNECTIONS & PINS



FEMALE'S

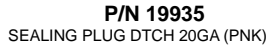

MALE'S

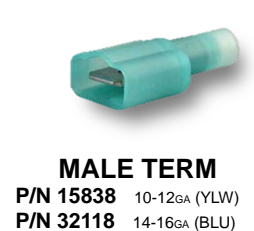
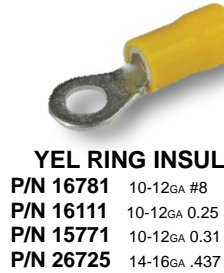
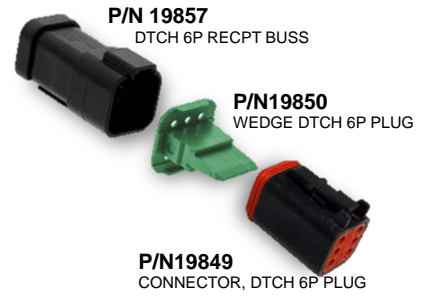
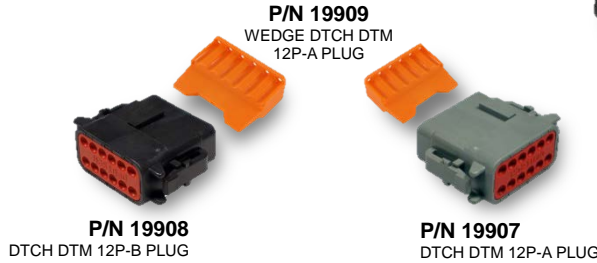
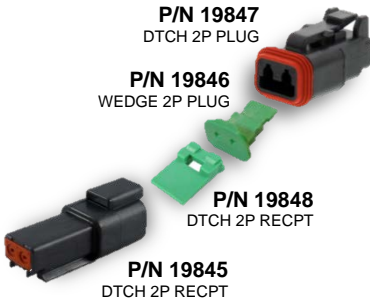

F2435-0
06/16/16
I:\FORMS

HOUSTON, TEXAS
FAX: (800) 824-5559 (USA & Canada)
FAX: (713) 688-6324
PHONE: (713) 688-5533
www.liftmoore.com

THIS PAGE INTENTIONALLY LEFT BLANK

SECTION 3 CRANE SPECIFICATIONS

MODEL 3200 CRANES

MOMENT RATING 10 000 FT-LBS

MAX SINGLE LINE LOAD 1 600 LBS
MAX DOUBLE LINE LOAD 2 874 LBS

LIFTING CAPACITIES AT VARIOUS LOAD RADII:

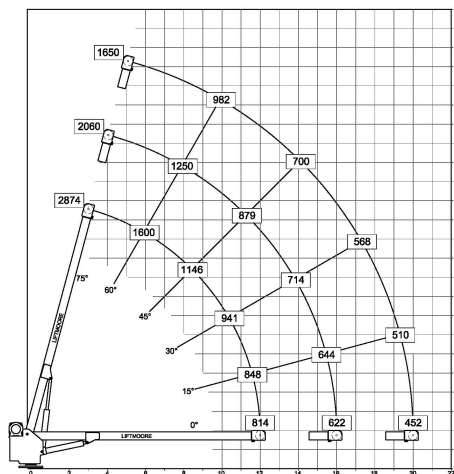

POWERED FUNCTIONS AND EXPECTED TIMES:

WINCH	UP: 12 s	DOWN: 13.5 s	3 REVOLUTION
BOOM ELEVATION	UP: 18 s	DOWN: 17 s	
BOOM EXTENSION	OUT: 30 s	IN: 30 s	
ROTATION	90°	13 s	

ELECTRICAL:

VOLTAGE	12 VDC
FUSE	15 AMP
CIRCUIT BREAKER	150 AMP

NOTE: FUNCTION TIMES ARE BASED ON THESE INPUT VALUES



F1315-E
10/5/15

HOUSTON, TEXAS
FAX: (800) 824-5559 (USA & Canada)
FAX: (713) 688-6324
PHONE: (713) 688-5533
www.liftmoore.com

PERIODIC MAINTENANCE SCHEDULE MODEL 3200 CRANES		
BOLTS		
MOUNTING BOLTS	1/2-13 GRADE 8 TORQUE 110 FT-LBS DRY	EVERY 4 MONTHS
LUBRICATION		
GREASE FITTINGS	SEE DRAWING	EVERY OTHER WEEK
HYDRAULIC FLUID	STANDARD Chevron AW Hydraulic Oil 46 or equivalent SAE 15 weight oil COLD WEATHER AW 32 or equivalent SAE 10 weight oil	CHECK DAILY, FILL AS NEEDED
BEARINGS	Oil Center Research PM 600 Military grease or equivalent Benton Based Grease NLGI Grade 2	EVERY 6 HOURS OF OPERATION

OTHER MAINTENANCE

ROTATION GEAR SETTING

See the Rotation Components drawing for adjustment procedure if backlash becomes so great that excessive boom movement occurs. Factory setting is such that the displacement of the retracted boom tip is less than 1 inch.

WINCH

The winch is factory lubricated and should not require further lubrication in its lifetime. The winch brake cannot be adjusted. If brake drift is more than 1 inch under full load then it must be replaced.



CRANE LUBRICATION POINTS

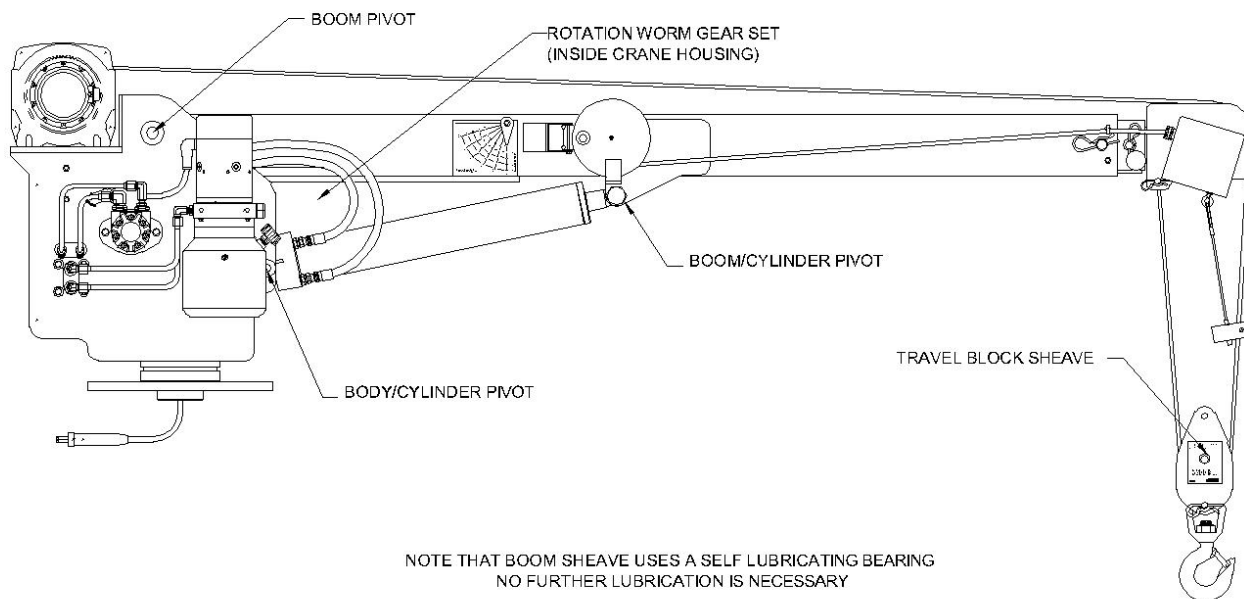

Houston TX
(713)-688-5533
www.liftmoore.com

DRWN BY: BLF
DATE: 3/18/03

CRANE LUBRICATION POINTS 8.1K-16K

DRAWING NO.
50460-A



F1315-E
10/5/15

HOUSTON, TEXAS
FAX: (800) 824-5559 (USA & Canada)
FAX: (713) 688-6324
PHONE: (713) 688-5533
www.liftmoore.com

THIS PAGE INTENTIONALLY LEFT BLANK



F1315-E
10/5/15

HOUSTON, TEXAS
FAX: (800) 824-5559 (USA & Canada)
FAX: (713) 688-6324
PHONE: (713) 688-5533
www.liftmoore.com

LIST FOR BOX, CRANE PARTS 3200REE

Items with * have detailed DWG's.
P/N 28949 - BOX, CRANE PARTS 3200REE

- 1) P/N 28948 - MANUAL, CRANE 3200REE-12-20..... 1pc
- 2) P/N 25866 - WIRE, BATTERY #1 X 30' W\MECON..... 1pc
- 3) P/N 26084 - WIRE, GROUND 1/0 X 36' LONG..... 1pc
- 4) P/N 30815 - SCREW, HHC 0.50-13 X 2.50 GR8..... 4pcs
- 5) P/N 30835 - NUT, HEX NYLOC 0.50-13 GRADE 8 PLATED..... 4pc
- 6) P/N 16878 - BREAKER, CIRCUIT 150 AMP..... 2pcs
- 7) P/N 16915 - TERMINAL, LUG #1 GA 0.25 DIA..... 2pcs
- 8) P/N 30766 - SWITCH, DISCONNECT..... 1pc
- 9) P/N 17010 - BRACKET, SWITCH MNT. ELE. CRN..... 1pc
- 10) P/N 17063 - TERMINAL, LUG #1 GA 0.37 DIA..... 2pcs
- 11) P/N 18600 - PLATE, CRANE-TRUCK STABILITY CHART..... 1pc
- 12) P/N 24893 - DECAL, LOAD CAPACITY 10K-12-20..... 1pc
- 13) P/N 23144 - LEVEL AND TAPE ASSEMBLY... .. 1pc
- 14) P/N 27490 - SWITCH, DISCONNECT COVER PLATE..... 1pcs



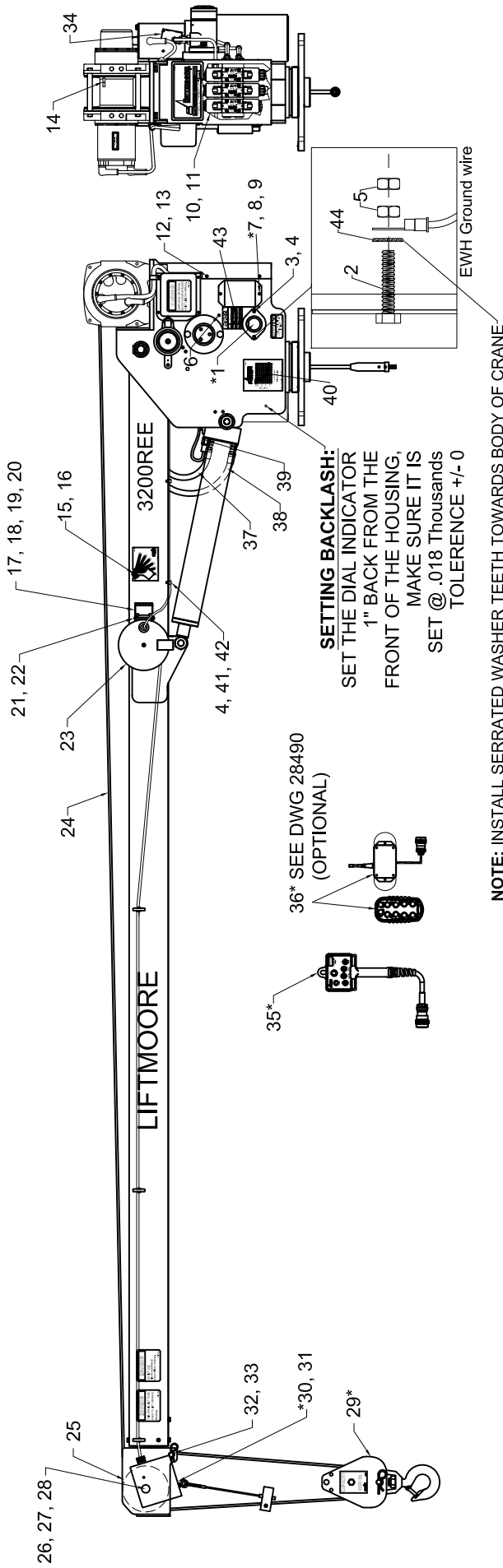

ITEMS WITH * HAVE DETAIL DRAWINGS

#	PN	DESCRIPTION	QTY	#	PN	DESCRIPTION	QTY	#	PN	DESCRIPTION	QTY
1	25046	EWHD TCH ELEC 3200REE W/E-STOP	1	18	30833	NUT, HEX NYLOC 0.25-20 GR2	2	35	23197	CONTROL, PENDANT 25"	1
2	31189	SCREW, HHC 0.25-20 X 1.25 GR5	2	19	31110	WASHER, FLAT 0.25 GR5 PLATED	2	36	23821	BOX, FM PARTS KH ELEC I/O 14P	1
3	30809	SCREW, HHC 0.25-20 X 0.50 GR5	2	20	30457	SCREW, HHC 0.25-20 X 0.75 GR5	2	37	32968	HOSE, HYD #4 37.50"	1
4	30889	WASHER, LOCK 0.25 GR5 PLATED	4	21	33410	SCREW, MH RD 10-24 X 3.00	1	38	32969	HOSE, HYD #4 44.00"	1
5	30830	NUT, HEX 0.25-20 GR5 PLATED	2	22	33409	NUT, HEX NYLOC 10-24 GR2	1	39	25825	SWITCH, PRES ASSY 1450PSI DTCH	1
6	30989	SCREW, HWHSMS #8 X 0.50	1	23	29822	REEL, CORD 20 FT ASSY DTCH	1	40	24922	PLATE, SERIAL 3200/1032-12-20	1
7	22209	BOARD, RELAY 3RD G X	1	24	34208	ROPE, WIRE 0.25 X 85' W/THB&LP	1	41	24960	CLAMP, HOSE SUPPORT 0.25 ID	3
8	17164	SCREW, SOC HD 10-24 X 0.625 SS	2	25	33058	SHEAVE ASSY 5.90PD X 0.25 ROPE	1	42	26582	SCREW, SOC HD 0.25-20 X 0.37SS	3
9	32639	WASHER, LOCK # 10	2	26	34468	SCREW, SHEAVE SINGLE 1-8 3.25	1	43	27910	DECAL, ERROR CODES RELAY BOARD	1
10	24432	VALVE ASSY 4W/3P/12V/OC DTCH	3	27	31258	WASHER, FLAT 1.00 SAE GRADE 8	1	44	21520	WASHER, LOCK 0.25 STAR	1
11	30956	SCREW, SOC HD 10-24 X 2.00	12	28	30838	NUT, HEX NYLOC 1.00-8 GRADE 5	1	NOT SHOWN:			
12	24442	COVER, BACK 3200 PLASTIC	1	29	22556	BLOCK, TRAV ASSY 3.2K lbs/4.0D	1	MH*01143	CAP, BREATHER 3/4 NPT-MONARCH	1	
13	32589	SCREW, HWHSMS 0.25-20 X 0.75	4	30	22908	ATB ASSY, DEUTSCH CONNECTOR	1	19847	CONNECTOR, DTCH 2P PLUG	1	
14	70022	WEDGE, WIRE ROPE ANCHOR	1	31	32957	CLAMP, HOSE SUPPORT 0.62 ID	1	19845	CONNECTOR, DTCH 2P RECPT	1	
15	22394	PENDULUM, LOAD RADIUS DIA, HD	2	32	22553	PIN, CLEVIS 0.56 X 2.5 PLATED	1	19846	WEDGE, DEUTSCH 2P PLUG	1	
16	31017	SCREW, SHOULDER 0.31-18 X 0.75	2	33	31603	CLIP, HAIRPIN 0.50 - 0.62	1	19848	WEDGE, DEUTSCH 2P RECPT	1	
17	70012	BRACKET, CORD REEL	1	34	23123	PRESSURE GAUGE, 0-3000 PSI	1	SEE CHART FOR DECAL KIT			

LIFTMOORE
TRUCK CRANES

Houston TX
(713)-688-5533
www.liftmoore.com

CRANE ASSY 3200REE-12-20

HORN, L.S.ATB; 3RD GEN. R.B. ROTATION ADJUST

DRAWING NO.
28947-0

DRWN BY: JE

DATE: 8/2/19

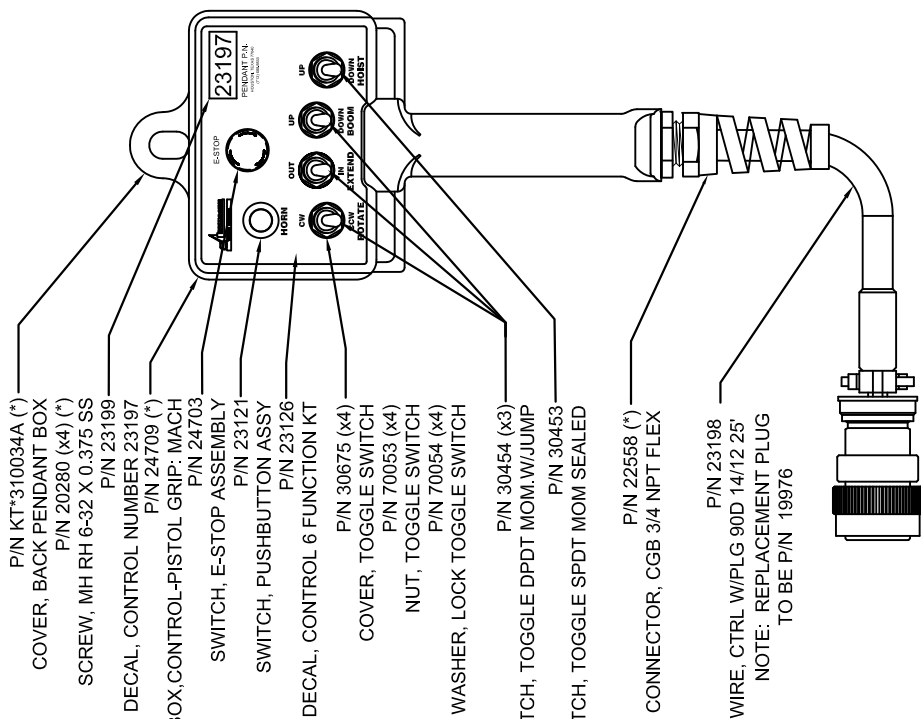

- P/N KT*310034A (*)
- COVER, BACK PENDANT BOX
- P/N 20280 (x4) (*)
- SCREW, MH RH 6-32 X 0.375 SS
- P/N 23199
- DECAL, CONTROL NUMBER 23197
- P/N 24709 (*)
- BOX, CONTROL-PISTOL GRIP: MACH
- P/N 24703
- SWITCH, E-STOP ASSEMBLY
- P/N 23121
- SWITCH, PUSHBUTTON ASSY
- P/N 23126
- DECAL, CONTROL 6 FUNCTION KT
- P/N 30675 (x4)
- COVER, TOGGLE SWITCH
- P/N 70053 (x4)
- NUT, TOGGLE SWITCH
- P/N 70054 (x4)
- WASHER, LOCK TOGGLE SWITCH
- P/N 30454 (x3)
- SWITCH, TOGGLE DPDT MOM.W/UJUMP
- P/N 30453
- SWITCH, TOGGLE SPDT MOM SEALED
- P/N 22558 (*)
- CONNECTOR, CGB 3/4 NPT FLEX
- P/N 23198
- WIRE, CTRL W/PLG 90D 14/12 25'
- NOTE: REPLACEMENT PLUG TO BE P/N 19976

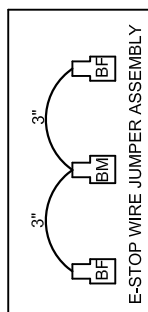

NOTE: JUMPER WIRES ARE 16 GA WHITE WIRE P/N 15151.

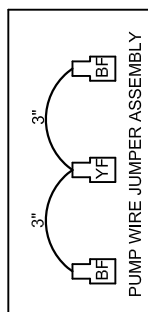

NOTE: JUMPER WIRES ARE 16 GA WHT/BLK WIRE P/N 15826.

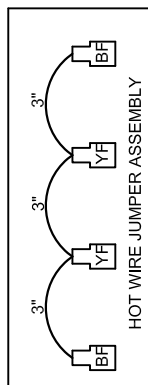

NOTE: JUMPER WIRES ARE 16 GA WHITE WIRE P/N 15151.

PIN LOCATION	WIRE FUNCTION	WIRE COLOR
A	HORN	BLU/WHT
C	E-STOP	BLK/WHT
E	POWER	WHT
F	ROTATION CW	RED
G	ELEV UP	GRN
H	ELEV DWN	ORN
J	HOIST UP	BLU
K	PUMP SOLN.	WHT/BLK
L	ROTATION CCW	RED/BLK
M	EXTEND IN	GRN/BLK
N	EXTEND OUT	ORG/BLK
P	HOIST DOWN	BLK

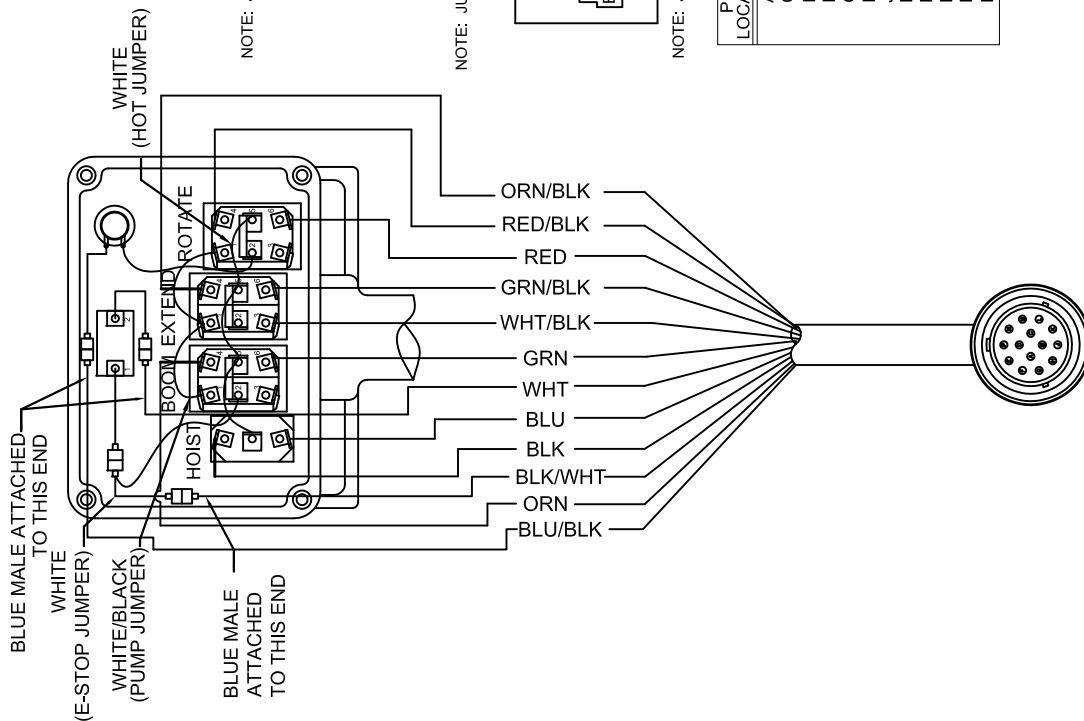

- BLUE MALE ATTACHED TO THIS END (E-STOP JUMPER)
- WHITE (HOT JUMPER)
- WHITE/BLACK (PUMP JUMPER)
- HOIST
- BOOM
- EXTEND
- ROTATE
- ORN/BLK
- RED/BLK
- RED
- GRN/BLK
- WHT/BLK
- GRN
- WHT
- BLU
- BLK
- BLK/WHT
- ORN
- BLU/BLK



Houston TX
(713)-688-5533
www.liftmoore.com

DRWN BY: KSP

DATE: 7/2/09

DRAWING NO.

23197-F

LIFTMOORE P/N: 28470-RECEIVER



INCLUDES TWO 65 LB MOUNTING MAGNETS FOR SIMPLE INSTALLATION OF THE RECEIVER AND ELIMINATION OF DRILLING TO THE CRANE

WIRE COLOR CODE	
PIN	DESCRIPTION
A	HORN
B	GROUND
C	E-STOP
D	N/C
E	POWER
F	ROTATION CW
G	BOOM UP
H	BOOM DOWN
J	WINCH UP
K	PUMP
L	ROTATION CCW
M	BOOM OUT
N	BOOM IN
P	WINCH DOWN

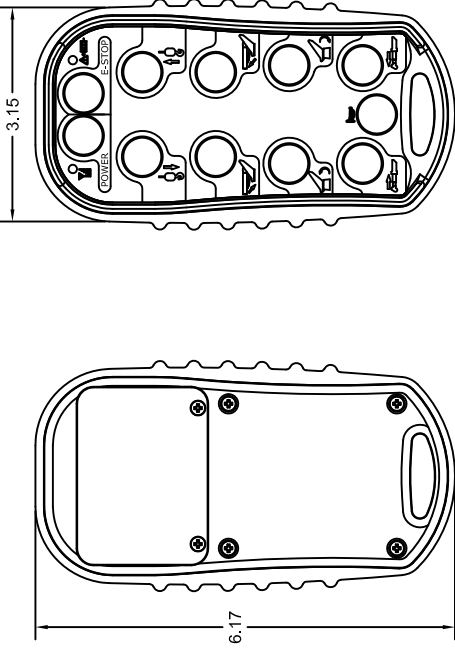
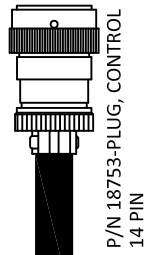

LIFTMOORE P/N: 28469-TRANSMITTER

USES TWO (2) AA ALKALINE BATTERIES

ERROR CODE NUMBER IS THE NUMBER OF RED LIGHT BLINKS BETWEEN EVERY PAUSE.

TRANSMITTER ERROR CODE CHART

ERROR CODE	PROBABLE CAUSE
1	RF COMMUNICATION PROBLEM
2	LOW TRUCK BATTERY VOLTAGE (LESS THAN 11 VOLTS)
3	FAULTY CIRCUIT TO HOIST DOWN
4	FAULTY CIRCUIT TO BOOM UP
5	FAULTY CIRCUIT TO ROTATION CW
6	FAULTY CIRCUIT TO ROTATION CCW
7	FAULTY CIRCUIT TO EXTENSION IN
8	FAULTY CIRCUIT TO PUMP RELAY
9	TRANSMITTER NOT NEUTRAL (SWITCH ON AT POWER UP)

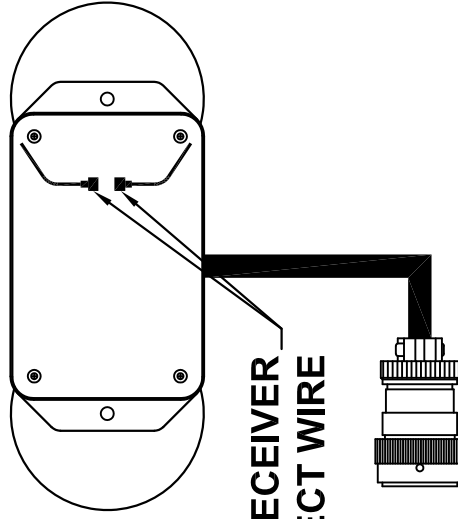

NOTE: OPEN RECEIVER AND DISCONNECT WIRE

TEACH ID CODE:

To synchronize a new transmitter and receiver together, use the following procedure:

1. Turn both transmitter and receiver off
2. To get the transmitter into TEACH ID mode, press and hold the POWER button for 10 seconds. Both LEDs start blinking.
3. Turn on the receiver.
4. Teach complete
5. **SEE NOTE**



Houston TX
(713)-688-5533
www.liftmoore.com

DRWN BY: JE

DATE: 4/18/17

CONTROL, FM ASSY KT MEGA ELE.HORN
TRANS./RECIEVER PRO. SET

DRAWING NO.

28490-B

P/N KT*61007FA
COVER & ENCLOSURE LIMITING SYS

GREEN STATUS LED

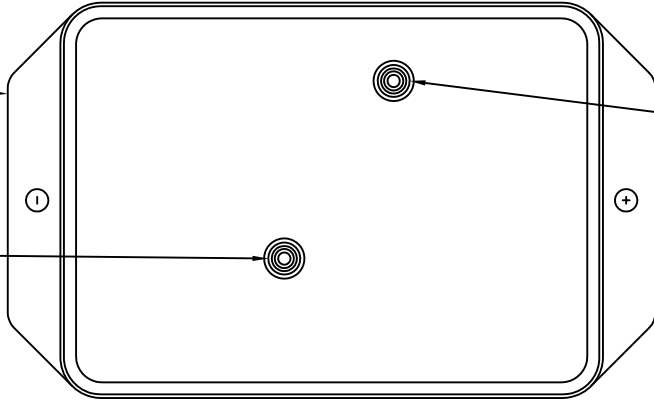

RED ERROR CODE LED

3RD GENERATION RELAY BOARD	
Pin No.	Description
1	Ground
2	No Connection (Not Used)
3	No Connection (Not Used)
4	Pressure Switch Input
5	ATB Switch Input
6	Winch Up Switch Input
7	Elevation Down Switch Input
8	Extension Out Switch Input
9	Extension Out Output
10	Elevation Down Output
11	Winch Up Output
12	Supply (9 To 30 VDC)

ERROR CODE CHART

ERROR CODE COUNT	PROBABLE CAUSE
1	No Input To ATB Switch Input
2	No Input To Pressure Switch Input Or Overload Condition
3	Short Or Overload To Winch Up Output
4	Short Or Overload To Elevation Down Output
5	Short Or Overload To Extension Out Output
6	Trigger Input Out Of Range

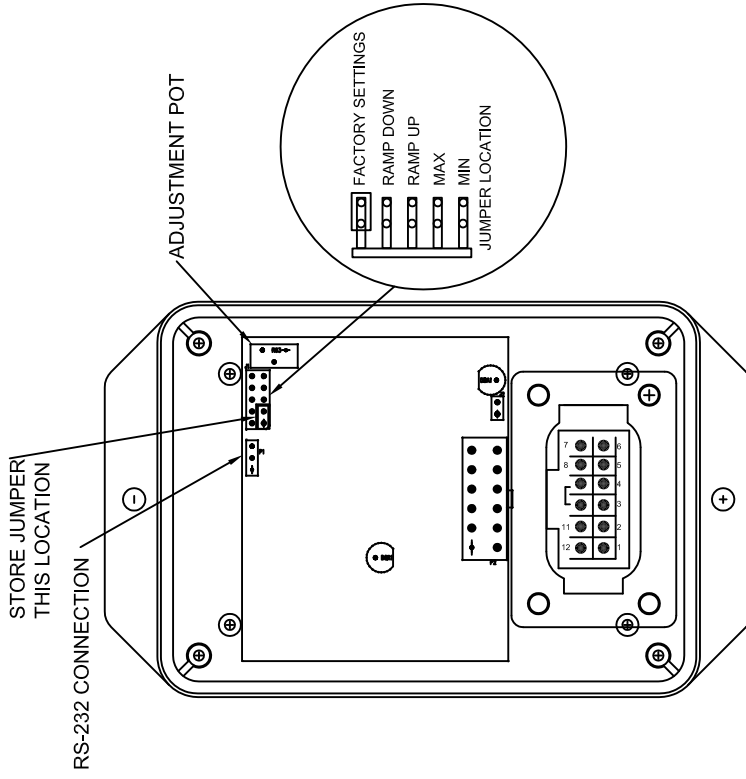

To Display an error code, the controller turns on and off the error code LED a certain number of times with a pause at the end. It repeats the code until the problem is resolved. The **Error Code Chart** is provided to assist the service personnel in troubleshooting the system.

DRWN BY: JC

DATE: 06/05/07

BOARD, RELAY POT 3RD G X
KAR-TECH;3RD GEN.

DRAWING NO.

22209-D

Houston TX
(713)-688-5533
www.liftmoore.com



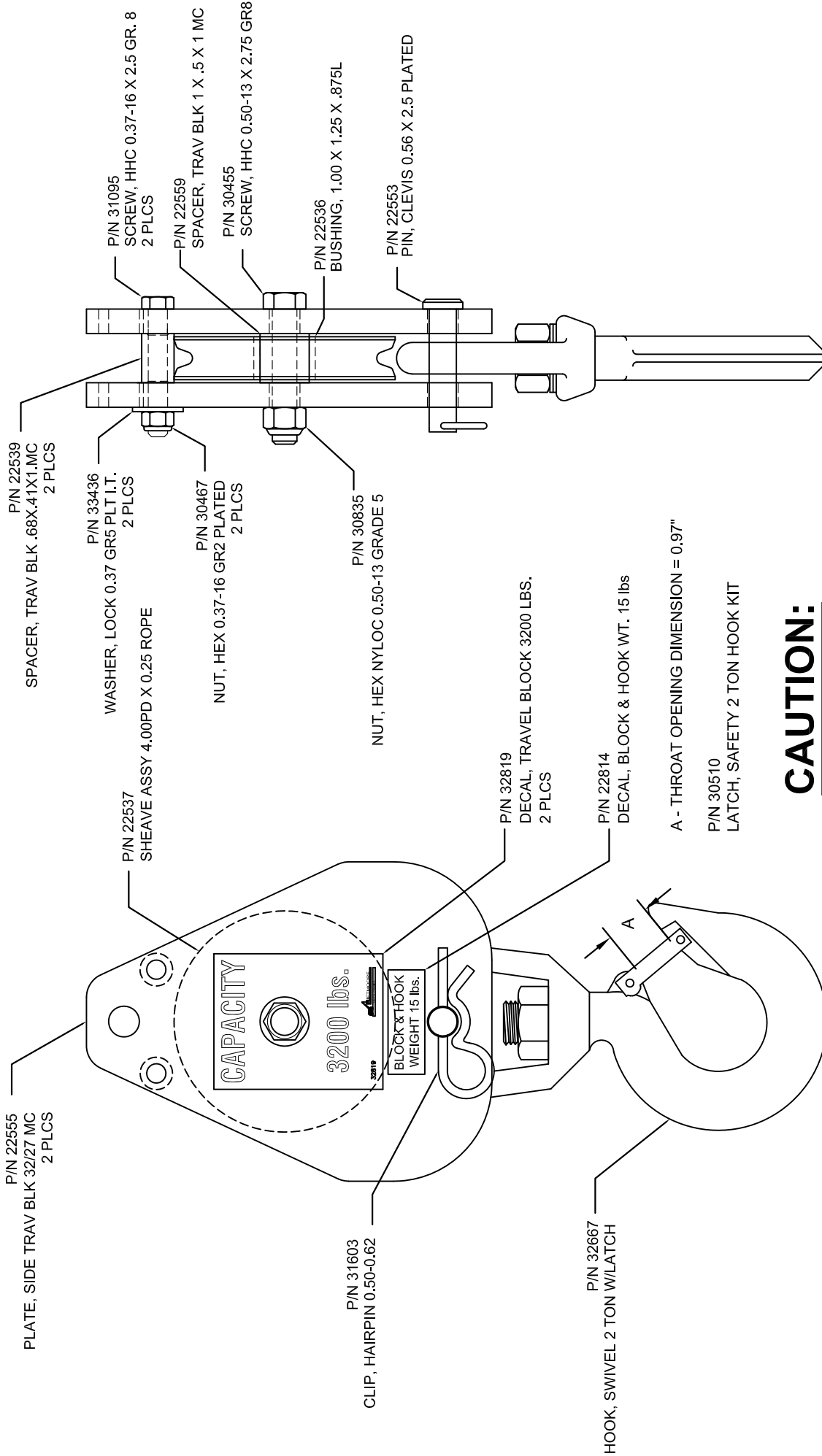

CAUTION:

NEVER USE A HOOK WHOSE THROAT OPENING HAS BEEN INCREASED, OR WHOSE TIP HAS BEEN BENT MORE THAN 10 DEGREES OUT OF PLANE FROM THE HOOK BODY, OR IS IN ANY WAY DISTORTED OR BENT.

DRAWING NO.
22556-C

BLOCK, TRAV ASSY 3.2K lbs/4.0D
4,00PD X 0.25 ROPE; 3200 LBS

DRWN BY: JC
DATE: 6/23/08

Houston TX
(713)-688-5533
www.liftmoore.com



NOTE: WIRE SHOULD BE SECURED TO SHEAVE BOLT TO ENSURE THAT IT DOES NOT INTERFERE WITH THE LEVER

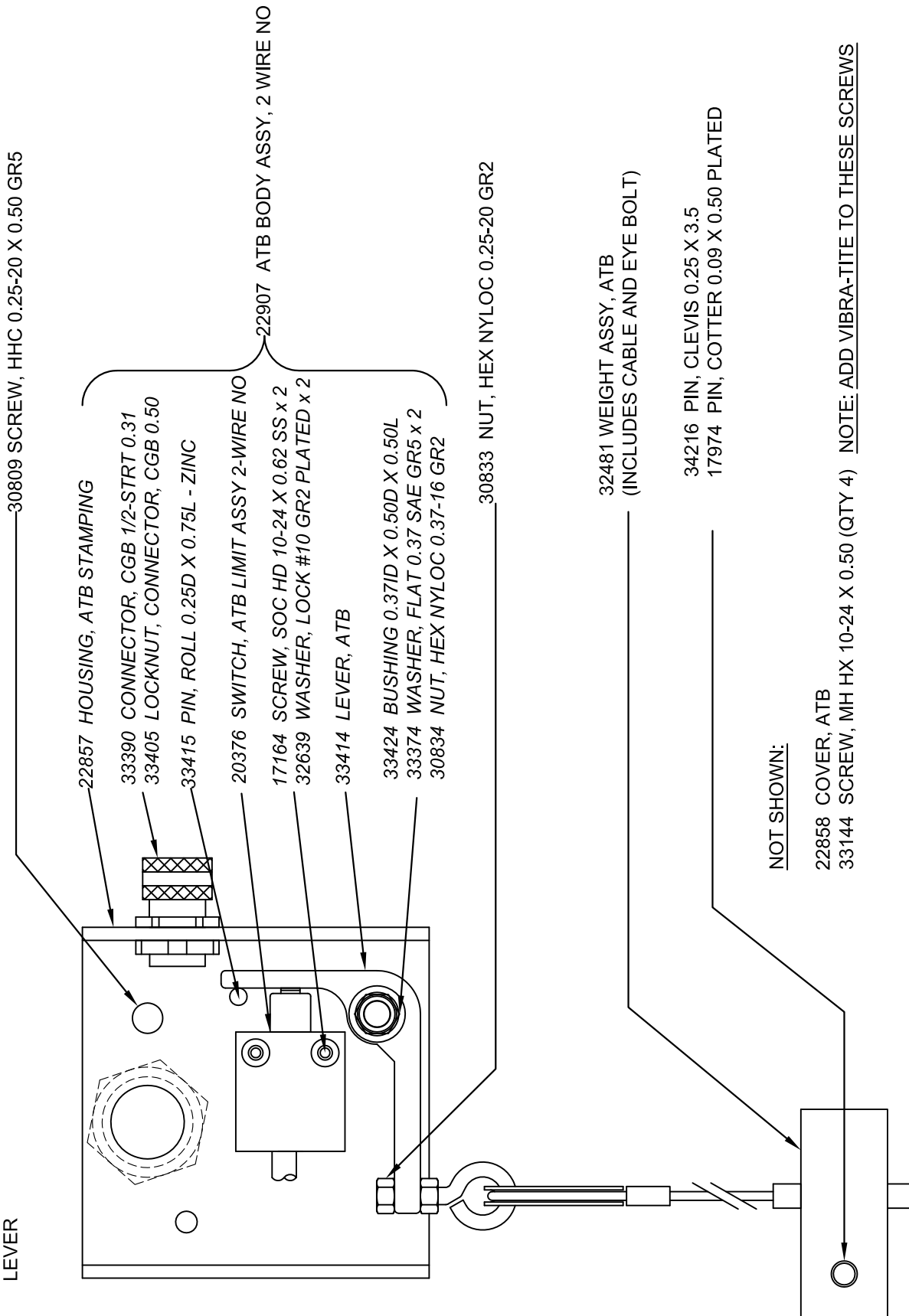

DRAWING NO. 22908-B

ATB ASSY, DEUTSCH CONN
TWO-WIRE NORMAL OPEN; LEFT SIDE

DRWN BY: JC
DATE: 07/02/09

Houston TX
(713)-688-5533
www.liftmoore.com



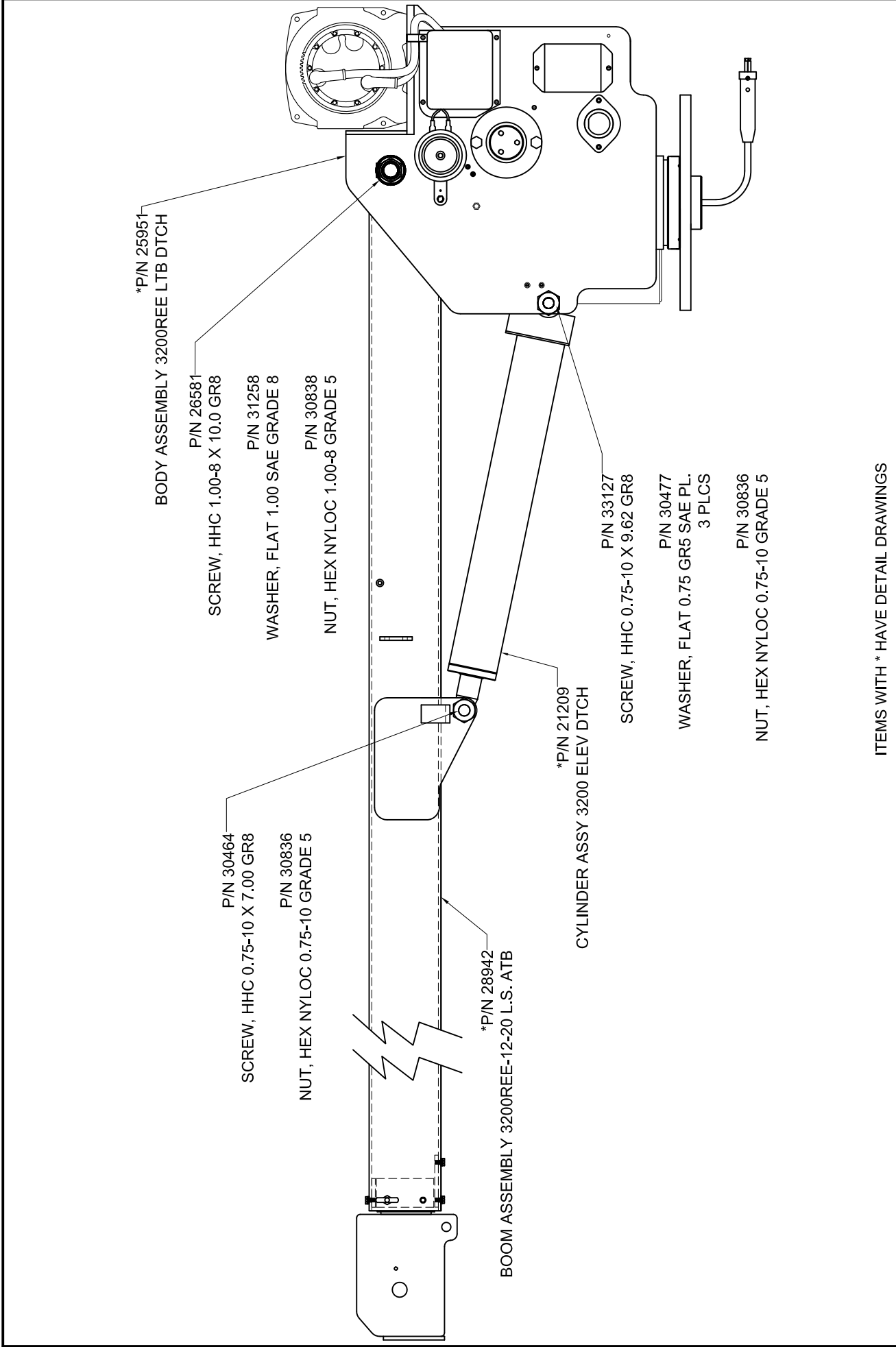

*P/N 25951-
BODY ASSEMBLY 3200REE LTB DTCH

P/N 26581
SCREW, HHC 1.00-8 X 10.0 GR8

P/N 31258
WASHER, FLAT 1.00 SAE GRADE 8

P/N 30838
NUT, HEX NYLOC 1.00-8 GRADE 5

P/N 30464
SCREW, HHC 0.75-10 X 7.00 GR8

P/N 30836
NUT, HEX NYLOC 0.75-10 GRADE 5

*P/N 28942
BOOM ASSEMBLY 3200REE-12-20 L.S. ATB

*P/N 21209
CYLINDER ASSY 3200 ELEV DTCH

P/N 33127
SCREW, HHC 0.75-10 X 9.62 GR8

P/N 30477
WASHER, FLAT 0.75 GR5 SAE PL.
3 PLCS

P/N 30836
NUT, HEX NYLOC 0.75-10 GRADE 5

ITEMS WITH * HAVE DETAIL DRAWINGS

Houston TX
(713)-688-5533
www.liftmoore.com



BOOM-BODY ASSY 3200REE-12-20 DTCH
ATB LEFT SIDE, W/HORN & E-STOP, ROTATION ADJUST

DRAWING NO.

28946-0

FOR PRESSURE SWITCH PART NUMBER SEE CRANE ASSEMBLY DRAWING

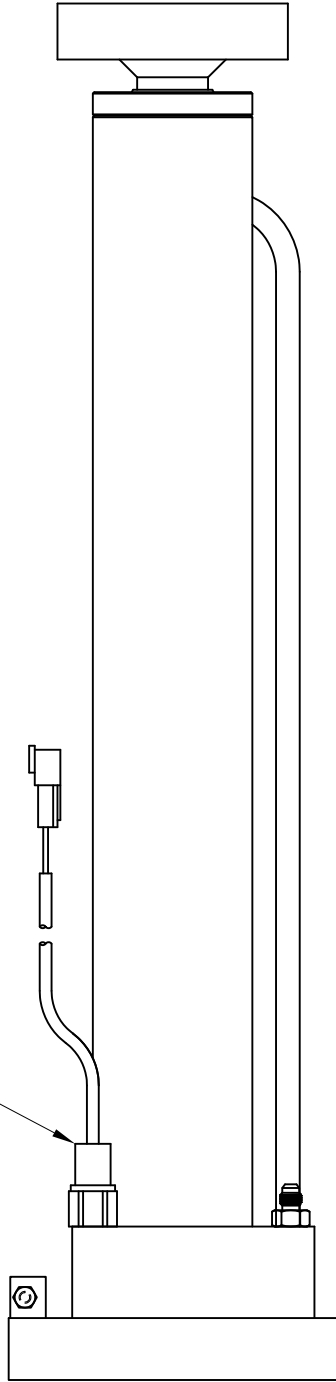

REPLACEMENT PARTS FOR CYLINDER	
DESCRIPTION	PART NUMBER
SEAL KIT	TM*SK-0000148
COUNTER BALANCE VALVE	30851

P/N 32400
ADAPTER, 4MJ-6MO
2 PLCS

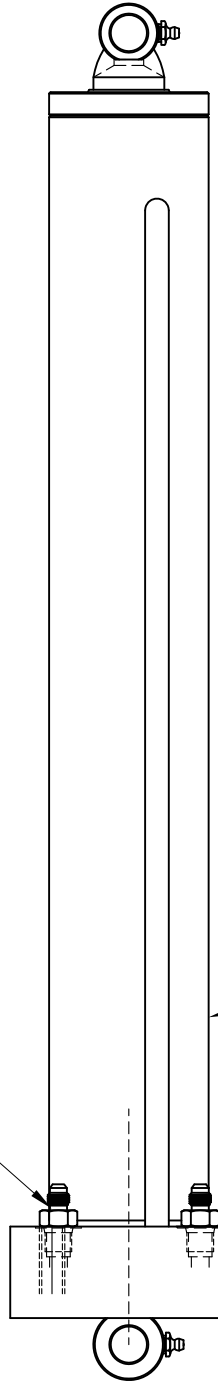

P/N 32867
CYLINDER, 3.0 X 18.5 X 1.25 PE

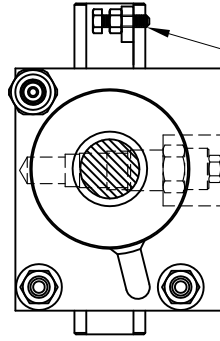

P/N 30810
SCREW, HHC 0.25-20 X 1.00 GR5

P/N 30830
NUT, HEX 0.25-20 GR2 PLATED

FOR UPLIMIT SWITCH



Houston TX
(713)-688-5533
www.iftmoore.com

DRWN BY: JC

DATE: 1/31/08

CYLINDER ASSY 3200 ELEV DTCH

DRAWING NO.

21209-C

NOTE A:
P/N 24698- E-STOP SOLENOID 634-1251-012 12V/ CONT
P/N 26639- PUMP SOLENOID 634-1251-212 12V/ INT

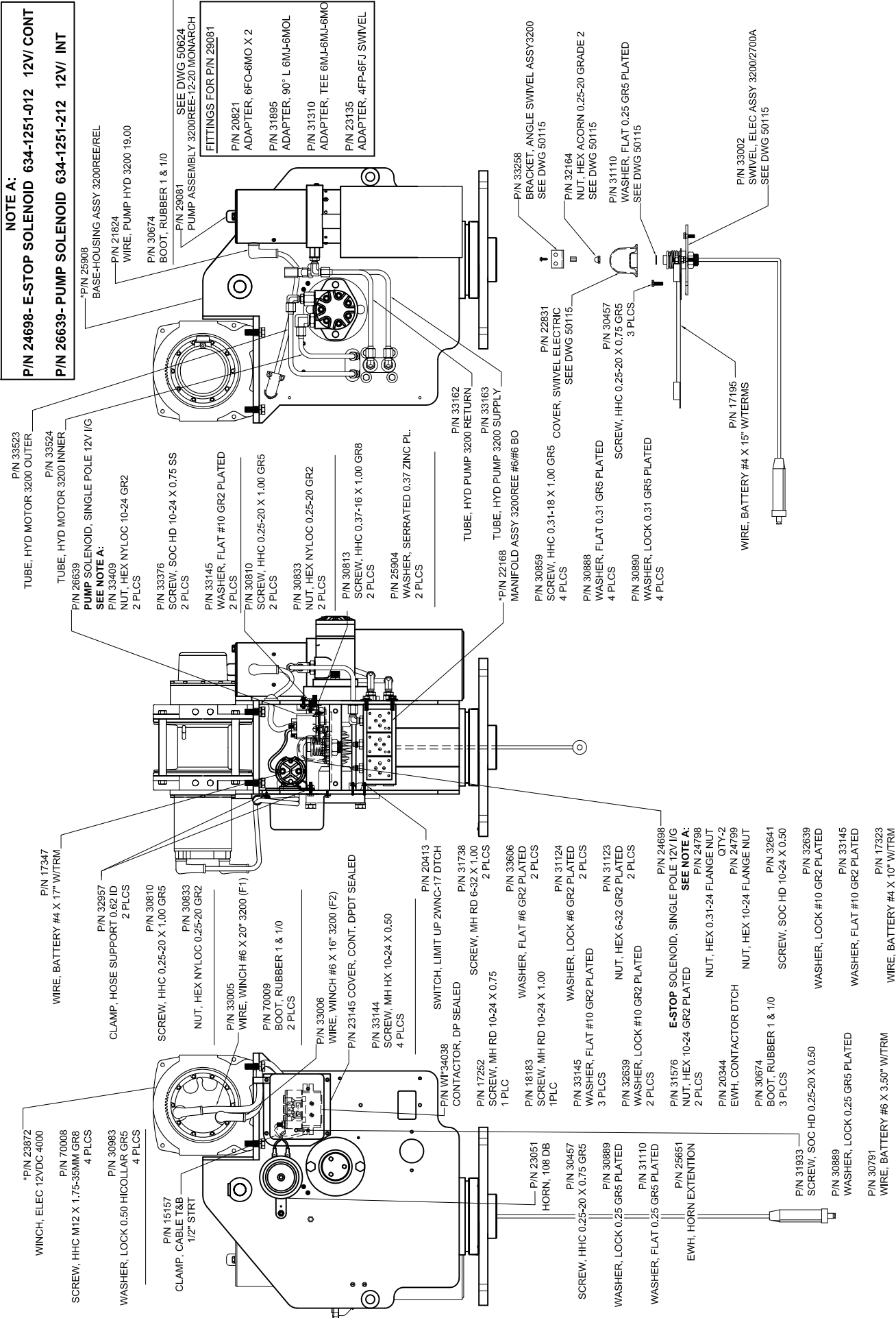

P/N 33523
 TUBE, HYD MOTOR 3200 OUTER
 P/N 33524
 TUBE, HYD MOTOR 3200 INNER
 P/N 26639
 PUMP SOLENOID, SINGLE POLE 12V I/G
 SEE NOTE A:
 P/N 33409
 NUT, HEX NYLOC 10-24 GR2
 2 PLS

P/N 17347
 WIRE, BATTERY #4 X 17" W/TRM
 P/N 32957
 CLAMP, HOSE SUPPORT 0.62 ID
 2 PLS
 P/N 30810
 SCREW, HHC 0.25-20 X 1.00 GR5
 P/N 30833
 NUT, HEX NYLOC 0.25-20 GR2

*P/N 23872
 WINCH, ELEC 12VDC 4000
 P/N 70008
 SCREW, HHC M12 X 1.75-35MM GR8
 4 PLS
 P/N 30983
 WASHER, LOCK 0.50 HICOLLAR GR5
 4 PLS

P/N 33376
 SCREW, SOC HD 10-24 X 0.75 SS
 2 PLS
 P/N 33145
 WASHER, FLAT #10 GR2 PLATED
 2 PLS
 P/N 30810
 SCREW, HHC 0.25-20 X 1.00 GR5
 2 PLS
 P/N 30833
 NUT, HEX NYLOC 0.25-20 GR2
 2 PLS

P/N 33005
 WIRE, WINCH #6 X 20" 3200 (F1)
 P/N 70009
 BOOT, RUBBER 1 & 1/0
 2 PLS
 P/N 33006
 WIRE, WINCH #6 X 16" 3200 (F2)
 P/N 23145 COVER, CONT. DDPDT SEALED
 P/N 33144
 SCREW, MH HX 10-24 X 0.50
 4 PLS

P/N 15157
 CLAMP, CABLE T&B
 1/2" STRT
 P/N 23051
 HORN, 108 DB
 P/N 30457
 SCREW, HHC 0.25-20 X 0.75 GR5
 3 PLS
 P/N 30889
 WASHER, LOCK 0.25 GR5 PLATED
 P/N 31110
 WASHER, FLAT 0.25 GR5 PLATED
 EWH, HORN EXTENSION
 P/N 25651
 P/N 31933
 SCREW, SOC HD 0.25-20 X 0.50
 P/N 30889
 WASHER, LOCK 0.25 GR5 PLATED
 P/N 30791
 WIRE, BATTERY #6 X 3.50" W/TRM

P/N 30813
 SCREW, HHC 0.37-16 X 1.00 GR8
 2 PLS
 P/N 25904
 WASHER, SERRATED 0.37 ZINC PL.
 2 PLS
 P/N 33162
 TUBE, HYD PUMP 3200 RETURN
 P/N 33163
 TUBE, HYD PUMP 3200 SUPPLY
 *P/N 22168
 MANIFOLD ASSY 3200REE #6/6 BO

P/N 20413
 SWITCH, LIMIT UP 2WNC-17 DTCH
 P/N 31738
 SCREW, MH RD 6-32 X 1.00
 2 PLS
 P/N 33606
 WASHER, FLAT #6 GR2 PLATED
 2 PLS
 P/N 31124
 WASHER, LOCK #6 GR2 PLATED
 2 PLS
 P/N 31123
 NUT, HEX 6-32 GR2 PLATED
 2 PLS
 P/N 24698
 E-STOP SOLENOID, SINGLE POLE 12V I/G
 SEE NOTE A:
 P/N 24798
 NUT, HEX 0.31-24 FLANGE NUT
 QTY:2
 P/N 24799
 NUT, HEX 10-24 FLANGE NUT
 P/N 32641
 SCREW, SOC HD 10-24 X 0.50
 P/N 32639
 WASHER, LOCK #10 GR2 PLATED
 P/N 33145
 WASHER, FLAT #10 GR2 PLATED
 P/N 17323
 WIRE, BATTERY #4 X 10" W/TRM

P/N 31576
 NUT, HEX 10-24 GR2 PLATED
 2 PLS
 P/N 20344
 EWH, CONTACTOR DTCH
 P/N 30674
 BOOT, RUBBER 1 & 1/0
 3 PLS
 P/N 31933
 SCREW, SOC HD 0.25-20 X 0.50
 P/N 30889
 WASHER, LOCK 0.25 GR5 PLATED
 P/N 30791
 WIRE, BATTERY #6 X 3.50" W/TRM

SEE DWG 50624
 PUMP ASSEMBLY 3200REE-12-20 MONARCH
 FITTINGS FOR P/N 29081
 P/N 20821
 ADAPTER, 6FO-6MO X 2
 P/N 31895
 ADAPTER, 90° L 6MJ-6MOL
 P/N 31310
 ADAPTER, TEE 6MJ-6ML-6MO
 P/N 23135
 ADAPTER, 4FP-6FJ SWIVEL

P/N 33258
 BRACKET, ANGLE SWIVEL ASSY 3200
 SEE DWG 50115
 P/N 32164
 NUT, HEX ACORN 0.25-20 GRADE 2
 SEE DWG 50115
 P/N 31110
 WASHER, FLAT 0.25 GR5 PLATED
 SEE DWG 50115
 P/N 33002
 SWIVEL, ELEC ASSY 3200/2700A
 SEE DWG 50115

P/N 30859
 SCREW, HHC 0.31-18 X 1.00 GR5
 4 PLS
 P/N 30888
 WASHER, FLAT 0.31 GR5 PLATED
 4 PLS
 P/N 30890
 WASHER, LOCK 0.31 GR5 PLATED
 4 PLS
 P/N 17195
 WIRE, BATTERY #4 X 15" W/TRM

P/N 31576
 NUT, HEX 10-24 GR2 PLATED
 2 PLS
 P/N 20344
 EWH, CONTACTOR DTCH
 P/N 30674
 BOOT, RUBBER 1 & 1/0
 3 PLS
 P/N 31933
 SCREW, SOC HD 0.25-20 X 0.50
 P/N 30889
 WASHER, LOCK 0.25 GR5 PLATED
 P/N 30791
 WIRE, BATTERY #6 X 3.50" W/TRM

ITEMS WITH * HAVE DETAIL DRAWINGS

IFTMOORE
 TRUCK-CRANES

Houston TX
 (713)-688-5533
 www.iftmoore.com

DRWN BY: AA
 DATE: 07/30/13

25951-C
 DRAWING NO.

BODY ASSEMBLY 3200REE-12-20 LTB DTCH
 DTCH CONN., M.P.E-STOP, HORN & ROTATION ADJUST

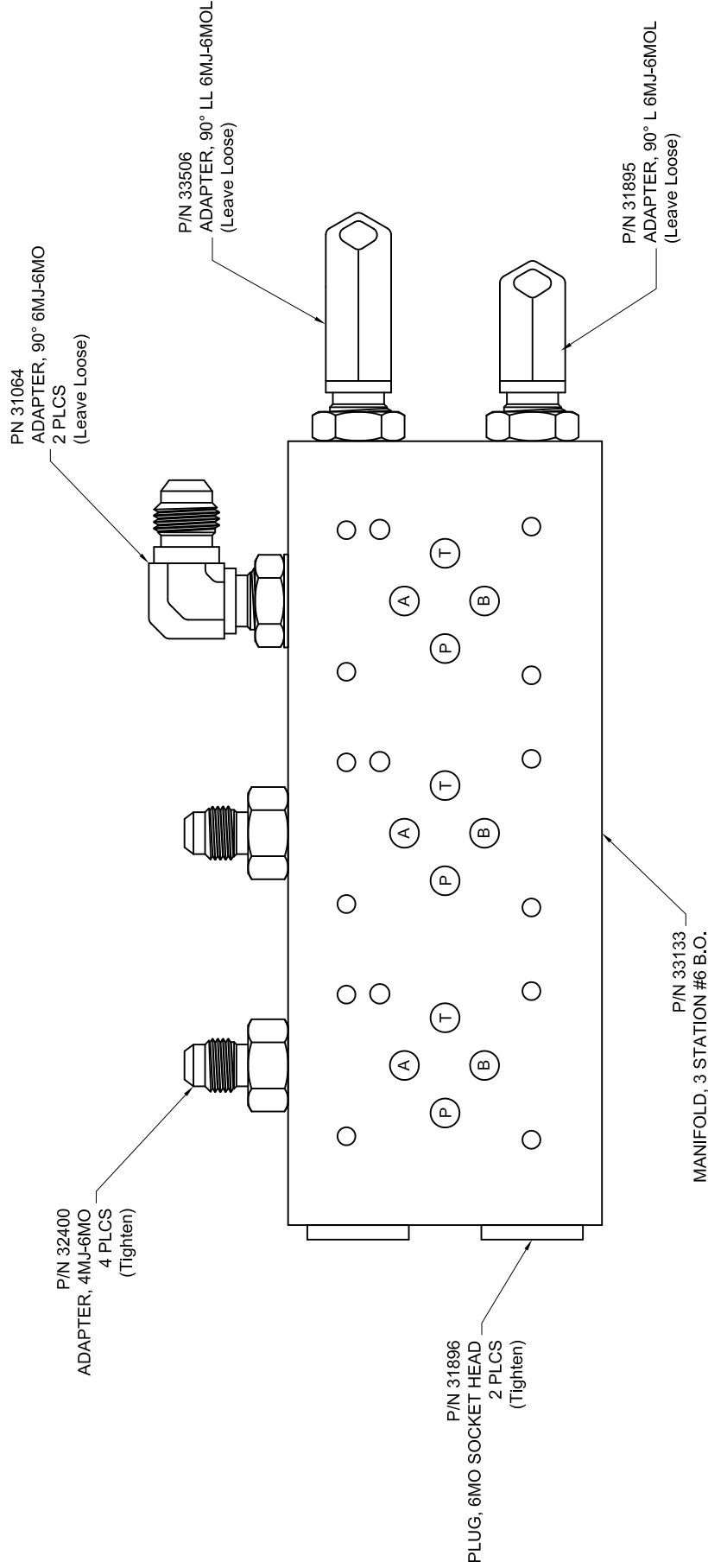

DRAWING NO.
22168-B

MANIFOLD ASSY 3200REE #6/#6 BO

DRWN BY: RLC
DATE: 8/28/06

Houston TX
(713)-688-5533
www.liftmoore.com



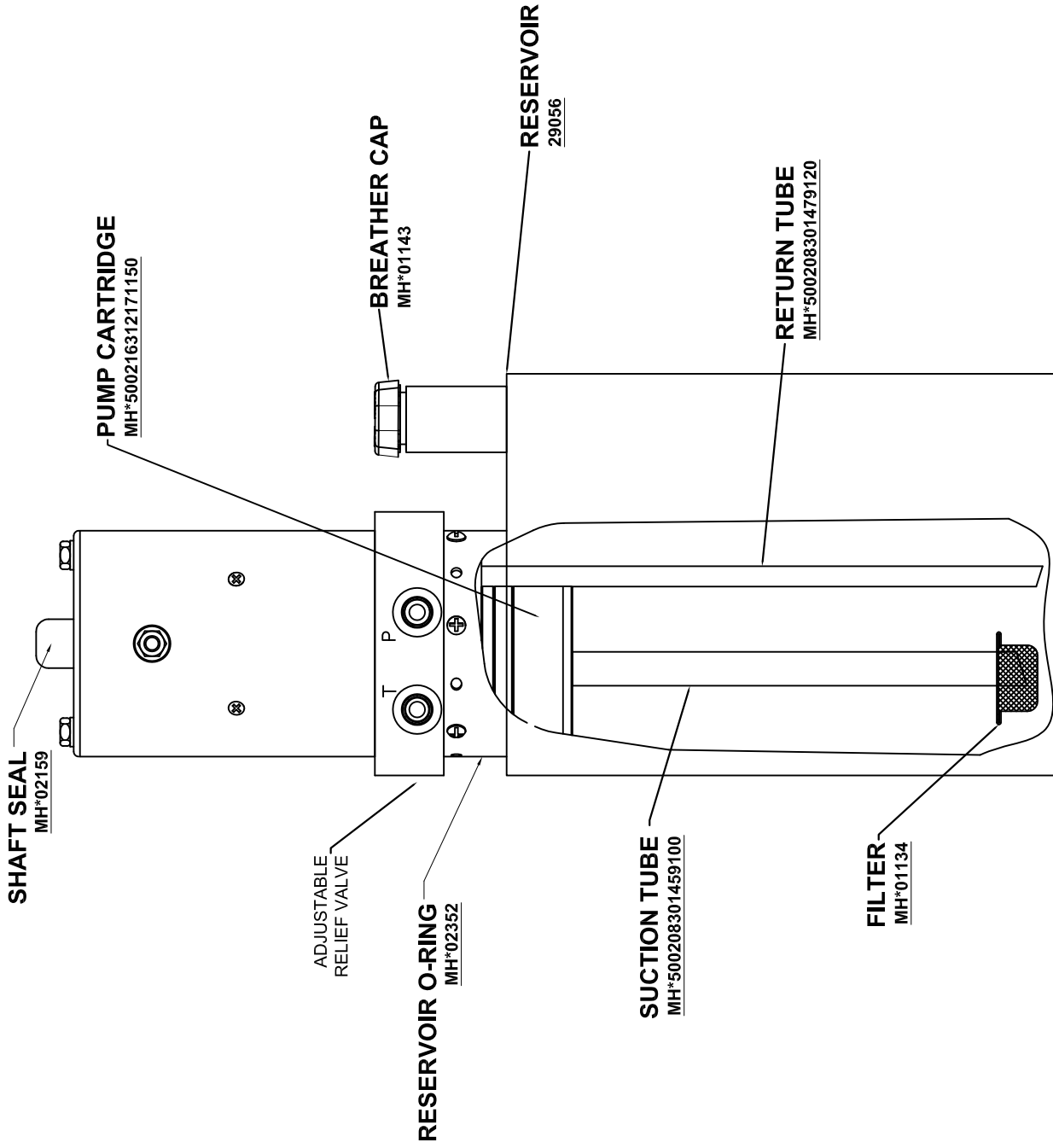

DRAWING NO. 29081-0

PUMP ASSY 3200-12-20

DRWN BY: JE
DATE: 10/18/19

Houston TX
(713)-688-5533
www.liftmoore.com

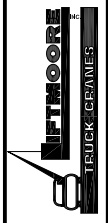

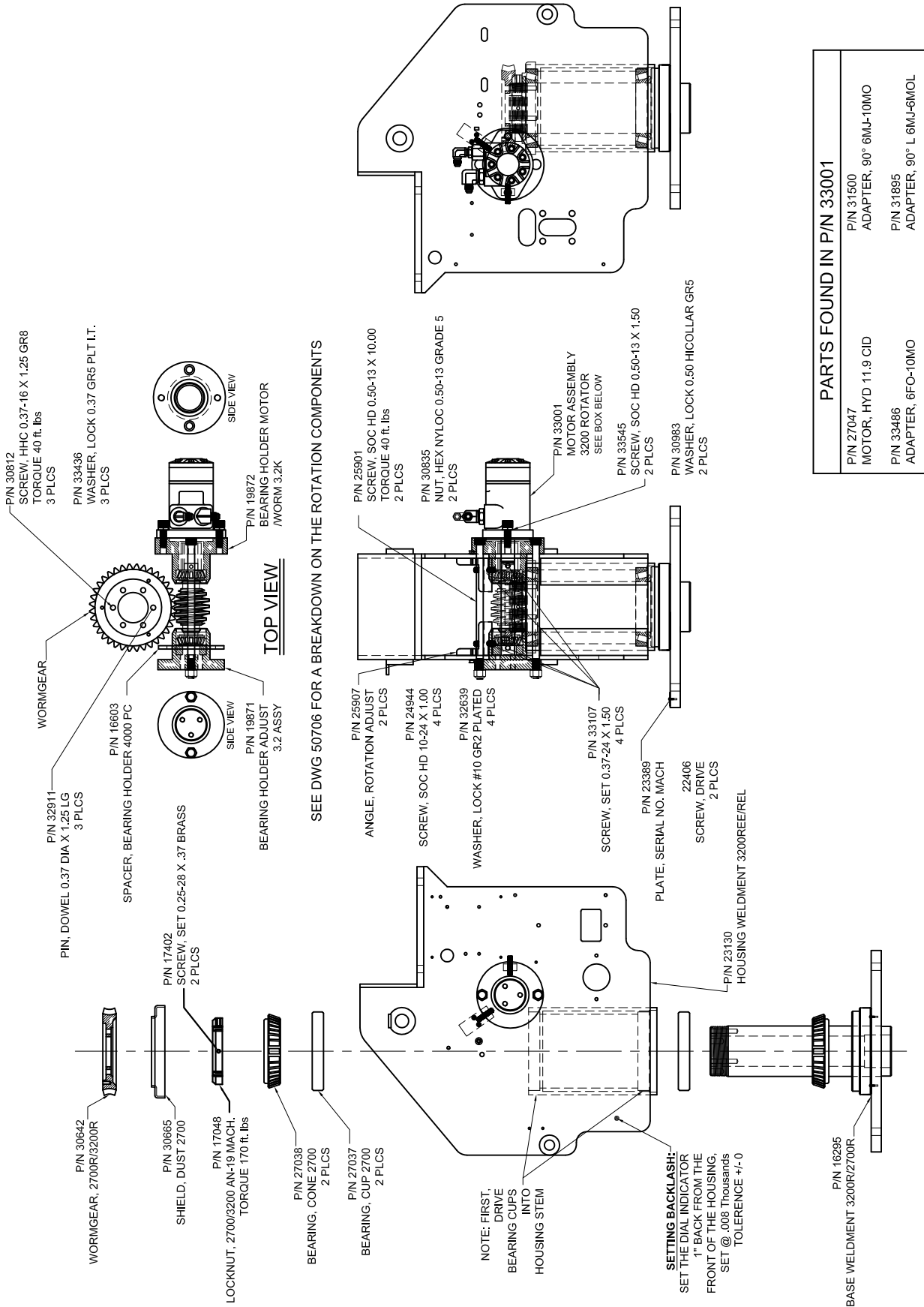

ITEMS WITH * HAVE DETAIL DRAWINGS



Houston TX
(713)-688-5533
www.liftmoore.com

BASE-HOUSING ASSY 3200REE/REL

MONARCH PUMP, E-STOP, HORN & BLOCK ROTATION ADJUST

DRAWING NO.
25908-E

DRWN BY: AA

DATE: 07/19/13

SEE DWG 50706 FOR A BREAKDOWN ON THE ROTATION COMPONENTS

ITEMS WITH * HAVE DETAIL DRAWINGS



BY: JC
DATE: 01/25/08

ROTATION COMPONENTS
ISOMETRIC DWG

DOCUMENT NO.

50706-A

TO ADJUST BACKLASH BETWEEN GEARS:

LOOSEN MOUNTING BOLTS

MAKE SMALL ADJUSTMENTS TO THE BACKLASH ADJUSTMENT SCREWS, NO MORE THAN A 1/4 TURN. ALTERNATE BETWEEN SCREWS SO THAT ALIGNMENT IS MAINTAINED.

SOME PLAY **MUST** BE LEFT BETWEEN THE GEARS OR THE CRANE WILL NOT OPERATE PROPERLY AND EXCESSIVE WEAR AND/OR DAMAGE WILL OCCUR. INITIAL SETTING IS SUCH THAT THE RETRACTED BOOM TIP MOTION IS LESS THAN 1 INCH.

WHEN FINISHED, TORQUE THE MOUNTING BOLTS TO 40 FT-LBS

TO ADJUST PLAY IN WORM MOUNTING:

TIGHTEN THE 3 SET SCREWS IN THE BEARING HOLDER THEN BACK THEM OUT 1 TURN

SCREW THEM BACK IN JUST UNTIL THEY ARE SNUG. OVER TIGHTENING WILL PUT THE WORM AND MOTOR IN A BIND AND IT WILL NOT FUNCTION PROPERLY.

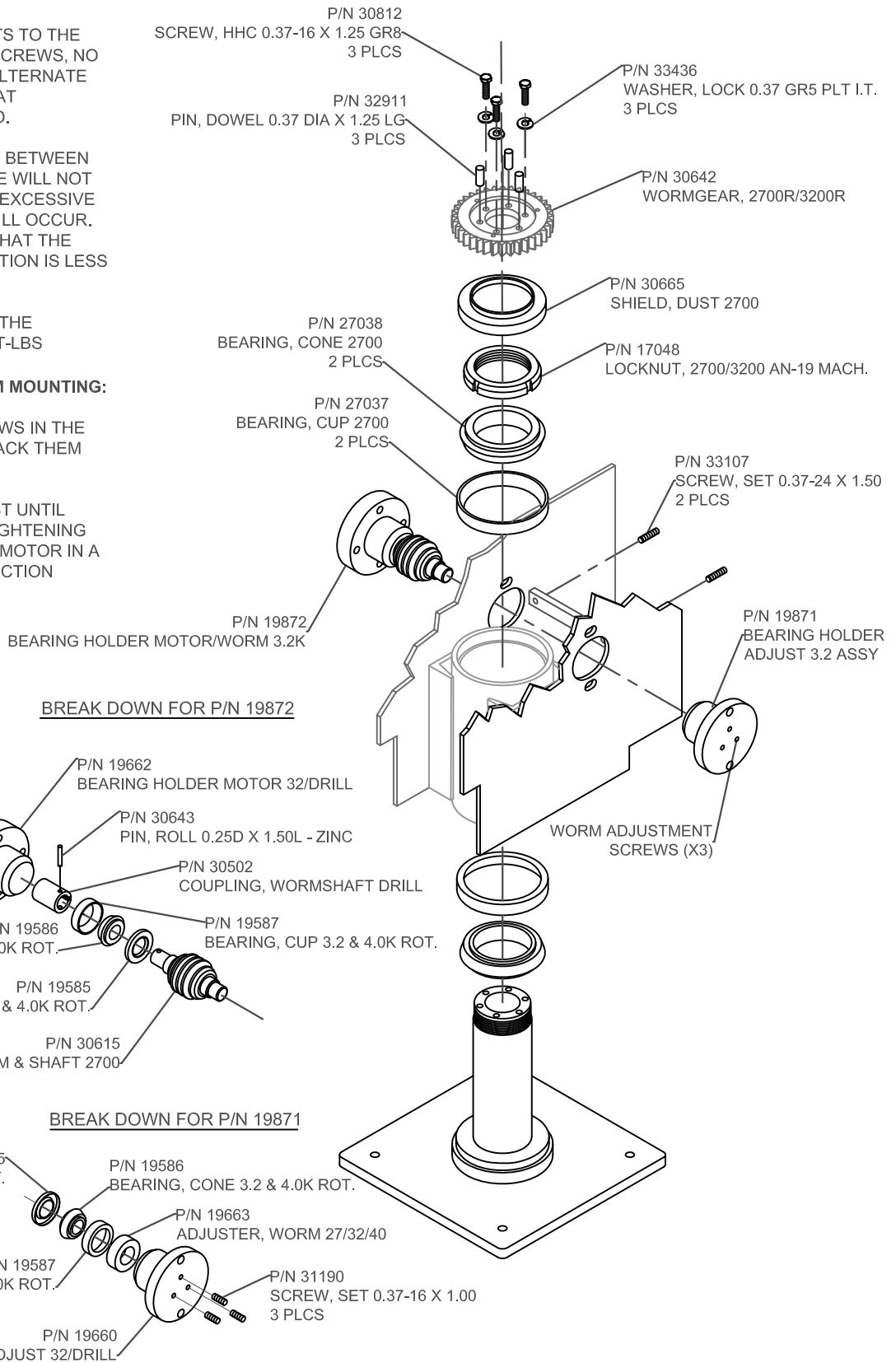

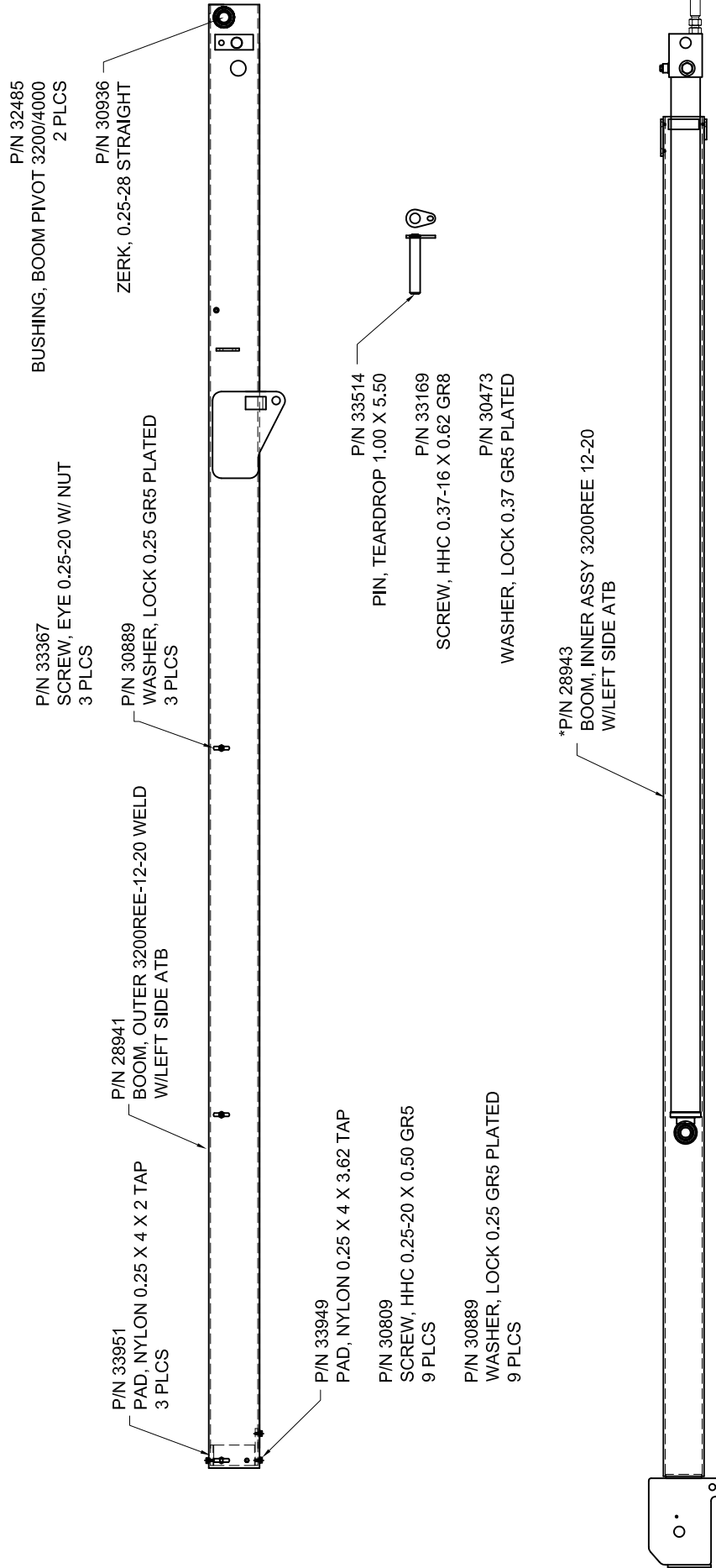

ITEMS WITH * HAVE DETAIL DRAWINGS

DRWN BY: JE
 DATE: 8/6/19

Houston TX
 (713)-688-5533
 www.liftmoore.com



BOOM ASSEMBLY 3200REE-12-20
 W/LEFT SIDE ATB

DRAWING NO.

28942-0

P/N 33950
PAD, NYLON 0.25 X 4 X 3.62 CSK

P/N 33614
SCREW, SOC FH 0.25-20 X 0.50
6 PLCS

P/N 25040
BOOM, INNER 3200REE-12-20 WELD

P/N 33952
PAD, NYLON 0.25 X 3.87 X 2 CSK

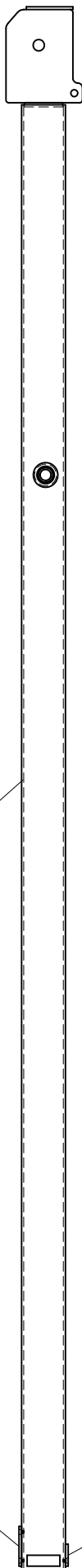

REPLACEMENT PARTS FOR CYLINDER	
DESCRIPTION	PART NUMBER
CHECK VALVE	31591
COUNTERBALANCE VALVE	30851
HOSE, HYD #4 17.25"	32967
ADAPTER, 4MJ-6MO	32400
CYLINDER, 2.5 X 96.0 X 1.25 PE	26486

P/N 17718
CS, 1.00 DIA X 3.50

COUNTER BALANCE VALVE

ADAPTER, 4MJ-6MO
2 PLCS

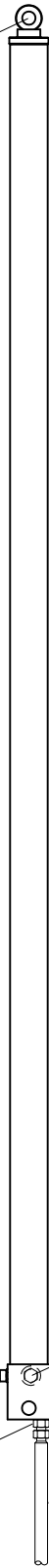

CHECK P.O. VALVE

HOSE, HYD #4 17.25"
2 PLCS

P/N 30692
RING, SNAP 1" INTERNAL CS



Houston TX
(713)-688-5533
www.liftmoore.com

DRWN BY: JE

DATE: 7/31/19

BOOM, INNER ASSY 3200REE 12-20
LEFT SIDE ATB

DRAWING NO.

28943-0

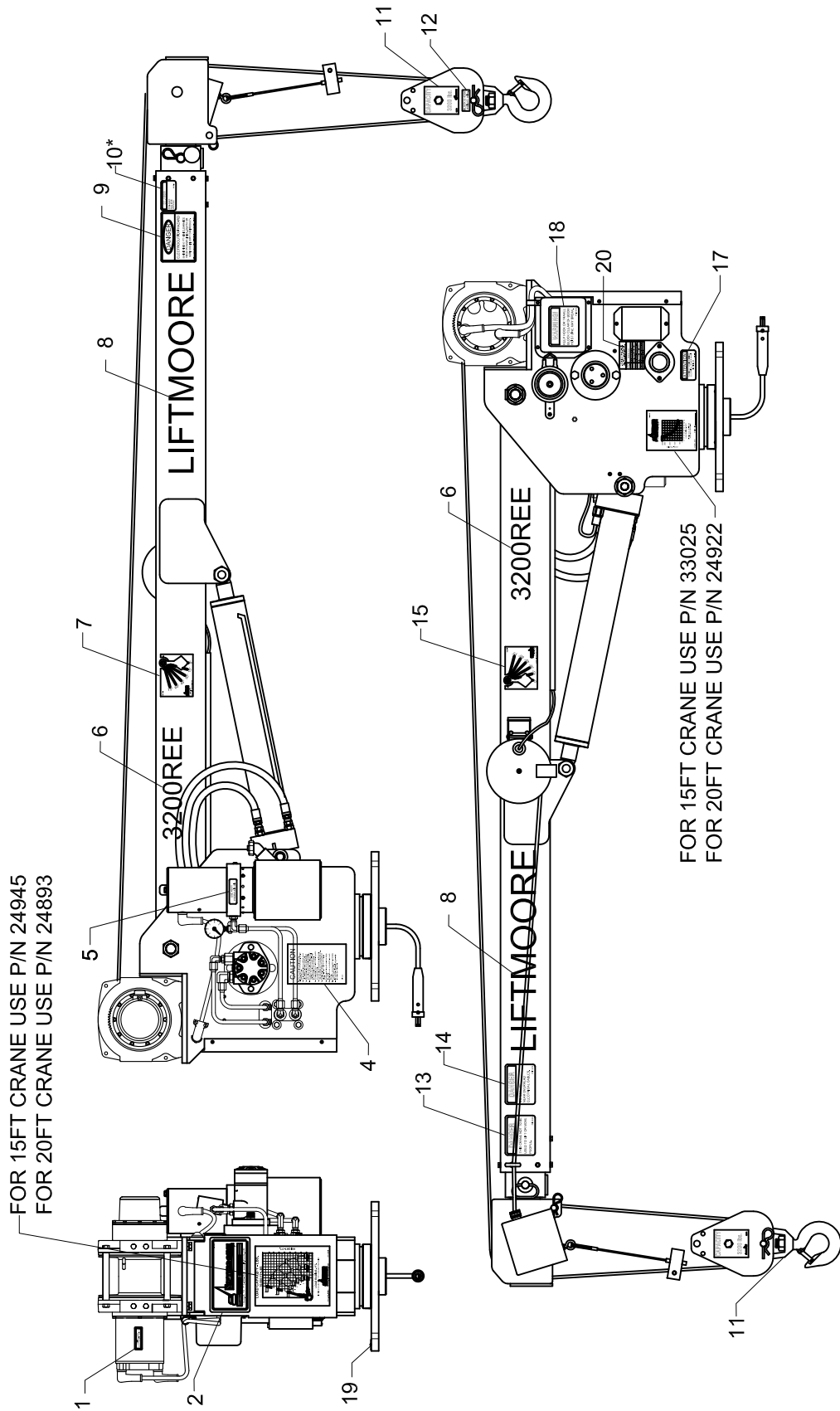

#	PN	DESCRIPTION	QTY	#	PN	DESCRIPTION	QTY	#	PN	DESCRIPTION	QTY
1	32608	DECAL, MOTOR MAGNETS DAMAGE	1	8	33165	DECAL, LIFTMOORE - 2.50"	2	15	22375	DECAL, ANGLE PENDULUM LEFT	1
2	15581	DECAL, LOGO LARGE	1	9	15618	DECAL, DANGER ELECTRIC INJURY	1	16	33025	PLATE, SERIAL 3200/1032	1
3	22382	DECAL, LOAD CAPACITY 10K-7-15	1	10	15612	DECAL, CAUTION PIN MUST BE IN	1	17	15577	DECAL, ATTENTION BATTERY	1
4	16102	DECAL, CAUTION READ MANUAL	1	11	32819	DECAL, TRAVEL BLOCK 3200 LBS.	2	18	15615	DECAL, WARNING TRAVELING BLOCK	1
5	16103	DECAL, USE 46AW HYD. OIL	1	12	22814	DECAL, BLOCK & HOOK WT. 15 lbs	1	19	23389	PLATE, SERIAL NO. MACH	1
6	33020	DECAL, 3200REE HORIZONTAL	2	13	32085	DECAL, LIFTING PERSONNEL	1	20	27910	DECAL, ERROR CODES RELAY BOARD	1
7	22376	DECAL, ANGLE PENDULUM RIGHT	1	14	15579	DECAL, DANGER CABLES	1				

Houston TX
(713)-688-5533
www.liftmoore.com

DECAL, 3200REE W/ ATB ON LEFT SIDE

L. S. ATB, HORN, GAUGE & E-STOP

DRAWING NO. **58346-D**

DRWN BY: JC

DATE: 11/23/09

SERVICE PARTS LIST: DC2000LF HOIST-12V P/N 23872

ITEM REFERENCE		ITEM / KIT No.
1	MOTOR SPLINED 12V DC	WI*84211
2	BRAKE ASSEMBLY DC2000	WI*63550
3	CARRIER ASSY, STAGE 1	WI*28430
4	CARRIER ASSY, STAGE 2	WI*28433
5	CARRIER ASSY, STAGE 3	WI*28115
6	COUPLER, MOTOR/BRAKE	WI*32149
7	CPSCR, 10-24 X 2-1/4-HEX SOCKET HEAD-PI	WI*13850
8	CPSCR, SOC, 10-24 X 3/4, GR9 (KB)	WI*5553
9	(MTO) S/P DRUM SUPPORT, GEAR END	WI*85575
10	DRUM, (KB) 2000-MF, 4.25 DIA	WI*31618
11	SVC KIT END HOUSING SUBASSY, CLUTCH PLUG	WI*85583
12	GEAR, SUN, 12 TOOTH, STAGE 1	WI*13874
13	RING GEAR, ARG, 75 TOOTH	WI*25308
14	HOUSING, GASKET	WI*13848
15	SPACER, MOTOR	WI*15271
16	SVC KIT TIE ROD, ALUMN, .625 X 4.92	WI*85579
17	WASHER, TRUST, NYLATRON, CIM	WI*30277
18	WASHER, TRUST, NYLON, MIDRANGE	WI*13826
19	PARTS PACK, DC2000 HOIST	WI*60049
20	BUSHING DRUM NYLATRON	WI*30274
21	SHAFT-DRIVE-HEX 5/16 X 6.85	WI*84346

DRAWING NO.

25046-E

EWH,DTCH ELEC 3200REE W/E-STOP
RELAY BOARD, SAUER DANFOSS VALVES, HORN

DRWN BY: JE
DATE: 7/20/12

Houston TX
(713)-688-5533
www.liftmoore.com



CIRCUIT NUMBER AND DESCRIPTION

COLOR	LENGTH	CONNECTORS	FUNCTION
BLU/BLK	15"	J14-A	HORN
BRN	10"	J14-B	FM GRND
WHT/BLU	18"	J14-C	SOLENOID-1
WHT	11"	J14-E	PWR, SOC
RED	14"	J14-F	ROT CW VALVE
GRN	8"	J14-G	ELEV UP
ORN	8"	J14-H	ELEV DWN
BLU	8"	J14-J	HOIST UP
WHT/BLK	18"	J14-K	SOLENOID-2
RED/BLK	18"	J14-L	ROT CCW VALVE
GRN/BLK	8"	J14-M	EXT OUT
ORN/BLK	14"	J14-N	EXT IN VALVE
BLK	12"	J14-P	HOIST DWN CONT.
GRN	14"	P2-U.2	ELEV UP VALVE
WHT	18"	P12A.9	EXT. OUT VALVE
YEL	18"	P12A.10	ELEV DWN VALVE
PUR	12"	P12A.11	W. UP CONTACTOR
BRN	10"	P12A.1	GRND
GRY	8"	P12A.4	PRESS SW
BLK	8"	P12A.5	ATB
RED	11"	P12A.12	PWR
RED	11"	P6.4	P2-ATB.1
RED	11"	P6.5	P2-PS.1
YEL	N/A	P6.1	MAIN PWR
N/A	N/A	P6.2	N/A
BRN	20"	P12B.2	ROT CCW VALVE GND
BRN	16"	P12B.3	ROT CW VALVE GND
BRN	20"	P12B.4	EXT OUT VALVE GND
BRN	16"	P12B.6	ELEV UP VALVE GND
BRN	16"	P12B.5	EXT IN VALVE GND
BRN	20"	P12B.7	ELEV DWN VALVE GND
BRN	17"	P12B.10	HORN GROUND
BRN	10"	P12B.1	MAIN GROUND

NOTE A:
FOR J-14
INSTALL 16GA. WHT PLUGS AT PIN LOCATIONS: A & D. **NOTE C:**
FOR P12B-BLACK
INSTALL 16GA. WHITE PLUGS AT PIN LOCATIONS: 11 & 12.

NOTE B:
FOR P12A-GRY
INSTALL 20GA. RED PLUGS AT PIN LOCATIONS: 2 & 3.

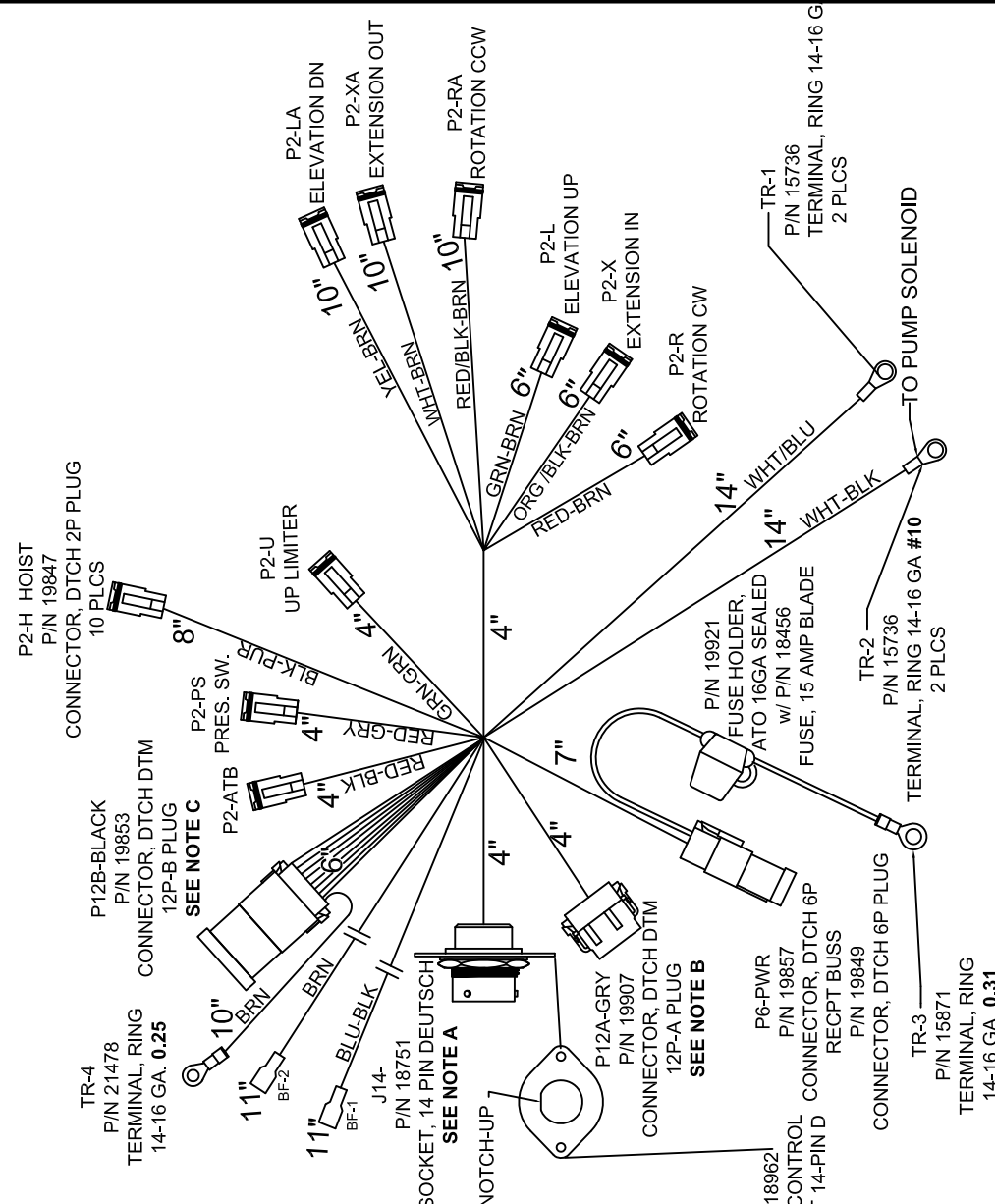

SEE NOTE C

SEE NOTE A

SEE NOTE B

LIFTMOORE LIMITED WARRANTY

Parts and Structural

Liftmoore, Inc. warrants each LIFTMOORE crane to be free from defects in materials and workmanship for twelve (12) months from the date of delivery to the original customer. Under the terms of this warranty the crane structural components manufactured by LIFTMOORE, Inc. are warranted for thirty-six (36) months from the date of delivery to the original customer. LIFTMOORE, Inc. will repair or replace, as its sole discretion, any equipment or part that is returned f.o.b. to LIFTMOORE, Inc.'s plant at 7810 Pinemont Drive, Houston, Texas 77040, or to one of its authorized dealers, and is found by LIFTMOORE, Inc. or its authorized dealer to have been defective at the time of original delivery.

The foregoing warranty is the exclusive warranty made by LIFTMOORE, Inc. with respect to its cranes and is in lieu of all other warranties. ANY AND ALL OTHER WARRANTIES, EXPRESS OR IMPLIED, INCLUDING ANY WARRANTY OF MERCHANTABILITY OR FITNESS OF ANY CRANE FOR A PARTICULAR PURPOSE OR OPERATION, ARE HERBY EXPRESSLY DISCLAIMED.

The foregoing warranty applies only to LIFTMOORE cranes under normal use and service and does not apply in the event of damage caused by repair or alteration or damage during shipment, accident, negligence, overloading, or misuse, including operator's failure to follow any of the instructions issued with the crane.

This warranty is limited to the original purchaser and is not assignable. In order to submit a claim, the original purchaser must provide a copy of the original invoice for the crane in question within twelve (12) months following the delivery date and within 30 days from the date of repair.

The warranty applies only when the LIFTMOORE crane is used for commercial purposes and does not cover any purchase for use for personal, family or household purposes.

LIMITATION OF LIABILITY: LIFTMOORE, Inc.'s liability for any losses or damages resulting from any cause whatsoever, including LIFTMOORE, Inc.'s NEGLIGENCE or from a defective crane irrespective of whether such defects are discoverable or latent, shall in no event exceed the purchase price of the crane to which losses or damages are claimed, or at the election of LIFTMOORE, Inc., the repair or replacement of the defective crane.

In no event shall LIFTMOORE, Inc. be liable for any special, incidental, or consequential damages, including commercial losses or costs of any kind sustained by purchaser or any other person or for any damages for which purchaser may be liable to other persons by reason of any defect in any LIFTMOORE crane or any part thereof.

LIFTMOORE, Inc. reserves the right to make changes in design or construction of its cranes at any time without obligating itself to make such changes on cranes previously manufactured.

No agent, employee, or representative of LIFTMOORE, Inc. has authority to amend or modify the foregoing warranty or to bind LIFTMOORE, Inc. by any other warranty, guaranty, or assumption of liability.

In the event any provision of this warranty is for any reason held ineffective, the remaining provisions shall remain in full force and effect.

Some states do not allow limitations on how long an implied warranty lasts or the exclusion or limitation of incidental or consequential damages, so the above limitations and exclusions may not apply to you. This warranty gives you specific legal rights, and you may also have other legal rights that vary from state to state.

