

TABLE OF CONTENTS
 USERS MANUAL 28606
 MANUAL, CRANE 3660FP-16 SPECIAL
 W/O WINCH, CROWN PLATE, ROPE

SECTION I
GENERAL OPERATION, INSPECTION, AND MAINTENANCE

CRANE SAFETY RULES.....	F1122-B.....	1-1
INTRODUCTION	F1111-D.....	1-3
OPERATING RESTRICTIONS	F1637-A	1-4
OPERATING PRACTICES	F1637-A	1-4
INSPECTION AND MAINTENANCE.....	F1113-D	1-7
MONTHLY INSPECTION REPORT	F1123-B.....	1-9
ANNUAL INSPECTION REPORT.....	F1507-0	1-10
STANDARD HAND SIGNALS FOR CRANE OPERATION.....	F2409-0	1-13

SECTION II
CRANE SYSTEMS AND TROUBLESHOOTING

PENDANT CONTROL SYSTEM.....	F1753-0	2-1
SAFETY SYSTEM.....	F1769-0	2-2
PROPORTIONAL HYDRAULIC SYSTEM.....	F1668-0	2-3
BASIC TROUBLESHOOTING	F1117-F	2-5
TROUBLESHOOTING SAFETY SYSTEM	F1254-A	2-6
DEUSTCH CONNECTORS & PINS	F2435-0	2-8

SECTION III
CRANE SPECIFICATIONS

LIFTING CAPACITIES	F1118-D	3-1
POWER FUNCTIONS AND SPEEDS.....	F1118-D	3-1
BOLT AND LUBRICATION SPECS	F1118-D	3-2
BOLT AND LUBRICATION POINTS.....	F1118-D	3-3

SECTION IV
PARTS

BOX PARTS LIST	F2515-0	4-1
CRANE ASSEMBLY	DWG.28605-0	4-2
PENDANT CONTROL	DWG.24694-F	4-3
MEGA KTFM WIRELESS CONTROLS	DWG.23693-B.....	4-4
BOOM-BODY ASSEMBLY.....	DWG.26748-0	4-5
ELEVATION CYLINDER ASSEMBLY	DWG.20630-A	4-6
BODY ASSEMBLY	DWG.25165-D	4-7
MANIFOLD ASSEMBLY	DWG.26053-A	4-8
MANIFOLD PRE-ASSEMBLY	DWG.24993-A	4-9
BASE-HOUSING ASSEMBLY.....	DWG.23430-F.....	4-10
ROTATION SPEED REDUCER	DWG.20232-0	4-11
ELECTRIC SWIVEL	DWG.28161-0	4-12



TABLE OF CONTENTS
USERS MANUAL 28606
MANUAL, CRANE 3660FP-16 SPECIAL
W/O WINCH, CROWN PLATE, ROPE

BOOM ASSEMBLY SPECIAL.....	DWG.26747-0	4-13
BOOM OUTER ASSEMBLY SPECIAL.....	DWG.26744-0	4-14
ELECTRICAL WIRING HARNESS.....	DWG.25125-A	4-15
ELECTRICAL SCHEMATIC DTCH.....	DWG.50890-0	4-16
HYDRAULIC SCHEMATIC.....	DWG.50801-C.....	4-17
DECAL DIAGRAM	DWG.58329-B.....	4-18
RELAY BOARD ASSEMBLY	DWG.22569-C.....	4-19
WARRANTY	F1442-A	



F2516-0
10/6/17

HOUSTON, TEXAS
FAX: (800) 824-5559 (USA & Canada)
FAX: (713) 688-6324
PHONE: (713) 688-5533
www.liftmoore.com

CRANE SAFETY RULES

CAUTION!

1. READ AND UNDERSTAND OPERATOR'S MANUAL.
2. INSPECT VEHICLE AND CRANE, INCLUDING ITS OPERATION BEFORE DAILY USE.
3. USE THIS EQUIPMENT ONLY ON SOLID LEVEL GROUND WITH OUTRIGGERS OR JACKSTANDS PROPERLY SET.
4. BEFORE OPERATING THE CRANE REFER TO MAXIMUM LOAD CHART ON CRANE FOR OPERATING LOAD LIMITS.
5. BE SURE LOAD BEING LIFTED IS WITHIN SAFE WINCH CAPACITY AS WELL AS SAFE CRANE CAPACITY. MULTI-PART LINE OPERATION IS REQUIRED WHEN SINGLE LINE LOAD CAPACITY OF WINCH IS EXCEEDED.
6. DO NOT OPERATE, WALK, OR STAND UNDER THE BOOM OR ANY SUSPENDED LOAD.
7. ALWAYS PAY OUT LOAD LINE BEFORE EXTENDING BOOM. WIRE ROPE DAMAGE AND / OR BREAKAGE MAY OCCUR.
8. BOOM MUST BE IN ITS REST BEFORE MOVING VEHICLE.
9. BOOM TIP MUST BE DIRECTLY OVER THE LOAD BEFORE ANY LIFTING IS STARTED. DO NOT DRAG LOADS WITH THIS CRANE.
10. MAINTAIN THIS CRANE AS REQUIRED IN THE OWNER'S MANUAL.
11. DO NOT ALLOW PERSONNEL TO RIDE ON THE LOAD LINE, LOAD, OR BOOM OF THIS CRANE.
12. IT IS UNLAWFUL TO OPERATE THIS EQUIPMENT WITHIN TEN FEET OF HIGH VOLTAGE LINE



THIS PAGE INTENTIONALLY LEFT BLANK



F1122-B
05/12/08

HOUSTON, TEXAS
FAX: (800) 824-5559 (USA & Canada)
FAX: (713) 688-6324
PHONE: (713) 688-5533
www.liftmore.com

INTRODUCTION

This crane is a powerful machine designed to lift and move heavy loads. There are many hazards associated with these operations. Liftmoore has designed this crane to be as safe as possible but -

IT IS THE OPERATOR'S RESPONSIBILITY TO PREVENT ACCIDENTS!

This takes pre-planning, attention, and knowledge of basic principles and rules. Even if you have used similar cranes, reading this manual in its entirety will help prevent damage, injury, or even loss of life; benefits well worth the short amount of time it takes to read these pages.

REGULATORY AUTHORITY

Use of this crane is governed by OSHA 29 CFR 1910.180 and may be governed by other federal, state, or local regulations.

IT IS THE OPERATOR'S RESPONSIBILITY TO UNDERSTAND AND COMPLY WITH ALL APPLICABLE REGULATIONS GOVERNING THE OPERATION, INSPECTION, AND MAINTENANCE OF THIS CRANE.

Personnel should be trained, tested, and certified, as recommended by OSHA and ANSI standards, before operating this crane.

USING THIS MANUAL

This manual assumes that the crane is mounted on a typical service body type or similar truck, which is powered by the vehicle electrical or hydraulic system, and is controlled by either the standard pendant control or FM radio control sold by Liftmoore, Inc.

This manual is supplied to provide basic guidelines for the safe use, routine maintenance, and general inspections of this crane.

This manual is supplied to provide basic guidelines for the safe use, routine maintenance, and general inspections of this crane.

Laws, regulations, standards, or policies may be more restrictive than this manual. If a conflict exists for any limit or condition, the safest or most prohibitive shall be used. Under no circumstances shall the load, moment, or stability ratings be exceeded.

Pay particular attention to the following:

WARNING! – Draws attention to hazards, conditions, or procedures that if not observed could result in injury or death.

CAUTION! – Draws attention to hazards, conditions, or procedures that if not observed could result in damage to the crane, load, or other equipment. Equipment failure could in turn lead to injury or death.

NOTE! – Draws attention to conditions or procedures that are essential to emphasize.

For questions, interpretations, or to report errors, please contact Liftmoore, Inc, Engineering Dept.



OPERATING PRACTICES

OPERATING RESTRICTIONS

DUTY CYCLE

For Electric Cranes the duty cycle time should be limited to 10%. This is limited by heat buildup in the motors and declining charge in the batteries. (Installing extra batteries near the crane helps keep the voltage at maximum.)

PERSONNEL

LIFTING OR MOVING OF PERSONNEL IS STRICTLY PROHIBITED! This crane was neither designed nor intended to lift personnel. Under no circumstances should anyone be allowed to ride on the crane, line, or load. All non-essential personnel must be kept away when using the crane. The load must never be moved over people, nor must anyone be allowed to pass or stand under a suspended load.

ELECTRICAL LINES

Consult ANSI B30.5 for operating procedures, minimum safe distances, and prohibited zones when working around electrical lines or poles.

When operating near electrical power lines, the crane must be positioned so that the distance from the crane to the lines or poles is equal to or greater than the length of the fully extended boom plus the minimum safe distance required.

All parts of the crane, line, and load must be kept a minimum safe distance from electrical power lines and poles. This distance is 10 feet for electrical lines carrying 50kV or less.

UNDER NO CIRCUMSTANCES SHOULD A CRANE BE OPERATED UNDER ELECTRICAL POWER LINES.

SETUP

POSITION The vehicle must be positioned so that the load is kept as close to the crane base as possible to reduce the moment on the crane. Consideration must be given to starting and ending position as well as firmness and slope of the ground and any obstructions.

OUTRIGGERS The outriggers or jack-stands must be firmly set and the vehicle as level as possible. This will reduce the stresses on the rotation drive and keep the load off the vehicle's suspension. Keep in mind that the weight on the vehicle will shift as the crane and load is rotated.

MANUAL BOOM EXTENSION If the manual extension part of the boom is needed, it must be extended and the boom pin placed in the required position. Insert the pin and replace the pin's hairpin keeper before attempting to lift any load.

LOAD LIMIT The operator must understand the crane load chart. The operator must ensure that the load is within the load limits over the entire range which it will be moved. Be sure to include the weight of any lifting devices including the travel block.

The load limit chart is attached to the side of the crane to aid the operator.

The boom angle indicator and chart aids the operator in determining the load capacity at various boom angles and extensions. It also gives the load limit at that configuration.

STABILITY A stability chart must be posted near the crane. The operator must understand the stability chart. The crane may be de-rated over some areas of its operating radius.



TRAVEL BLOCK The operator must determine if the load is within the single line compatibility of the winch or if a multi-part line configuration is needed.

REEVING Ensure the proper routing of the rope through the sheaves and travel block. The rope must lie in the sheave groove and must not rub against any metal objects.

Ensure the rope is correctly wound on the winch drum. The crane assembly drawing will indicate if the rope must be wound over the top or bottom of the drum. The rope must never contact any part of the winch mounting.

WARNING!

If the winch winding direction is reversed the brake will not work and the load will fall.

CRANE POWER

Before operating the crane turn ON power switch (Normally located under the crane) and twist to release E-Stop switch.

Push in E-Stop switch to turn OFF when the crane is no longer in use. Twist to release, hydraulic will not function if E-Stop button is pushed in.

ATTACHING THE LOAD

POSITION The boom tip must be moved over the load before lifting so that it will be lifted straight up.

CAUTION!

Never drag a load with the crane. Dragging a load puts very high stresses on the crane for which it was not designed.

ROPE Check the rope condition to ensure it is not frayed or damaged. Ensure that the rope is not kinked and that it does not contact any sharp edges or make any sharp bends.

If using double line configuration, ensure that the lines are not twisted.

CAUTION!

Never wrap the hoist rope around the load! Serious damage to the rope WILL occur.

HOOK Always make sure the load is applied to the throat of the hook. Never use a bent hook.

CAUTION!

Always lift with the throat of the hook. Never lift with the load applied to the tip of the hook. Doing so will bend the hook.

SLINGS If the load does not have a lifting eye, use a nylon, chain, or other type of sling designed for lifting and rated for loads greater than that being lifted.

BALANCE Ensure the load will be secure and balanced when lifted. Ensure that the load cannot shift in the sling and that the sling cannot slide across the hook should the load become unbalanced.



LIFTING THE LOAD

Before lifting, ensure that the load is free from all mountings and is no way attached or stuck to anything.

Ensure that at least five full wraps remain on the winch drum at all times.

Test the winch brake by lifting the load a few inches and ensuring that it does not slip.

HOLDING THE LOAD

The operator must keep the load in sight at all times once it is lifted.

The operator must never leave the controls once the load is lifted.

The operator must ensure that no one is allowed to pass or stand under a suspended load.

CAUTION!

Never move the vehicle with a suspended load. Doing so will put dynamic loads on the crane for which it was not designed.

MOVING THE LOAD

Before moving the load, make sure the path is free of any obstructions or people.

Avoid sudden accelerations or stops. Speeds must be kept to a minimum, especially rotation, to keep the load from swinging.

Avoid sudden reversing of direction. Do not reverse direction while the load is still moving.

Make sure that no part of the crane, boom, or load makes contact with any obstruction or comes within a minimum of ten feet from any electrical line.

TRANSIT

While in transit, the crane must be stowed, preferably in a boom rest. The crane must be prevented from rotating and the hook prevented from swinging.



INSPECTION AND MAINTENANCE

OSHA and ANSI require frequent and periodic inspections. Records of these inspections must be kept readily available. Liftmoore requires periodic maintenance to ensure proper operation and prolonged life of the crane.

INSPECTION

DAILY INSPECTION

OSHA 29CFR 1910.180 (d)(2)(i) requires the following be checked daily prior to use:

- All control mechanisms for maladjustment interfering with proper operation as well as for excessive wear of components and contamination by lubricants or other foreign matter.
- All safety devices for malfunction. This should include the anti-two block and pressure switch.
- Deterioration or leakage in air or hydraulic systems.
- Crane hooks with deformations or cracks. For hooks with cracks or having more than 15 percent in excess of normal throat opening or more than 10 deg. twist from the plane of the unbent hook.
- Electrical apparatus for malfunctioning, signs of excessive deterioration, dirt, and moisture accumulation. This should include the battery terminals, master disconnect switch, electrical swivel
- The wire rope shall be replaced if any of the following conditions are noted:
 - Kinking, crushing, bird-caging, or other damage
 - Reductions from nominal diameter of more than one-sixty-fourth inch for diameters up to and including five-sixteenths inch, one-thirty-second inch for diameters three-eighths inch to and including one-half inch.
 - Thimble is not in place or is damaged
 - Any evidence of heat damage
 - Six or more randomly distributed broken wires in 1 lay
 - Three or more broken wires in 1 strand in 1 lay

MONTHLY INSPECTION

A thorough inspection of all ropes in use shall be made at least once a month and a certification record which includes the date of inspection, the signature of the person who performed the inspection and an identifier for the ropes shall be prepared and kept on file where readily available. All inspections shall be performed by an appointed or authorized person. Any deterioration, resulting in appreciable loss of original strength shall be carefully observed and determination made as to whether further use of the rope would constitute a safety hazard. Some of the conditions that could result in an appreciable loss of strength are the following:

- Reduction of rope diameter below nominal diameter due to loss of core support, internal or external corrosion, or wear of outside wires.
- A number of broken outside wires and the degree of distribution of concentration of such broken wires.



- Worn outside wires.
- Corroded or broken wires at end connections.
- Corroded, cracked, bent, worn, or improperly applied end connections.
- Severe kinking, crushing, cutting, or unstranding.

PERIODIC INSPECTION

An Annual Inspection Form is included in this manual. OSHA 29CFR 1910.180 (d)(2)ii) requires periodic inspections of this crane. Liftmoore recommends an annual inspection using the included form.

MAINTENANCE PRECAUTIONS

The crane should be maintained monthly for safety reasons and to reduce stress on the crane.

WARNING!

Never perform any maintenance while the crane has any type of load on it. Use the manual operation procedure to lower the load if necessary.

WARNING!

Hydraulic cylinders may have high pressure stored in them even after hydraulic power is removed.

The counterbalance and pilot operated check valve in the cylinder will always hold some pressure in the cylinder. Slightly extending the cylinder then retracting a small amount will relieve most of the pressure in the cylinder. **DO NOT DEADHEAD THE CYLINDER!** This will store the maximum amount of pressure in the cylinder. Care should be taken when either valve is removed from the cylinder as some pressure will still remain.

After any maintenance has been performed the crane shall not be operated until all guards have been reinstalled, all safety

devices reactivated, and maintenance equipment removed.

LUBRICATION Refer to the crane specification section for the periodic maintenance schedule and type of lubrication required.

BOLTS Bolts may loosen over time due to vibration; therefore they should be checked periodically. If bolts need to be replaced, make sure they are replaced with bolts of equal or greater strength. Check the periodic maintenance schedule (Crane Specification Section) for bolt specification and torque.

NOTE!

Sheave and boom and cylinder pivot bolts are not standard bolts. The shank and thread length of these bolts have been modified so that they do not pivot on the threads. Consult the parts section of this manual for part numbers of these bolts.

OTHER MAINTENANCE

Refer to parts drawings for any specific maintenance or adjustment procedures such as hydraulic winch brake, rotation drive gear set adjustment, Ect.



MONTHLY INSPECTION REPORT

Crane Model No. _____ Serial Number _____

Are Boom Hitch Pins and Keepers in place?	Yes _____	No _____
Wire Line Hook with Safety Latch Working?	Yes _____	No _____
Is Hook OK, (Not bent)?	Yes _____	No _____
Is Thimble on Wire Rope OK?	Yes _____	No _____
Is Traveling Block in use?	Yes _____	No _____
Is Wire Rope OK, not kinked or frayed?	Yes _____	No _____
Are all Boom Sections straight?	Yes _____	No _____
Are Sheave Bolts in place and tight?	Yes _____	No _____
Do all Sheaves rotate easily?	Yes _____	No _____
Are Mounting Bolts tight?	Yes _____	No _____
Is Anti Two-Block functioning properly?	Yes _____	No _____
Is Boom Angle Indicator in place and functioning and is Chart legible?	Yes _____	No _____
Are Cylinder Mounting Bolts secure?	Yes _____	No _____
Are Winch Mounting Bolts tight?	Yes _____	No _____
When stopped does winch drift less than 1.0 Inches?	Yes _____	No _____
Is Load Chart in place and easily read?	Yes _____	No _____
Are functions on Pendant operating correctly?	Yes _____	No _____
Is Hydraulic Reservoir full?	Yes _____	No _____
Is Outrigger straight and functioning?	Yes _____	No _____

Any items checked 'No' must be repaired before using this crane.



ANNUAL CRANE CERTIFICATION (29CFR1910.180)

OWNER _____

MODEL NUMBER _____ SERIAL NUMBER _____

DATE _____

Check the following:

___ Crane Mounting Bolts (Torque)

___ Winch mounting Bolts (Torque)

___ Boom mounting bolts

___ Cylinder mounting bolts

___ Cracks on boom (Check when extended)

___ Extension Pads not worn excessively

___ Cracks on housing

___ Weld cracks on boom

___ Weld cracks on housing

___ Boom swing approximately one inch or less at boom tip when retracted

___ Hydraulic leaks

___ Hoses not chafed or cracked

Sheaves not cracked

___ Boom Tip

___ Traveling Block

___ Sheaves not worn excessively

___ Boom Tip

___ Traveling Block

___ Sheaves rotate freely

___ Boom Tip

___ Traveling Block

- ___ *Load Chart in place and legible*
- ___ *Boom angle chart in place and legible*
- ___ *Labels in place (See manufacturer's chart)*
- ___ *Crane Hook Throat Opening within 15% of standard*
- ___ *Crane Hook not bent more than 10 degrees from plane*
- ___ *Hook safety latch operating properly*
- ___ *Booms pin(s) and Keeper(s) in place (Manual Extension Section)*
- ___ *Wire Rope removed if the following occurs:*

Six randomly distributed broken wires in one lay or three broken wires in one strand in one lay.

Wear of one-third the original diameter of outside individual wires.

Kinking, crushing, bird-caging or any other damage.

Evidence of heat damage.

Reduction from nominal diameter of more than one sixty-fourth inch for diameters to five-sixteenths diameter and one-thirty-second inch for diameters three-eighths to one-half inch.

- ___ *Wire Line installed as manufacturer requires.*
- ___ *Protective covers in place*
- ___ *Grease crane as required*

Check fluid level

- ___ *Winch*
- ___ *Gearbox*
- ___ *Reservoir*

Control system for proper operation

___ *Winch Up and Down*

___ *Boom Up and Down*

___ *Boom In and Out*

___ *Rotation CW and CCW*

Anti Two-Block (Required on Power Extendible Cranes) interrupts:

___ *Boom Down*

___ *Boom Out*

___ *Winch Up*

___ *Boom Up stopped by Up Limit Switch*

___ *Outrigger or jackstand operable*

___ *Outrigger crushing decal in place*

___ *Outrigger and Jackstand operates properly*

___ *Boom rest in place and used*

___ *Load Sensor trips when overloaded*

___ *Winch Down does not overrun when stopped*

___ *Crane stability chart in place and visible.*

I certify that I have performed the above tests and that any deficiencies were corrected and now comply as above.

Signed _____



Print Name _____

Company _____





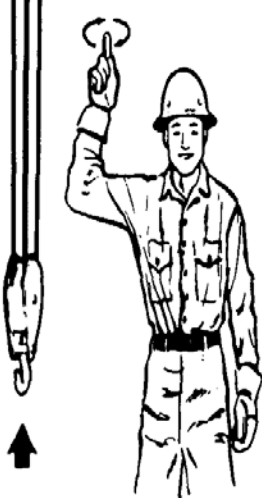
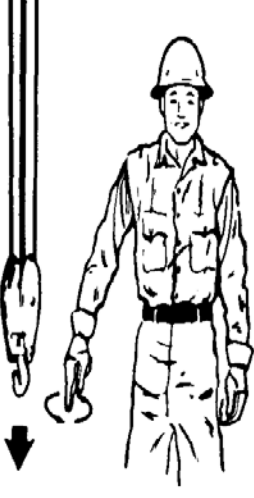

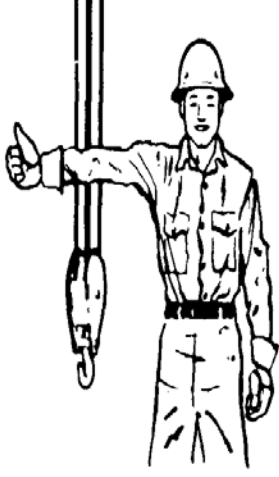
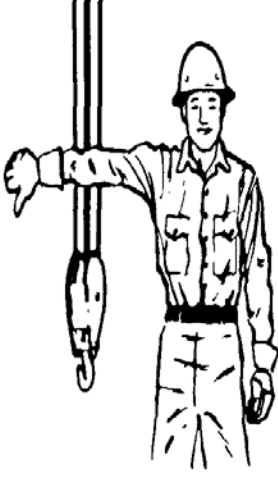

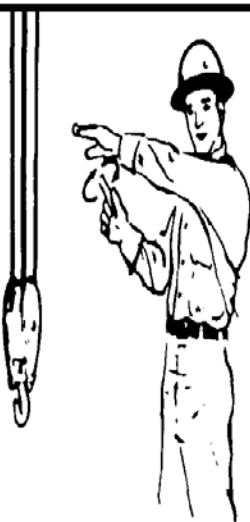
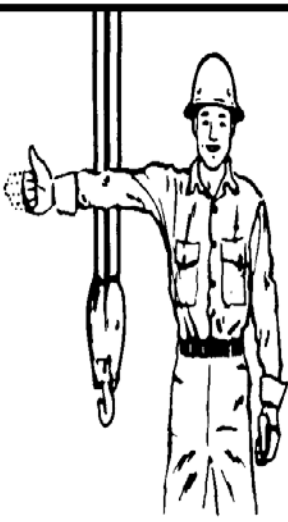
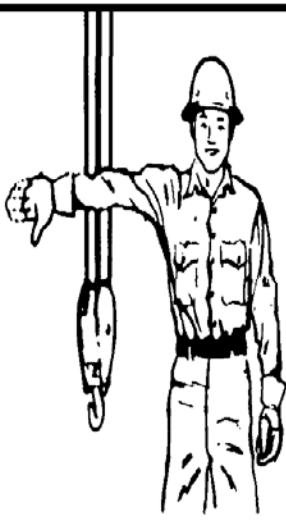
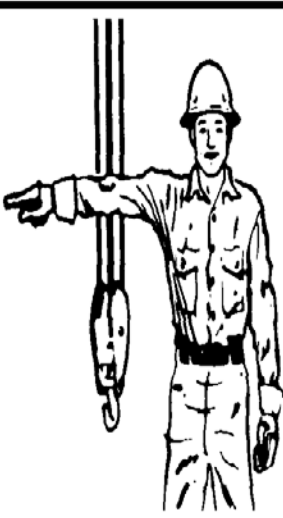
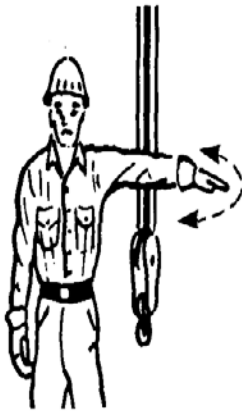
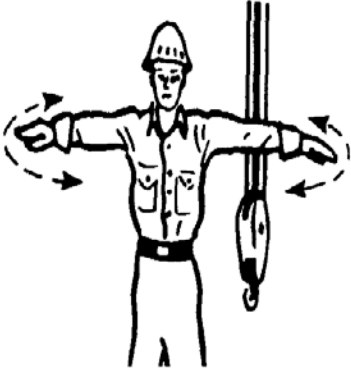
Address _____

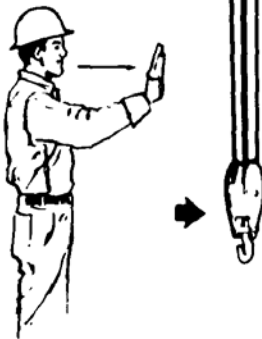
City _____ *State* _____

STANDARD HAND SIGNALS FOR CONTROLLING CRANE OPERATIONS

 <p>HOIST. With forearm vertical, forefinger pointing up, move hand in small horizontal circle.</p>	 <p>LOWER. With arm extended downward, forefinger pointing down, move hand in small horizontal circle.</p>	 <p>USE MAIN HOIST. Tap fist on head; then use regular signals.</p>
 <p>USE WHIPLINE (Auxiliary Hoist). Tap elbow with one hand; then use regular signals.</p>	 <p>RAISE BOOM. Arm extended, fingers closed, thumb pointing upward.</p>	 <p>LOWER BOOM. Arm extended, fingers closed, thumb pointing downward.</p>

 <p data-bbox="256 751 597 934">MOVE SLOWLY. Use one hand to give any motion signal and place other hand motionless in front of hand giving the motion signal. (Hoist slowly shown as example.)</p>	 <p data-bbox="630 751 971 898">RAISE THE BOOM AND LOWER THE LOAD. With arm extended, thumb pointing up, flex fingers in and out as long as load movement is desired.</p>	 <p data-bbox="1003 751 1344 934">LOWER THE BOOM AND RAISE THE LOAD. With arm extended, thumb pointing down, flex fingers in and out as long as load movement is desired.</p>
 <p data-bbox="264 1497 597 1570">SWING. Arm extended, point with finger in direction of swing of boom.</p>	 <p data-bbox="638 1497 971 1612">STOP. Arm extended, palm down, move arm back and forth horizontally.</p>	 <p data-bbox="995 1497 1328 1612">EMERGENCY STOP. Both arms extended, palms down, move arms back and forth horizontally.</p>

 <p>TRAVEL. Arm extended forward, hand open and slightly raised, make pushing motion in direction of travel.</p>	 <p>DOG EVERYTHING. Clasp hands in front of body.</p>	 <p>TRAVEL (Both Tracks). Use both fists in front of body, making a circular motion about each other, indicating direction of travel, forward or backward. (For land cranes only.)</p>
 <p>TRAVEL (One Track) Lock the track on side indicated by raised fist. Travel opposite track in direction indicated by circular motion of other fist, rotated vertically in front of body. (For land cranes only.)</p>	 <p>EXTEND BOOM (Telescoping Booms). Both fists in front of body with thumbs pointing outward.</p>	 <p>RETRACT BOOM (Telescoping Booms). Both fists in front of body with thumbs pointing toward each other.</p>
 <p>EXTEND BOOM (Telescoping Boom). One Hand Signal. One fist in front of chest with thumb tapping chest.</p>		 <p>RETRACT BOOM (Telescoping Boom). One Hand Signal. One fist in front of chest, thumb pointing outward and heel of fist tapping chest.</p>

THIS PAGE INTENTIONALLY LEFT BLANK



F2409-0
4/11/16

HOUSTON, TEXAS
FAX: (800) 824-5559 (USA & Canada)
FAX: (713) 688-6324
PHONE: (713) 688-5533
www.liftmoore.com

ON/OFF PENDANT CONTROL SYSTEM

Liftmoore cranes are electrically controlled using the hand-held pendant, which works in conjunction with the crane control module to operate powered functions.

PENDANT

All user inputs are facilitated by the remote pendant control. The pendant consists of pistol grip housing, wire, and control plug. The control plug mates with the crane control socket.

CRANE CONTROL MODULE

For ON/OFF (non-proportional) cranes the crane control module contains only the limiting system control board. It is a single printed circuit board enclosed in a rugged, sealed housing. Status LEDs are located on the circuit board to aid in troubleshooting.

The limiting system control is part of the safety system. Refer to that section for more information.

E-STOP

This feature is located on the pendant control box. The E-Stop button controls a relay in the crane's electrical power supply line. When pressed, electrical power is disconnected. To restore power you must turn button clock-wise until it pops back up

OPERATION

Plug the pendant into the crane control socket. Ensure all pins are straight and free of dirt, moisture, and corrosion. Turn the locking ring approximately 1/3 turn until it clicks into the locked position.

Select the function switch and direction as indicated on the label for the desired operation.

CARE AND MAINTENANCE

The pendant control is designed to be as rugged and maintenance free as possible; however, care should be used in handling and storage as it is expensive to replace.

Follow these simple practices:

- Keep the pendant out of the weather
- When not in use, store the pendant inside the vehicle or body compartment
- Do not wrap the wire too tightly as internal damage to the wires may result
- Do not place sharp or heavy object on the cord

NOTE!

The pendant is designed to be weatherproof not waterproof. It may be used in inclement weather, but if left outside or where water can puddle, water can seep inside.

Maintenance should be limited to routine inspection of the plug, wire, and fasteners.



SAFETY SYSTEM

The safety system is designed to help prevent damage to the crane that would be caused by overload or two-blocking. The system consists of a load sensor, anti-two block device (optional on smaller, electric cranes), and limiting system control board.

When the applicable switch detects an overloading or two-block condition, the limiting system will prevent activation of winch up, and extend out since these directions would cause damage. Winch down, boom down, boom up, extend in, and power rotation will still function so that the crane can be moved to a safe configuration.

CAUTION!

Never de-activate or override safety functions. Doing so can result in serious damage to the crane and possibly injury or death.

LOAD SENSOR

A pressure activated switch in the elevation cylinder acts as a load sensor. This switch is normally closed and opens at the preset pressure corresponding to the load rating of the crane.

CAUTION!

The load sensor will not function when the elevation cylinder is fully retracted and is inaccurate when the boom is below horizontal.

CAUTION!

The operator must never rely strictly on the load sensor to determine overload conditions. The load and load limits must always be known and adhered to.

ANTI-TWO BLOCK

The anti-two block device (optional on smaller electric cranes), mounted on the boom crown plate, consists of a normally open switch actuated by a lever. A weight is attached to the lever and holds the switch

closed. If the weight is lifted by the hook or travel block the switch opens.

The power and signal wires are wired through the cord reel, which is in turn wired to the ATB switch.

LIMITING SYSTEM CONTROL

Two systems are included to limit crane overloads and wire rope breakage. When a crane overload occurs, the load sensor will stop winch up, extension out and boom down. To prevent breaking the wire rope, the Anti Two-Block device stops winch up and extension out when either is engaged.

The capacity of boom up is limited by the pressure setting of the relief valve in the manifold.

There is a one second delay before the deactivation of boom down when the load sensor is tripped to prevent false readings caused by pressure spikes.

MISCELLANEOUS

UP LIMIT SWITCH

The up limit switch prevents the elevation cylinder from reaching full extension. If the elevation cylinder were to "dead-head", the resulting pressure would activate the load sensor, preventing boom down. The boom would then have to be lowered using the manual operation buttons on the solenoid valves.

CIRCUIT BREAKER, FUSE

For electric cranes a 150 Amp circuit breaker is supplied with the crane. It should be installed as close to the battery as possible. For hydraulic cranes a 10 Amp blade type fuse is supplied.

DISCONNECT SWITCH

A power disconnect switch is supplied with the crane. Power to the crane should be turned off whenever not in use. This is to prevent inadvertent or unauthorized use and will help prevent corrosion at electrical connections.



HYDRAULIC SYSTEM

Integrated Hyd Proportional

The hydraulic system consists of the hydraulic swivel, manifold with solenoid valves, cylinders, motors, and tubing and hoses. Hydraulic power is received from an external hydraulic source, typically a PTO driven pump attached to the vehicle transmission. The hydraulic system uses open center valves in series so that multiple functions can be operated simultaneously.

SWIVEL- (NOT USED IN 1032 OR 1640)

The hydraulic swivel is a two-port swivel that allows continuous, unlimited rotation. Refer to drawing for more information.

MANIFOLD

The hydraulic manifold consists of a differential pressure sensing flow control valve, the system relief valve, proportional flow control valve, and 4 way directional control valves.

The Logic valve is a pilot operated pressure compensated flow control cartridge valve. It supplies the required flow to the manifold and returns excess flow to the tank so that pressure drop and heat build up are minimized.

The system relief valve prevents damage that would be caused by excessive pressure in the system. It is a cartridge type valve. Factory setting is 2800PSI.

The proportional valve is an electrically operated flow control valve. It allows the operator to control the flow, and therefore the speed, of the selected functions. The flow output is directly proportional to the electrical input. The valve may be operated manually by depressing the manual operation button on the top of the valve.

Each hydraulically operated function is controlled by a 4 way, 3 position open center solenoid valve. It is electrically operated and spring biased to center. A manual operation button is incorporated in the coil retaining nut.

Each hydraulically operated function is controlled by a 4 way, 3 position open center solenoid valve. It is electrically operated and spring biased to center. A manual operation button is incorporated in the coil retaining nut.

CYLINDERS

Hydraulic cylinders are double acting cylinders with integrally mounted counterbalance valve and pilot operated check valves. Refer to the cylinder drawings for specific information.

All cylinders use a counter-balance load holding cartridge valve on the extend port. This valve performs 3 functions:

- Controls the rate of decent when lowering the load
- Keeps load from falling in the event of sudden loss of system pressure, such as when a hose bursts.
- Acts as a relief valve to prevent damage from induced load or thermal expansion.

It allows free flow to extend then blocks flow until opened by pilot pressure to the retract port or when the relief pressure is reached.

Some cylinders utilize a pilot operated check valve on the retract port to prevent the cylinder from creeping out under no load conditions. This valve allows flow into, but prevents flow from the retract port, thus hydraulically locking the cylinder until opened by pilot pressure to the extend port.

MOTORS

The hydraulic motors used by the rotation drive and hydraulic winch are high torque, low speed constant displacement motor.



MANUAL OPERATION

If electrical problems occur the solenoid valves may be operated manually. Refer to the manifold drawing for function valves and directions.

Directional control valves are manually operated by depressing the boot at the end of the valve. Use a blunt object (e.g. bolt or screwdriver handle) to assist in the operation.

Proportional valves are operated with either a boot or a small screw. Depress the boot or turn the screw slowly while operating a function to determine optimum speed. Turning the screw all the way in will result in rapid crane movement.

If hydraulic power is lost while a load is suspended, the load may be lowered by decreasing the setting on the counterbalance valve. This should only be done in extreme cases. The valve must be reset before the crane is returned to use.

To decrease the setting, loosen the locknut on the valve, then slowly turn the adjustment stem **CLOCKWISE** until the load begins to lower. Count the number of turns so that the valve can be returned to its original setting.

Alternately, a pressure gage must be put on the retract port to adjust the setting so that approx. 1800 PSI is required to lower the boom with no load.

Test the setting by lifting a known load near the moment rating of the crane.



BASIC TROUBLESHOOTING

The following chart gives a quick reference to help identify and correct problems. Refer to the following pages for more detailed information.

PROBLEM	PROBABLE CAUSE	CORRECTIVE ACTION
NO FUNCTIONS WORK	<p>Not receiving electrical power</p> <p>Not receiving hydraulic power</p> <p>Control problem</p>	<p>Check all connections Check all fuses and circuit breakers Check for electrical power at first electrical connection and trace back to crane</p> <p>Check flow from pump Deadhead cylinder and check pressure at pump</p> <p>See control section</p>
<p>FUNCTION NOT WORKING</p> <p style="text-align: center;">winch up, extension out not working</p> <p style="text-align: center;">Boom down, winch down, extension in not working</p> <p style="text-align: center;">Other function not working</p>	<p>No signal from ATB or Load sensor (switch tripped, bad switch, bad wiring or not receiving power)</p> <p>Relay card malfunction</p> <p>Not receiving enough pressure</p> <p>Faulty wiring</p> <p>Valve coils bad</p>	<p>Check input signal to relay board if no signal, trace back to switch</p> <p>Check LEDs on board for error codes and outputs</p> <p>Deadhead cylinder and check pressure at pump Check differential pressure valve for contamination Check relief valve for proper setting and possible contamination</p> <p>Check all wiring for breaks or shorts Check all ground wires for good connection</p> <p>Check coil resistance</p>
<p>ALL FUNCTIONS SLOW</p> <p>* These items only apply to cranes with proportional control systems.</p>	<p>Not receiving enough flow</p> <p>Low battery voltage Check with engine running</p> <p>* Proportional valve problem</p> <p>* Control problem</p>	<p>Check fluid levels Check all filters and any other restrictions</p> <p>Charge battery (BATTERY MAY BE BAD)</p> <p>Try manual operation of proportional valve</p> <p>Check voltage at valve for approx. at min and max(see troubleshooting form for specific valves)</p> <p>See control section</p>



TROUBLESHOOTING SAFETY SYSTEM

DTCH Relay Card

To check functions controlled by the safety system check the status indicators. (See Relay Box Assembly drawing.) If only one of the safety functions is not working, activate that function and check for error codes and/or its output status indicator.

For non-FM systems, if the status indicator lights then the problem is in the wiring or in the solenoid coil. If the light does not illuminate, check the control pendant. If the control pendant is good then the crane control module needs to be replaced.

For FM systems, check for error codes. If none are present, see the FM Troubleshooting section.

If boom out, boom down and winch up are not working, confirm that the control board has power. Confirm that the board is receiving a signal from the ATB and load sensor.

If the error code is active, ensure that the crane is not overloaded and that the ATB lever is holding the switch closed. Check for voltage at the ATB and Load Sensor inputs.

CHECK LOAD SENSOR SWITCH

If the load sensor input is not receiving voltage, locate the load sensor connector inside the crane housing. The plug side will have a red wire and a gray wire, the receptacle side will have a red and a white wire.

Disconnect and check for continuity between the two pins on the receptacle (switch side). If there is no continuity then the load sensor is bad and needs to be replaced.

CHECK ATB SWITCH

If the ATB input is not receiving voltage remove the ATB housing cover and disconnect the connector. Check for continuity on the switch side. Lifting the weight should break the continuity. If either of these conditions is incorrect the switch is bad and needs to be replaced.

CHECK CORD REEL

Check the ATB switch if not done so already. Locate the ATB connector inside the crane housing. The plug side will have a red wire and a black wire. The receptacle side will have a white wire and a black wire.

Disconnect the plug going to the switch. Check for continuity between the two pins on the receptacle. Have someone lift the weight on the ATB and continuity should be broken. If either of these conditions are incorrect then the cord reel is bad and needs to be replaced.

CHECK POWER TO SAFETY SWITCHES

If the safety switch is good, check for voltage at pin 1 (the red wire) on the plug. If there is no voltage, follow the wire back to the 6-pin power distribution plug, checking for breaks or shorts.

Remove the power distribution receptacle (cap).

NOTE!

Removing the cap will disconnect power to all electrical components. Be sure to replace the cap before continuing.

Check the cap for bent pins. Check that all wires are fully seated in the plug. If they are not, then remove the green locking wedge and push the wires forward until seated. Reinstall the wedge ensuring that no wires are pushed back.



DEUTSCH CONNECTIONS & PINS



FEMALE'S



MALE'S

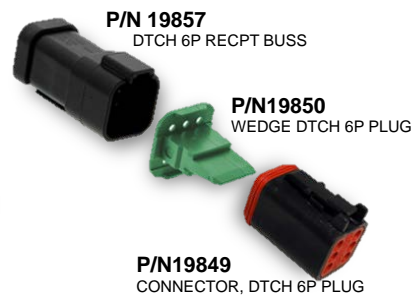
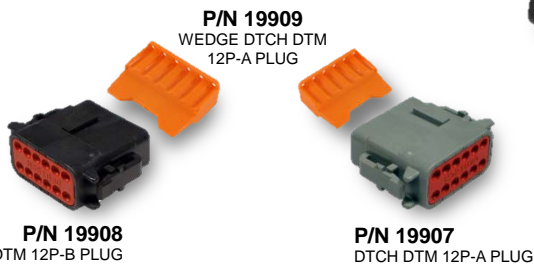
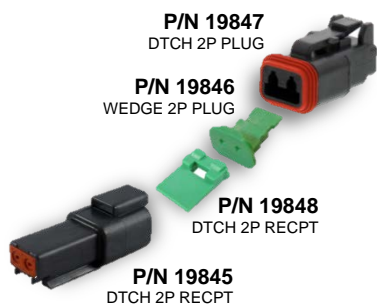

F2435-0
06/16/16
I:FORMS

HOUSTON, TEXAS
FAX: (800) 824-5559 (USA & Canada)
FAX: (713) 688-6324
PHONE: (713) 688-5533
www.liftmoore.com

THIS PAGE INTENTIONALLY LEFT BLANK

SECTION 3 CRANE SPECIFICATIONS

MODEL 3660 CRANES

MOMENT RATING 36000 FT-LBS

MAX SINGLE LINE LOAD 3000 LBS

MAX DOUBLE LINE LOAD 6000 LBS

LIFTING CAPACITIES AT VARIOUS LOAD RADII

LOAD RADIUS (FT)	CAPACITY (LBS)
<6	6000
6	6000
8	4500
10	3600
12	3000
14	2571
16	2250
18	2000
20	1800

POWERED FUNCTIONS AND EXPECTED TIMES

WINCH	UP: 6.3 s	DOWN: 6 s	1 REVOLUTION
BOOM ELEVATION	UP: 19 s	DOWN: 15 s	
BOOM EXTENSION	OUT: 26 s	IN: 18 s	
ROTATION	90° 12s		

HYDRAULIC REQUIREMENTS

PRESSURE	2750 PSI
FLOW	6 GPM

ELECTRICAL REQUIREMENTS

VOLTAGE	12 VDC
FUSE	15 AMP

NOTE: FUNCTION TIMES ARE BASED ON THESE INPUT VALUES



F1118-D
9/7/16

HOUSTON, TEXAS
FAX: (800) 824-5559 (USA & Canada)
FAX: (713) 688-6324
PHONE: (713) 688-5533
www.liftmoore.com

PERIODIC MAINTENANCE SCHEDULE		
MODEL 3660 CRANES		
BOLTS		
MOUNTING BOLTS	7/8-9 GRADE 8 TORQUE 600FT-LBS DRY	EVERY 4 MONTHS
BEARING BOLTS	5/8-11 GRADE 8 TORQUE 220FT-LBS DRY	EVERY 4 MONTHS
LUBRICATION		
GREASE FITTINGS	SEE DRAWING 50048	EVERY OTHER WEEK
HYDRAULIC FLUID	STANDARD Chevron AW Hydraulic Oil 46 or equivalent SAE 15 weight oil COLD WEATHER AW 32 or equivalent SAE 10 weight oil	CHECK DAILY, FILL AS NEEDED
WINCH GEARBOX	Sunep 460 or equivalent ISO Grade 460 or AGMA Grade 7EP	EVERY MONTH
ROTATION GEARBOX	Sunco Prestige 740 EP or NLGI Grade 0	EVERY MONTH
BEARING (ZERK AND TEETH)	Oil Center Research PM 600 Military grease or equivalent Benton Based Grease NLGI Grade 2	EVERY 6 HOURS OF OPERATION



CRANE LUBRICATION POINTS

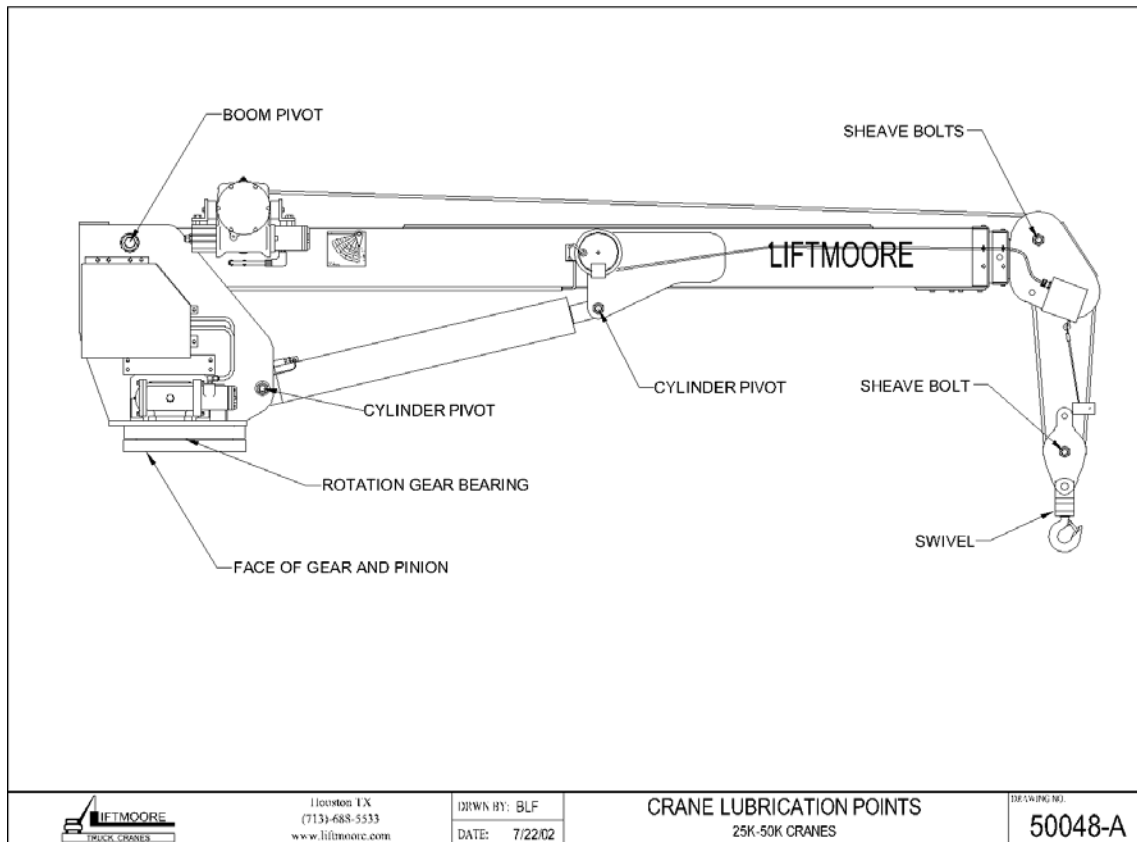

F1118-D
9/7/16

HOUSTON, TEXAS
 FAX: (800) 824-5559 (USA & Canada)
 FAX: (713) 688-6324
 PHONE: (713) 688-5533
 www.liftmoore.com

THIS PAGE INTENTIONALLY LEFT BLANK



F1118-D
9/7/16

HOUSTON, TEXAS
FAX: (800) 824-5559 (USA & Canada)
FAX: (713) 688-6324
PHONE: (713) 688-5533
www.liftmoore.com

LIST FOR BOX, CRANE PARTS 3660FP SPECIAL

Items with * have detailed DWG's.

P/N 28607 - BOX, CRANE PARTS 3660FP SPECIAL
W/O WINCH, CROWN PLATE, ROPE

- 1) P/N 26749- MANUAL, CRANE 3660X SPECIAL.....1pc
- 2) P/N 19487 - CW, 10 GA X 300"1pc
- 3) P/N 18457 - FUSE HOLDER, ATO 12GA SEALED.....1pc
- 4) P/N 21154 - FUSE, 30 AMP BLADE.....1pc
- 5) P/N 32613 - ADAPTER, 8MJ-10MJ.....1pc
- 6) P/N 17012 - SWITCH, TOGGLE SPST MAINT. /S1pc
- 7) P/N 17011 - BRACKET, SWITCH MNT. HYD. CRN.....1pc
- 8) P/N 16781 - TERMINAL, RING 10-12 GA #8.....2pcs
- 9) P/N 17013 - PLATE, ON-OFF FOR TOGGLE SWCH.1pc
- 10) P/N 22426 - INSTALLATION INTS. 2550,3660..1pc
- 11) P/N 18600 - PLATE, CRANE-TRUCK STABILITY CHART.....1pc
- 12) P/N 25049 - DECAL, LOAD CAPACITY 36,0002pc
- 13) P/N 23144 - LEVEL & TAPE ASSEMBLY.....1pc
- 14) P/N 20135 - DECAL KIT 3660X-201pc



F2515-0
10/06/17

HOUSTON, TEXAS
FAX: (800) 824-5559 (USA & Canada)
FAX: (713) 688-6324
PHONE: (713) 688-5533
www.liftmoore.com

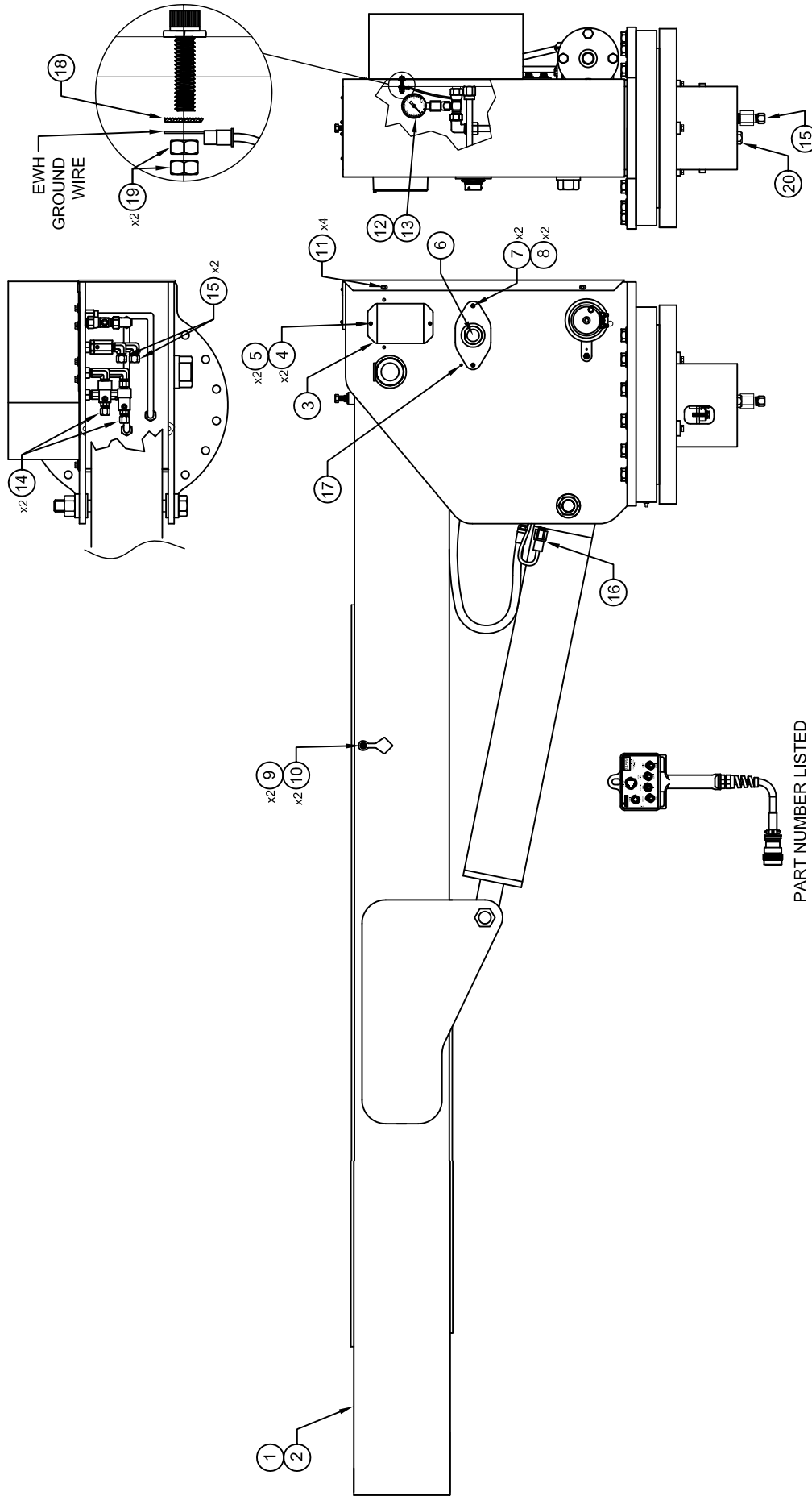

PART NUMBER LISTED
ONLY FOR REFERENCE
24694

#	PN	DESCRIPTION	QTY	#	PN	DESCRIPTION	QTY	#	PN	DESCRIPTION	QTY
1	26748	BOOM-BODY ASSY 3660X/XP SPECL	1	7	30457	SCREW, HHC 0.25-20 X 0.75 GR5	2	13	23135	ADAPTER, 4FP-6FJ SWIVEL	1
2	PFORM53	TEST SHEET 3660X REV-B	1	8	30689	WASHER, LOCK 0.25 GR5 PLATED	2	14	32377	ADAPTER, CAPNUT # 6	2
3	22569	BOARD, RELAY 3RD G XP ATB-BD	1	9	22394	PENDULUM, LOAD RADIUS DIA. HD	2	15	32499	ADAPTER, CAPNUT # 8	3
4	17164	SCREW, SOC HD 10-24 X 0.62 SS	2	10	31017	SCREW, SHOULDER 0.31-18 X 0.75	2	16	20415	SWITCH, PRES ASSY 2050PSI DTCH	1
5	32639	WASHER, LOCK #10 GR2 PLATED	2	11	32589	SCREW, HWHSMS 0.25-20 X 0.75	4	17	30989	SCREW, HWHSMS # X 0.50	1
6	25125	EWH, DTCH HYD XP TO X KT-RB	1	12	23123	PRESSURE GAUGE, 0-3000 PSI	1	18	21520	WASHER, LOCK 0.25 STAR	1
								19	30830	NUT, HEX 0.25-20 GR2	2
								20	32500	ADAPTER, CAPNUT #10	1
										NOT SHOWN	
								21	21789	CONNECTOR, DTCH 2P RECP JUMPER	1

Houston TX
(713)-688-5533
www.liftmoore.com

LIFTMOORE
TRUCK CRANES

DRAWN BY: AT
DATE: 10/10/17

CRANE ASSY 3660FP-16 SPEC
W/O WINCH, CROWN PLATE, ROPE

DRAWING NO.
28605-0

Item	Qty.	Part No.	Description
1	1	32004BB	PENDANT WITH HALL TRIGGER AND BACK COVER
2	1	32004KA	CABLE ASSEMBLY WITH CONNECTOR AND INTERNAL JUMPERS
3	1	058-020-3234	GRD GRIP, ST THRU PLST, 3/4" NPT
4	1	070-010-1832	DECAL, PENDANT, GUIDER, 4SW, LIFTMOORE
5	4	240-011-0017	SW, TOGGLE, SPDT, (ON)-OFF-(ON), QUICK CONNECT
6	4	240-015-0060	SW, SEALING BOOT, BLACK, TOGGLE - 15/32-32NS
7	1	240-109-8002	SW, PUSH BUTTON, N.O., GREEN DOME, SCREW CONNECT
8	1	240-110-0301	SW, E-STOP, TWIST TO RELEASE, NC CONTACT

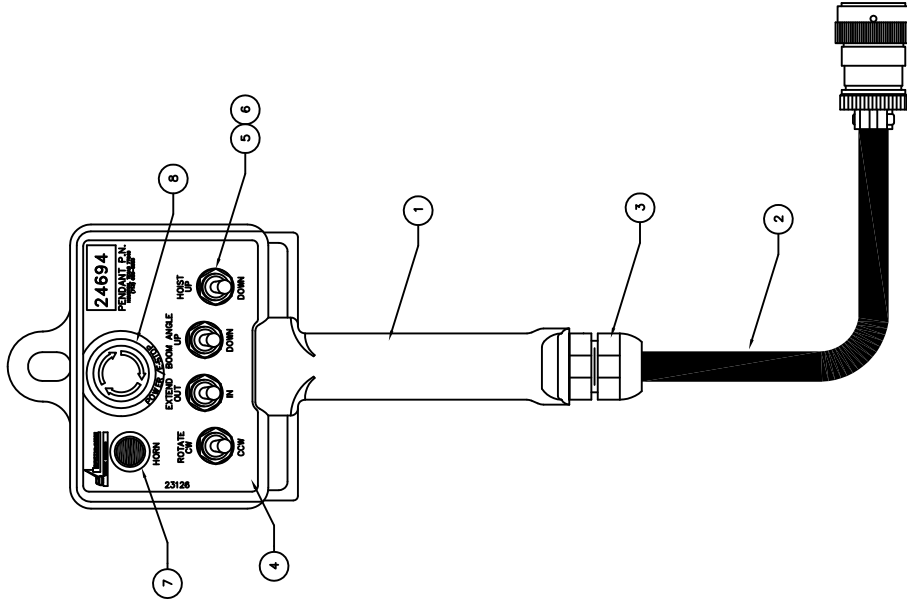

HD36-18-14SN-059

PIN	COLOR	DESCRIPTION
A	BLUE/RED	HORN
B	BLACK	TRIGGER GROUND
C	NC	NC
D	NC	NC
E	RED	SWITCHES SUPPLY +12V
F	YELLOW	ROTATION CW
G	RED/BLACK	BOOM UP
H	BROWN/BLACK	BOOM DOWN
J	ORANGE/BLACK	WINCH UP
K	BROWN	TRIGGER SIGNAL
L	ORANGE	ROTATION CCW
M	BLUE	EXTENSION OUT
N	YELLOW/BLACK	EXTENSION IN
P	BLUE/BLACK	WINCH DOWN

Houston TX
 (713)-688-5533
 www.liftmoore.com



DRWN BY: JE
 DATE: 10/25/11

CONTROL, PENDANT XP HALL TRIG
 HALL EFF. TRIGGER W/ E-STOP, HORN

DRAWING NO.
24694-F

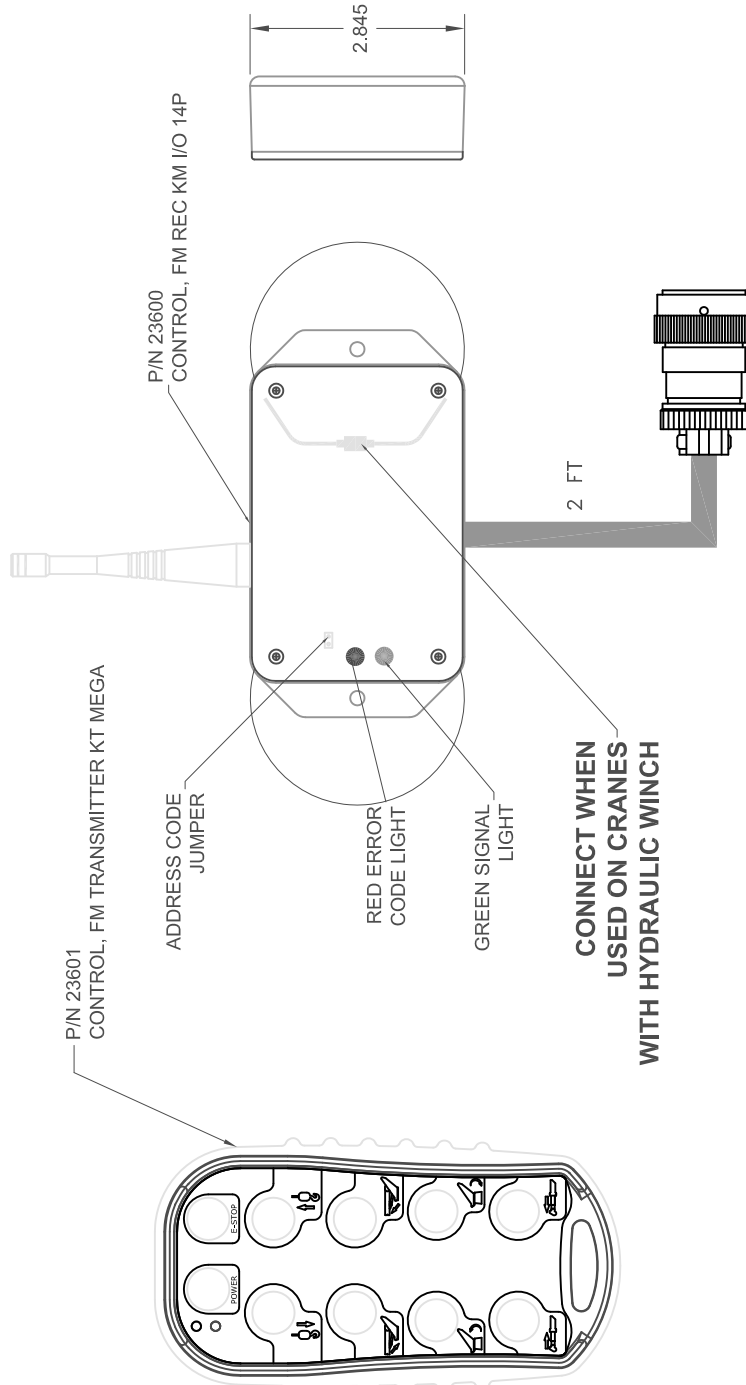

- TEACH ID CODE:-**
1. Remove receiver cover.
 2. Apply power to the receiver.
 3. Place a jumper across the TEACH ID jumper inside the receiver. The green LED will go from blinking to steady. Remove the jumper.
 4. Press and hold power button on the transmitter for more than 10 seconds. Both LED's will blink at this time.
 5. Receiver green LED will go from steady to blinking when teaching is complete.
 6. Replace the cover on the receiver.

DEUTSCH HC36-18-14SN-059

PIN	DESCRIPTION
A	INC
B	GROUND
C	E-STOP
D	INC
E	POWER
F	ROTATION CW
G	BOOM UP
H	BOOM DOWN
J	WINCH UP
K	PUMP
L	ROTATION CCW
M	BOOM OUT
N	BOOM IN
P	WINCH DOWN



Houston TX
 (713)-688-5533
 www.liftmoore.com

DRWN BY: JE
 DATE: 9/17/10

MEGA FM CONTROL

DRAWING NO.

23693-B

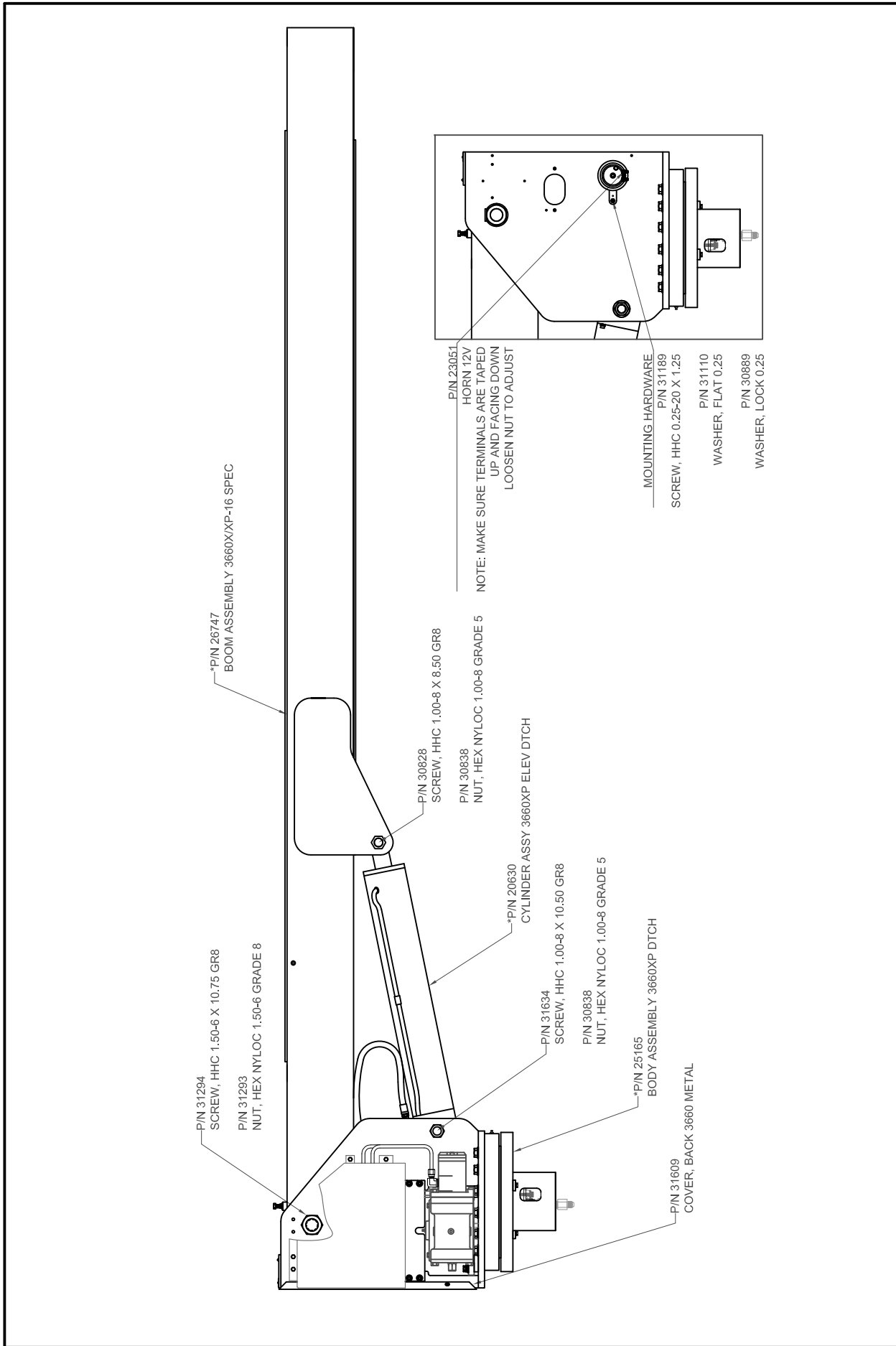

	Houston TX (713)-688-5533 www.liftmoore.com	DRWN BY: AA DATE: 09/04/14	DRAWING NO. 26748-0
	BOOM-BODY ASSY 3660X/XP SPECIAL W/O WINCH, CROWN PLATE, ROPE		

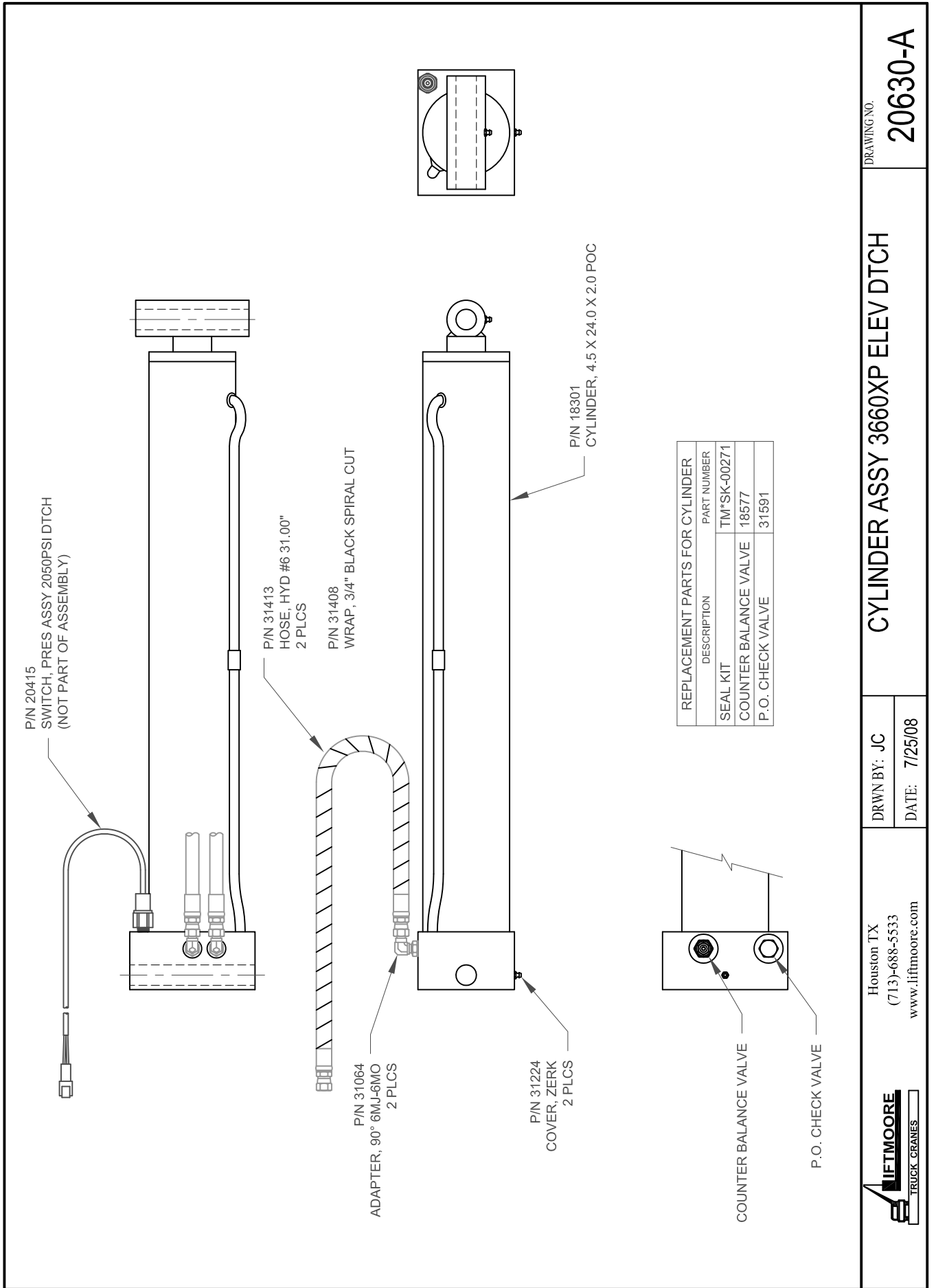

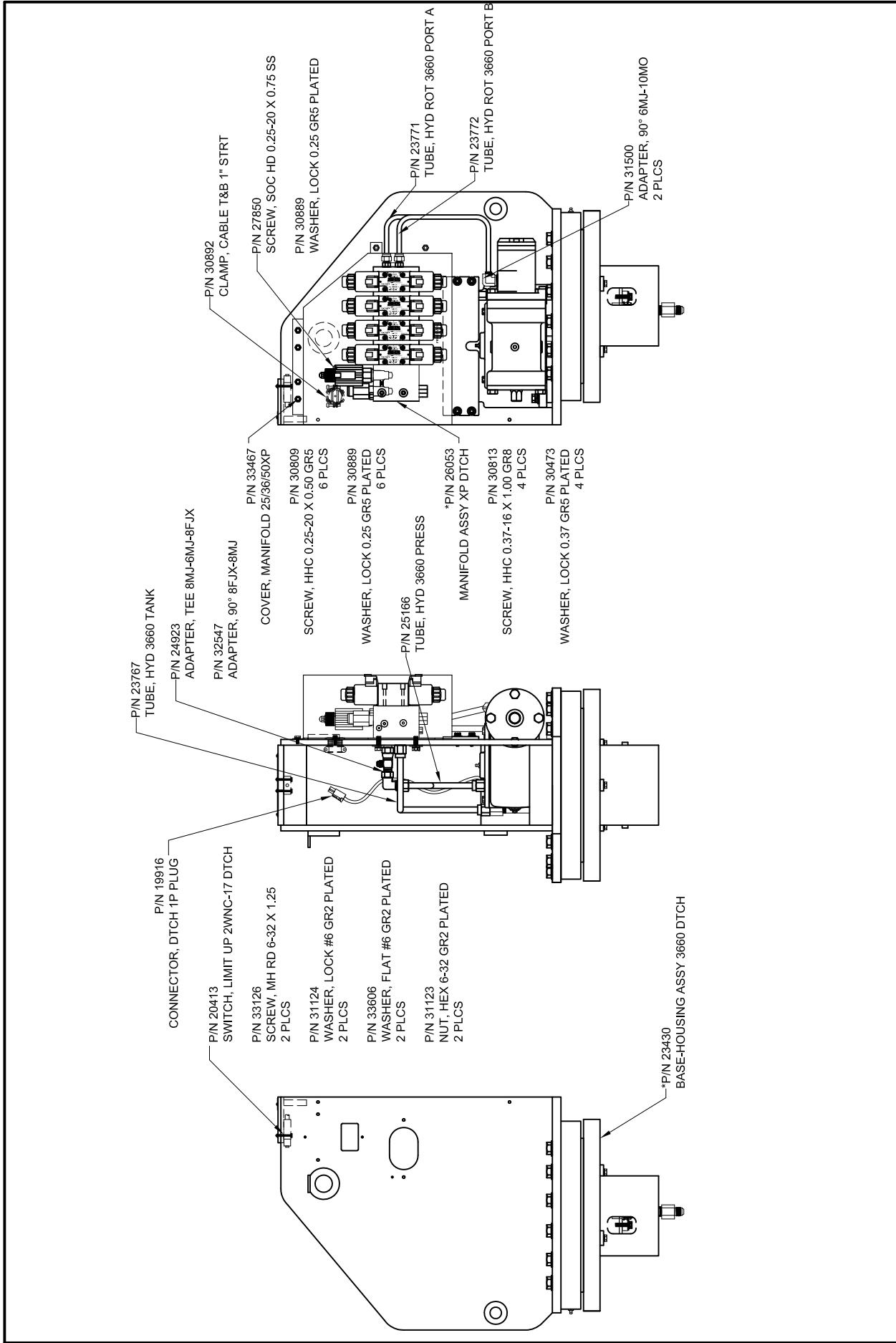

- P/N 23767 TUBE, HYD 3660 TANK
- P/N 24923 ADAPTER, TEE 8MJ-6MJ-8FJX
- P/N 32547 ADAPTER, 90° 8FJX-8MJ
- P/N 33467 COVER, MANIFOLD 25/36/50XP
- P/N 30809 SCREW, HHC 0.25-20 X 0.50 GR5 6 PLCS
- P/N 30889 WASHER, LOCK 0.25 GR5 PLATED 6 PLCS
- *P/N 26053 MANIFOLD ASSY XP DTCH
- P/N 30813 SCREW, HHC 0.37-16 X 1.00 GR8 4 PLCS
- P/N 30473 WASHER, LOCK 0.37 GR5 PLATED 4 PLCS
- P/N 19916 CONNECTOR, DTCH 1P PLUG
- P/N 20413 SWITCH, LIMIT UP 2WNC-17 DTCH
- P/N 33126 SCREW, MH RD 6-32 X 1.25 2 PLCS
- P/N 31124 WASHER, LOCK #6 GR2 PLATED 2 PLCS
- P/N 33606 WASHER, FLAT #6 GR2 PLATED 2 PLCS
- P/N 31123 NUT, HEX 6-32 GR2 PLATED 2 PLCS
- *P/N 23430 BASE-HOUSING ASSY 3660 DTCH
- P/N 27850 SCREW, SOC HD 0.25-20 X 0.75 SS
- P/N 30889 WASHER, LOCK 0.25 GR5 PLATED
- P/N 23771 TUBE, HYD ROT 3660 PORT A
- P/N 23772 TUBE, HYD ROT 3660 PORT B
- P/N 31500 ADAPTER, 90° 6MJ-10MO 2 PLCS

DRAWING NO.
25165-C

BODY ASSEMBLY 3660XP DTCH
SD VALVE W/ HORN

DRWN BY: AA
DATE: 09/18/12

Houston TX
(713)-688-5533
www.liftmoore.com





BY: AA
DATE: 09/02/13

MANIFOLD ASSY XP DTCH
3660, SWIVEL FITTING

DOCUMENT NO.

26053-A

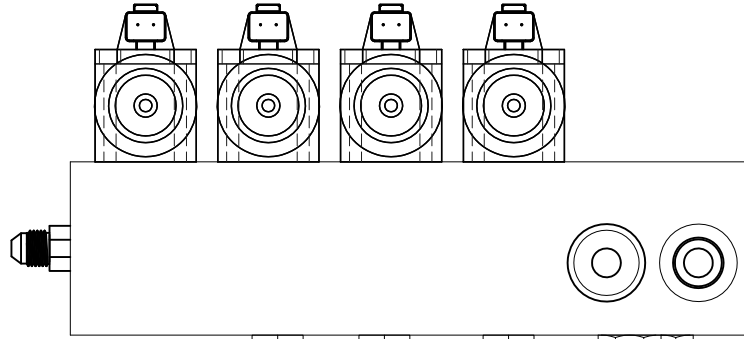

TOP VIEW

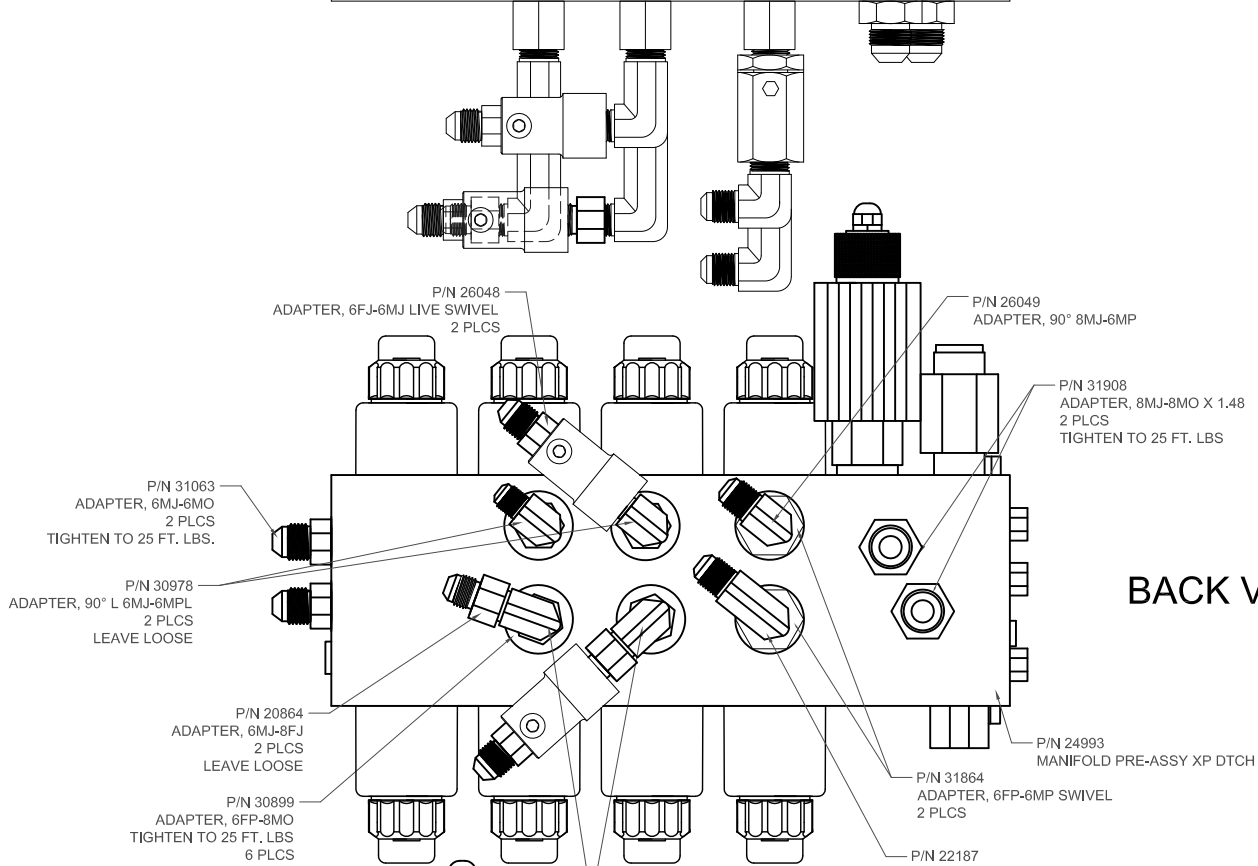

BACK VIEW

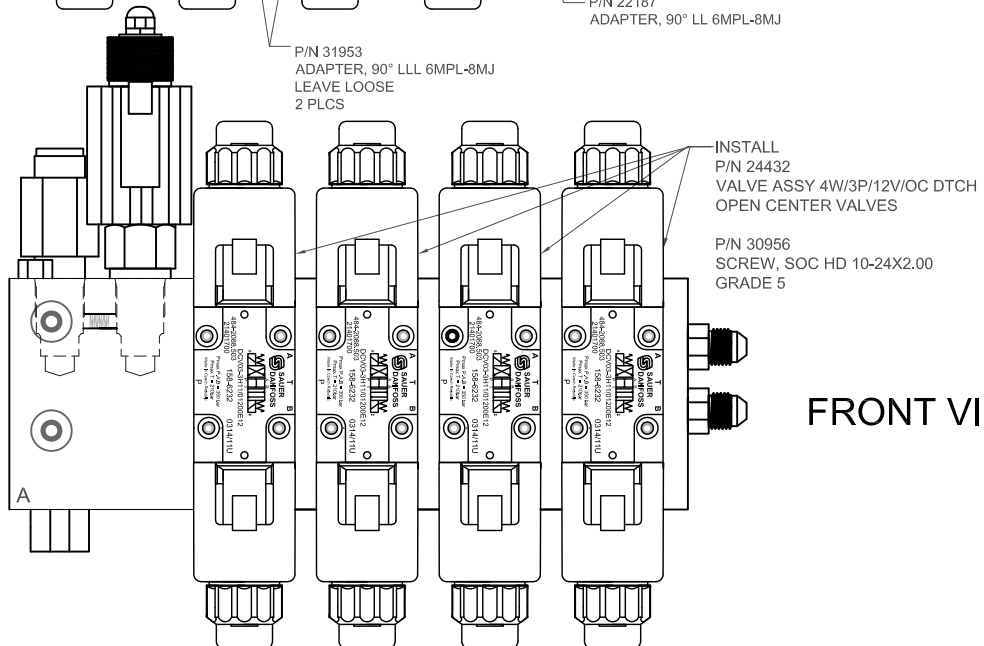

FRONT VIEW

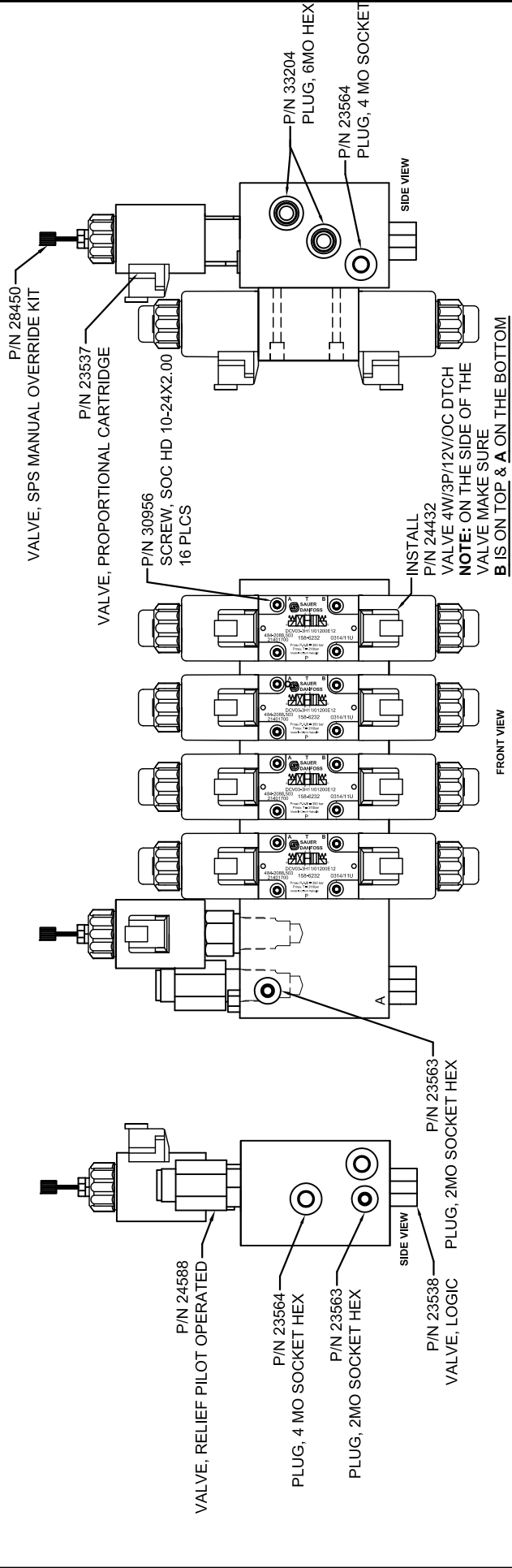
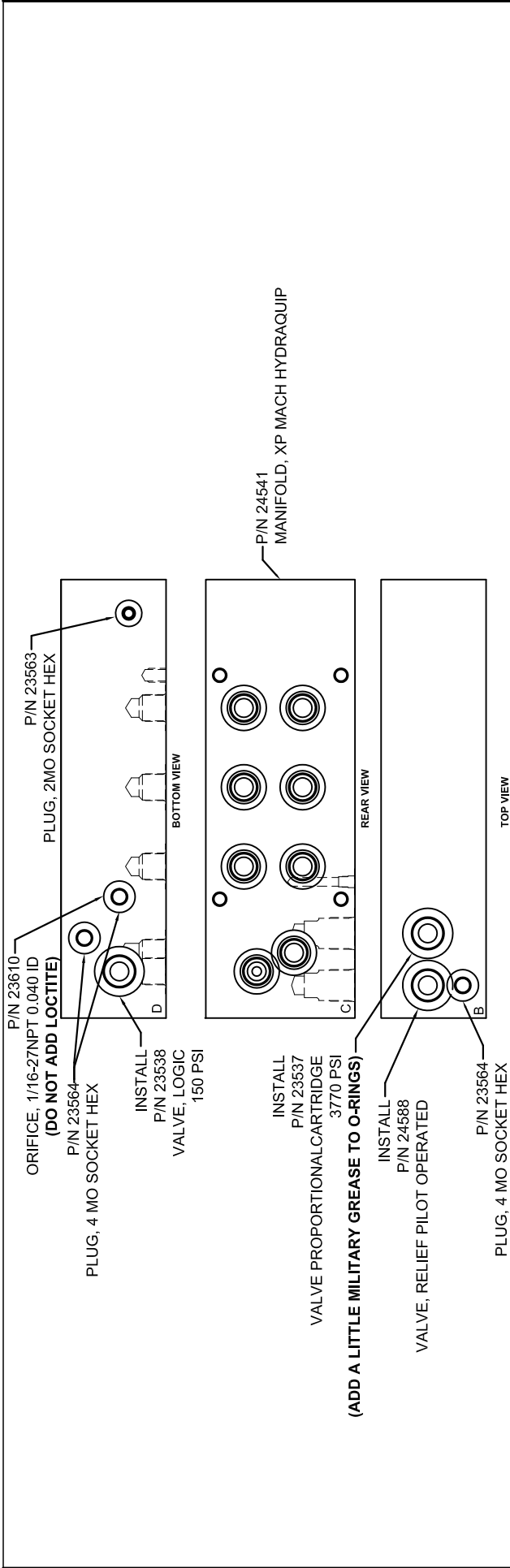

DRAWING NO.
24993-B

MANIFOLD PRE-ASSY XP DTCH

DRWN BY: JE
DATE: 6/4/12

Houston TX
(713)-688-5533
www.liftmoore.com

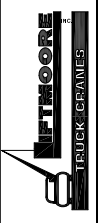

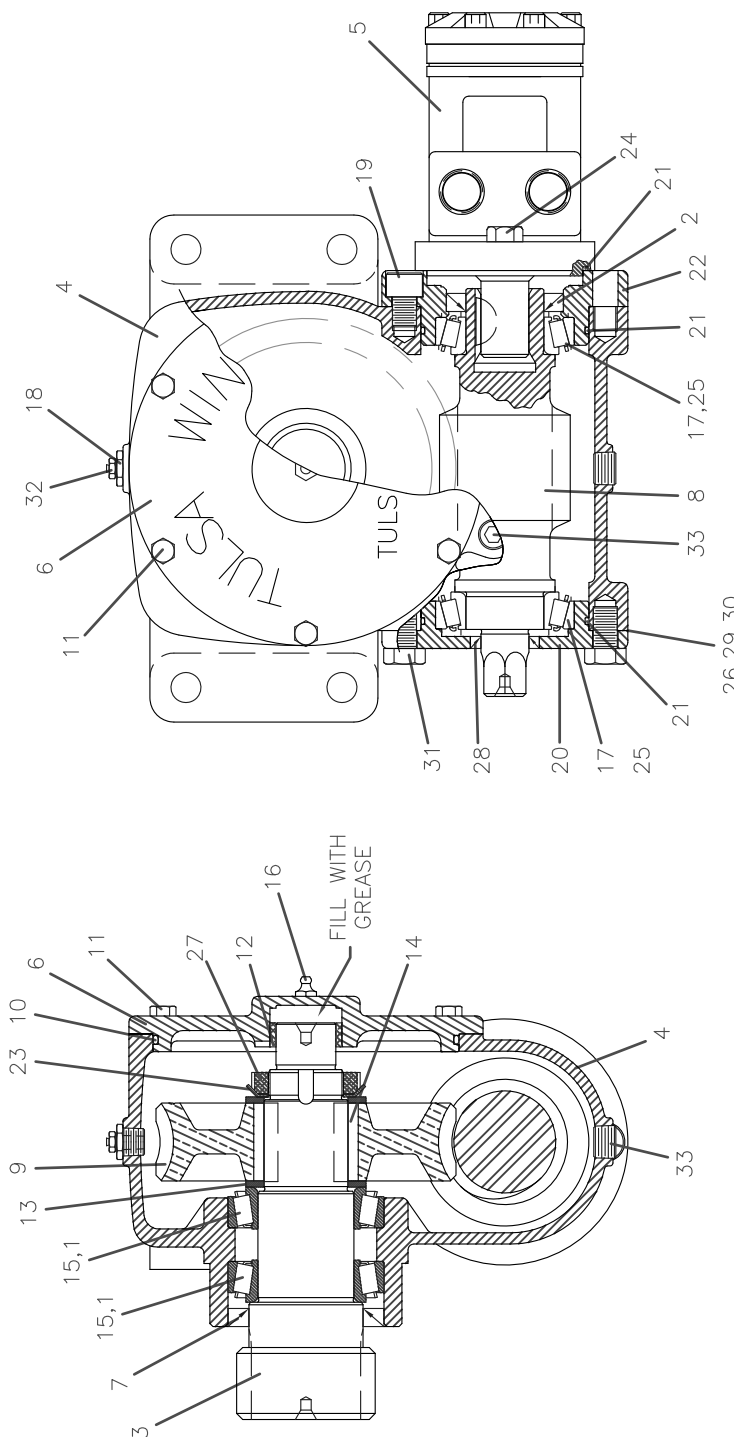

#	PN	DESCRIPTION	QTY	#	PN	DESCRIPTION	QTY	#	PN	DESCRIPTION	QTY
1	TW*41983	CUP, BEARING, HFG93	2	13	TW*40510	WASHER, THRUST	2	25	TW*996516	CUP, BEARING	2
2	TW*33155	SEAL, OIL	1	14	TW*40518	KEY	2	26	TW*42366	SHIM, G1600D	2
3	TW*43742	SHAFT, OUTPUT, PINION	1	15	TW*41982	CONE, BEARING, HFG9	2	27	TW*26528	LOCKNUT	1
4	TW*43492	HOUSING, 900D	1	16	TW*21128	FITTING, GREASE ZERK	1	28	TW*24180	SEAL, OIL	1
5	TW*42765	MOTOR, HYDRAULIC	1	17	TW*996515	CONE, BEARING	2	29	TW*42367	SHIM, G1600D	2
6	TW*42000	COVER, HFG938D	1	18	TW*12208	BUSHING, PIPE	1	30	TW*42368	SHIM, G1600D	2
7	TW*41979	SEAL, OIL, HFG938D	1	19	TW*43537	CAPSCREW, SOCKET HEAD	2	31	TW*24943	CAPSCREW	4
8	TW*43745	WORM, SR, HFG945D	1	20	TW*43467	CAP, END, 900D	1	32	TW*20375	BREATHER	1
9	TW*42578	GEAR, SR, HFG945D	1	21	TW*32566	O-RING	3	33	TW*32220	PLUG, PIPE	2
10	TW*40547	O-RING	1	22	TW*43465	CAP, END, MOTOR	1	34	TW*709169	PAINT, WHITE	1
11	TW*40407	CAPSCREW	6	23	TW*41299	LOCKWASHER	1				
12	TW*17451	BUSHING, HFG900D	1	24	TW*10381	CAPSCREW	2				

Houston TX
(713)-688-5533
www.iftmoore.com

DRWN BY: SJN
DATE: 9/5/02

REDUCER, SPEED TULSA BEARING

DRAWING NO. 20232-0

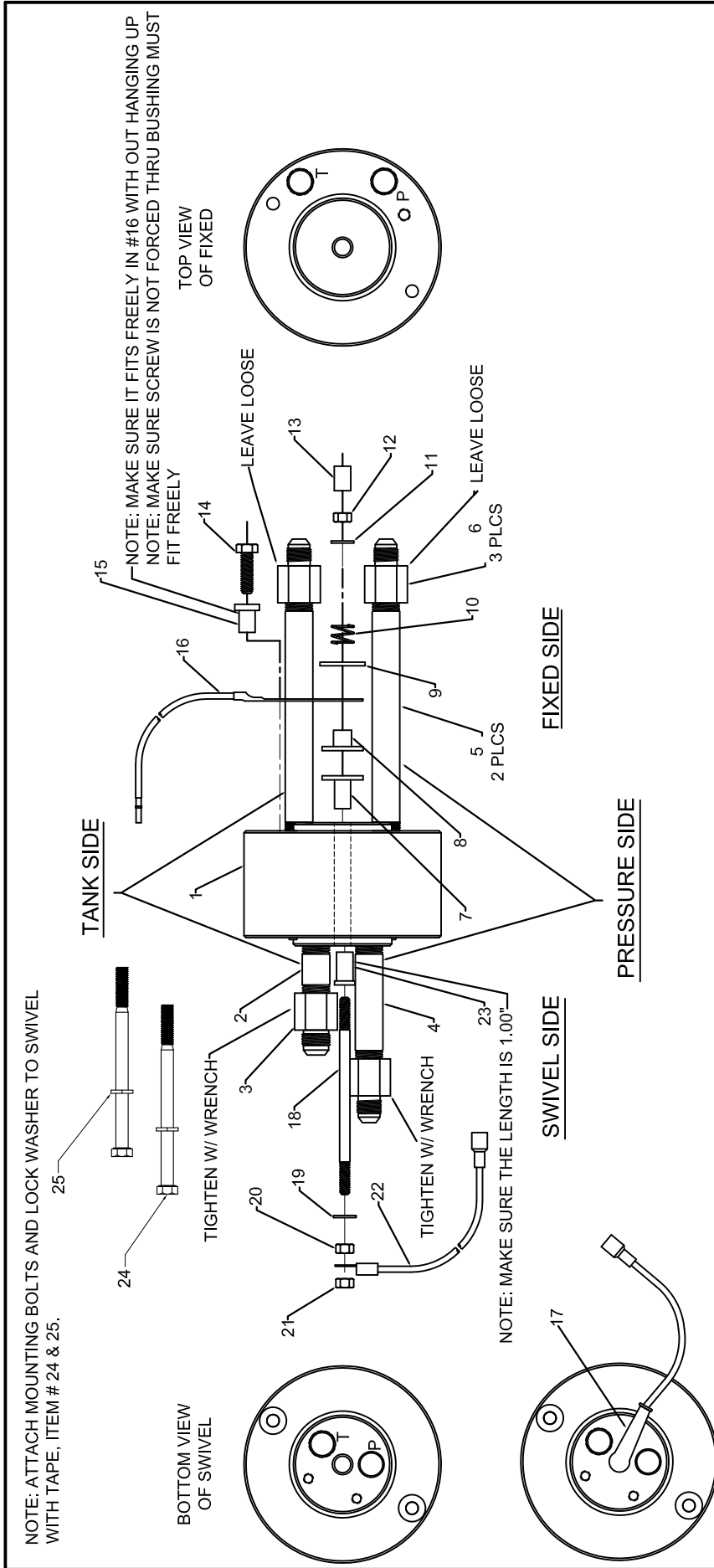

NOTE
ON THE BOTTOM OF THE SWIVEL, THE TANK PORT USES A #10 FITTING, AND THE PRESSURE PORT USES A #8 FITTING.

#	PN	DESCRIPTION	QTY	#	PN	DESCRIPTION	QTY	#	PN	DESCRIPTION	QTY
1	28144	SWIVEL, HYDRAULIC 1/2" PORTS	1	9	32562	WASHER, FLAT 0.50 SS GRADE 304	1	17	30674	BOOT, RUBBER 1 & 1/0	1
2	31996	ADAPTER, NIPPLE 2.50" LG #8	1	10	31452	SPRING, SWIVEL	1	18	32277	STUD, 5/16-18 X 6 DOUBLE END	1
3	32468	ADAPTER, 8FP-10MJ	1	11	32368	WASHER, FLAT 0.37 SAE SS GR304	1	19	33353	WASHER, FLAT 0.31 SAE SS304	1
4	32321	ADAPTER, NIPPLE 4.00" LG #8	1	12	34256	NUT, HEX NYLOC 0.31-18 SS 304	1	20	34255	NUT, HEX 0.31-18 SS 304	1
5	32131	ADAPTER, NIPPLE 8.00" LG #8	2	13	32279	SLEEVE, SWIVEL SCREW INSULATOR	1	21	34256	NUT, HEX NYLOC 0.31-18 SS 304	1
6	31995	ADAPTER, 8FP-8MJ	3	14	23063	SCREW, HHC 0.37-16 X 1.25 GR8	1	22	32278	WIRE, SWIVEL SUPPLY W/TERMINAL	1
7	31382	SPACER, SWIVEL STUD INSULATOR	1	15	31451	INSULATOR, BOLT ELECTRIC	1	23	31383	SPACER, SWIVEL STUD INSULATOR	1
8	31381	SPACER, SWIVEL UPPER - BRONZE	1	16	20500	WIRE, SWIVEL HOT PLATE ASSY D	1	24	28146	SCREW, HHC 0.37-16 X 5.50 GR8	2
								25	30473	WASHER, LOCK 0.37 GR5 PLATED	2

LIFTMOORE
TRUCK CRANES

Houston TX
(713)-688-5533
www.liftmoore.com

DRWN BY: JE

DATE: 8/16/16

SWIVEL, HYD/ELEC ASSY DTCH CTB
1/2" PORTS, COUNTER BORE HOLE

DRAWING NO.
28161-0

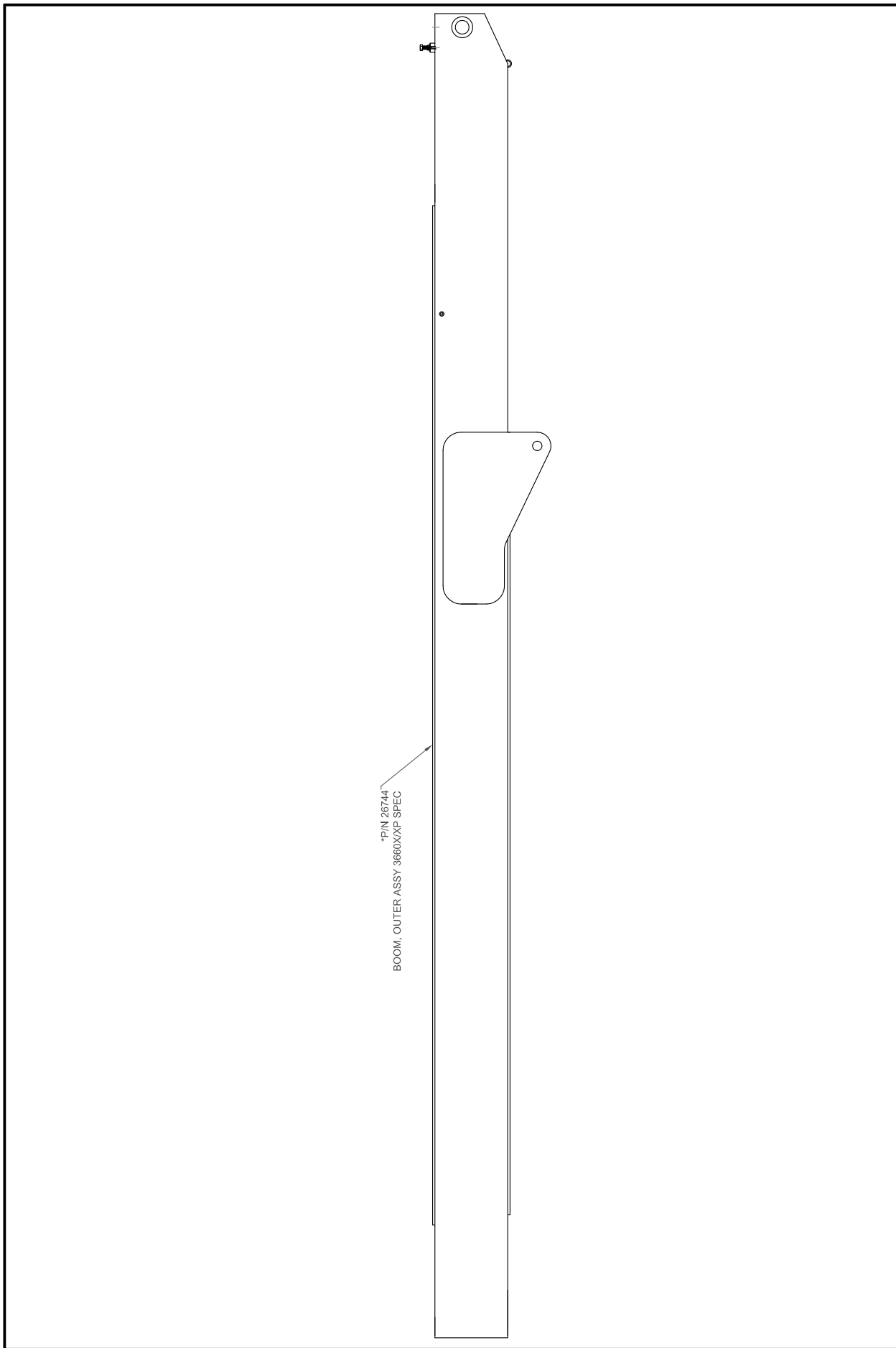

DRAWING NO. 26747-0	BOOM ASSEMBLY 3660X/XP SPECIAL W/O WINCH, CROWN PLT, ROPE	DRWN BY: AA	DATE: 09/04/14
Houston TX (713)-688-5533 www.liftmoore.com			

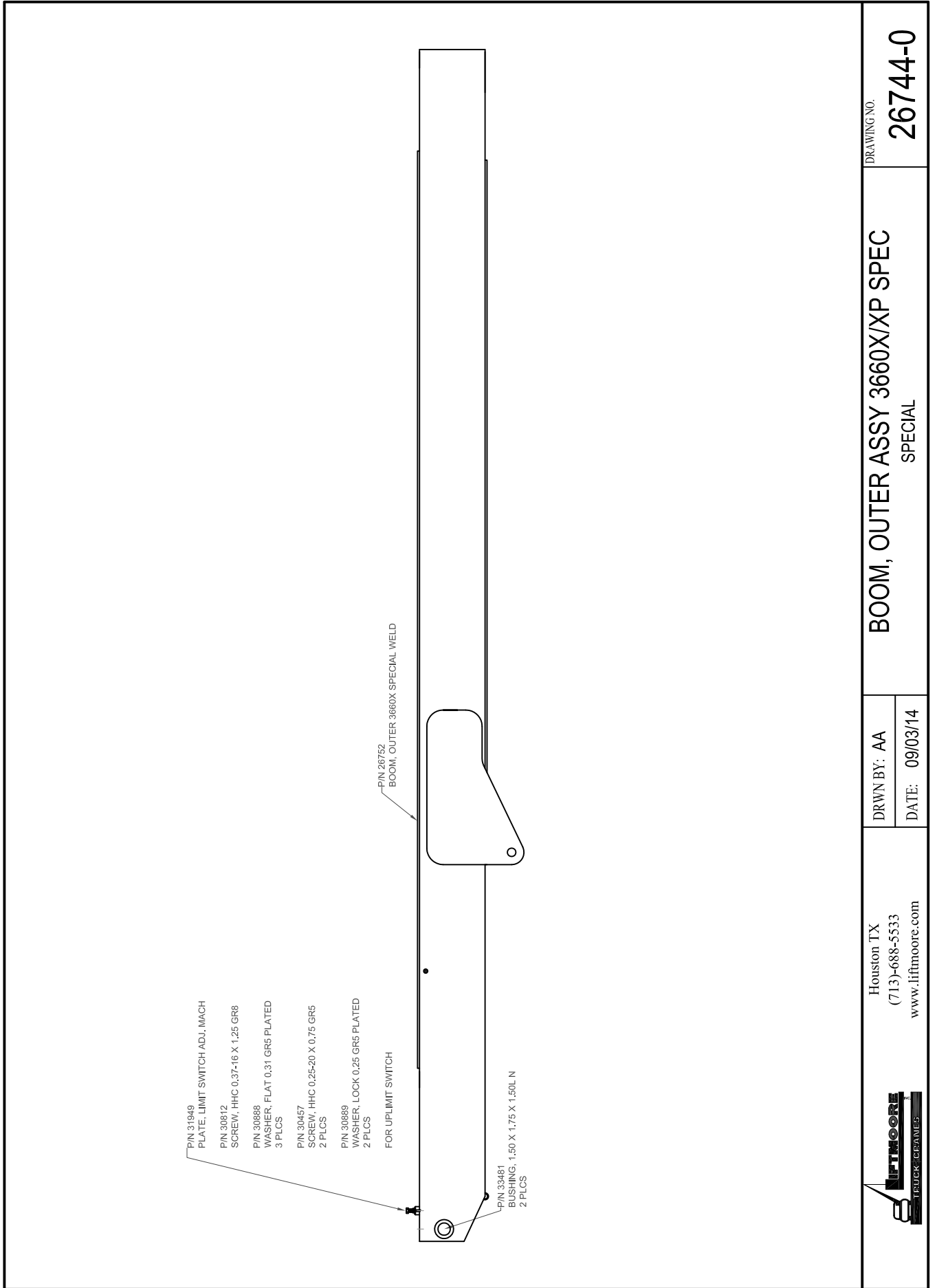

DRAWING NO.
26744-0

BOOM, OUTER ASSY 3660X/XP SPEC
SPECIAL

DRWN BY: AA
DATE: 09/03/14

Houston TX
(713)-688-5533
www.liftmoore.com

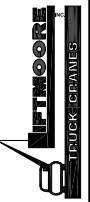

NOTE A:
FOR J-14
INSTALL 16GA. WHT PLUGS AT
PIN LOCATIONS: J14-C, D; P6.6 &
P12-B, 12

CIRCUIT NUMBER AND DESCRIPTION		
Wire Color	Wire Length	Function
BLU/BLK	30"	J14-A HORN OUTPUT
YEL	22"	J14-B TRIG GRND
WHT	12"	J14-E PWR, SOC
RED	32"	J14-F P2-R, 1 ROT CW
GRN	18"	J14-G P2-U, 1 ELEV UP
ORN	16"	J14-H P12A, 7 ELEV DWN
BLU	16"	J14-J P12A, 6 HOIST UP
WHT/BLK	16"	J14-K P12A, 2 TRIG SIG
RED/BLK	32"	J14-L P2-RA, 1 ROT CCW
GRN/BLK	18"	J14-M P12A, 8 EXT OUT
ORN/BLK	28"	J14-N P2-X, 1 EXT IN
BLK	26"	J14-P P2-H, 1 HOIST DWN
BRN	26"	P12A, 1 TR-2 GRND
YEL/BLK	26"	P12A, 3 P2-P, 1 PROP
GRY	18"	P12A, 4 P2-PS, 2 PRESS SW
BLK	18"	P12A, 5 P2-ATB, 2 ATB
WHT	34"	P12A, 9 P2-XA, 1 EXT. OUT VAL
YEL	36"	P12A, 10 P2-LA, 1 ELEV DWN VAL
PUR	32"	P12A, 11 P2-HA, 1 HOIST UP VAL
YEL	N/A	P6.1 MAIN PWR FUSE HOLDER
RED	18"	P6.2 P12A, 12 POWER
RED	14"	P6.4 P2-ATB, 1 PWR, ATB
RED	14"	P6.5 P2-PS, 1 PWR, PS
GRN	24"	P2-U, 2 P2-L, 1 ELEV UP

BRN	P12B, 1 TR-2 MAIN GROUND
BRN	P2-HA, 2 HOIST UP VAL GND
BRN	P12B, 2 P2-H, 2 HOIST UP VAL GND
BRN	P2-L, 2 ELEV UP VAL GND
BRN	P12B, 4 P2-L, 2 ELEV DWN VAL GND
BRN	P12B, 6 P2-XA, 2 EXT. OUT VAL GND
BRN	P12B, 7 P2-X, 2 EXT IN VALVE GND
BRN	P12B, 8 P2-RA, 2 ROT. CCW VALVE
BRN	P2-R, 2 ROT. CW VALVE
BRN	P12B, 9 P2-P, 2 PROP. GND
BRN	P12B, 10 P2-P, 2 HORN GND
BRN	P12B, 11 BF

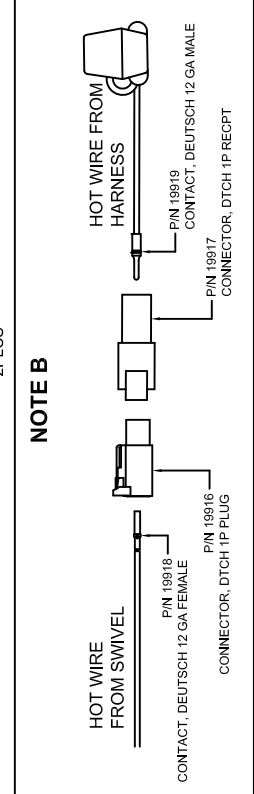
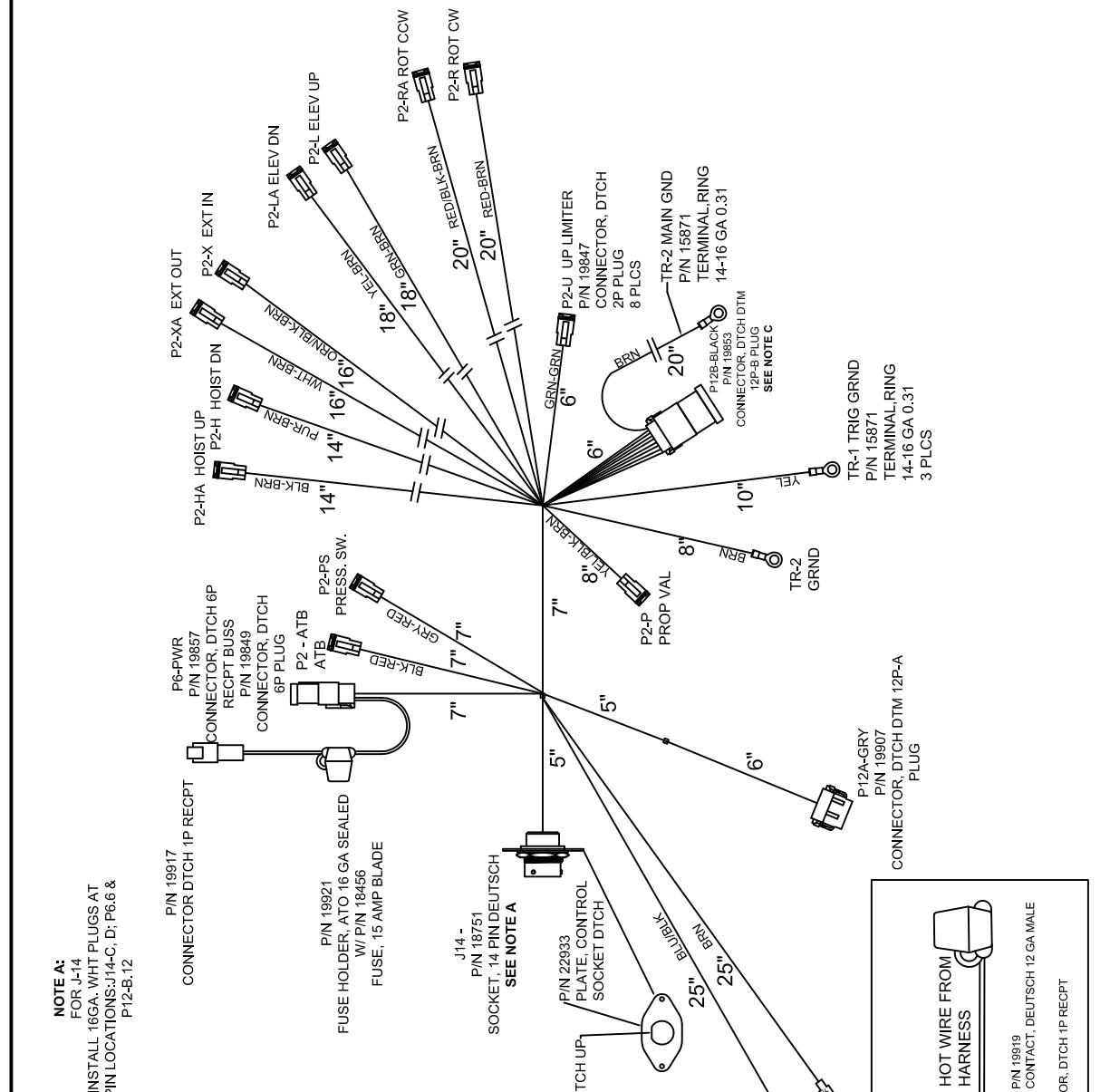

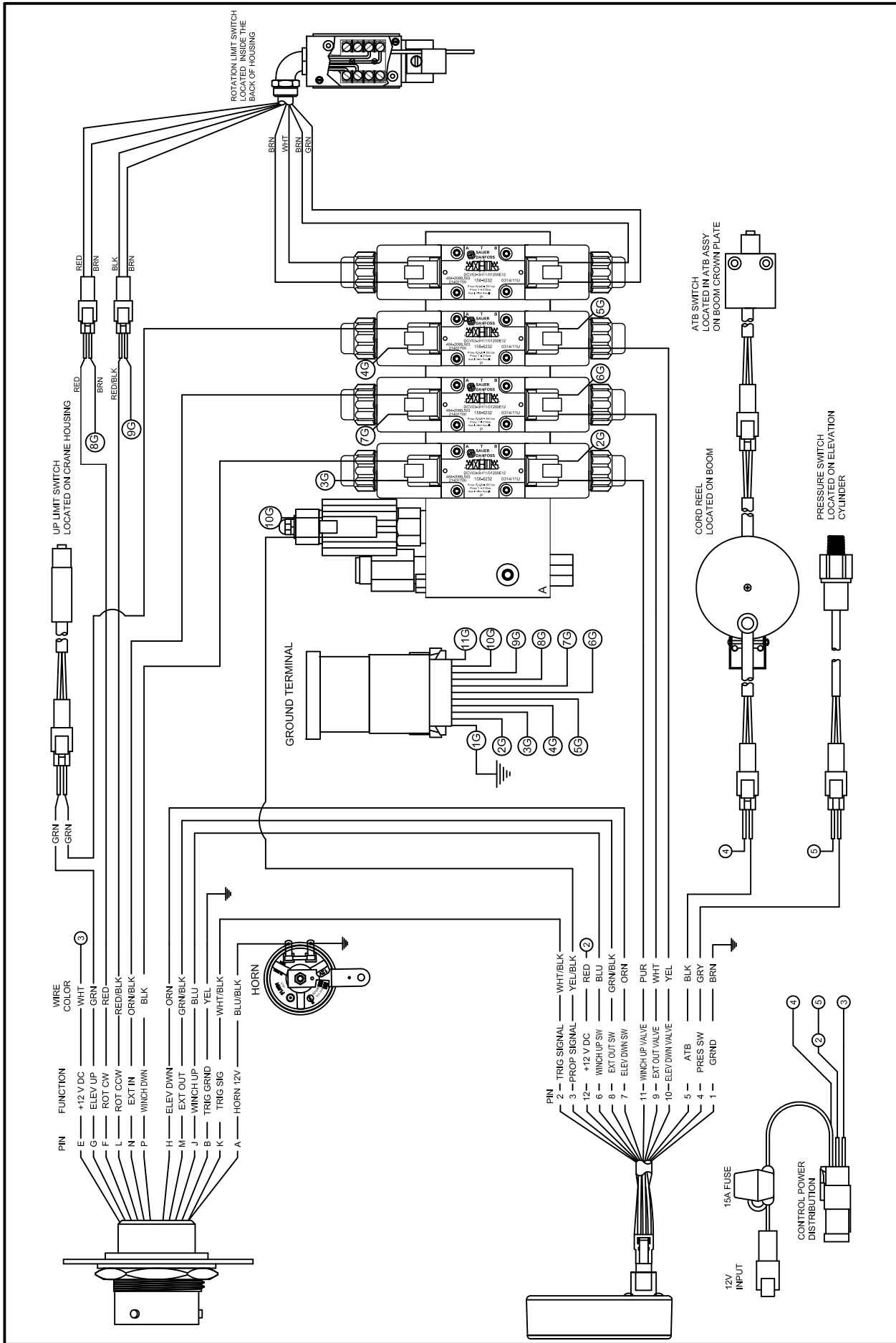

DRAWING NO. 50890-0

SCHEM, ELEC WIRING DTCH 3RD G XP ATB-BD
 HALL EFFECT, LIMIT ROTATION

DRWN BY: JE
 DATE: 2/15/17

Houston TX
 (713)-688-5533
 www.liftmoore.com



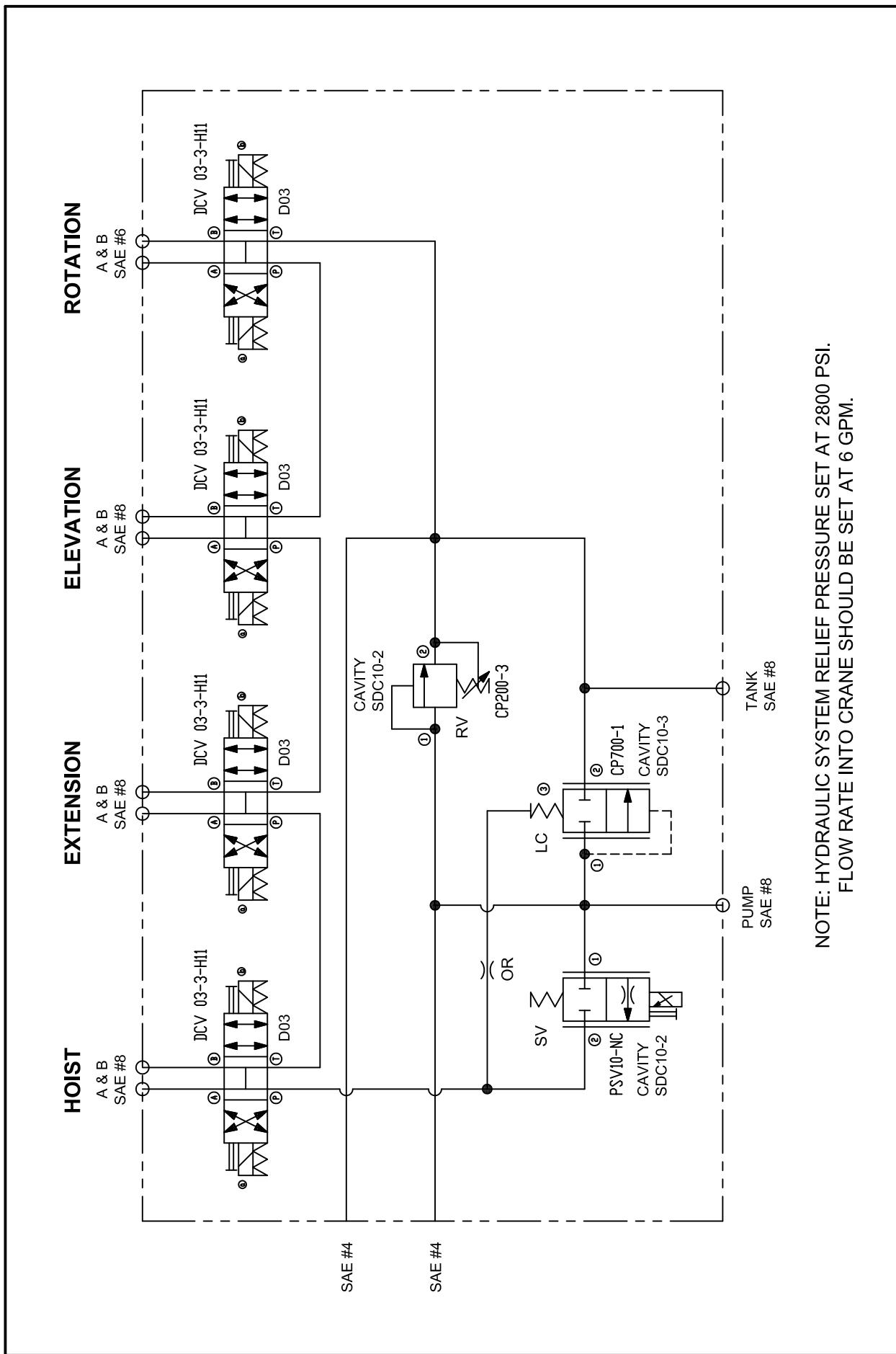

NOTE: HYDRAULIC SYSTEM RELIEF PRESSURE SET AT 2800 PSI.
FLOW RATE INTO CRANE SHOULD BE SET AT 6 GPM.

	Houston TX (713)-688-5533 www.liftmoore.com	DRAWN BY: JE DATE: 6/29/11	DRAWING NO. 50801-C
	SCHEM, HYD PROPORTIONAL LIFTMOORE.-MANIFOLD 24993		

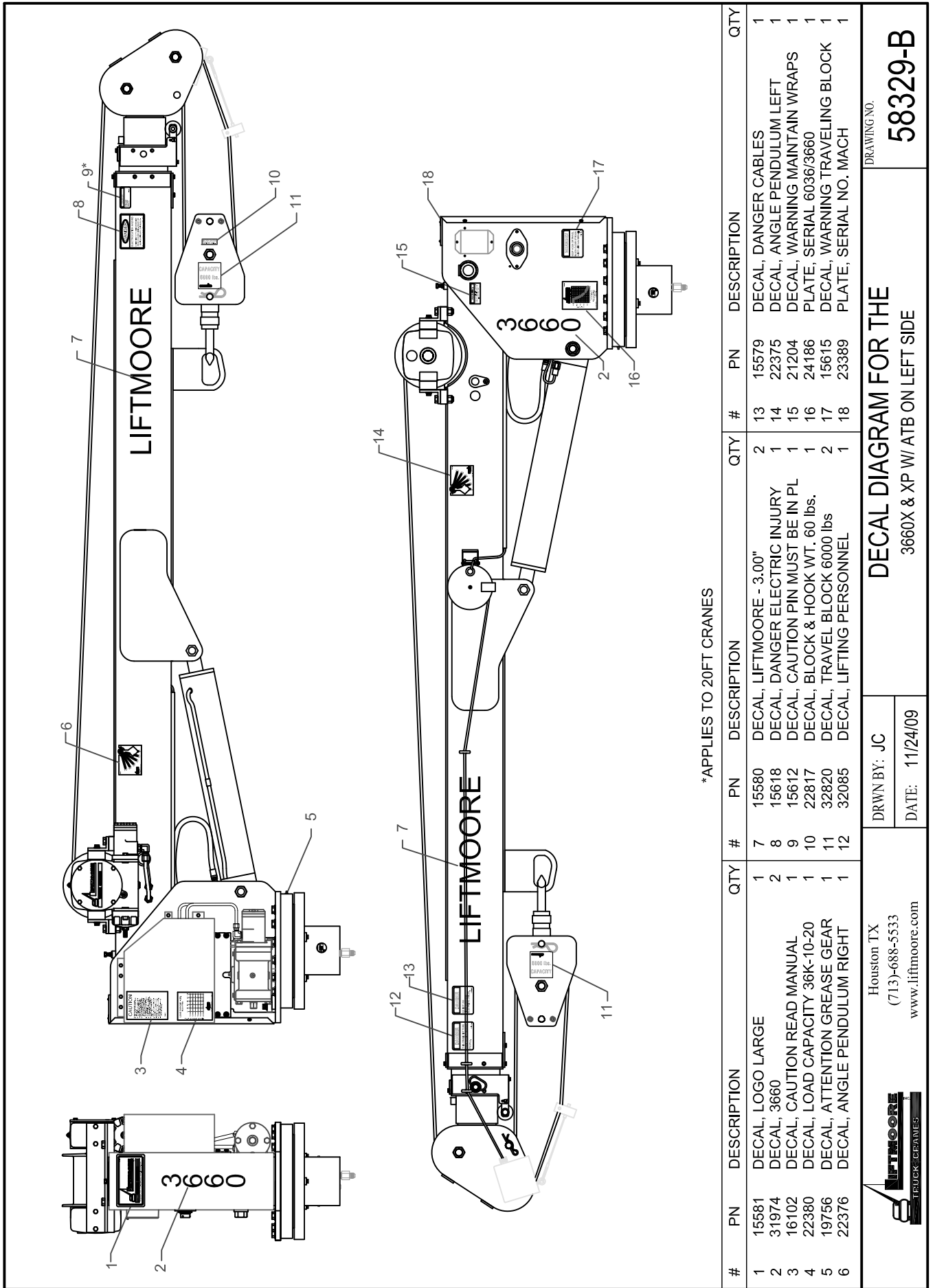

* APPLIES TO 20FT CRANES

#	PN	DESCRIPTION	QTY	#	PN	DESCRIPTION	QTY	#	PN	DESCRIPTION	QTY
1	15581	DECAL, LOGO LARGE	1	7	15580	DECAL, LIFTMOORE - 3.00"	2	13	15579	DECAL, DANGER CABLES	1
2	31974	DECAL, 3660	2	8	15618	DECAL, DANGER ELECTRIC INJURY	1	14	22375	DECAL, ANGLE PENDULUM LEFT	1
3	16102	DECAL, CAUTION READ MANUAL	1	9	15612	DECAL, CAUTION PIN MUST BE IN PL	1	15	21204	DECAL, WARNING MAINTAIN WRAPS	1
4	22380	DECAL, LOAD CAPACITY 36K-10-20	1	10	22817	DECAL, BLOCK & HOOK WT. 60 lbs.	1	16	24186	PLATE, SERIAL 6036/3660	1
5	19756	DECAL, ATTENTION GREASE GEAR	1	11	32820	DECAL, TRAVEL BLOCK 6000 lbs	2	17	15615	DECAL, WARNING TRAVELING BLOCK	1
6	22376	DECAL, ANGLE PENDULUM RIGHT	1	12	32085	DECAL, LIFTING PERSONNEL	1	18	23389	PLATE, SERIAL NO. MACH	1

Houston TX
(713)-688-5533
www.liftmoore.com

DRWN BY: JC
DATE: 11/24/09

DECAL DIAGRAM FOR THE
3660X & XP W/ ATB ON LEFT SIDE

DRAWING NO.
58329-B



3RD GENERATION RELAY BOARD	
Pin No.	Description
1	Ground
2	Trigger Signal Input
3	Proportional Valve Output
4	Pressure Switch Input
5	ATB Switch Input
6	Winch Up Switch Input
7	Elevation Down Switch Input
8	Extension Out Switch Input
9	Extension Out Output
10	Elevation Down Output
11	Winch Up Output
12	Supply (9 To 30 VDC)

ERROR CODE CHART

ERROR CODE COUNT	PROBABLE CAUSE
1	No Input To ATB Switch Input
2	No Input To Pressure Switch Input Or Overload Condition
3	Short Or Overload To Winch Up Output
4	Short Or Overload To Elevation Down Output
5	Short Or Overload To Extension Out Output
6	Trigger Input Out Of Range

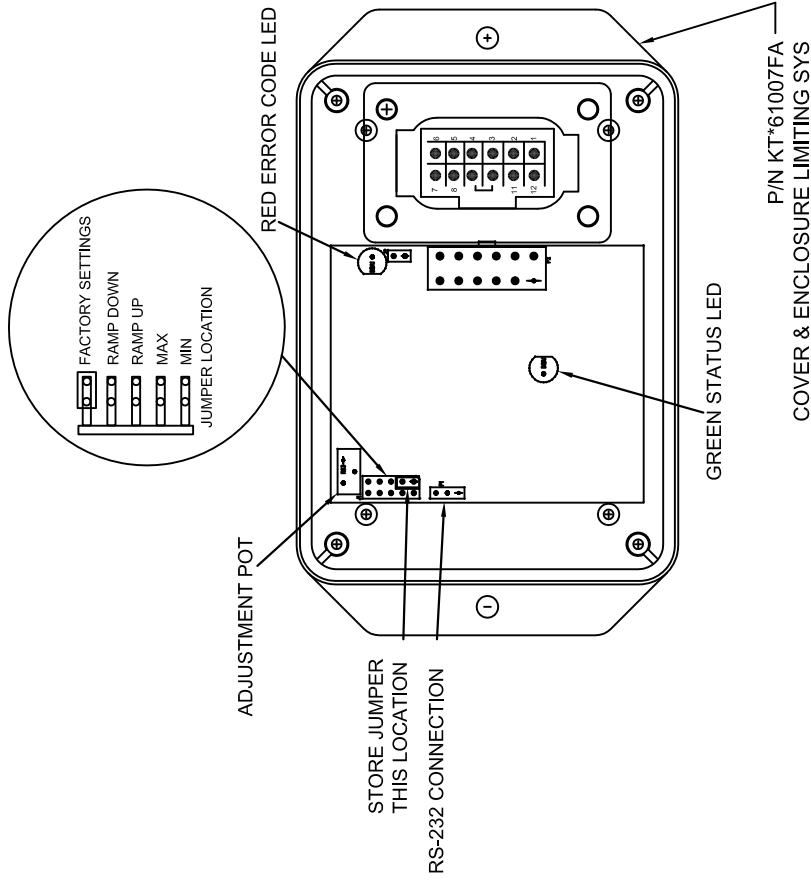

To Display an error code, the controller turns on and off the error code LED a certain number of times with a pause at the end. It repeats the code until the problem is resolved. The **Error Code Chart** is provided to assist the service personnel in troubleshooting the system.



Houston TX
(713)-688-5533
www.liftmoore.com

DRWN BY: JC

DATE: 06/11/07

BOARD, RELAY 3RD G XP ATB-BD

ATB DOES NOT STOP BOOM DOWN

DRAWING NO.

22569-C

THIS DRAWING INTENTIONALLY LEFT BLANK

FOR FUTURE ADDITIONS

OR

A PART OR FEATURE IS NOT APPLICABLE TO THIS CRANE



Houston TX
(713)-688-5533
www.iftmoore.com

DRWN BY:

DATE:

DRAWING NO.

LIFTMOORE LIMITED WARRANTY

Parts and Structural

Liftmoore, Inc. warrants each LIFTMOORE crane to be free from defects in materials and workmanship for twelve (12) months from the date of delivery to the original customer. Under the terms of this warranty the crane structural components manufactured by LIFTMOORE, Inc. are warranted for thirty-six (36) months from the date of delivery to the original customer. LIFTMOORE, Inc. will repair or replace, as its sole discretion, any equipment or part that is returned f.o.b. to LIFTMOORE, Inc.'s plant at 7810 Pinemont Drive, Houston, Texas 77040, or to one of its authorized dealers, and is found by LIFTMOORE, Inc. or its authorized dealer to have been defective at the time of original delivery.

The foregoing warranty is the exclusive warranty made by LIFTMOORE, Inc. with respect to its cranes and is in lieu of all other warranties. ANY AND ALL OTHER WARRANTIES, EXPRESS OR IMPLIED, INCLUDING ANY WARRANTY OF MERCHANTABILITY OR FITNESS OF ANY CRANE FOR A PARTICULAR PURPOSE OR OPERATION, ARE HERBY EXPRESSLY DISCLAIMED.

The foregoing warranty applies only to LIFTMOORE cranes under normal use and service and does not apply in the event of damage caused by repair or alteration or damage during shipment, accident, negligence, overloading, or misuse, including operator's failure to follow any of the instructions issued with the crane.

This warranty is limited to the original purchaser and is not assignable. In order to submit a claim, the original purchaser must provide a copy of the original invoice for the crane in question within twelve (12) months following the delivery date and within 30 days from the date of repair.

The warranty applies only when the LIFTMOORE crane is used for commercial purposes and does not cover any purchase for use for personal, family or household purposes.

LIMITATION OF LIABILITY: LIFTMOORE, Inc.'s liability for any losses or damages resulting from any cause whatsoever, including LIFTMOORE, Inc.'s NEGLIGENCE or from a defective crane irrespective of whether such defects are discoverable or latent, shall in no event exceed the purchase price of the crane to which losses or damages are claimed, or at the election of LIFTMOORE, Inc., the repair or replacement of the defective crane.

In no event shall LIFTMOORE, Inc. be liable for any special, incidental, or consequential damages, including commercial losses or costs of any kind sustained by purchaser or any other person or for any damages for which purchaser may be liable to other persons by reason of any defect in any LIFTMOORE crane or any part thereof.

LIFTMOORE, Inc. reserves the right to make changes in design or construction of its cranes at any time without obligating itself to make such changes on cranes previously manufactured.

No agent, employee, or representative of LIFTMOORE, Inc. has authority to amend or modify the foregoing warranty or to bind LIFTMOORE, Inc. by any other warranty, guaranty, or assumption of liability.

In the event any provision of this warranty is for any reason held ineffective, the remaining provisions shall remain in full force and effect.

Some states do not allow limitations on how long an implied warranty lasts or the exclusion or limitation of incidental or consequential damages, so the above limitations and exclusions may not apply to you. This warranty gives you specific legal rights, and you may also have other legal rights that vary from state to state.

