

TABLE OF CONTENTS

USERS MANUAL P/N 28216

L-8 OFFSET PEDESTAL

SECTION I GENERAL OPERATION, INSPECTION, AND MAINTENANCE

CRANE SAFETY RULES.....	F1122-B.....	1-1
INTRODUCTION	F1111-D.....	1-3
OPERATING RESTRICTIONS	F1495-0.....	1-4
OPERATING PRACTICES.....	F1495-0.....	1-4
INSPECTION AND MAINTENANCE.....	F1483-0.....	1-7
MONTHLY INSPECTION REPORT	F1496-0.....	1-8

SECTION II CRANE SYSTEMS AND TROUBLESHOOTING

CRANE OPERATION.....	F1485-A.....	2-1
MANUAL FUNCTIONS.....	F1497-0.....	2-2

SECTION III CRANE SPECIFICATIONS

LIFTING CAPACITIES	F1644-0.....	3-1
BOLT SPECIFICATIONS	F1644-0.....	3-2

SECTION IV PARTS

BOX PARTS LIST.....	F2446-0.....	4-1
CRANE ASSEMBLY	DWG.28214-A.....	4-2
PENDANT CONTROL	DWG.30448-A.....	4-3
BOOM ASSEMBLY	DWG.23483-0.....	4-4
WINCH DC-800 BREAKDOWN DRAWING.....	DWG.23231-0.....	4-5
WINCH DC-800 PARTS LIST I.....	DWG.23231-0.....	4-6
WINCH DC-800 PARTS LIST II	DWG.23231-0.....	4-7
BASE HOUSING	DWG.28213-0.....	4-8
CONTACTOR BOX ASSEMBLY.....	DWG.23471-C.....	4-9
ELECTRICAL SCHEMATIC.....	DWG.50762-0.....	4-10
DECAL DIAGRAM	DWG.58374-A.....	4-11

WARRANTY	F1442-A.....	
----------------	--------------	--



F2445-0
9/30/16

HOUSTON, TEXAS
FAX: (800) 824-5559 (USA & Canada)
FAX: (713) 688-6324
PHONE: (713) 688-5533
www.liftmore.com

THIS PAGE INTENTIONALLY LEFT BLANK



HOUSTON, TEXAS
FAX: (800) 824-5559 (USA & Canada)
FAX: (713) 688-6324
PHONE: (713) 688-5533
www.liftmoore.com

CRANE SAFETY RULES

CAUTION!

1. READ AND UNDERSTAND OPERATOR'S MANUAL.
2. INSPECT VEHICLE AND CRANE, INCLUDING ITS OPERATION BEFORE DAILY USE.
3. USE THIS EQUIPMENT ONLY ON SOLID LEVEL GROUND WITH OUTRIGGERS OR JACKSTANDS PROPERLY SET.
4. BEFORE OPERATING THE CRANE REFER TO MAXIMUM LOAD CHART ON CRANE FOR OPERATING LOAD LIMITS.
5. BE SURE LOAD BEING LIFTED IS WITHIN SAFE WINCH CAPACITY AS WELL AS SAFE CRANE CAPACITY. MULTI-PART LINE OPERATION IS REQUIRED WHEN SINGLE LINE LOAD CAPACITY OF WINCH IS EXCEEDED.
6. DO NOT OPERATE, WALK, OR STAND UNDER THE BOOM OR ANY SUSPENDED LOAD.
7. ALWAYS PAY OUT LOAD LINE BEFORE EXTENDING BOOM. WIRE ROPE DAMAGE AND / OR BREAKAGE MAY OCCUR.
8. BOOM MUST BE IN ITS REST BEFORE MOVING VEHICLE.
9. BOOM TIP MUST BE DIRECTLY OVER THE LOAD BEFORE ANY LIFTING IS STARTED. DO NOT DRAG LOADS WITH THIS CRANE.
10. MAINTAIN THIS CRANE AS REQUIRED IN THE OWNER'S MANUAL.
11. DO NOT ALLOW PERSONNEL TO RIDE ON THE LOAD LINE, LOAD, OR BOOM OF THIS CRANE.
12. IT IS UNLAWFUL TO OPERATE THIS EQUIPMENT WITHIN TEN FEET OF HIGH VOLTAGE LINE



THIS PAGE INTENTIONALLY LEFT BLANK



F1122-B
05/12/08

HOUSTON, TEXAS
FAX: (800) 824-5559 (USA & Canada)
FAX: (713) 688-6324
PHONE: (713) 688-5533
www.liftmore.com

THIS PAGE INTENTIONALLY LEFT BLANK



F1122-B
05/12/08

HOUSTON, TEXAS
FAX: (800) 824-5559 (USA & Canada)
FAX: (713) 688-6324
PHONE: (713) 688-5533
www.liftmoore.com

INTRODUCTION

This crane is a powerful machine designed to lift and move heavy loads. There are many hazards associated with these operations. Liftmoore has designed this crane to be as safe as possible but -

IT IS THE OPERATOR'S RESPONSIBILITY TO PREVENT ACCIDENTS!

This takes pre-planning, attention, and knowledge of basic principles and rules. Even if you have used similar cranes, reading this manual in its entirety will help prevent damage, injury, or even loss of life; benefits well worth the short amount of time it takes to read these pages.

REGULATORY AUTHORITY

Use of this crane is governed by OSHA 29 CFR 1910.180 and may be governed by other federal, state, or local regulations.

IT IS THE OPERATOR'S RESPONSIBILITY TO UNDERSTAND AND COMPLY WITH ALL APPLICABLE REGULATIONS GOVERNING THE OPERATION, INSPECTION, AND MAINTENANCE OF THIS CRANE.

Personnel should be trained, tested, and certified, as recommended by OSHA and ANSI standards, before operating this crane.

USING THIS MANUAL

This manual assumes that the crane is mounted on a typical service body type or similar truck, which is powered by the vehicle electrical or hydraulic system, and is controlled by either the standard pendant control or FM radio control sold by Liftmoore, Inc.

This manual is supplied to provide basic guidelines for the safe use, routine maintenance, and general inspections of this crane.

This manual is supplied to provide basic guidelines for the safe use, routine maintenance, and general inspections of this crane.

Laws, regulations, standards, or policies may be more restrictive than this manual. If a conflict exists for any limit or condition, the safest or most prohibitive shall be used. Under no circumstances shall the load, moment, or stability ratings be exceeded.

Pay particular attention to the following:

WARNING! – Draws attention to hazards, conditions, or procedures that if not observed could result in injury or death.

CAUTION! – Draws attention to hazards, conditions, or procedures that if not observed could result in damage to the crane, load, or other equipment. Equipment failure could in turn lead to injury or death.

NOTE! – Draws attention to conditions or procedures that are essential to emphasize.

For questions, interpretations, or to report errors, please contact Liftmoore, Inc, Engineering Dept.



OPERATING RESTRICTIONS

DUTY CYCLE

For Electric Cranes the duty cycle time should be limited to 10%. This is limited by heat buildup in the motors and declining charge in the batteries. (Installing extra batteries near the crane helps keep the voltage at maximum.)

PERSONNEL

LIFTING OR MOVING OF PERSONNEL IS STRICTLY PROHIBITED! This crane was neither designed nor intended to lift personnel. Under no circumstances should anyone be allowed to ride on the crane, line, or load. All non-essential personnel must be kept away when using the crane. The load must never be moved over people, nor must anyone be allowed to pass or stand under a suspended load.

ELECTRICAL LINES

Consult ANSI B30.5 for operating procedures, minimum safe distances, and prohibited zones when working around electrical lines or poles.

When operating near electrical power lines, the crane must be positioned so that the distance from the crane to the lines or poles is equal to or greater than the length of the fully extended boom plus the minimum safe distance required.

All parts of the crane, line, and load must be kept a minimum safe distance from electrical power lines and poles. This distance is 10 feet for electrical lines carrying 50kV or less.

UNDER NO CIRCUMSTANCES SHOULD A CRANE BE OPERATED UNDER ELECTRICAL POWER LINES.

OPERATING PRACTICES

SETUP

POSITION The vehicle must be positioned so that the load is kept as close to the crane base as possible to reduce the moment on the crane. Consideration must be given to starting and ending position as well as firmness and slope of the ground and any obstructions.

OUTRIGGERS/JACKSTANDS The outriggers or jackstands must be firmly set and the vehicle as level as possible. This will reduce the stresses on the rotation drive and keep the load off the vehicle's suspension. Keep in mind that the weight on the vehicle will shift as the crane and load are rotated.

Set the vehicle's parking brake. The jackstand is inserted into the tube in the released position. Set the hitch pin so that the jackstand will lift the truck slightly when put into the locked position. When setting up the jackstand, it must be straight up and down. It must be in contact with a hard, unyielding surface. If necessary use a heavy timber to support the load on soft surfaces. When set, the vehicle should be as level as possible. It is advisable to set wheel chocks to hold the vehicle in position.

After loading the vehicle it may not be possible to remove the jackstand by releasing the handle. When this occurs the vehicle may be driven off the stand.

Use the jackstand on every load. Even a light load can cause considerable tilt when picked up at a large radius. Use the jackstand to keep the truck level.



WARNING!

LOAD LIMIT The operator must understand the crane load chart. The operator must ensure that the load is within the load limits over the entire range which it will be moved. Be sure to include the weight of any lifting devices including the travel block.

The load limit chart is attached to the side of the crane to aid the operator.

STABILITY The operator is responsible to verify that the truck is stable at any area where the Crane is rotated.

BOOM This crane has a fixed boom angle of approximately 20 degrees. The boom can only be extended manually from 3 Ft. to 5 Ft. with an intermediate stop at 4 Ft.. Make sure the hitch pin and its keeper is in place before attempting to lift a load. The boom length cannot be changed when a load is on the crane.

Wire Rope Ensure the proper routing of the rope through the sheaves and travel block. The rope must lie in the sheave groove and must not rub against any metal objects.

Ensure the rope is correctly wound on the winch drum. The crane assembly drawing will indicate if the rope must be wound over the top or bottom of the drum. The rope must never contact any part of the winch mounting.

Always keep a minimum of five wraps of wire rope on the drum at all times. With fewer wraps the wire rope could break loose from the drum under load.

Keep the cable straight and tight as it winds onto the winch drum. Do not wrap the wire rope around any loads.

If the winch winding direction is reversed the brake will not work and the load will fall.

ATTACHING THE LOAD

POSITION The boom tip must be moved over the load before lifting so that the load will be lifted straight up.

CAUTION!

Never drag a load with the crane. Dragging a load puts very high stresses on the crane for which it was not designed.

ROPE Check the rope condition to ensure it is not frayed or damaged. Ensure that the rope is not kinked and that it does not contact any sharp edges or make any sharp bends.

CAUTION!

Never wrap the hoist rope around the load! Serious damage to the rope WILL occur.

HOOK Always make sure the load is applied to the throat of the hook. Never use a bent hook.

CAUTION!

Always lift with the throat of the hook. Never lift with the load applied to the tip of the hook. Doing so will bend the hook.

SLINGS If the load does not have a lifting eye, use a nylon, chain, or other type of sling designed for lifting and rated for loads greater than that being lifted.



BALANCE Ensure the load will be secure and balanced when lifted. Ensure that the load cannot shift in the sling and that the sling cannot slide across the hook should the load become unbalanced.

LIFTING THE LOAD

Before lifting, ensure that the load is free from all mountings and is no way attached or stuck to anything.

Ensure that at least five full wraps remain on the winch drum at all times.

Test the winch brake by lifting the load a few inches and ensuring that it does not slip.

HOLDING THE LOAD

The operator must keep the load in sight at all times once it is lifted.

The operator must never leave the controls once the load is lifted.

The operator must ensure that no one is allowed to pass or stand under a suspended load.

CAUTION!

Never move the vehicle with a suspended load. Doing so will put dynamic loads on the crane for which it was not designed.

MOVING THE LOAD

If the truck is not level when a load is lifted on a Manual Rotation Crane, the load will gravitate to the lowest point. Caution must be taken to ensure the operator is not in a Pinch Position (on a downhill side of the lift point). The Manual Brake Band should be snug to help control the swing but still allow the load to be pushed around to the area where it is to be set down.

TRANSIT

While in transit, the crane must be stowed, preferably in a boom rest. The crane must be prevented from rotating and the hook prevented from swinging.



INSPECTION AND MAINTENANCE

OSHA and ANSI require frequent and periodic inspections. Records of these inspections must be kept readily available. Liftmoore requires periodic maintenance to ensure proper operation and prolonged life of the crane

INSPECTION

DAILY INSPECTION

The following items must be checked daily before the crane is put into use.

- All safety devices
- Rope for kinks or frayed wires
- Rope reeving
- Hooks for 15% increase in throat opening or bent (twisted) more than 10° out of plane
- All bolts are in place and tight
- All hitch pins are in place

PERIODIC INSPECTION

A Monthly Inspection Report form is included in this manual. It is provided to assist in compliance with OSHA and ANSI inspection standards. These publications should be checked periodically for updates.

MAINTENANCE PRECAUTIONS

Before any maintenance is performed, the vehicle should be out of the way and the crane secured.

WARNING!

Never perform any maintenance while the crane has any type of load on it.

BOLTS Bolts may loosen over time due to vibration, therefore they should be checked periodically. If bolts need to be replaced, make sure they are replaced with bolts of equal or greater strength. Check the periodic maintenance schedule (Crane Specification Section) for bolt specification and torque.

NOTE!

Sheave bolts are not standard bolts. The shank and thread lengths of these bolts have been modified so that they do not pivot on the threads. Consult the parts section of this manual for part numbers of these bolts.



MONTHLY INSPECTION REPORT
Manual Boom Extension L-15

Crane Model No. _____ **Serial Number** _____

- Are Boom Hitch Pins and Keepers in place? Yes _____ No _____
- Wire Line Hook with Safety Latch Working? Yes _____ No _____
- Is Hook OK, (Not bent)? Yes _____ No _____
- Is Thimble on Wire Rope OK? Yes _____ No _____
- Is Wire Rope OK, not kinked or frayed? Yes _____ No _____
- Are all Boom Sections straight? Yes _____ No _____
- Are Sheave Bolts in place and tight? Yes _____ No _____
- Do all Sheaves rotate easily? Yes _____ No _____
- Are Mounting Bolts torqued correctly? Yes _____ No _____
- Are Boom Support Mounting Bolts secure? Yes _____ No _____
- Are Winch Mounting Bolts tight? Yes _____ No _____
- When stopped, does winch down drift less than 1.0 Inches? Yes _____ No _____
- Is Load Chart / Serial Plate in place and easily read? Yes _____ No _____
- Are functions on Pendant operating correctly? Yes _____ No _____
- Is Outrigger or jackstand straight and functioning? Yes _____ No _____





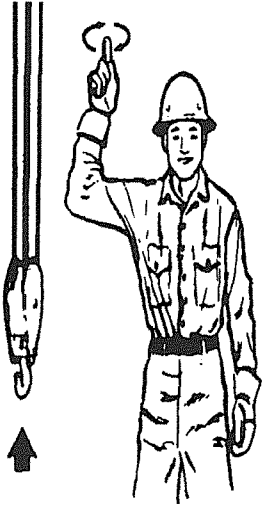
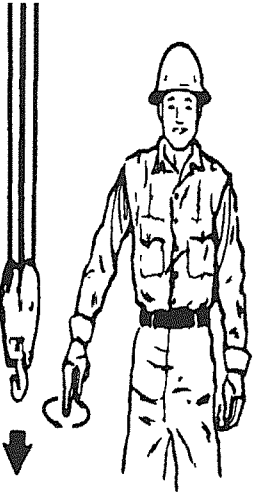
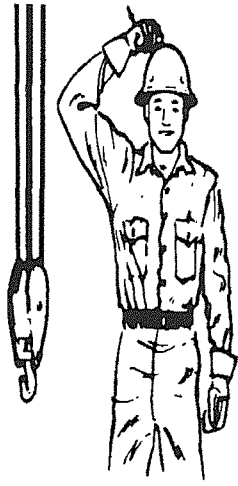
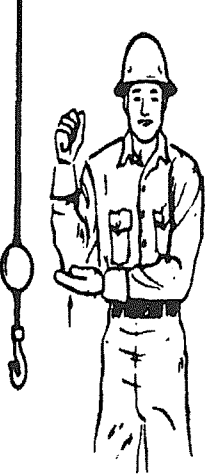
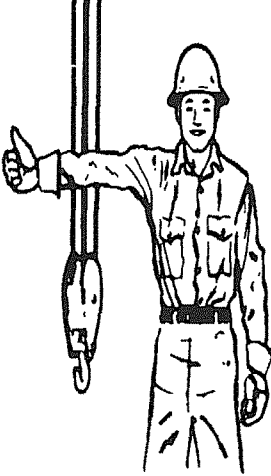
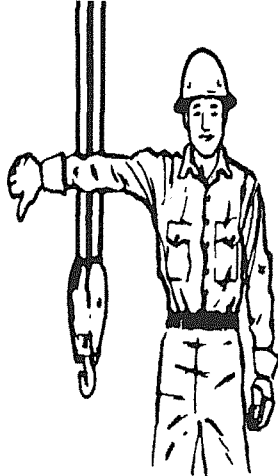

Any items checked 'No' must be repaired before using this crane.

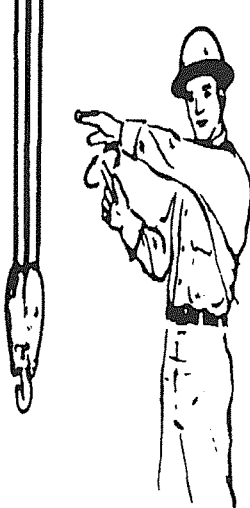
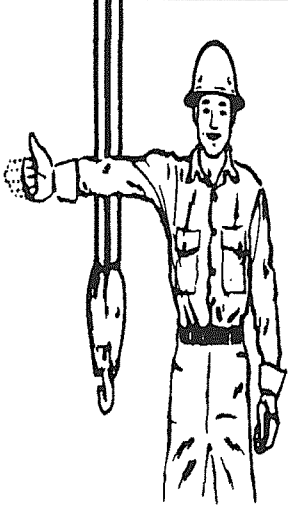
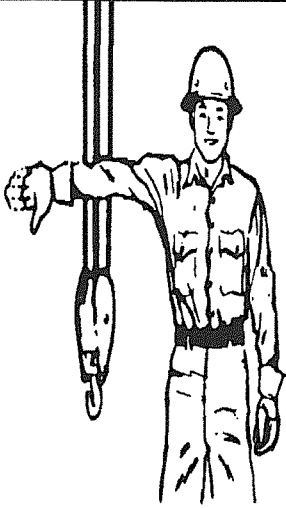
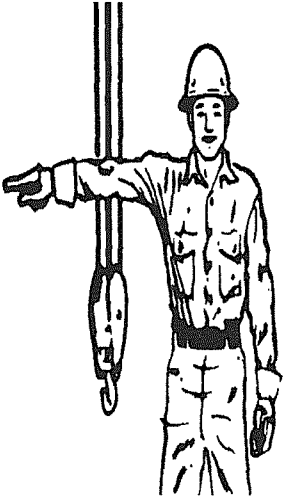
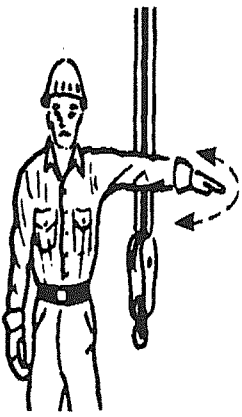
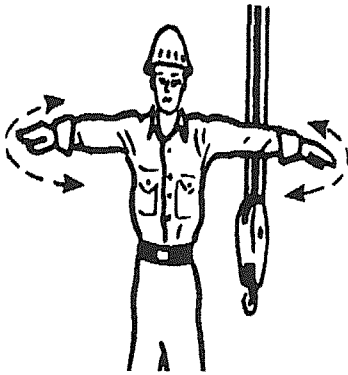

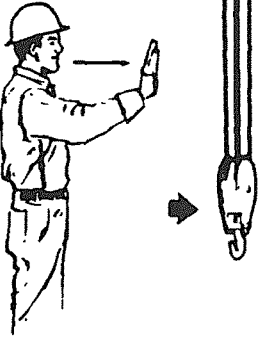
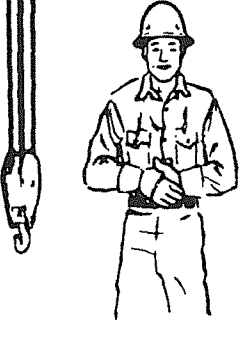
STANDARD HAND SIGNALS FOR CONTROLLING CRANE OPERATIONS

 <p>HOIST. With forearm vertical, forefinger pointing up, move hand in small horizontal circle.</p>	 <p>LOWER. With arm extended downward, forefinger pointing down, move hand in small horizontal circle.</p>	 <p>USE MAIN HOIST. Tap fist on head; then use regular signals.</p>
 <p>USE WHIPLINE (Auxiliary Hoist). Tap elbow with one hand; then use regular signals.</p>	 <p>RAISE BOOM. Arm extended, fingers closed, thumb pointing upward.</p>	 <p>LOWER BOOM. Arm extended, fingers closed, thumb pointing downward.</p>

 <p>MOVE SLOWLY. Use one hand to give any motion signal and place other hand motionless in front of hand giving the motion signal. (Hoist slowly shown as example.)</p>	 <p>RAISE THE BOOM AND LOWER THE LOAD. With arm extended, thumb pointing up, flex fingers in and out as long as load movement is desired.</p>	 <p>LOWER THE BOOM AND RAISE THE LOAD. With arm extended, thumb pointing down, flex fingers in and out as long as load movement is desired.</p>
 <p>SWING. Arm extended, point with finger in direction of swing of boom.</p>	 <p>STOP. Arm extended, palm down, move arm back and forth horizontally.</p>	 <p>EMERGENCY STOP. Both arms extended, palms down, move arms back and forth horizontally.</p>

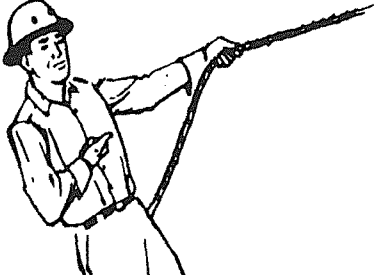
 <p>TRAVEL. Arm extended forward, hand open and slightly raised, make pushing motion in direction of travel.</p>	 <p>DOG EVERYTHING. Clasp hands in front of body.</p>	 <p>TRAVEL (Both Tracks). Use both fists in front of body, making a circular motion about each other, indicating direction of travel, forward or backward. (For land cranes only.)</p>
 <p>TRAVEL (One Track) Lock the track on side indicated by raised fist. Travel opposite track in direction indicated by circular motion of other fist, rotated vertically in front of body. (For land cranes only.)</p>	 <p>EXTEND BOOM (Telescoping Booms). Both fists in front of body with thumbs pointing outward.</p>	 <p>RETRACT BOOM (Telescoping Booms). Both fists in front of body with thumbs pointing toward each other.</p>
 <p>EXTEND BOOM (Telescoping Boom). One Hand Signal. One fist in front of chest with thumb tapping chest.</p>		 <p>RETRACT BOOM (Telescoping Boom). One Hand Signal. One fist in front of chest, thumb pointing outward and heel of fist tapping chest.</p>

THIS PAGE INTENTIONALLY LEFT BLANK



CRANE OPERATION

Hoist Winch Only

PENDANT CONTROL

All user inputs are facilitated by the remote pendant control. The pendant control plug mates with the crane control socket and controls the hoist and other functions.

OPERATION

Raise the cover on the crane control socket and plug in the pendant. Ensure all pins are straight and free of dirt, moisture, and corrosion.

NOTE!

The control socket cover locks the plug in the socket and must be lifted to unplug the pendant.

CARE AND MAINTENANCE

The pendant control is designed to be as rugged and maintenance free as possible; however, care should be used in handling and storage as it is expensive to replace.

Follow these simple practices:

- Keep the pendant out of the weather
- When not in use, store the pendant inside the vehicle
- Do not wrap the wire too tightly as internal damage to the wires may result
- Do not place sharp or heavy objects on the cord

NOTE!

The pendant is designed to be weatherproof not waterproof. It may be used in inclement weather, but if left outside or where water can puddle, water can seep inside.

Maintenance should be limited to routine inspection of the plug, wire, and fasteners.

SAFETY SYSTEM

This crane does not have a load limiting or ATB safety system.

It is the operator's responsibility to understand and strictly adhere to the load limits of the crane. The operator must also know the weight of any objects to be lifted.

The operator must always be aware of the hook and travel block position and ensure that the crane is never two-blocked (allowing the travel block or hook to contact the crown plate.)

ELECTRICAL SYSTEM

This crane is powered by the vehicle electric system.

CIRCUIT BREAKER

A circuit breaker is supplied with the crane and should be installed as close to the battery as possible.

QUICK DISCONNECT

A quick disconnect is provided. This plug will disconnect the crane from the vehicle's batteries. It should be separated whenever the crane is not in use. Disconnecting this plug will prevent unauthorized use or inadvertent operation of the crane. To disconnect the plug, line up the arrows on the plug and pull it apart. Power should be disconnected whenever the crane is not in use to prevent unauthorized use or inadvertent operation of the crane. When the power cord is connected, the solenoids are connected directly to the battery and the crane can run if objects come in contact with the solenoid post and the power is not off.



MANUAL FUNCTIONS

Care should be used when maneuvering loads into and out of the vehicle. Do not raise loads higher than is needed to get the load into or out of the vehicle.

EXTENSION

The boom may be manually extended as needed. The boom must be set to the desired length before lifting the load. A boom stop is provided to prevent the inner boom from being inadvertently removed from the outer boom.

CAUTION!

All boom pins must be in place before lifting the load. The boom stop will not support a load. If proper boom pins are not installed the boom may collapse under load causing serious damage and possible injury or death.

ROTATION

The crane must be rotated manually. Tapered roller bearings are utilized to reduce the force required.

CAUTION!

The force required to rotate the crane will increase dramatically if the truck is not level or if the load causes the truck to lean. Outriggers or jackstands **MUST** be used.

CAUTION!

Extreme caution must be used when rotating heavy loads. Even with the use of outriggers or jackstands the truck may tilt as the crane is rotated. Even a small lean may cause the load to become uncontrollable.

BRAKE

The crane is equipped with a hand tightened band brake to help control the load when rotating.

CAUTION!

Even with the brake tightened the load may become uncontrollable if the vehicle becomes unlevelled.

CAUTION!

The brake is not designed nor intended to hold the crane during transit. The crane must be held by a boom rest and/or tethered to the truck when not in use.



SECTION 3 CRANE SPECIFICATIONS

MODEL L-8 CRANES

MOMENT RATING 4 500 FT-LBS
 MAX SINGLE LINE LOAD 800 LBS

LIFTING CAPACITIES AT VARIOUS LOAD RADII:

LOAD RADIUS (FT)	CAPACITY (LBS)
3.8	800
4.7	800
5.6	800

The winch is factory lubricated and should not require further lubrication in its lifetime. The winch brake cannot be adjusted. If brake drift is more than 1 inch under full load then it must be replaced.

ELECTRICAL

VOLTAGE 12 VDC NOMINAL
 CIRCUIT BREAKER 150 AMP

MOUNTING BOLTS

½-13 GRADE 8 TORQUE 110 FT-LBS DRY
 CHECK TORQUE EVERY 4 MONTHS



F1644-0
 02/05/10

HOUSTON, TEXAS
 FAX: (800) 824-5559 (USA & Canada)
 FAX: (713) 688-6324
 PHONE: (713) 688-5533
 www.liftmoore.com

THIS PAGE INTENTIONALLY LEFT BLANK



F1644-0
02/05/10

HOUSTON, TEXAS
FAX: (800) 824-5559 (USA & Canada)
FAX: (713) 688-6324
PHONE: (713) 688-5533
www.liftmoore.com

LIST FOR BOX, CRANE PARTS L-8

Items with * have detailed DWG's.

P/N 28215 - BOX, CRANE PARTS L-8

1)	P/N 28216 - MANUAL, CRANE L-8.....	1pc
2)	P/N 31022 - WIRE, 25' #4 AWG BATTERY.....	1pc
3)	P/N 30728 - WIRE, GROUND #4 X 3' LONG.....	1pc
4)	P/N 30760 - PIN, HITCH 0.75 X 4.50 W/H-PIN.....	1pc
5)	P/N 30815 - SCREW, HHC 0.50-13 X 2.50 GR8.....	4pcs
6)	P/N 30474 - WASHER, LOCK 0.50 GR5 PLATED.....	4pcs
7)	P/N 31957 - NUT, HEX 0.50-13 GR8 PLATED.....	4pcs
8)	P/N 16878 - BREAKER, CIRCUIT 150 AMP.....	1pc
9)	P/N 16922 - TERMINAL, LUG #4 GA 0.25 DIA.....	2pcs
10)	*P/N 30448 - CONTROL, PENDANT L-15 & L-21.....	1pc
11)	P/N 22797 - INSTALLATION INTS. L-21/21W/15.....	1pc
12)	P/N 23478 - PIN, HITCH 0.50 X 4.50 W/H-PIN.....	1pc
13)	P/N 23487 - DECAL, LOAD CAPACITY L-8.....	1pc



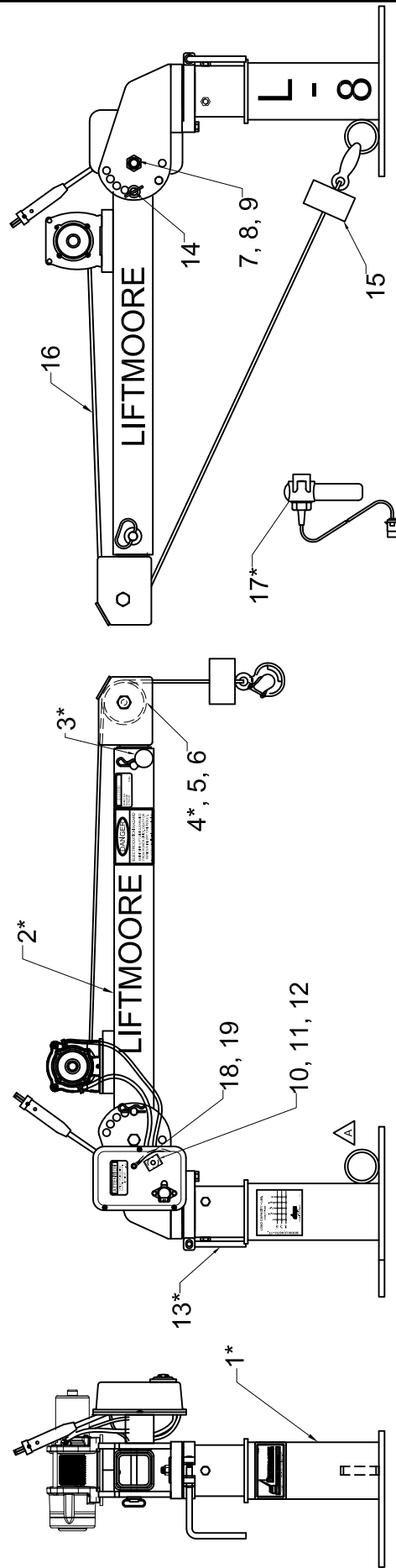

ITEMS WITH * HAVE DETAIL DRAWINGS

#	PN	DESCRIPTION	QTY	#	PN	DESCRIPTION	QTY	#	PN	DESCRIPTION	QTY
1	28213	BASE-HOUSING ASSEMBLY L-8	1	9	19323	WASHER, FLAT 0.50 SAE GR8	1	17	30448	CONTROL, PENDANT L-15 & L-21	1
2	23483	BOOM ASSEMBLY L-8	1	10	15789	CLAMP, HALVES 2 STL HYD TUBE	1	18	30809	SCREW, HHC 0.25-20 X 0.50 GR5	1
3	31036	STOP, BOOM INNER ASSY STD.	1	11	30457	SCREW, HHC 0.25-20 X 0.75 GR5	1	19	30889	WASHER, LOCK 0.25 GR5 PLATED	1
4	32642	SHEAVE ASSY 3.50PD X 0.25 ROPE	1	12	31110	WASHER, FLAT 0.25 GR5 PLATED	1	NOT SHOWN:			
5	30500	SCREW, HHC 0.50-13 X 2.25 GR8	1	13	31051	HANDLE, BRAKE L-15	1	23488	DECAL KIT L-8	1	
6	30835	NUT, HEX NYLOC 0.50-13 GRADE 5	1	14	23734	PIN, HITCH 0.625 X 4.50 W/H-PIN	1	23486	PLATE, SERIAL L-8	1	
7	30817	SCREW, HHC 0.50-13 X 6.00 GR8	1	15	27135	PICKLE (WEIGHT)	1				
8	30835	NUT, HEX NYLOC 0.50-13 GRADE 5	1	16	30446	ROPE, WIRE 0.18 X 25' W/THB&HK	1				

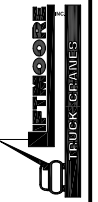

Houston TX
(713)-688-5533
www.liftmoore.com

DRWN BY: JE

DATE: 9/30/16

CRANE ASSY L-8 SPECIAL

OFFSET PEDESTAL

DRAWING NO.

28214-A

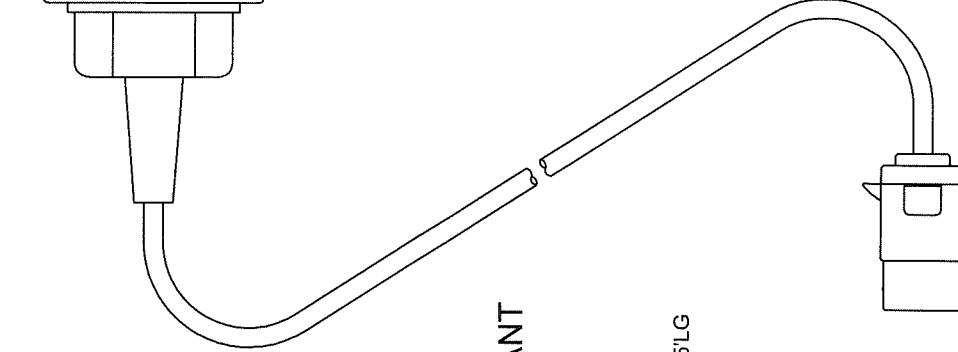
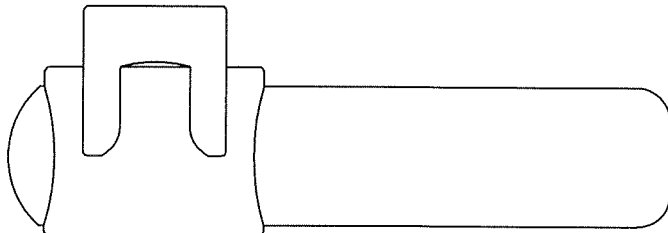
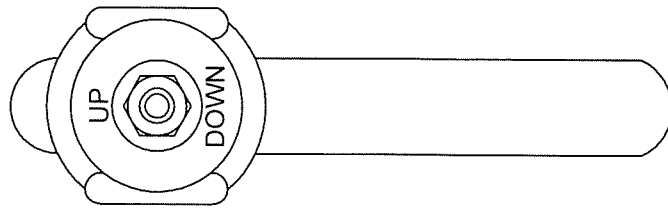

COMPLETE PENDANT

P/N 30448 CONTROL, PENDANT L-15 & L-21

PENDANT, LESS PLUG

P/N 15129 CONTROL, PENDANT BLANK 12.5'LG

REPLACEMENT PLUG

P/N 30908 PLUG, CONTROL 4-PIN

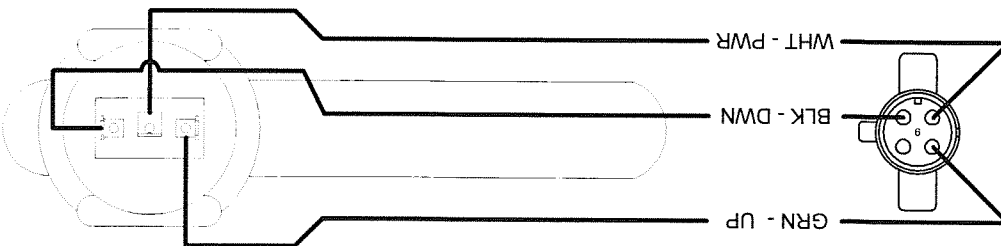

FRONT VIEW



Houston TX
(713)-688-5533
www.liftmoore.com

DRWN BY: JC
DATE: 04/24/08

CONTROL, PENDANT L-15 & L-21
12.5 FT. W/ PLUG & BOOT

DRAWING NO.

30448-A

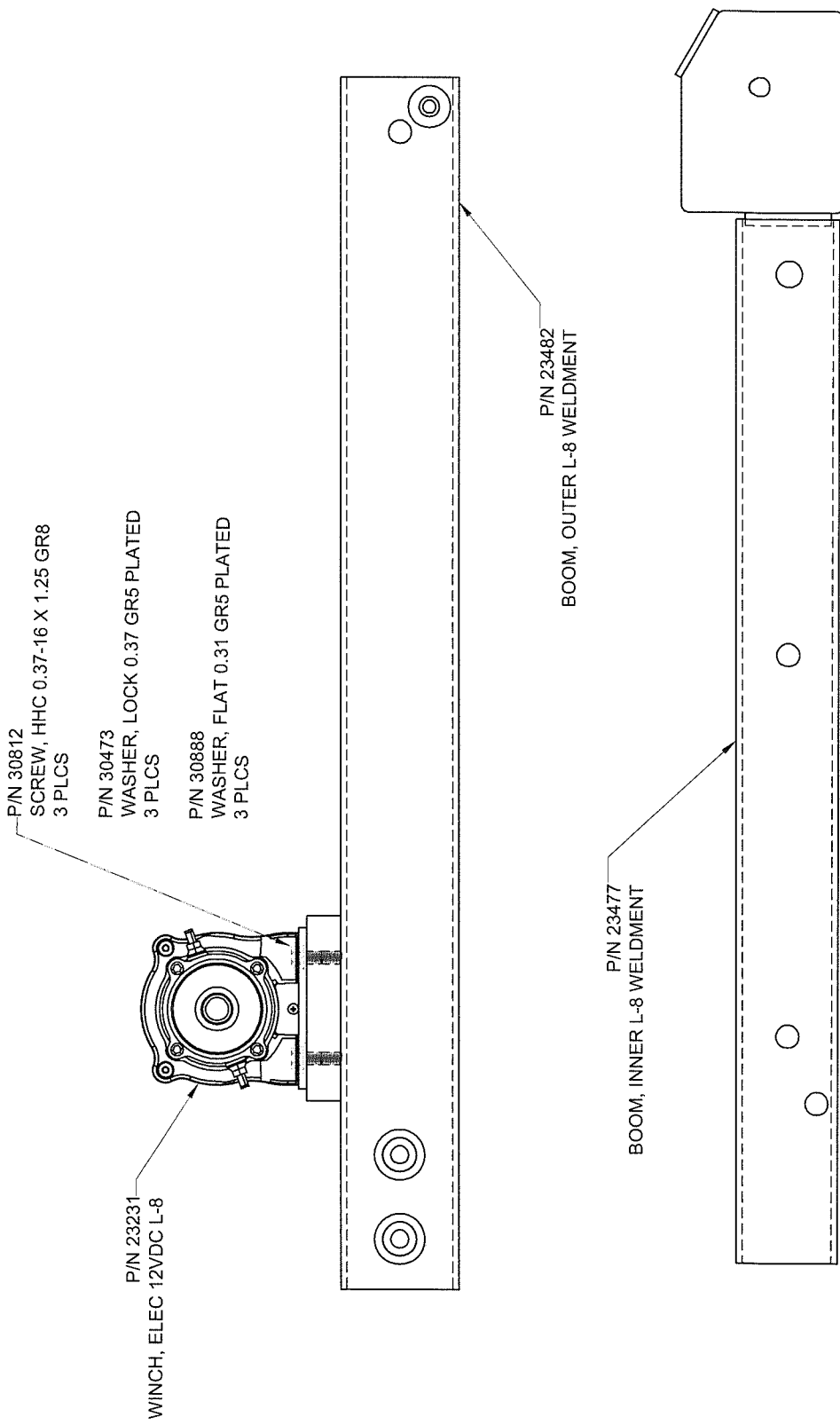

	Houston TX (713)-688-5533 www.iftmoore.com	DRWN BY: KSP DATE: 2/1/10	BOOM ASSEMBLY L-8 W/ WARN WINCH P/N 23231	DRAWING NO. 23483-0
---	--	------------------------------	--	-------------------------------

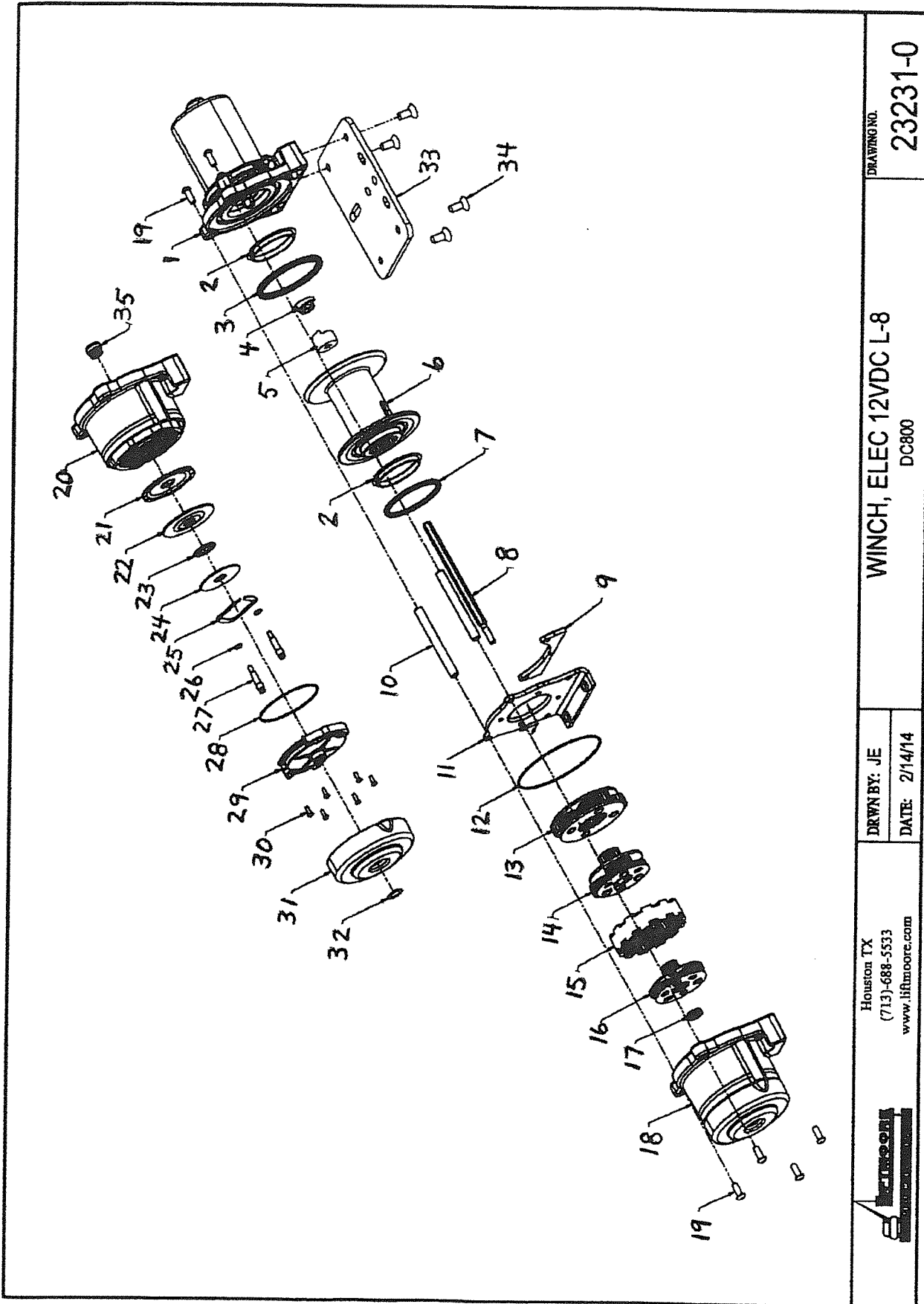

Houston, TX
(713)-688-5533
www.liftmoore.com

DRAWN BY: JE
DATE: 2/14/14

WINCH, ELEC 12VDC L-8
DC800

DRAWING NO. 23231-0

 BY: JE
 DATE: 2/14/14

 WINCH ELECTRIC 12VDC
 PARTS LIST

DOCUMENT NO.

23231-0

Service Part Kit List: DC800 Hoist-12V

Item Reference	Description	Item/Kit No.
1	MOTOR, CAN, SEALED, 3 IN, JOHNSON	73900
2	BUSHING, DRUM, A2000	69637
6	DRUM, GROOVED, ALUM, WNCH, ATV	74922
8	SHAFT, DRIVE, WINCH, HEX	74997
13	CARRIER ASSY, STAGE 3, 2.5	75005
14	CARRIER ASSY, STAGE 2, 2.5	75004
15	GEAR, RING, PM, ODC, 2.5	74918
16	CARRIER ASSY, STAGE 1, 2.5	75002
17	GEAR, SUN, 12T, S1	74999
18	HOUSING ASSY, RT25, CLUTCHLESS	82134
29	CAP, CLUTCH, WINCH, ATV	79594
	WINCH SEAL KIT	74925
3	SEAL, DRUM, FLANGE X-RING, R WN (Qty. 1)	
7	SEAL, GEAR-SIDE, DRUM, X-RING (Qty. 1)	
12	SEAL O-RING 4.05IN NBR 70A YELLOW (Qty.1)	
26	SEAL, RING, QUAD, 1/4 IN (Qty. 2)	
28	SEAL O-RING 2.8IN NBR 70A YELLOW (Qty. 1)	
	WINCH MOTOR COUPLER KIT	74995
4	COUPLER, CAM, MOTOR, 12MM (Qty. 1)	
5	COUPLER, FOLLOWER, HEX, WINCH (Qty. 1)	
	WINCH TIE ROD KIT	74920
10	TIE ROD, METRIC, TAPD, 3.5" PLATED (Qty. 2)	
19	CPSCR, BTN HD, M6-1.0X16, ZN (Qty. 4)	
	WNCH DRUM SUPPORT KIT	74917
9	PLATE, PROTECTOR, WIRE ROPE (Qty. 1)	
11	DRUM SUPPORT, GS, 2.5 (Qty. 1)	
19	CPSCR, BTN HD, M6-1.0X16, ZN (Qty. 2)	
	HOUSING ASSY, RT25, CLUTCHLESS	82134
20	HOUSING, GEAR, WINCH, ATV, MACHINED (Qty. 1)	
21	PLATE RETAINING BRAKE RT/XT SLOTTED (Qty. 1)	
22	DISC BRAKE WINCH RT/XT (Qty. 1)	
23	BEARING ROLLER THRUST 15mm (Qty. 1)	
24	WASHER THRUST ID 15.24mm (Qty. 1)	
25	SPRING BRAKE WAVE ATV WINCH (Qty. 1)	
26	SEAL, RING, QUAD, 1/4 IN (Qty. 2)	

LIFTMOORE INC

HOUSTON TX 77040

(713) 688-5533



BY: JE
DATE: 2/14/14

WINCH ELECTRIC 12VDC
PARTS LIST

DOCUMENT NO.

23231-0

Item Reference	Description	Item/Kit No.
27	PIN, CLUTCH, SBC, WINCH (Qty. 2)	
28	SEAL O-RING 2.8IN NBR 70A YELLOW (Qty. 1)	
29	CAP, CLUTCH, WINCH, ATV (Qty. 1)	
30	CPSCR, 6 X 3/8, PLASTITE, BTN HD, TORX (Qty. 6)	
31	COVER END CLUTCH BLOCKED (Qty. 1)	
32	(VIMS) RING, RETAINING, INVERTED (Qty. 1)	
35	ROLLER CLUTCH ASSY WINCH RT/XT (Qty.1)	
	BRAKE KIT WINCH RT/XT	74923
21	PLATE RETAINING BRAKE RT/XT SLOTTED (Qty. 1)	
22	DISC BRAKE WINCH RT/XT (Qty. 1)	
23	BEARING ROLLER THRUST 15mm (Qty. 1)	
24	WASHER THRUST ID 15.24mm (Qty. 1)	
25	SPRING BRAKE WAVE ATV WINCH (Qty. 1)	
28	SEAL O-RING 2.8IN NBR 70A YELLOW (Qty. 1)	
	WINCH CLUTCH GROUP KIT	74926
27	PIN, CLUTCH, SBC, WINCH (Qty. 2)	
33	PLATE MTG RT30 INDUST (Qty. 1)	81879
34	CPSCR_ FLT HX HD_M8-1.25 X20MMZINC (Qty. 4)	75599
	LABEL DC800	82477
	LABEL WARNING MOTOR DC800	82479

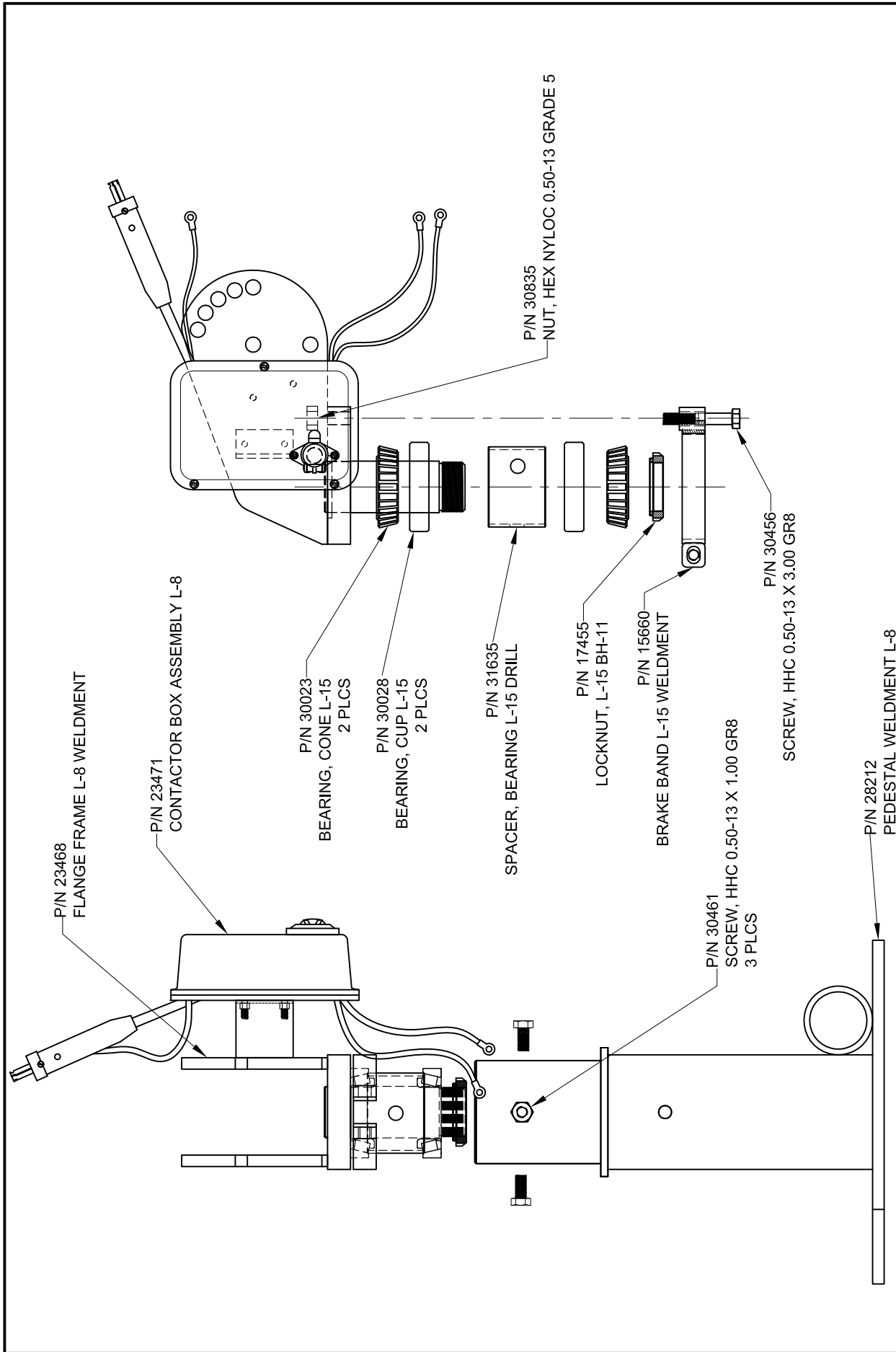

DRAWING NO.
28213-0

BASE-HOUSING ASSEMBLY L-8 SP
WARN WINCH, OFFSET PEDESTAL

DRWN BY: JE
DATE: 11/15/16

Houston TX
(713)-688-5533
www.liftmoore.com



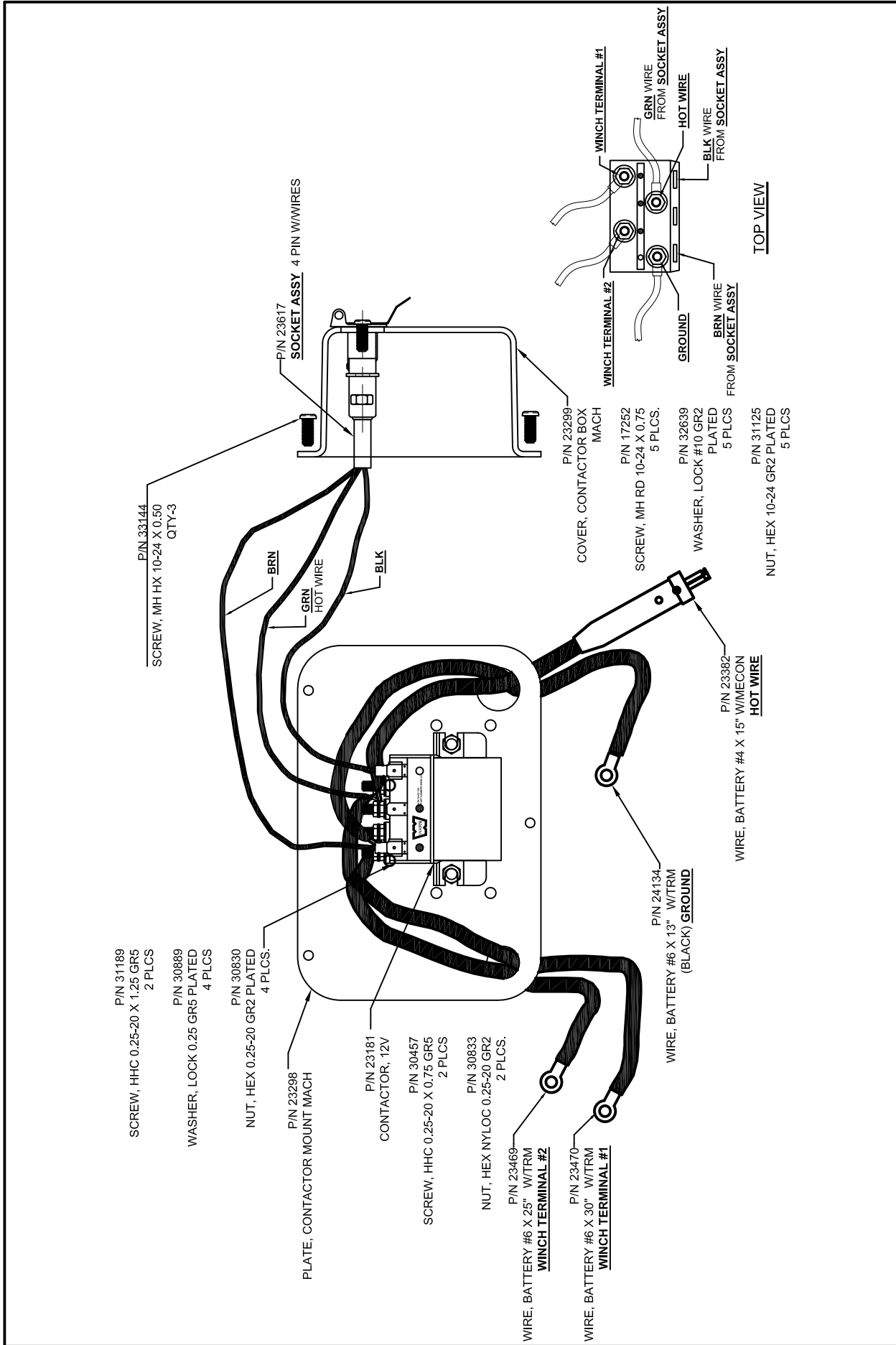

DRAWING NO.
23471-C

CONTACTOR BOX ASSEMBLY L-8
W/ WARN CONTACTOR

DRWN BY: KSP
DATE: 1/30/10

Houston TX
(713)-688-5533
www.liftmoore.com



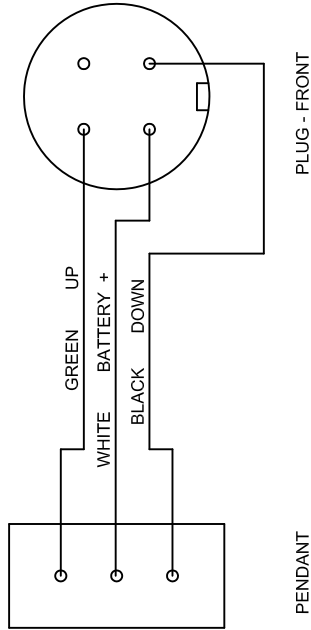
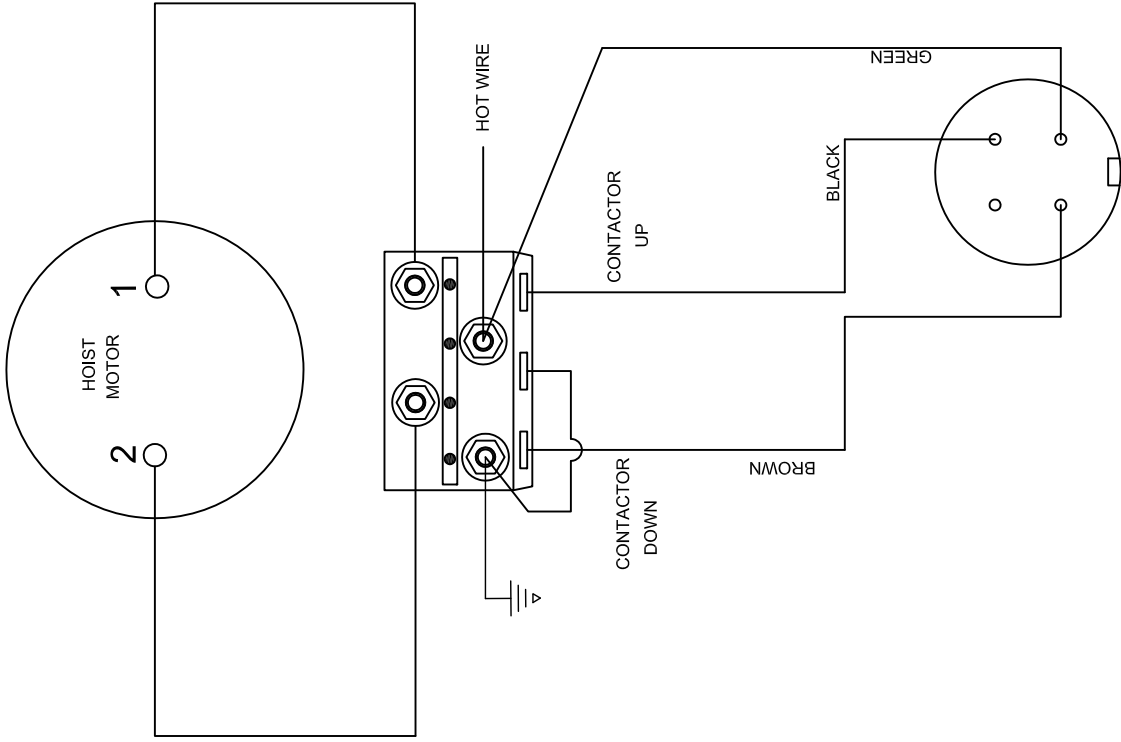

DRAWING NO.

50762-0

SCHEM, ELEC WIRING L-21
WARN WINCH DC1000 W/ CONTACTOR

DRWN BY: JC

DATE: 10/23/09

Houston TX
(713)-688-5533
www.liftmoore.com



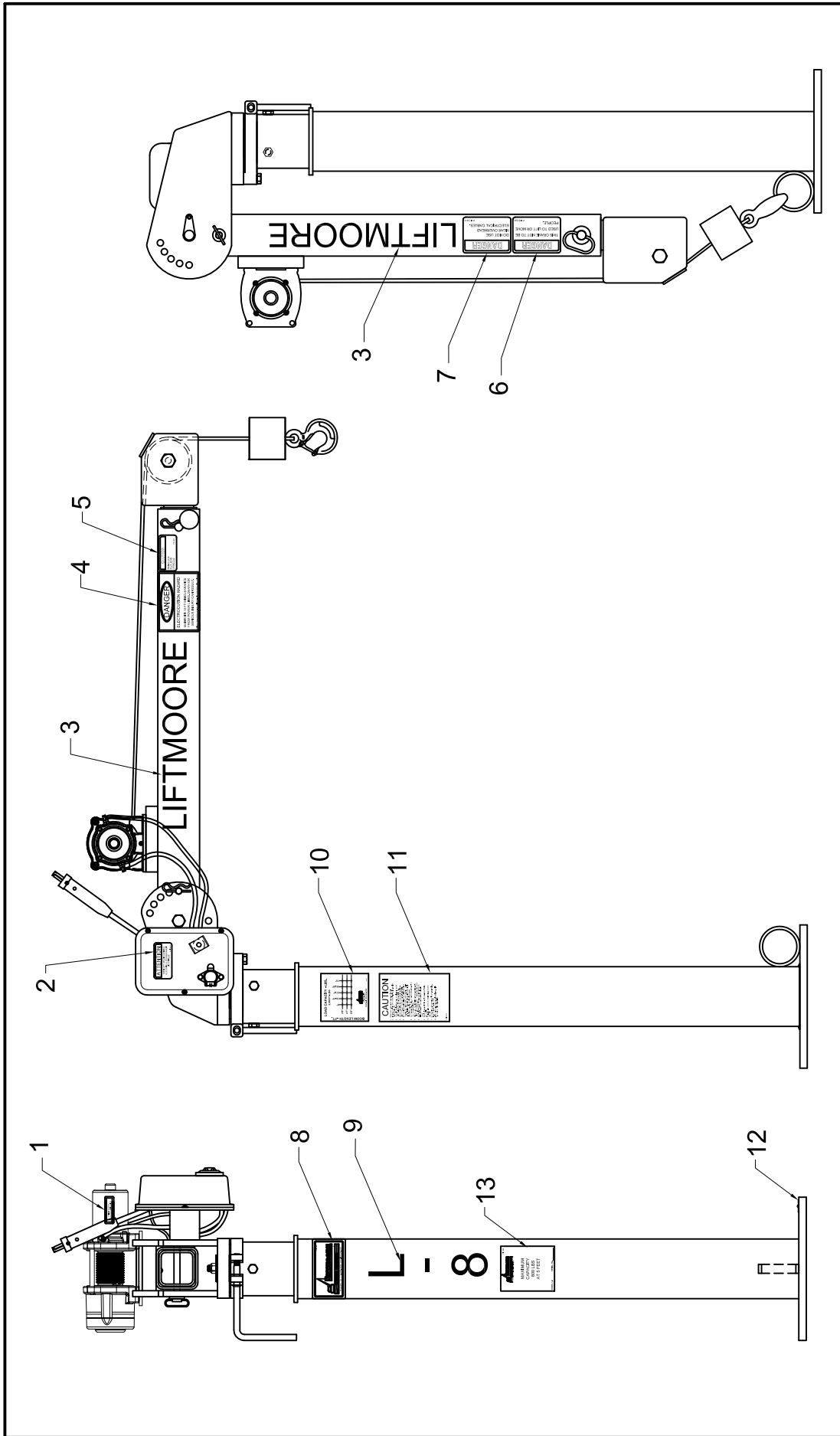

#	PN	DESCRIPTION	QTY	#	PN	DESCRIPTION	QTY	#	PN	DESCRIPTION	QTY
1	32608	DECAL, MOTOR MAGNETS DAMAGE	1	5	15612	DECAL, CAUTION PIN MUST BE IN	1	9	23485	DECAL, L-8	1
2	15577	DECAL, ATTENTION BATTERY	1	6	32085	DECAL, LIFTING PERSONNEL	1	10	23487	DECAL, LOAD CAPACITY L-8	1
3	34041	DECAL, LIFTMOORE - 2.00"	2	7	15579	DECAL, DANGER CABLES	1	11	16102	DECAL, CAUTION READ MANUAL	1
4	15618	DECAL, DANGER ELECTRIC INJURY	1	8	15582	DECAL, LOGO SMALL	1	12	23389	PLATE, SERIAL NO. MACH	1
								13	23486	PLATE, SERIAL L-8	1

DRW BY: KSP
DATE: 2/5/10

Houston TX
(713)-688-5533
www.liftmoore.com

LIFTMOORE
TRUCK CRANES

DWG, DECAL DIAGRAM L-8
DRAWING NO. 58374-A

THIS DRAWING INTENTIONALLY LEFT BLANK

FOR FUTURE ADDITIONS

OR

A PART OR FEATURE IS NOT APPLICABLE TO THIS CRANE



Houston TX
(713)-688-5533
www.iftmoore.com

DRWN BY:

DATE:

DRAWING NO.

LIFTMOORE LIMITED WARRANTY

Parts and Structural

Liftmoore, Inc. warrants each LIFTMOORE crane to be free from defects in materials and workmanship for twelve (12) months from the date of delivery to the original customer. Under the terms of this warranty the crane structural components manufactured by LIFTMOORE, Inc. are warranted for thirty-six (36) months from the date of delivery to the original customer. LIFTMOORE, Inc. will repair or replace, as its sole discretion, any equipment or part that is returned f.o.b. to LIFTMOORE, Inc.'s plant at 7810 Pinemont Drive, Houston, Texas 77040, or to one of its authorized dealers, and is found by LIFTMOORE, Inc. or its authorized dealer to have been defective at the time of original delivery.

The foregoing warranty is the exclusive warranty made by LIFTMOORE, Inc. with respect to its cranes and is in lieu of all other warranties. ANY AND ALL OTHER WARRANTIES, EXPRESS OR IMPLIED, INCLUDING ANY WARRANTY OF MERCHANTABILITY OR FITNESS OF ANY CRANE FOR A PARTICULAR PURPOSE OR OPERATION, ARE HERBY EXPRESSLY DISCLAIMED.

The foregoing warranty applies only to LIFTMOORE cranes under normal use and service and does not apply in the event of damage caused by repair or alteration or damage during shipment, accident, negligence, overloading, or misuse, including operator's failure to follow any of the instructions issued with the crane.

This warranty is limited to the original purchaser and is not assignable. In order to submit a claim, the original purchaser must provide a copy of the original invoice for the crane in question within twelve (12) months following the delivery date and within 30 days from the date of repair.

The warranty applies only when the LIFTMOORE crane is used for commercial purposes and does not cover any purchase for use for personal, family or household purposes.

LIMITATION OF LIABILITY: LIFTMOORE, Inc.'s liability for any losses or damages resulting from any cause whatsoever, including LIFTMOORE, Inc.'s NEGLIGENCE or from a defective crane irrespective of whether such defects are discoverable or latent, shall in no event exceed the purchase price of the crane to which losses or damages are claimed, or at the election of LIFTMOORE, Inc., the repair or replacement of the defective crane.

In no event shall LIFTMOORE, Inc. be liable for any special, incidental, or consequential damages, including commercial losses or costs of any kind sustained by purchaser or any other person or for any damages for which purchaser may be liable to other persons by reason of any defect in any LIFTMOORE crane or any part thereof.

LIFTMOORE, Inc. reserves the right to make changes in design or construction of its cranes at any time without obligating itself to make such changes on cranes previously manufactured.

No agent, employee, or representative of LIFTMOORE, Inc. has authority to amend or modify the foregoing warranty or to bind LIFTMOORE, Inc. by any other warranty, guaranty, or assumption of liability.

In the event any provision of this warranty is for any reason held ineffective, the remaining provisions shall remain in full force and effect.

Some states do not allow limitations on how long an implied warranty lasts or the exclusion or limitation of incidental or consequential damages, so the above limitations and exclusions may not apply to you. This warranty gives you specific legal rights, and you may also have other legal rights that vary from state to state.

