

TABLE OF CONTENTS
 USERS MANUAL P/N 28085
 4000X-16 WI DTCH MONARCH.
 16 FT BOOMS
 DTCH VALVES W / HORN

**SECTION I
 GENERAL OPERATION, INSPECTION, AND MAINTENANCE**

CRANE SAFETY RULES.....	F1122-B.....	1-1
INTRODUCTION	F1111-D.....	1-3
OPERATING RESTRICTIONS	F1112-E.....	1-4
OPERATING PRACTICES.....	F1112-E.....	1-4
INSPECTION AND MAINTENANCE.....	F1113-D.....	1-7
MONTHLY INSPECTION REPORT.....	F1123-B.....	1-9
STANDARD HAND SIGNALS FOR CRANE OPERATIONS ..	F2409-0.....	1-10

**SECTION II
 CRANE SYSTEMS AND TROUBLESHOOTING**

SAFETY SYSTEM.....	F1115-F.....	2-1
ELECTRIC HOIST.....	F1239-0.....	2-2
HYDRAULIC SYSTEM FOR ELECTRIC CRANE	F1145-D.....	2-3
TROUBLESHOOTING SAFETY SYSTEM	F1254-A.....	2-5
TROUBLESHOOTING ELECTRIC HOIST	F1243-A.....	2-6
TROUBLESHOOTING HYRAULIC PUMP	F1255-B.....	2-8
RADIO/CAN REMOTE CONTROL SYSTEM	F2385-B.....	2-9
RADIO/CAN REMOTE CONTROL SYSTEM.....	F2252-B.....	2-10
DEUTSCH CONNECTIONS & PINS	F2435-0.....	2-36

**SECTION III
 CRANE SPECIFICATIONS**

LIFTING CAPACITIES	F1509-B.....	3-1
POWER FUNCTIONS AND SPEEDS.....	F1509-B.....	3-1
BOLT AND LUBRICATION SPECS.....	F1509-B.....	3-2
CRANE LUBRICATION POINTS.....	F1509-B.....	3-3

**SECTION IV
 PARTS**

BOX PARTS LIST.....	F2422-A.....	4-1
CRANE ASSEMBLY	DWG.28083-C.....	4-2
CONTROL, FM ASSY X DRA KTG.....	DWG.26946-B.....	4-3
TRAVEL BLOCK ASSEMBLY	DWG.22532-D.....	4-4
ANTI-TWO BLOCK ASSEMBLY.....	DWG.22908-B.....	4-5
BOOM-BODY ASSEMBLY	DWG.28082-A.....	4-6
ELEVATION CYLINDER ASSEMBLY	DWG.20579-D.....	4-7
BODY ASSEMBLY.....	DWG.28081-A.....	4-8
MANIFOLD ASSEMBLY	DWG.16977-E.....	4-9
HYDRAULIC PUMP	DWG.50624-E.....	4-10
BASE-HOUSING ASSEMBLY.....	DWG.28054-A.....	4-11
ROTATION COMPONENTS.....	DWG.50540-C.....	4-12
ELECTRIC SWIVEL	DWG.50547-D.....	4-13



TABLE OF CONTENTS
USERS MANUAL P/N 28085
4000X-16 WI DTCH MONARCH.
16 FT BOOMS
DTCH VALVES W / HORN

BOOM ASSEMBLY – 16 FT.....	DWG.23900-C	4-14
BOOM INNER ASSEMBLY – 16 FT	DWG.23898-A	4-15
WINCH DRAWING	DWG.23872-C	4-16
WINCH PARTS LIST	DWG.23872-C	4-17
ELECTRICAL WIRING HARNESS.....	DWG.28039-0.....	4-18
ELECTRICAL SCHEMATIC.....	DWG.50885-A	4-19
DECAL DIAGRAM	DWG.58314-D	4-20
WARRANTY	F1442-A	



F2421-C
4/16/19

HOUSTON, TEXAS
FAX: (800) 824-5559 (USA & Canada)
FAX: (713) 688-6324
PHONE: (713) 688-5533
www.liftmoore.com

CRANE SAFETY RULES

CAUTION!

1. READ AND UNDERSTAND OPERATOR'S MANUAL.
2. INSPECT VEHICLE AND CRANE, INCLUDING ITS OPERATION BEFORE DAILY USE.
3. USE THIS EQUIPMENT ONLY ON SOLID LEVEL GROUND WITH OUTRIGGERS OR JACKSTANDS PROPERLY SET.
4. BEFORE OPERATING THE CRANE REFER TO MAXIMUM LOAD CHART ON CRANE FOR OPERATING LOAD LIMITS.
5. BE SURE LOAD BEING LIFTED IS WITHIN SAFE WINCH CAPACITY AS WELL AS SAFE CRANE CAPACITY. MULTI-PART LINE OPERATION IS REQUIRED WHEN SINGLE LINE LOAD CAPACITY OF WINCH IS EXCEEDED.
6. DO NOT OPERATE, WALK, OR STAND UNDER THE BOOM OR ANY SUSPENDED LOAD.
7. ALWAYS PAY OUT LOAD LINE BEFORE EXTENDING BOOM. WIRE ROPE DAMAGE AND / OR BREAKAGE MAY OCCUR.
8. BOOM MUST BE IN ITS REST BEFORE MOVING VEHICLE.
9. BOOM TIP MUST BE DIRECTLY OVER THE LOAD BEFORE ANY LIFTING IS STARTED. DO NOT DRAG LOADS WITH THIS CRANE.
10. MAINTAIN THIS CRANE AS REQUIRED IN THE OWNER'S MANUAL.
11. DO NOT ALLOW PERSONNEL TO RIDE ON THE LOAD LINE, LOAD, OR BOOM OF THIS CRANE.
12. IT IS UNLAWFUL TO OPERATE THIS EQUIPMENT WITHIN TEN FEET OF HIGH VOLTAGE LINE



THIS PAGE INTENTIONALLY LEFT BLANK



F1122-B
05/12/08

HOUSTON, TEXAS
FAX: (800) 824-5559 (USA & Canada)
FAX: (713) 688-6324
PHONE: (713) 688-5533
www.liftmoore.com

INTRODUCTION

This crane is a powerful machine designed to lift and move heavy loads. There are many hazards associated with these operations. Liftmoore has designed this crane to be as safe as possible but -

IT IS THE OPERATOR'S RESPONSIBILITY TO PREVENT ACCIDENTS!

This takes pre-planning, attention, and knowledge of basic principles and rules. Even if you have used similar cranes, reading this manual in its entirety will help prevent damage, injury, or even loss of life; benefits well worth the short amount of time it takes to read these pages.

REGULATORY AUTHORITY

Use of this crane is governed by OSHA 29 CFR 1910.180 and may be governed by other federal, state, or local regulations.

IT IS THE OPERATOR'S RESPONSIBILITY TO UNDERSTAND AND COMPLY WITH ALL APPLICABLE REGULATIONS GOVERNING THE OPERATION, INSPECTION, AND MAINTENANCE OF THIS CRANE.

Personnel should be trained, tested, and certified, as recommended by OSHA and ANSI standards, before operating this crane.

USING THIS MANUAL

This manual assumes that the crane is mounted on a typical service body type or similar truck, which is powered by the vehicle electrical or hydraulic system, and is controlled by either the standard pendant control or FM radio control sold by Liftmoore, Inc.

This manual is supplied to provide basic guidelines for the safe use, routine maintenance, and general inspections of this crane.

This manual is supplied to provide basic guidelines for the safe use, routine maintenance, and general inspections of this crane.

Laws, regulations, standards, or policies may be more restrictive than this manual. If a conflict exists for any limit or condition, the safest or most prohibitive shall be used. Under no circumstances shall the load, moment, or stability ratings be exceeded.

Pay particular attention to the following:

WARNING! – Draws attention to hazards, conditions, or procedures that if not observed could result in injury or death.

CAUTION! – Draws attention to hazards, conditions, or procedures that if not observed could result in damage to the crane, load, or other equipment. Equipment failure could in turn lead to injury or death.

NOTE! – Draws attention to conditions or procedures that are essential to emphasize.

For questions, interpretations, or to report errors, please contact Liftmoore, Inc, Engineering Dept.



OPERATING PRACTICES

OPERATING RESTRICTIONS

DUTY CYCLE

For Electric Cranes the duty cycle time should be limited to 10%. This is limited by heat buildup in the motors and declining charge in the batteries. (Installing extra batteries near the crane helps keep the voltage at maximum.)

PERSONNEL

LIFTING OR MOVING OF PERSONNEL IS STRICTLY PROHIBITED! This crane was neither designed nor intended to lift personnel. Under no circumstances should anyone be allowed to ride on the crane, line, or load. All non-essential personnel must be kept away when using the crane. The load must never be moved over people, nor must anyone be allowed to pass or stand under a suspended load.

ELECTRICAL LINES

Consult ANSI B30.5 for operating procedures, minimum safe distances, and prohibited zones when working around electrical lines or poles.

When operating near electrical power lines, the crane must be positioned so that the distance from the crane to the lines or poles is equal to or greater than the length of the fully extended boom plus the minimum safe distance required.

All parts of the crane, line, and load must be kept a minimum safe distance from electrical power lines and poles. This distance is 10 feet for electrical lines carrying 50kV or less.

UNDER NO CIRCUMSTANCES SHOULD A CRANE BE OPERATED UNDER ELECTRICAL POWER LINES.

SETUP

POSITION The vehicle must be positioned so that the load is kept as close to the crane base as possible to reduce the moment on the crane. Consideration must be given to starting and ending position as well as firmness and slope of the ground and any obstructions.

OUTRIGGERS The outriggers or jackstands must be firmly set and the vehicle as level as possible. This will reduce the stresses on the rotation drive and keep the load off the vehicle's suspension. Keep in mind that the weight on the vehicle will shift as the crane and load is rotated.

MANUAL BOOM EXTENSION If the manual extension part of the boom is needed, it must be extended and the boom pin placed in the required position. Insert the pin and replace the pin's hairpin keeper before attempting to lift any load.

LOAD LIMIT The operator must understand the crane load chart. The operator must ensure that the load is within the load limits over the entire range which it will be moved. Be sure to include the weight of any lifting devices including the travel block.

The load limit chart is attached to the side of the crane to aid the operator.

The boom angle indicator and chart aids the operator in determining the load capacity at various boom angles and extensions. It also gives the load limit at that configuration.

STABILITY A stability chart must be posted near the crane. The operator must understand the stability chart. The crane may be de-rated over some areas of its operating radius.



TRAVEL BLOCK The operator must determine if the load is within the single line compatibility of the winch or if a multi-part line configuration is needed.

REEVING Ensure the proper routing of the rope through the sheaves and travel block. The rope must lie in the sheave groove and must not rub against any metal objects.

Ensure the rope is correctly wound on the winch drum. The crane assembly drawing will indicate if the rope must be wound over the top or bottom of the drum. The rope must never contact any part of the winch mounting.

WARNING!

If the winch winding direction is reversed the brake will not work and the load will fall.

ATTACHING THE LOAD

POSITION The boom tip must be moved over the load before lifting so that it will be lifted straight up.

CAUTION!

Never drag a load with the crane. Dragging a load puts very high stresses on the crane for which it was not designed.

ROPE Check the rope condition to ensure it is not frayed or damaged. Ensure that the rope is not kinked and that it does not contact any sharp edges or make any sharp bends.

If using double line configuration, ensure that the lines are not twisted.

CAUTION!

Never wrap the hoist rope around the load! Serious damage to the rope WILL occur.

HOOK Always make sure the load is applied to the throat of the hook. Never use a bent hook.

CAUTION!

Always lift with the throat of the hook. Never lift with the load applied to the tip of the hook. Doing so will bend the hook.

SLINGS If the load does not have a lifting eye, use a nylon, chain, or other type of sling designed for lifting and rated for loads greater than that being lifted.

BALANCE Ensure the load will be secure and balanced when lifted. Ensure that the load cannot shift in the sling and that the sling cannot slide across the hook should the load become unbalanced.

LIFTING THE LOAD

Before lifting, ensure that the load is free from all mountings and is no way attached or stuck to anything.

Ensure that at least five full wraps remain on the winch drum at all times.

Test the winch brake by lifting the load a few inches and ensuring that it does not slip.



HOLDING THE LOAD

The operator must keep the load in sight at all times once it is lifted.

The operator must never leave the controls once the load is lifted.

The operator must ensure that no one is allowed to pass or stand under a suspended load.

CAUTION!

Never move the vehicle with a suspended load. Doing so will put dynamic loads on the crane for which it was not designed.

MOVING THE LOAD

Before moving the load, make sure the path is free of any obstructions or people.

Avoid sudden accelerations or stops. Speeds must be kept to a minimum, especially rotation, to keep the load from swinging.

Avoid sudden reversing of direction. Do not reverse direction while the load is still moving.

Make sure that no part of the crane, boom, or load makes contact with any obstruction or comes within a minimum of ten feet from any electrical line.

TRANSIT

While in transit, the crane must be stowed, preferably in a boom rest. The crane must be prevented from rotating and the hook prevented from swinging.



INSPECTION AND MAINTENANCE

OSHA and ANSI require frequent and periodic inspections. Records of these inspections must be kept readily available. Liftmoore requires periodic maintenance to ensure proper operation and prolonged life of the crane.

INSPECTION

DAILY INSPECTION

OSHA 29CFR 1910.180 (d)(2)(i) requires the following be checked daily prior to use:

- All control mechanisms for maladjustment interfering with proper operation as well as for excessive wear of components and contamination by lubricants or other foreign matter.
- All safety devices for malfunction. This should include the anti-two block and pressure switch.
- Deterioration or leakage in air or hydraulic systems.
- Crane hooks with deformations or cracks. For hooks with cracks or having more than 15 percent in excess of normal throat opening or more than 10 deg. twist from the plane of the unbent hook.
- Electrical apparatus for malfunctioning, signs of excessive deterioration, dirt, and moisture accumulation. This should include the battery terminals, master disconnect switch, electrical swivel
- The wire rope shall be replaced if any of the following conditions are noted:
 - Kinking, crushing, bird-caging, or other damage
 - Reductions from nominal diameter of more than one-sixty-fourth inch for diameters up to and including five-sixteenths inch, one-thirty-second inch for diameters three-eighths inch to and including one-half inch.
 - Thimble is not in place or is damaged
 - Any evidence of heat damage
 - Six or more randomly distributed broken wires in 1 lay
 - Three or more broken wires in 1 strand in 1 lay

MONTHLY INSPECTION

A thorough inspection of all ropes in use shall be made at least once a month and a certification record which includes the date of inspection, the signature of the person who performed the inspection and an identifier for the ropes shall be prepared and kept on file where readily available. All inspections shall be performed by an appointed or authorized person. Any deterioration, resulting in appreciable loss of original strength shall be carefully observed and determination made as to whether further use of the rope would constitute a safety hazard. Some of the conditions that could result in an appreciable loss of strength are the following:

- Reduction of rope diameter below nominal diameter due to loss of core support, internal or external corrosion, or wear of outside wires.
- A number of broken outside wires and the degree of distribution of concentration of such broken wires.



- Worn outside wires.
- Corroded or broken wires at end connections.
- Corroded, cracked, bent, worn, or improperly applied end connections.
- Severe kinking, crushing, cutting, or unstranding.

PERIODIC INSPECTION

An Annual Inspection Form is included in this manual. OSHA 29CFR 1910.180 (d)(2)ii) requires periodic inspections of this crane. Liftmoore recommends an annual inspection using the included form.

MAINTENANCE PRECAUTIONS

The crane should be maintained monthly for safety reasons and to reduce stress on the crane.

WARNING!

Never perform any maintenance while the crane has any type of load on it. Use the manual operation procedure to lower the load if necessary.

WARNING!

Hydraulic cylinders may have high pressure stored in them even after hydraulic power is removed.

The counterbalance and pilot operated check valve in the cylinder will always hold some pressure in the cylinder. Slightly extending the cylinder then retracting a small amount will relieve most of the pressure in the cylinder. **DO NOT DEADHEAD THE CYLINDER!** This will store the maximum amount of pressure in the cylinder. Care should be taken when either valve is removed from the cylinder as some pressure will still remain.

After any maintenance has been performed the crane shall not be operated until all guards have been reinstalled, all safety

devices reactivated, and maintenance equipment removed.

LUBRICATION Refer to the crane specification section for the periodic maintenance schedule and type of lubrication required.

BOLTS Bolts may loosen over time due to vibration; therefore they should be checked periodically. If bolts need to be replaced, make sure they are replaced with bolts of equal or greater strength. Check the periodic maintenance schedule (Crane Specification Section) for bolt specification and torque.

NOTE!

Sheave and boom and cylinder pivot bolts are not standard bolts. The shank and thread length of these bolts have been modified so that they do not pivot on the threads. Consult the parts section of this manual for part numbers of these bolts.

OTHER MAINTENANCE

Refer to parts drawings for any specific maintenance or adjustment procedures such as hydraulic winch brake, rotation drive gear set adjustment, Ect.



MONTHLY INSPECTION REPORT

Crane Model No. _____ **Serial Number** _____

Are Boom Hitch Pins and Keepers in place?	Yes _____	No _____
Wire Line Hook with Safety Latch Working?	Yes _____	No _____
Is Hook OK, (Not bent)?	Yes _____	No _____
Is Thimble on Wire Rope OK?	Yes _____	No _____
Is Traveling Block in use?	Yes _____	No _____
Is Wire Rope OK, not kinked or frayed?	Yes _____	No _____
Are all Boom Sections straight?	Yes _____	No _____
Are Sheave Bolts in place and tight?	Yes _____	No _____
Do all Sheaves rotate easily?	Yes _____	No _____
Are Mounting Bolts tight?	Yes _____	No _____
Is Anti Two-Block functioning properly?	Yes _____	No _____
Is Boom Angle Indicator in place and functioning and is Chart legible?	Yes _____	No _____
Are Cylinder Mounting Bolts secure?	Yes _____	No _____
Are Winch Mounting Bolts tight?	Yes _____	No _____
When stopped does winch drift less than 1.0 Inches?	Yes _____	No _____
Is Load Chart in place and easily read?	Yes _____	No _____
Are functions on Pendant operating correctly?	Yes _____	No _____
Is Hydraulic Reservoir full?	Yes _____	No _____
Is Outrigger straight and functioning?	Yes _____	No _____

Any items checked 'No' must be repaired before using this crane.





THIS PAGE INTENTIONALLY LEFT BLANK





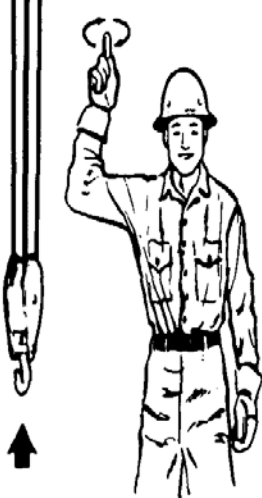
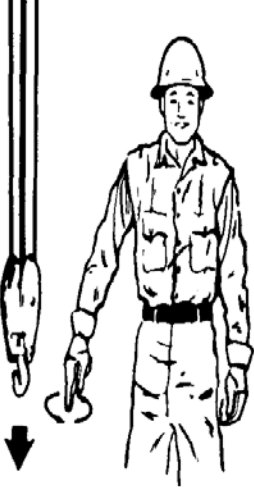

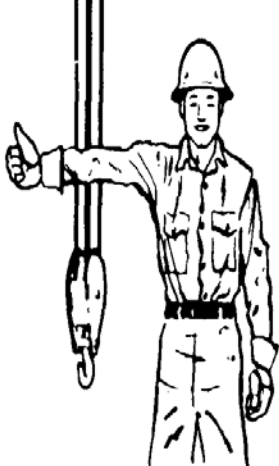
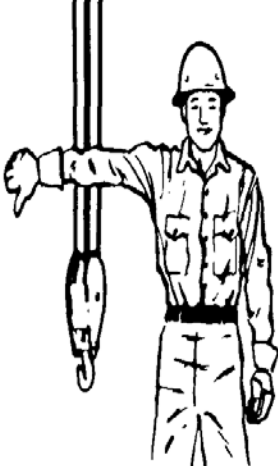

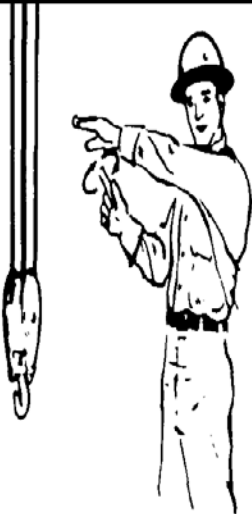
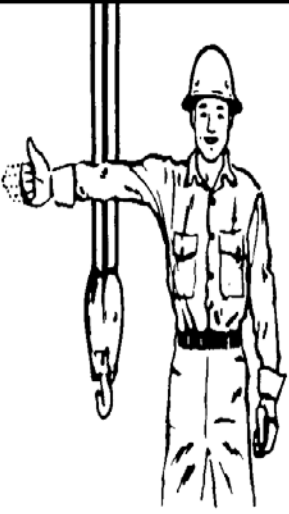
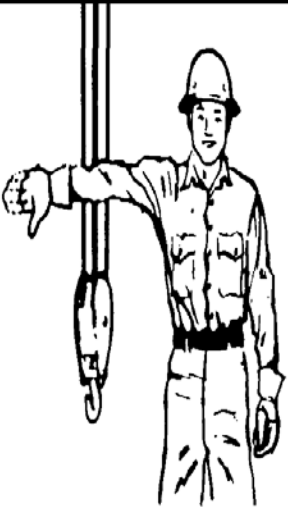
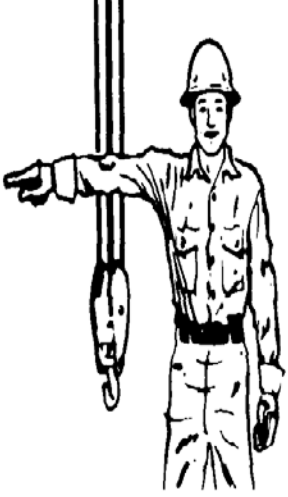
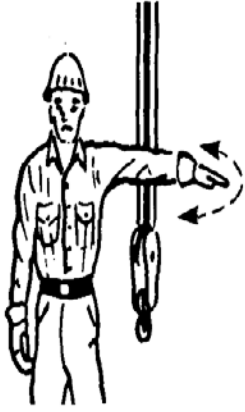
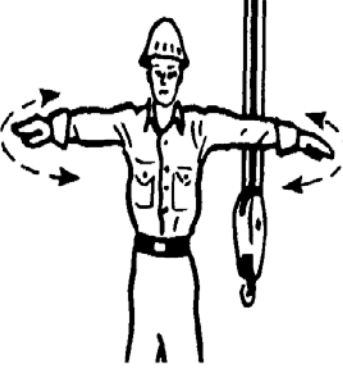

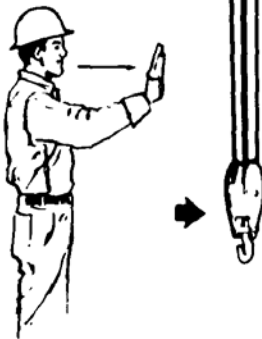
HOUSTON, TEXAS
FAX: (800) 824-5559 (USA & Canada)
FAX: (713) 688-6324
PHONE: (713) 688-5533
www.liftmoore.com

STANDARD HAND SIGNALS FOR CONTROLLING CRANE OPERATIONS

 <p>HOIST. With forearm vertical, forefinger pointing up, move hand in small horizontal circle.</p>	 <p>LOWER. With arm extended downward, forefinger pointing down, move hand in small horizontal circle.</p>	 <p>USE MAIN HOIST. Tap fist on head; then use regular signals.</p>
 <p>USE WHIPLINE (Auxiliary Hoist). Tap elbow with one hand; then use regular signals.</p>	 <p>RAISE BOOM. Arm extended, fingers closed, thumb pointing upward.</p>	 <p>LOWER BOOM. Arm extended, fingers closed, thumb pointing downward.</p>

 <p data-bbox="256 751 597 934">MOVE SLOWLY. Use one hand to give any motion signal and place other hand motionless in front of hand giving the motion signal. (Hoist slowly shown as example.)</p>	 <p data-bbox="630 751 971 898">RAISE THE BOOM AND LOWER THE LOAD. With arm extended, thumb pointing up, flex fingers in and out as long as load movement is desired.</p>	 <p data-bbox="1003 751 1344 934">LOWER THE BOOM AND RAISE THE LOAD. With arm extended, thumb pointing down, flex fingers in and out as long as load movement is desired.</p>
 <p data-bbox="264 1497 597 1570">SWING. Arm extended, point with finger in direction of swing of boom.</p>	 <p data-bbox="638 1497 971 1602">STOP. Arm extended, palm down, move arm back and forth horizontally.</p>	 <p data-bbox="995 1497 1328 1602">EMERGENCY STOP. Both arms extended, palms down, move arms back and forth horizontally.</p>

 <p>TRAVEL. Arm extended forward, hand open and slightly raised, make pushing motion in direction of travel.</p>	 <p>DOG EVERYTHING. Clasp hands in front of body.</p>	 <p>TRAVEL (Both Tracks). Use both fists in front of body, making a circular motion about each other, indicating direction of travel, forward or backward. (For land cranes only.)</p>
 <p>TRAVEL (One Track) Lock the track on side indicated by raised fist. Travel opposite track in direction indicated by circular motion of other fist, rotated vertically in front of body. (For land cranes only.)</p>	 <p>EXTEND BOOM (Telescoping Booms). Both fists in front of body with thumbs pointing outward.</p>	 <p>RETRACT BOOM (Telescoping Booms). Both fists in front of body with thumbs pointing toward each other.</p>
 <p>EXTEND BOOM (Telescoping Boom). One Hand Signal. One fist in front of chest with thumb tapping chest.</p>		 <p>RETRACT BOOM (Telescoping Boom). One Hand Signal. One fist in front of chest, thumb pointing outward and heel of fist tapping chest.</p>

THIS PAGE INTENTIONALLY LEFT BLANK



HOUSTON, TEXAS
FAX: (800) 824-5559 (USA & Canada)
FAX: (713) 688-6324
PHONE: (713) 688-5533
www.liftmoore.com

SAFETY SYSTEM

The safety system is designed to help prevent damage to the crane that would be caused by overload or two-blocking. The system consists of a load sensor, anti-two block device (optional on smaller, electric cranes), and limiting system control board.

When the applicable switch detects an overload or two-block condition, the limiting system will prevent activation of winch up, boom down, and extend out since these directions would cause damage. Winch down, boom up, extend in, and power rotation will still function so that the crane can be moved to a safe configuration.

CAUTION!

Never de-activate or override safety functions. Doing so can result in serious damage to the crane and possibly injury or death.

LOAD SENSOR

A pressure activated switch in the elevation cylinder acts as a load sensor. This switch is normally closed and opens at the preset pressure corresponding to the load rating of the crane.

CAUTION!

The load sensor will not function when the elevation cylinder is fully retracted and is inaccurate when the boom is below horizontal.

CAUTION!

The operator must never rely strictly on the load sensor to determine overload conditions. The load and load limits must always be known and adhered to.

ANTI-TWO BLOCK

The anti-two block device (optional on smaller electric cranes), mounted on the boom crown plate, consists of a normally open switch actuated by a lever. A weight is attached to the lever and holds the switch

closed. If the weight is lifted by the hook or travel block the switch opens.

The power and signal wires are wired through the cord reel, which is in turn wired to the ATB switch.

LIMITING SYSTEM CONTROL

The limiting system control prevents output of winch up, boom down and extend out if it is not receiving a signal from either the ATB or load sensor.

The ATB does not trip boom down when winch is mounted on the boom.

There is a one second delay before deactivation of boom down when the load sensor is tripped to prevent false readings caused by pressure spikes.

MISCELLANEOUS

UP LIMIT SWITCH

The up limit switch prevents the elevation cylinder from reaching full extension. If the elevation cylinder were to "dead-head", the resulting pressure would activate the load sensor, preventing boom down. The boom would then have to be lowered using the manual operation buttons on the solenoid valves.

CIRCUIT BREAKER, FUSE

For electric cranes a 150 Amp circuit breaker is supplied with the crane. It should be installed as close to the battery as possible. For hydraulic cranes a 10 Amp blade type fuse is supplied.

DISCONNECT SWITCH

A power disconnect switch is supplied with the crane. Power to the crane should be turned off whenever not in use. This is to prevent inadvertent or unauthorized use and will help prevent corrosion at electrical connections.



ELECTRIC HOIST

Permanent Magnet Motor

This Liftmoore crane features an electrically driven planetary gear hoist. The hoist is powered in both directions and features an automatic internal brake to positively control the load.

The hoist is permanently lubricated at the factory. Barring damage or part replacement, no further lubrication is necessary.

MOTOR

The hoist motor is a permanent magnet, reversible, direct current (DC) motor.

CAUTION!

The hoist motor is rated for intermittent duty. Duty cycle is limited to 5 minutes in 30 to allow the motor to cool. Extended use can damage the motor.

CAUTION!

When the motor approaches stall, a very rapid heat build up occurs which can cause permanent motor damage. Discontinue use when the motor speed is reduced excessively by voltage drop or load.

BRAKE

The hoist features a single acting, overrunning brake. It automatically activates to hold the load and assist in lowering the load.

WARNING!

The hoist brake only functions in one direction. If the hoisting direction is reversed by reversing the rope winding direction the brake will not hold and the load will fall. Serious injury or death could occur.

The brake is factory set and is not adjustable. If the brake fails to hold the load or if downward drift becomes excessive the brake must be replaced.

DIRECTIONAL CONTROL

Motor direction is controlled by either a solenoid pack or sealed contactor. Schematically, they are identical - two double pole-double throw solenoids are used to reverse polarity to the motor terminals.

Signal voltage, controlled by the pendant, energizes the selected directional solenoid, directing power to the winch terminal through the normally open terminal. The other terminal remains grounded through the normally closed terminal of the other solenoid.

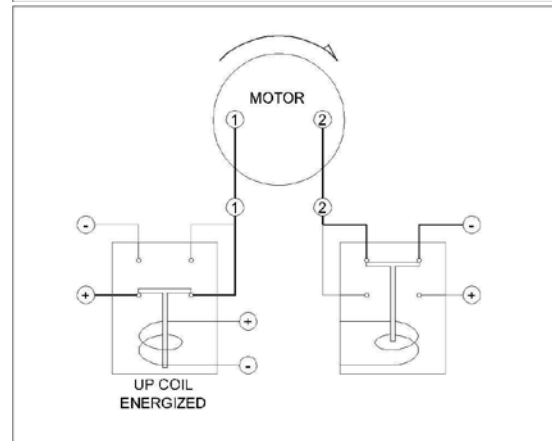
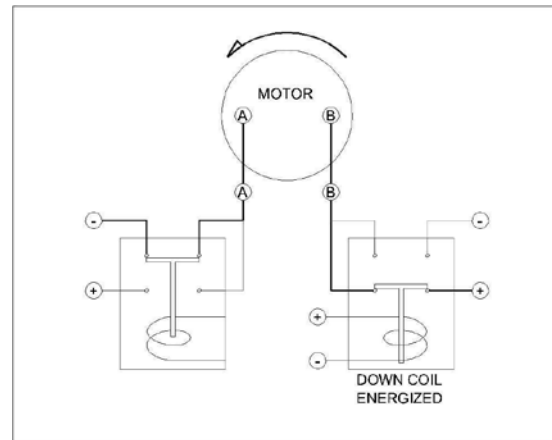

HYDRAULIC SYSTEM FOR ELECTRIC CRANES

The hydraulic system consists of the hydraulic pump, manifold, solenoid valves, cylinders, motors, and tubing and hoses. Hydraulic power is generated by the electrically driven hydraulic pump on the outside of the housing. The hydraulic system is plumbed in series so that more than one function can be operated simultaneously.

PUMP

The hydraulic pump assembly consists of a DC permanent magnet electric motor, pump, and reservoir.

The motor is activated by the pump solenoid. The solenoid is energized by the pendant control whenever a hydraulic function is activated.

The pump provides fluid pressure to power hydraulic functions. The system incorporates an adjustable relief valve to prevent damage that can be caused by over pressurizing the system.

Fluid is drawn from and returned to the reservoir. Servicing the hydraulic pump consist of maintaining the oil level. The reservoir should be kept as full as possible to prevent condensation from forming inside the tank. Also ensure the oil is not contaminated by water, dirt, rust, etc. See crane specification sheet for hydraulic oil type.

SOLENOID VALVES

Each hydraulically operated function is controlled by a 4-way, 3-position (open and close) center solenoid valve. It is electrically operated and spring biased to center. A manual operation button is incorporated in the coil-retaining nut. Valves are mounted to the series manifold.

CYLINDERS

Most hydraulic cylinders are double acting cylinders with integrally mounted counterbalance valve and pilot operated check valves. Refer to the cylinder drawings for specific information.

All cylinders use a counter-balance load holding cartridge valve on the extend port.

This valve performs 3 functions:

- Controls the rate of decent when lowering the load
- Keeps load from falling in the event of sudden loss of system pressure, such as when a hose bursts.
- Acts as a relief valve to prevent damage from induced load or thermal expansion.

It allows free flow to extend then blocks flow until opened by pilot pressure to the retract port or when the relief pressure is reached.

Some cylinders utilize a pilot operated check valve on the retract port to prevent the cylinder from creeping out under no load conditions. This valve allows flow into, but prevents flow from the retract port, thus hydraulically locking the cylinder until opened by pilot pressure to the extend port.

MOTORS

THE HYDRAULIC MOTOR USED BY THE ROTATION DRIVE IS A HIGH-TORQUE, LOW-SPEED CONSTANT DISPLACEMENT MOTOR. MANUAL OPERATION

If electrical problems occur the solenoid valves may be operated manually by depressing the manual operation button incorporated in the coil-retaining nut. Using a blunt object such as a bolt or screwdriver handle may be required to assist operation if high pressures are needed. Refer to the manifold drawing for function valves and directions.

If possible, activate the pump by activating a hydraulic function on the pendant. If this does not work, then energize the pump solenoid using a jumper from the hot side of



the solenoid to the coil post where the WHT/BLK wire is connected. If this fails also then battery voltage can be applied directly to the pump motor.

If hydraulic power is lost while a load is suspended, the load can be lowered by decreasing the setting on the counter-balance valve. This should only be done in extreme cases. The valve must be reset before the crane is returned to use.

WARNING!

The boom may fall if the adjustment is made too fast. Do not stand where the boom may hit you if it falls. Serious injury or death may result

WARNING!

The area between the boom and the cylinder, the boom and the housing, and the cylinder and the housing will change as the boom position changes and could form pinch points. Do not position any part of your body in these areas as it may be pinched or crushed as the boom lowers.

To decrease the setting, loosen the locknut on the valve, then slowly turn the adjustment stem **CLOCKWISE** until the load begins to lower. Count the number of turns so that the valve can be returned to its original setting.

Alternately, a pressure gage must be put on the retract port to adjust the setting so that approx. 1800 PSI is required to lower the boom with no load.

Test the setting by lifting a known load near the moment rating.

TROUBLESHOOTING SAFETY SYSTEM

DTCH Relay Card

To check functions controlled by the safety system check the status indicators. (See Relay Box Assembly drawing.) If only one of the safety functions is not working, activate that function and check for error codes and/or its output status indicator.

For non-FM systems, if the status indicator lights then the problem is in the wiring or in the solenoid coil. If the light does not illuminate, check the control pendant. If the control pendant is good then the crane control module needs to be replaced.

For FM systems, check for error codes. If none are present, see the FM Troubleshooting section.

If boom out, boom down and winch up are not working, confirm that the control board has power. Confirm that the board is receiving a signal from the ATB and load sensor.

If the error code is active, ensure that the crane is not overloaded and that the ATB lever is holding the switch closed. Check for voltage at the ATB and Load Sensor inputs.

CHECK LOAD SENSOR SWITCH

If the load sensor input is not receiving voltage, locate the load sensor connector inside the crane housing. The plug side will have a red wire and a gray wire, the receptacle side will have a red and a white wire.

Disconnect and check for continuity between the two pins on the receptacle (switch side). If there is no continuity then the load sensor is bad and needs to be replaced.

CHECK ATB SWITCH

If the ATB input is not receiving voltage remove the ATB housing cover and disconnect the connector. Check for continuity on the switch side. Lifting the weight should break the continuity. If either of these conditions is incorrect the switch is bad and needs to be replaced.

CHECK CORD REEL

Check the ATB switch if not done so already. Locate the ATB connector inside the crane housing. The plug side will have a red wire and a black wire. The receptacle side will have a white wire and a black wire.

Disconnect the plug going to the switch. Check for continuity between the two pins on the receptacle. Have someone lift the weight on the ATB and continuity should be broken. If either of these conditions are incorrect then the cord reel is bad and needs to be replaced.

CHECK POWER TO SAFETY SWITCHES

If the safety switch is good, check for voltage at pin 1 (the red wire) on the plug. If there is no voltage, follow the wire back to the 6-pin power distribution plug, checking for breaks or shorts.

Remove the power distribution receptacle (cap).

NOTE!

Removing the cap will disconnect power to all electrical components. Be sure to replace the cap before continuing.

Check the cap for bent pins. Check that all wires are fully seated in the plug. If they are not, then remove the green locking wedge and push the wires forward until seated. Reinstall the wedge ensuring that no wires are pushed back.



TROUBLESHOOTING ELECTRIC HOIST

Permanent Magnet, Contactor Controlled

IMPORTANT NOTE!

The importance of first physically checking every connection between the battery and the crane cannot be overstressed!

Poor connections or poor grounding account for a large percentage of hoist problems. Time is often wasted chasing other probable causes only to eventually find a loose or corroded connection. **Measuring the voltage is not sufficient.** Often a poor connection will allow enough amperage to operate a meter or test light, but not enough to operate the hoist, which requires very high amperage.

If the problem is random and intermittent then it is almost assuredly a loose or bad connection.

Another common problem is low battery voltage. Even if the battery is good when troubleshooting begins, running the winch can quickly drain a battery. If it can be done safely, it is best to have the vehicle running.

Also check the control socket and plug for bent, corroded, or dirty pins.

CAUTION!

As the motor approaches stall, due to low voltage or excessive load, a very rapid heat build up occurs which will quickly damage the motor. If the motor is not turning, do not operate the switch for more than a second. Allow the motor to cool between attempts to make it run.

HOIST OPERATES IN ONLY ONE DIRECTION

If the hoist only operates in one direction swap the control wires on the contactor.

Activating the pendant switch in the working direction should now operate the hoist in the previous non-working direction.

Example: if hoist up is not working, after swapping the control wires activating the hoist down switch should cause the hoist to go up.

If it does then the hoist and contactor are working correctly and the problem is in the pendant crane socket or wiring. If it does not then the problem is the contactor or brake.

If the motor tries to turn but stalls then the problem is most likely the brake. Also, if the contactor makes a clicking noise then that is a good indication that it is working and, again, the problem is most likely the brake.

If the control wires were swapped in the previous step, return them to their original positions. Swap the motor wires (labeled 1 and 2). It is usually easiest to swap them at the motor.

Activating the pendant switch in the working direction should now operate the hoist in the previous non-working direction.

Example: if hoist up is not working, after swapping the motor wires activating the hoist down switch should cause the hoist to go up.

If it does, then one side of the contactor is not working and it needs to be replaced.

If it does not work, the problem is a brake malfunction. Inspect the brake installation. Correct any problems found. The brake cannot be repaired. Replace if any damage is found.



HOIST DOES NOT RUN IN EITHER DIRECTION

If the hoist does not run in either direction then the problem is either lack of power to the control socket or pendant, lack of sufficient power to the motor, or hoist brake malfunction or motor failure.

If the contactor clicks when the switch is activated then the control socket is getting power.

If all connections have not been checked, do so now. Also ensure that the battery still has sufficient power. As a rule of thumb, if it has enough power to start the engine, then it is good.

Activate the winch toggle switch and check for voltage at motor contacts. If positive voltage is measured at both terminals, the problem may be the ground wire from the contactor. Check for tightness or corrosion on this wire.

Once sufficient power is ensured, if there is any indication that the motor is trying to turn but stalls the problem is the brake – have it replaced.

If there is no indication that the motor is trying to turn and the contactor has been tested, then replace the motor.

TESTING THE PENDANT AND CONTROL WIRING

If the problem is narrowed to the control wiring, it is most likely caused by a cut or disconnected wire. A visual inspection of the

wiring should be made and repairs made as necessary.

Refer to the schematic and pendant drawing for pin functions and locations.

If no visual defects are found and if a continuity tester is available, disconnect the pendant and check for continuity between the control socket pin and terminal at the contactor.

Alternately, a piece of wire or metal object may be used to short between the control socket power pin and the socket hoist pin(s). If the hoist operates then the problem is in the pendant.

If not, check for power at the control socket power pin. If there is no power, trace the wiring back, checking each connection until the problem is found. Correct as necessary.



TROUBLESHOOTING HYDRAULIC PUMP

Electric Pump, 14P Socket

IMPORTANT NOTE!

The importance of first physically checking every connection between the battery and the crane cannot be overstressed!

Poor connections or poor grounding account for a large percentage of electrical problems. Time is often wasted chasing other probable causes only to eventually find a loose or corroded connection. **Measuring the voltage is not sufficient.** Often a poor connection will allow enough amperage to operate a meter or test light, but not enough to operate the motor, which requires very high amperage.

If the problem is random and intermittent then it is almost assuredly a loose or bad connection.

Another common problem is low battery voltage. Even if the battery is good when troubleshooting begins, running the motor can quickly drain a battery. If it can be done safely, it is best to have the vehicle running.

Also check the control socket and plug for bent, corroded, or dirty pins.

CAUTION!

As the motor approaches stall, due to low voltage or excessive load, a very

rapid heat build up occurs which will quickly damage the motor. If the motor is not turning, do not operate the switch for more than a second. Allow the motor to cool between attempts to make it run.

FOAMY FLUID

If the fluid foams then the problem is the pump seal – have it replaced.

PUMP DOES NOT RUN

If both the pump and winch are not working, the problem is power related or control wiring related. Troubleshoot those areas first.

If the solenoid is actuating it will make a clicking noise. If the solenoid is not clicking, check for power at the coil input (small screw terminal) on solenoid when the Boom Up switch is activated. If there is no power then the problem is the electrical wiring harness or pendant control wiring.(refer. to CONTROL TROUBLESHOOTING CHART).

If the coil is getting power when the switch is activated, but not clicking then the problem is most likely the solenoid.

If the solenoid is clicking check for full power input to the solenoid. Trace the wiring back to the crane input, checking for power at each connection until the problem is found. If full electrical power to the motor is confirmed then the motor is faulty and should be replaced.



RADIO/CAN REMOTE CONTROL SYSTEM
 INSTALATION AND OPERATION MANUAL

STEP I

TRANSMITTER AND RECIVER SYNCRONIZATION (SEE P/N 26946)

1. WITH CRANE POWER ON
2. TURN THE TRANSMITTER AND RECEIVER OFF
3. PRESS AND HOLD **BOOM UP** AND **EXTEND IN** SWITCH
4. WHILE HOLDING SWITCHES, RELEASE THE **E-STOP**
4. RELEASE THE SWITCHES. LEDS SHOULD BLINK AT THIS POINT
5. APPLY POWER TO RECIEVER. GREEN LED SHOULD GO FROM STEADY TO RAPID BLINKING ON THE TRANSMITTER
6. TEACH COMPLETE

STEP II

CRANE SYSTEMS TROUBLESHOOTING USING DIAGNOSTICS TOOL

1. CONNECT HARNESS(TTCT-1009) AND **WIFI DIAGNOSTICS TOOL(P/N 26684)** TO CRANE AS SHOWN ON DIAGRAM BELOW
2. TURN ON POWER TO CRANE/RECEIVER
3. USE YOUR DEVICE (LAPTOP/TABLET)AND LOOK FOR “**LIFTMOOREREMORE**”
4. IF REQUIRED PASSWORD IS (23456789)
5. ONCE CONNECTION IS COMPLETE GO TO WEB BROWSER EXAMPLE:
 INTERNET EXPLORER/GOOGLE CHROME/FIREFOX/IOS SAFARI
6. ENTER “**192.168.1.1**” IN ADDRESS BAR TO ACCESS MAIN SCREEN

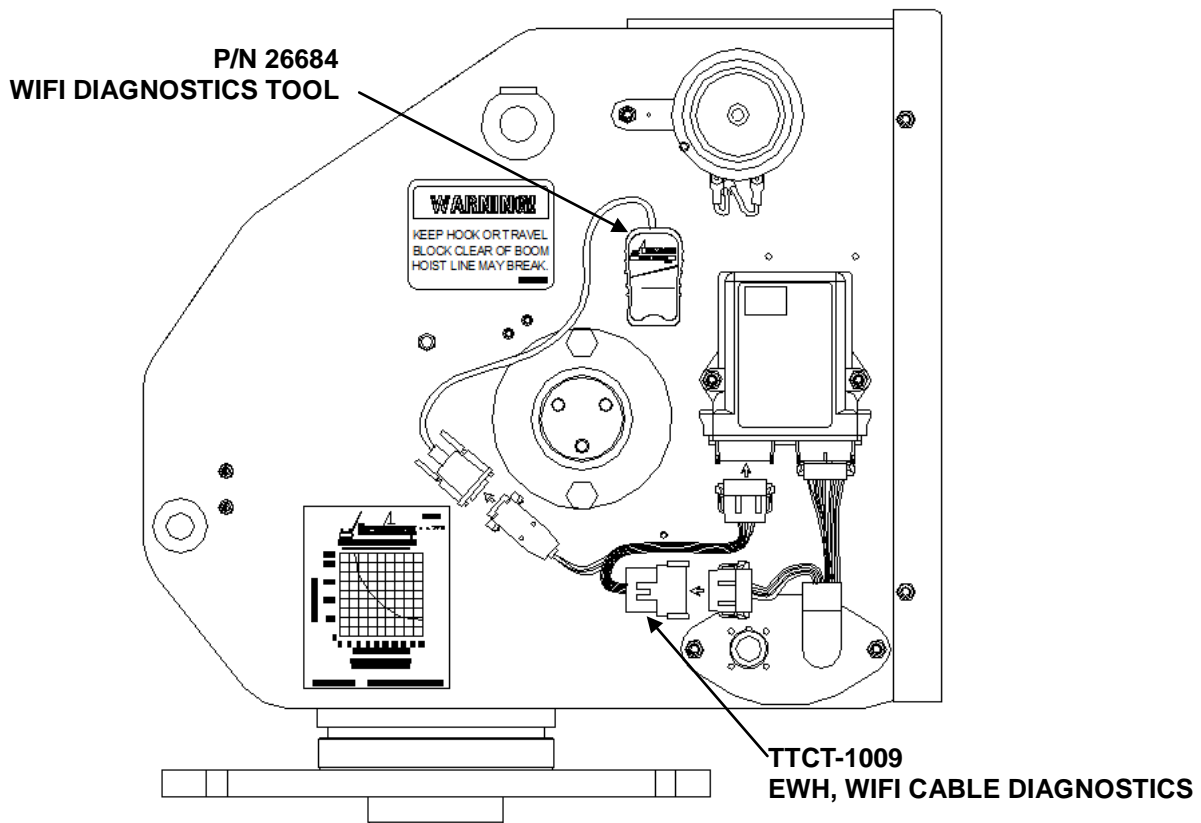

THIS PAGE INTENTIONALLY LEFT BLANK



HOUSTON, TEXAS
FAX: (800) 824-5559 (USA & Canada)
FAX: (713) 688-6324
PHONE: (713) 688-5533
www.liftmoore.com



GUIDER

RADIO/CAN REMOTE CONTROL SYSTEM

INSTALLATION AND OPERATION MANUAL

LIFTMOORE
3B1061CJ.doc
January 20, 2016
BK

GUIDER REMOTE

INDEX

DESCRIPTION	2
OPERATION	3
INDICATOR LEDs	3
TRANSMITTER AND RECEIVER SYNCHRONIZATION	4
BATTERY CHARGING	6
OUTPUTS	7
INPUTS	7
INSTALLATION	8
BEFORE APPLYING POWER!	8
SYSTEM TROUBLESHOOTING USING OPTIONAL GATE:	10
ACCESSING THE CONTROL PANEL	10
DIAGNOSTICS	11
CALIBRATION	12
HISTOGRAM	15
SOFTWARE UPDATE	16
GATE CONFIGURATION	17
WIRING CRANE RECEIVER	18
WIRING ENGINE RECEIVER	19
ROUTINE MAINTENANCE	20
MAINTENANCE PRECAUTIONS	20
TROUBLESHOOTING	21
TROUBLESHOOTING CHART	22
ERROR CODES	23
TRANSMITTER PICTORIAL	26
CRANE RECEIVER PICTORIAL	27
ENGINE RECEIVER PICTORIAL	28
SPECIFICATIONS	29
INSTRUCTION TO THE USER	30

GUIDER REMOTE

DESCRIPTION

The GUIDER REMOTE is a state of the art microprocessor based Radio Frequency (RF) control system. It will provide the operator the ability to wirelessly operate equipment. The operator is required to follow all OSHA www.osha.gov and other applicable safety standards when operating the equipment. Do not use high power radio devices in close proximity of this product.

The remote control system consists of: the radio transmitter, main receiver module, engine receiver module, and associated optional equipment such as wiring harnesses and Gate interface tools.

The transmitter is equipped with a trigger, twist to release E-stop switch and toggle switches for the various functions. It includes a port for wired control via the built-in Controller Area Network (CAN) system¹. This unit runs on a 7.2V rechargeable pack when in wireless mode. When in wired mode, the transmitter runs with power supplied by the CAN cable. This is useful if the battery power gets too low to operate the transmitter but continued operation is needed. The port is also used to charge the internal battery.

The system's radio receiver has both current-regulated proportional outputs and ON/OFF outputs to accommodate the functions available on the transmitter. All

¹ The CAN control will only work with the CRANE module. The ENGINE module only works on RF

GUIDER REMOTE

outputs are current-sourcing. It also includes a port for wired (CAN) and RS-232 communication for system diagnostics.

OPERATION

Power must be applied to the receiver module for the system to work.

Releasing the E-STOP will turn on the transmitter. Pressing the E-STOP button will turn off the transmitter. Pressing the E-STOP will turn off all outputs as a safety feature. If the transmitter goes out of range for more than 2 seconds, all outputs will turn off as a safety feature, the e-stop output will turn off after 10 seconds.

To operate a proportional output, toggle the switch of the

desired function and pull the trigger to the level desired. ***Please note that if the trigger is pulled before the function is selected, the proportional output will not work as a safety feature.** Release the trigger and begin again in the proper sequence.

To save battery life, the transmitter will turn off when it is idle (no functions are used) for period greater than 1 hour. The user must press and release the E-STOP at this point to restore transmitter operation.

INDICATOR LEDs

The transmitter has two indicators, the red BATTERY indicator and the green TRANSMIT indicator. The green TRANSMIT indicator blinks rapidly (2x/second in RADIO mode, 5x/second in CAN mode)

GUIDER REMOTE

whenever there is communication between the transmitter and the receiver.

The red BATTERY indicator starts blinking once every second when the battery voltage is low and requires charging. Plug in the transmitter as soon as possible after seeing the low battery indicator. See BATTERY CHARGING below.

The receiver module can identify problems with the system in the form of an error code. Check the display window on the receiver to diagnose system problems. If there are multiple errors present, press Engine HIGH/LOW then HORN on the transmitter. While holding the HORN button, toggle HIGH/LOW to scroll through all the errors. Then, refer to the ERROR CODE CHART in this manual for

explanation of the error codes. The green LED indicator will blink on the receiver during active operation.

The red and green LEDs are also used as a warning to the operator in case of overload and anti-two-block conditions. When both LEDs flash together then there is an overload condition present. If the red and green LEDs toggle, there is an anti-two-block (ATB) condition present. In either of these conditions, WINCH UP, EXTEND, and BOOM DOWN will be disabled. Refer to your crane manual for additional information on overload and ATB.

TRANSMITTER AND RECEIVER SYNCHRONIZATION

Each radio remote system is designed to operate with a

GUIDER REMOTE

unique radio ID code and RF channel sequence. Each receiver is programmed to respond *only* to the transmitter with the correct ID code/RF channel sequence for which it is set. This feature allows multiple systems to work in close proximity to one another without interference.

In the event that a transmitter becomes damaged and a new one is needed, the receiver can be reprogrammed to respond to the new transmitter. To teach the ID code to the receiver, use the following procedure. ***Please note that if this procedure is interrupted before it has completed, the system may have intermittent operation:**

For 3B1063B, Crane Receiver:

TEACH BY CAN CABLE

1. Plug the CAN cable into the CAN port on both the receiver and transmitter and operate a function on the transmitter until the LEDs on the front panel go from steady to flashing for at least 5 seconds. The units will be synchronized at this point

TEACH BY RF

1. Turn the transmitter and receiver off
2. Press and hold BOOM UP and EXTEND IN. Release the E-stop
3. Release the switches. LEDs should toggle at this point
4. Apply power to the receiver. Only the green LED should start to blink rapidly on the transmitter

GUIDER REMOTE

5. Teach complete

For 3B1064A, Engine Receiver:

1. Apply power to the receiver and the TEACH ID pin on the receiver
2. Twist to release the E-stop switch to turn transmitter on. Press and hold a function on the transmitter (use a crane function if teaching the CRANE receiver or an engine function if teaching the ENGINE receiver). Green LED will flash, go steady briefly, and then flash continuously
3. Release function
4. Remove power from TEACH ID pin on receiver
5. Teach complete

BATTERY CHARGING

The transmitter is designed with a smart battery charger. The battery can be charged by connecting the CAN cable from the receiver module (powered on) to the port on the transmitter, or by plugging the AC wall charger or DC cigarette charger (minimum 2A @ 12.6VDC) into the port. Red and green LED indicators on the underside of the transmitter indicate the status of the charger: A red LED indicates that the battery is charging and a green LED indicates that the battery is fully charged. A complete charge can be achieved in about 1 hour.

IMPORTANT BATTERY INFO

When the battery is new, the run-time of the transmitter will be shorter until it has gone

GUIDER REMOTE

through the drain/charge cycle several times. After this point, the unit's current drain should allow at least 20 hours of run-time before a recharge is needed.

The temperature that the transmitter battery is exposed to affects performance and useful life. It is strongly recommended you keep within the following limits:

- A. Charging: -4 to +86°F
- B. Operating: -20 to +122°F
- C. Storing: -4 to +86°F
(lower is better)

OUTPUTS

Each of the outputs from the receiver module is designed with built-in short circuit and overload protection. The outputs can also detect a no-load or broken wire condition.

These error conditions are evident by the alphanumeric display on the receiver module *or* the HISTOGRAM page on the optional Gate.

The ON/OFF outputs will indicate an error under no load or broken wire status if NOT activated, and will detect a short IF activated. The proportional outputs will detect a no-load or short condition WHEN activated.

INPUTS

Digital inputs are available for TEACH ID (3B1064A receiver only), ATB, and PRESSURE signals. They will function up to battery voltage levels. One analog input is available for a PRESSURE TRANSDUCER. This expects a signal from 0-5V.

GUIDER REMOTE

INSTALLATION

Refer to the WIRING CHART in this manual for hookup of the harness.

To install the receiver module, use the two mounting holes provided on the enclosure to attach it in a vertical manner with the connectors facing down. Please take extra caution not to damage internal components while installing. For high vibration applications, use shock absorbing mounts. It is advised to mount the unit as high as possible, keeping clear of metal obstructions around the antenna which might affect RF performance. Antenna extension cables are available from to aid in this, if needed.

The main power to the receiver should be connected through a

switched, fused line capable of a minimum of 20 amps. For best results, connect power (+) to the receiver via an auxiliary terminal of the ignition switch, PTO switch, or ignition relay. Be sure that the ground (-) is connected securely to the chassis or battery with a star washer which digs into the base metal to insure good contact.

All connections must be properly insulated to protect against shorts.

Seal all connections with a non-conductive silicone grease to prevent corrosion.

BEFORE APPLYING POWER!

- Check power and ground for proper polarity.
- Check the wiring harness for

GUIDER REMOTE

possible shorts before connecting to output devices (i.e., valves and relays) by checking each mating pin terminal.

- Verify that the transmitter battery is fully charged.
- Read the rest of this manual.

GUIDER REMOTE

SYSTEM TROUBLESHOOTING USING OPTIONAL GATE:

3B1063B and 3A3593A
receiver.

The GATE connects to the receiver/controller thru the RS232 diagnostic port.

Note: To prevent electrical shorts and damage turn Receiver power off. Plug gate to the receiver then turn power on to the receiver.

The GATE creates a Wi-Fi access point which allows you to connect to any device with Wi-Fi and web browser such as smart phones, pads or personal computers. It supports Google Chrome, Internet Explorer, Firefox and IOS Safari and allows user to configure, diagnose and troubleshoot the system. Note: the gate application software works with the



Gate Diagnostic Tool

ACCESSING THE CONTROL PANEL

1. Turn off power to the receiver.
2. Plug in the GATE to the receiver.
3. Turn on the power to the receiver. The power LED on the GATE will turn on at this point

GUIDER REMOTE

4. Use your device and look for the available WiFi networks. A network under the name of "LIFTMOOREREMOTE" should be available at this point. Connect to the network, if required password is 23456789.
5. Once the connection is established, open a web browser on your device. The Firefox browser is recommended.
6. Enter the address `http://192.168.1.1` in the address bar

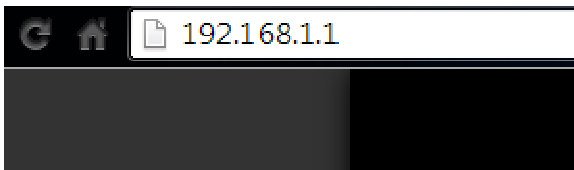

Address Bar

7. The following options are available from the main screen.

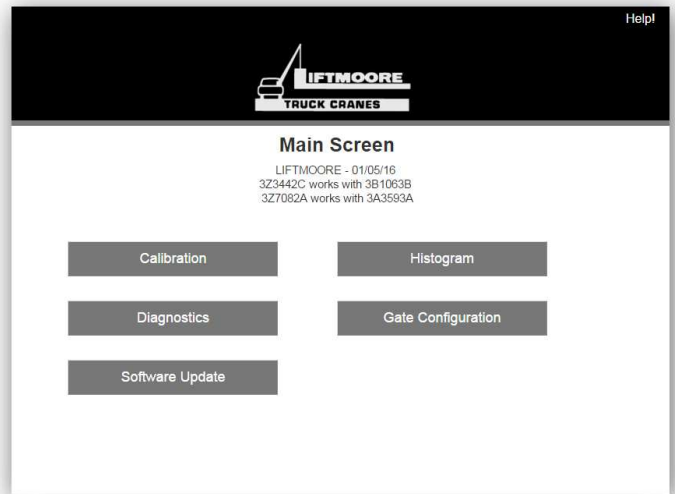

Main Screen

DIAGNOSTICS

Tap the `Diagnostics` button to see the diagnostic screens, which shows the present state of remote communications, and system I/O.

When the round circle next to a label is dark, the corresponding ON/OFF input or output is sensed to be active or ON.

GUIDER REMOTE

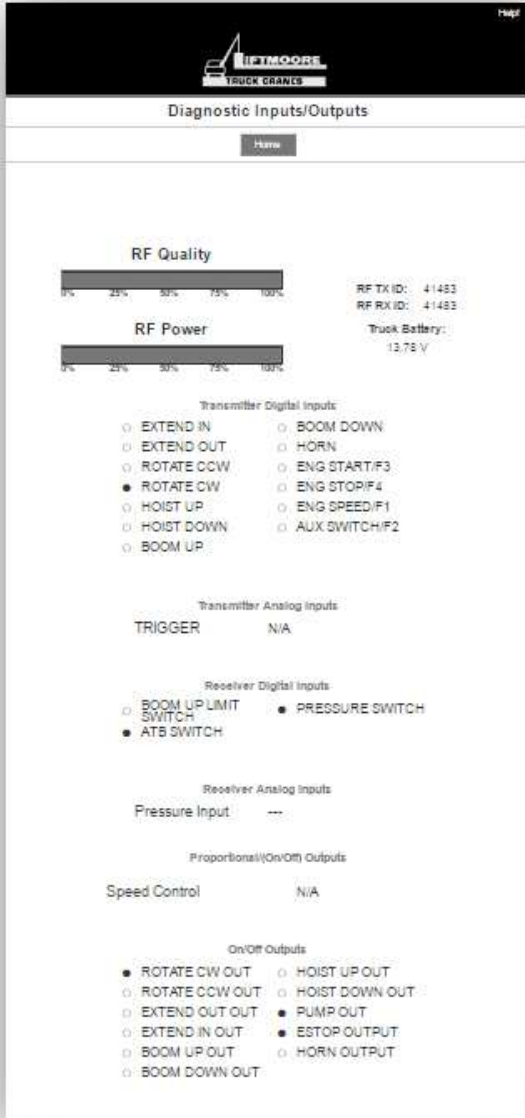

Diagnostics

CALIBRATION

To change the configuration of the unit, tap the Calibration icon.

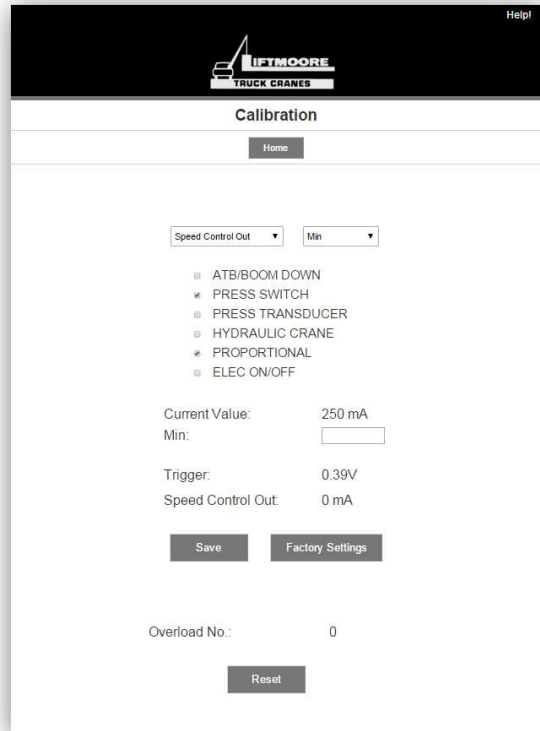

Calibration

The password to gain access to the calibration screens is 1262.

To adjust the Speed Control Proportional output's configuration, use the following procedure:

1. Select the parameter of the speed control output

GUIDER REMOTE

to change from the drop-down menu. Make sure PROPORTIONAL box below is checked.

- a. *Min* - Minimum amount of current to valve in mA
 - b. *Max* - Maximum amount of current to valve in mA
 - c. *Ramp Up* - Time in seconds to go from *Min* to *Max* current
 - d. *Ramp Down* - Time in seconds to go from *Max* current to no current
 - e. *Frequency* - Dither frequency to valves in Hz (Change affects all outputs)
2. Enter the new value in the box above the *Factory Setting* button
 3. Tap the *Save* button to send the setting to

memory

The lines to the right of the parameter indicate the present value of the output (if active), and trigger voltage on the transmitter

A series of checkboxes on the calibration page will change system functionality as follows:

1. *ATB/BOOM DOWN* - When the *ATB/BOOM DN* override is checked (enabled) and the *ATB SWITCH INPUT* is off, the *HOIST UP* and *EXTEND OUT* outputs are disabled. When the *ATB/BOOM DN* override function is unchecked, the *HOIST UP*, *EXTEND OUT*, and *BOOM DOWN* outputs are disabled when the *ATB SWITCH* input is off (input should

GUIDER REMOTE

be *ON* under normal conditions). The factory setting for the LS disables the ATB SWITCH override.

2. PRESS SWITCH -

Checking this box allows the OVERLOAD safety to be functional with a digital input (battery voltage). When the system senses the OVERLOAD input is off, the HOIST UP, EXTEND OUT, and BOOM DOWN functions are disabled (input should be *ON* under normal conditions). Note: either PRESS SWITCH or PRESS TRANSDUCER must be checked.

3. PRESS TRANSDUCER -

Checking this box disables PRESS SWITCH and allows the

OVERLOAD safety to be functional with an analog input (0-5VDC). Make sure to press SAVE after checking this box. When the system senses the OVERLOAD input is beyond the set value, the HOIST UP, EXTEND OUT, and BOOM DOWN functions are disabled. When this checkbox is selected, it will invoke a drop-down list with the following sensor calibration parameters:

a. Max Psi - The maximum pressure that the sensor will read (default is 5000 PSI)

b. OVL Psi - The pressure at and above which senses an OVERLOAD condition (default is

GUIDER REMOTE

3000 PSI)

c. Min Out - The minimum voltage the receiver will see from the sensor (default is 0.88V).

Equivalent to 0 PSI

d. Max Out - The maximum voltage the receiver will see from the sensor (default is 4.4V)

Equivalent to Max Psi

4. HYDRAULIC CRANE - Checking this box enables the pump output to turn ON with the HOIST UP and HOIST DOWN outputs. Make sure to press SAVE after checking this box. The default is unchecked where the pump output will remain off when the HOIST UP or DOWN

outputs are on. This feature is only available on the 3A3593A receiver.

5. ELEC ON/OFF - To change speed control output from proportional to on/off mode, check the Elec. ON/OFF box.

The number of times an overload condition is seen will be displayed below the Factory Settings button. Tap the Reset button to clear.

Tap the Factory Setting button to return all outputs to standard values. Tap Save to send these settings to memory. Tap Home to quit configuration and return to the main menu.

HISTOGRAM

Tap the Histogram icon to see a set of screens that show

GUIDER REMOTE

which error codes are active and how many times the specific error code has been active.

This feature can be used to troubleshoot machine wiring and other problems. Tapping the `Reset` button resets the error code counts. The password to reset error codes is 1713. Tap the `Home` button to return to the main menu.

Note: the GATE is not a precision measurement instrument. There may be delays.

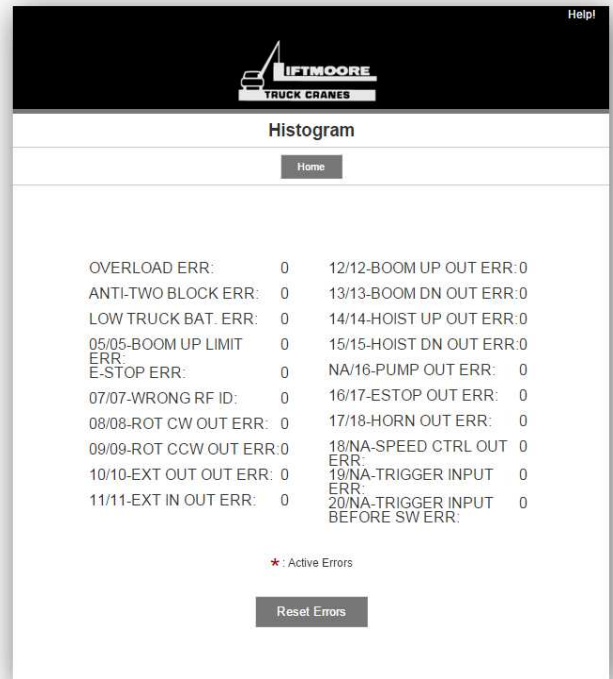

Histogram Page

SOFTWARE UPDATE

Use the `Choose File` button to select new software on your device with which to program the receiver. Software will be provided in the .kar format. Once the file is selected, press the `SUBMIT` button to upload the file.

Note: This feature does not work on Apple mobile or tablet products.

GUIDER REMOTE

Note: Do not turn the receiver or the GATE off during the upload process.

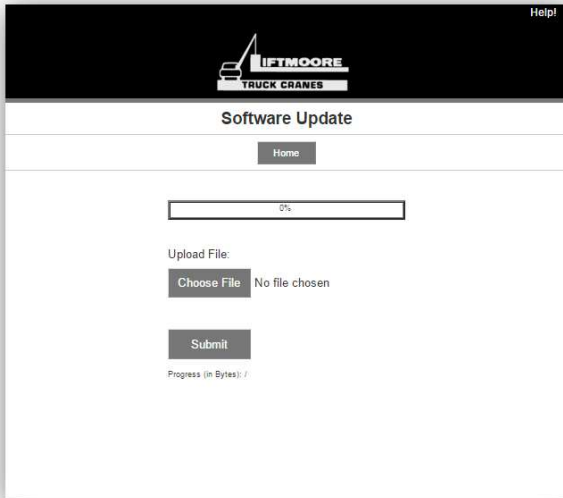

*Software Update
Page*

GATE CONFIGURATION

This page allows you to change the name (SSID) of the WiFi network you are connecting to. Factory settings will rename the Wi-Fi to its original name.

Note: After changing the name, the user needs to disconnect and reconnect to the new WiFi network.

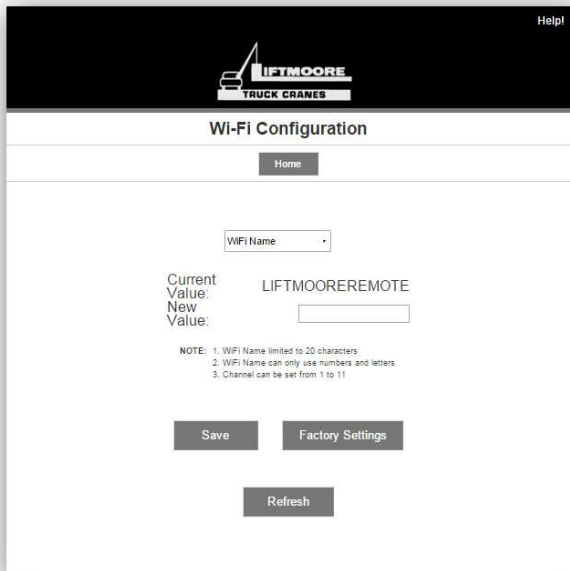

Gate Configuration Page

GUIDER REMOTE

WIRING CRANE RECEIVER

P1 - DEUTSCH DTM13-12PA

PIN	DESCRIPTION
1	GROUND
2	CANH
3	CANL
4	RS-232 TX
5	RS-232 RX
6	BOOM PRESSURE SWITCH INPUT
7	ANTI-TWO-BLOCK SWITCH INPUT
8	N/C
9	N/C
10	PROPORTIONAL SPEED CONTROL OUTPUT
11	HORN OUTPUT
12	POWER (9-30V)

P2 - DEUTSCH DTM13-12PA

PIN	DESCRIPTION
1	ROTATION CW OUTPUT
2	ROTATION CCW OUTPUT
3	EXTEND OUT OUTPUT
4	EXTEND IN OUTPUT
5	BOOM UP OUTPUT
6	BOOM DOWN OUTPUT
7	HOIST UP OUTPUT
8	HOIST DOWN OUTPUT
9	N/C
10	E-STOP OUTPUT
11	N/C
12	BOOM UP LIMIT SWITCH INPUT

GUIDER REMOTE

WIRING ENGINE RECEIVER

P1:12 PIN DEUTSCH DTM13-12PA

PIN#	DESCRIPTION
1	GROUND
2	NO CONNECTION
3	NO CONNECTION
4	PROGRAMMING PIN
5	ENGINE SPEED SELECT
6	NO CONNECTION
7	NO CONNECTION
8	AUXILIARY OUTPUT
9	ENGINE START OUTPUT
10	ENGINE RUN OUTPUT
11	ENGINE SPEED OUTPUT
12	POWER (9 TO 35 VDC)



FOR MAINTAINED ENGINE SPEED OUTPUT LEAVE OPEN
FOR MOMENTARY ENGINE SPEED OUTPUT SHORT TO 12 VOLT

TRANSMITTER PORT

- A POWER**
- B GROUND**
- C CAN HIGH**
- D CAN LOW**
- E NO CONNECTION**

GUIDER REMOTE

ROUTINE MAINTENANCE

Clean transmitter regularly with a damp cloth and mild detergent.

Inspect electrical wiring for wear points or other damage. Repair as required.

Inspect all connections for looseness or corrosion. Tighten and/or "seal" as necessary.

Guider pendants that include a trigger control should be cleaned periodically by blowing air around the trigger area to remove any debris that would prevent proper operation. Apply a light machine oil to the point of rotation when clean.

MAINTENANCE PRECAUTIONS

When performing any inspection

or maintenance work on the remote system, always exercise care to prevent injury to yourself and others or damage to the equipment. The following are general precautions, which should be closely followed in carrying out any maintenance work.

Do not have hydraulic power available to the valves when performing electrical tests.

Never operate or test any function if any person is in an area where they could be hurt by being hit or squeezed by the hydraulic equipment.

Turn power off before connecting or disconnecting valve coils or other electrical loads.

GUIDER REMOTE

TROUBLESHOOTING

This next section provides basic operator level troubleshooting for the GUIDER REMOTE system. If, after following these instructions, the system still does not function, contact your sales representative for further instructions or servicing.

GUIDER REMOTE

TROUBLESHOOTING CHART

<i>PROBLEM</i>	<i>SOLUTION</i>
No functions work	<ol style="list-style-type: none">1. Verify transmitter power source – battery, CAN cable, external supply, etc2. Verify that receiver control module power source is present at its input connector3. Check for proper system ground4. Check the receiver or control module LED status display for functionality or errors5. Check the hydraulic system
Certain functions do not work	<ol style="list-style-type: none">1. Check the wiring and connections from the receiver control module to the control module to the valve coil for the particular function that does not work2. Check the receiver control module LED status display for possible fault or error indication3. Check the hydraulic system4. Check the electrical system
Functions operate intermittently	<ol style="list-style-type: none">1. Check for loose connections at the valve coil2. Check the receiver control module LED status display for functionality or errors3. Check the receiver antenna for damage and possible obstructions4. Check the hydraulic system

GUIDER REMOTE

ERROR CODES CRANE RECEIVER

ERROR	PROBABLE CAUSE
EC01	RF COMMUNICATION ERROR
OVLD	OVERLOAD CONDITION
ATB	ANTI-TWO BLOCK (ATB SWITCH OFF)
RLV	LOW INPUT VOLTAGE TO RECEIVER
EC05	BOOM UP LIMIT (BOOM UP LIMIT ON)
ESTP	E-STOP CONDITION
EC07	WRONG RF ID
EC08	ROTATE CW OUTPUT ERROR
EC09	ROTATE CCW OUTPUT ERROR
EC10	EXTEND OUT OUTPUT ERROR
EC11	EXTEND IN OUTPUT ERROR
EC12	BOOM UP OUTPUT ERROR
EC13	BOOM DOWN OUTPUT ERROR
EC14	HOIST UP OUTPUT ERROR
EC15	HOIST DOWN OUTPUT ERROR
EC16	E-STOP OUTPUT ERROR
EC17	HORN OUTPUT ERROR
EC18	PROPORTIONAL OUTPUT ERROR
EC19	TRIGGER INPUT ERROR
EC20	TRIGGER INPUT BEFORE SW ERROR

Error code explanations:

EC01	Transmitter is off Transmitter went to sleep mode Interference in RF communication link
OVLD	Overload condition based on Gate setting is present
ATB	Anti-Two Block condition present
RVL	System voltage is below 11V (12V system)
EC05	Boom Limit input active
ESTP	E-STOP button is pressed on the transmitter

GUIDER REMOTE

- EC07** Transmitter and receiver are not synchronized
- EC08-18** Short or open load/coil on output
- EC19** No voltage present on trigger in transmitter
- EC20** Trigger was pulled on transmitter before switch was activated

ERROR CODES ENGINE RECEIVER

ERROR CODE	PROBABLE CAUSE
1	RADIO SIGNAL PROBLEM
2	FAULTY CIRCUIT TO ENGINE SPEED COIL
3	WRONG TRANSMITTER OR BAD ID

Error code explanations:

- 1** Transmitter is off
Transmitter went to sleep mode
Interference in RF communication link
- 2** Short or open load/coil on output
- 3** Transmitter and receiver are not synchronized

GUIDER REMOTE

PARTS LIST

<i>PART NUMBER</i>	<i>DESCRIPTION</i>
3B1062A	RADIO TRANSMITTER
3B1063B	CRANE RADIO RECEIVER
3B1064A	ENGINE RADIO RECEIVER
020-506-0250	CAN ADAPTOR CABLE 25'
020-506-0120	RS-232 ADAPTOR CABLE
010-001-2200	7.2V RECHARGEABLE BATTERY
B20032B	CHARGER, 12 VDC CIGARETTE LIGHTER PLUG
B20072A	FAST CHARGER SUPPLY, 110V AC WALL
3A3599B	OPTIONAL GATE WITH SOFTWARE

There are no user-serviceable parts inside the transmitter or the receiver. Return the units for service.

Note: For operation with negative ground systems only.

WARNING:

The GUIDER REMOTE must be operated in compliance with all applicable safety regulations, rules, and practices. Failure to follow required safety practices may result in death or serious injury.

The information, specifications, and illustrations in this manual are those in effect at the time of printing. We reserve the right to change specifications or design at any time without notice.

GUIDER REMOTE

TRANSMITTER PICTORIAL

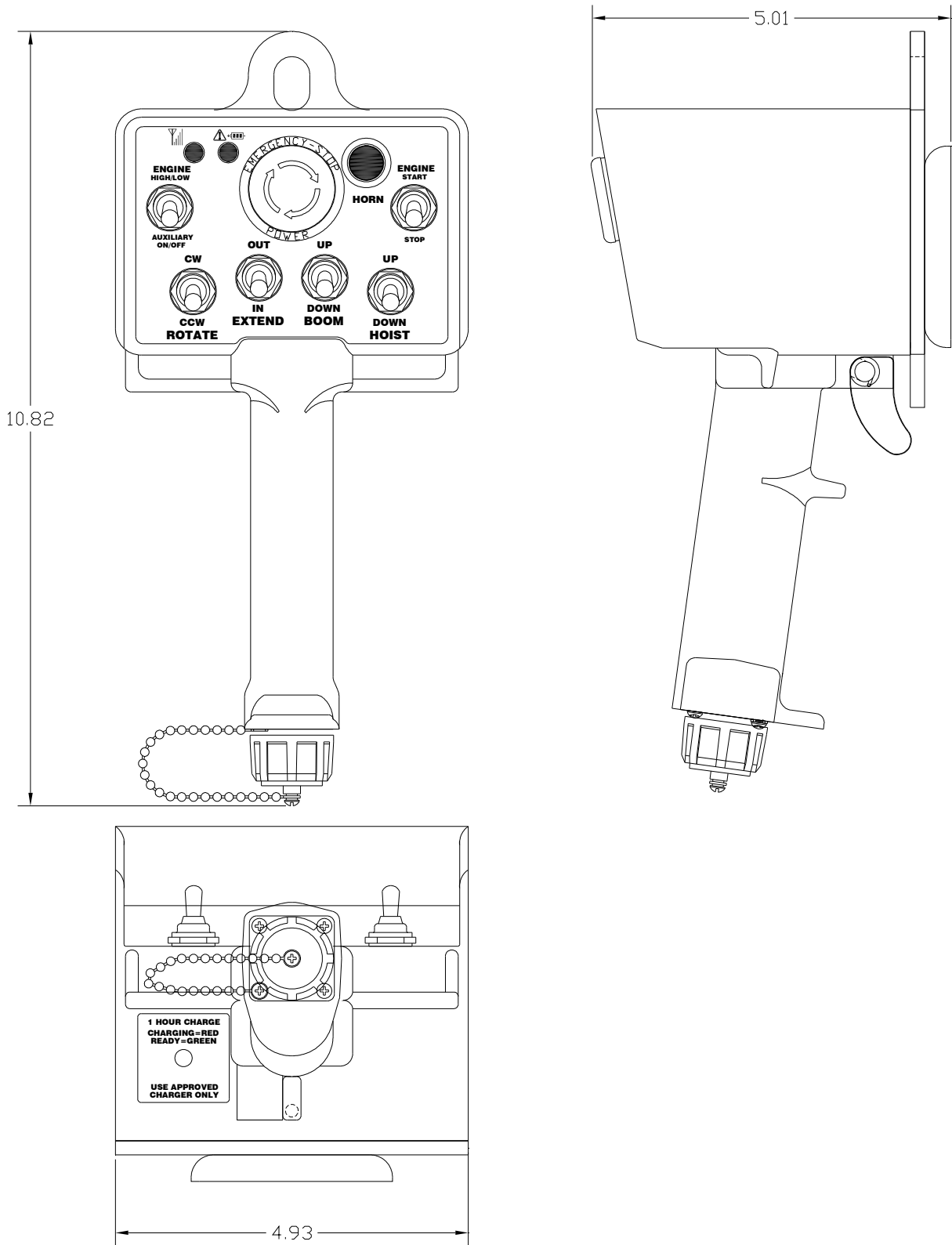

GUIDER REMOTE

CRANE RECEIVER PICTORIAL

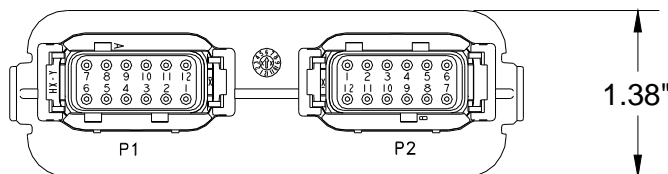
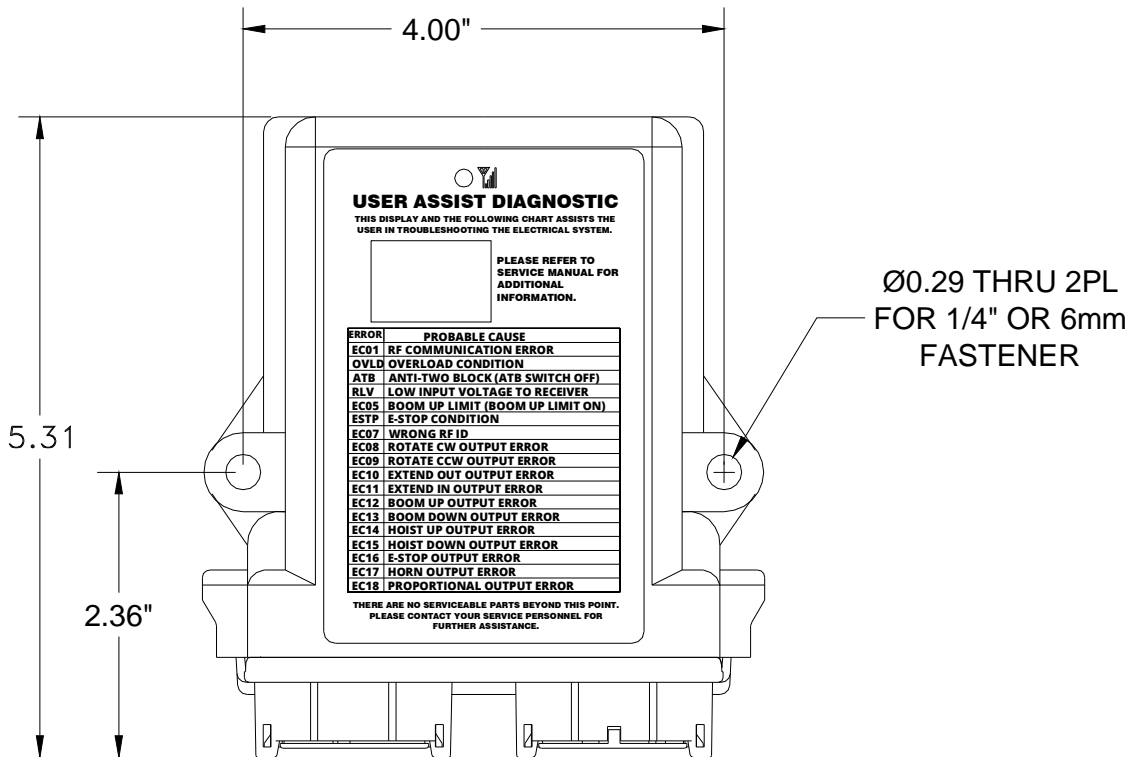
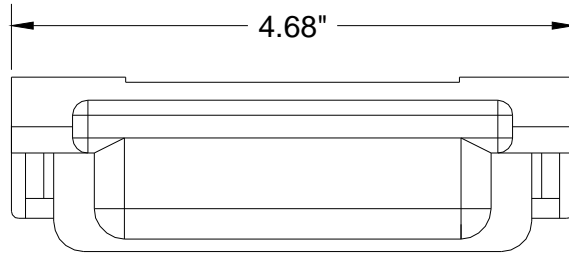

GUIDER REMOTE

ENGINE RECEIVER PICTORIAL

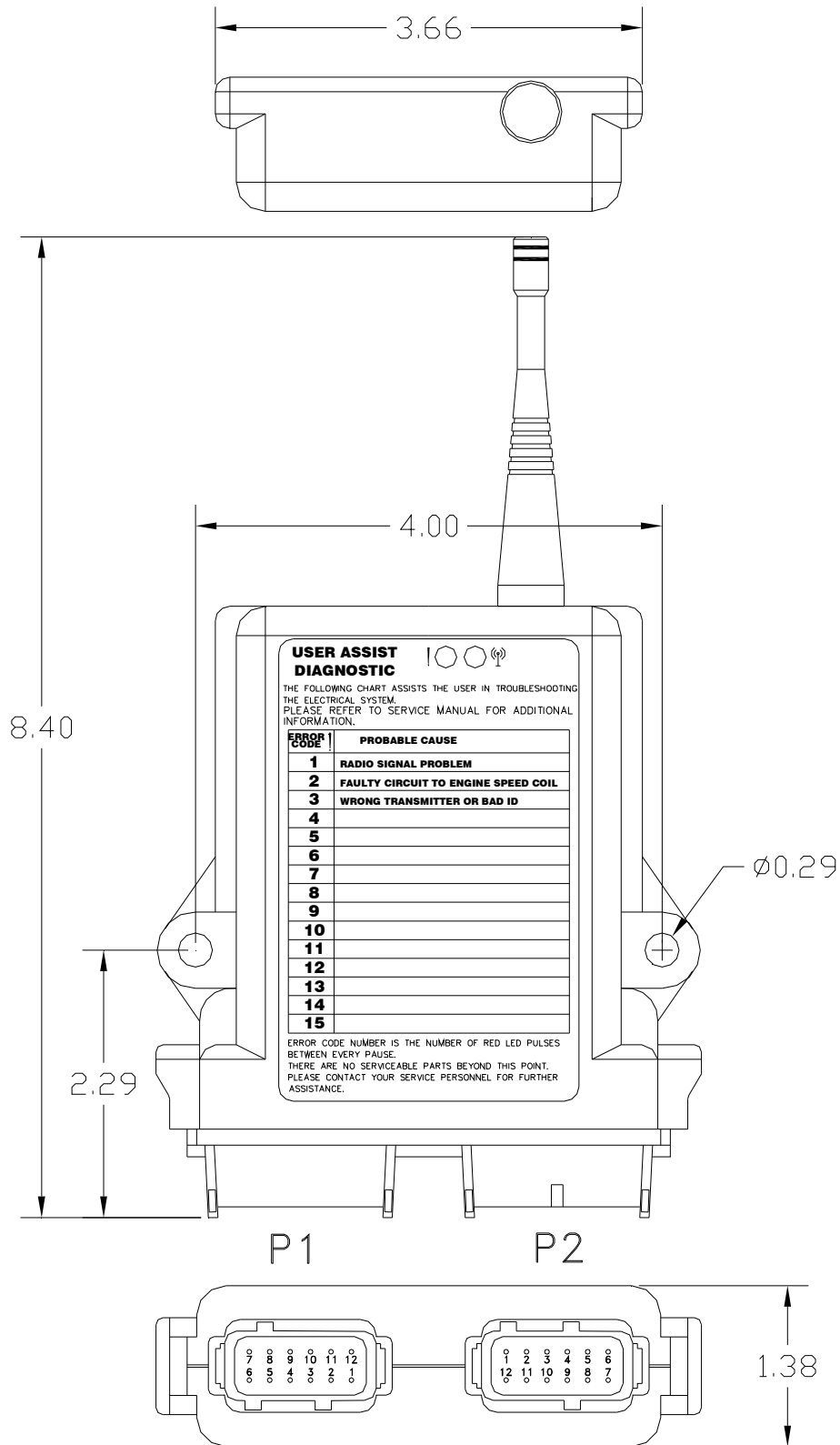

GUIDER REMOTE

SPECIFICATIONS

FCC ID: P4U-VRTS

Industry Canada Certification Number: 4534A-VRTS

EQUIPMENT CLASS: PART 15 SPREAD SPECTRUM TRANSMITTER

TRANSMITTER

Power supply	7.2V NiMH Rechargeable Battery
Fast charger temperature range	+5°C to +60°C
Operating temperature - Radio	-40°C to +85°C
Storage temperature.....	-40°C to +100°C
RF Frequency	902-928 MHz
RF Transmit power (EIRP).....	33 mW
LCD display operating range (if equipped)	-20°C to +70°C
Vibration	3G to 200Hz
Shock.....	50G
NEMA	12

RECEIVER

Power supply voltage	9-30VDC
Operating temperature	-40°C to +85°C
Storage temperature.....	-40°C to +100°C
Outputs	5.0A max each, sourcing, 20A system max
Digital Inputs (when equipped)	supply voltage
Analog Inputs (when equipped)	0-5VDC/4-20mA
RF Frequency	902-928 MHz)
Vibration	3G to 200Hz
Shock.....	100G
NEMA	4X

GUIDER REMOTE

INSTRUCTION TO THE USER

This equipment has been tested and found to comply with the limits for a class B digital device, pursuant to part 15 of the FCC Rules. These limits are designed to provide reasonable protection against harmful interference in a residential installation. This equipment generates radio frequency energy and if not installed and used in accordance with the instructions, may cause harmful interference to radio communications. However, there is no guarantee that interference will not occur in a particular installation. If this equipment does cause harmful interference to radio or television reception, which can be determined by turning the equipment off and on, the user is encouraged to try to correct the interference by one or more of the following measures:

- * Reorient or relocate the receiving antenna.
- * Increase the separation between the equipment and receiver.
- * Connect the equipment into an outlet on a circuit different from that to which the receiver is connected.
- * Consult the dealer or an experienced radio/TV technician for help.

This equipment has been certified to comply with the limits for a class B computing device, pursuant to FCC Rules. In order to maintain compliance with FCC regulations, shielded cables must be used with this equipment. Operation with non-approved equipment or unshielded cables is likely to result in interference to radio and TV reception. The user is cautioned that changes and modifications made to the equipment without the approval of manufacturer could void the user's authority to operate this equipment.

DEUTSCH CONNECTIONS & PINS



FEMALE'S

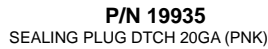

MALE'S

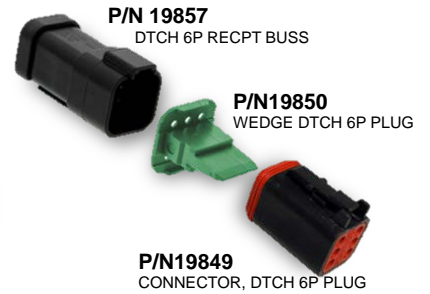
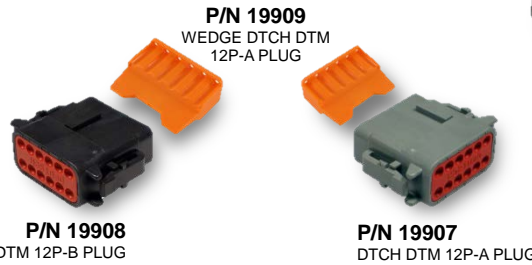
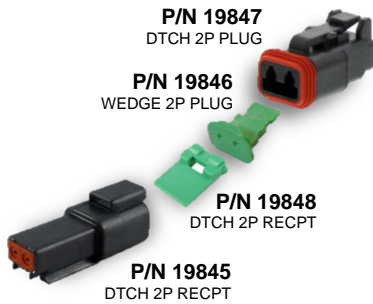

F2435-0
06/16/16
I:FORMS

HOUSTON, TEXAS
FAX: (800) 824-5559 (USA & Canada)
FAX: (713) 688-6324
PHONE: (713) 688-5533
www.liftmoore.com

SECTION 3 CRANE SPECIFICATIONS

MODEL 4000X CRANES

MOMENT RATING	16 000 FT-LBS
MAX SINGLE LINE LOAD	2 000 LBS
MAX DOUBLE LINE LOAD	4 000 LBS

LIFTING CAPACITIES AT VARIOUS LOAD RADII:

LOAD RADIUS (FT)	CAPACITY (LBS)
≤ 4	4000
6	2666
8	2000
10	1600
12	1333
14	1142
16	1000
18	889
20	800

POWERED FUNCTIONS AND APPROXIMATE TIMES:

WINCH	UP: 5 s	DOWN: 5 s	1 REVOLUTION
BOOM ELEVATION	UP: 18 s	DOWN: 17 s	
BOOM EXTENSION	OUT: 30 s	IN: 30 s	
ROTATION	90° 13 s		

HYDRAULICS:

RELIEF SETTING	1800 PSI
FLOW	0.95 GPM AT 2000PSI

ELECTRICAL:

VOLTAGE	12 VDC
CIRCUIT BREAKER	150 AMP
CONTROL CIRCUIT FUSE	15 AMP

NOTE: FUNCTION TIMES ARE BASED ON THESE INPUT VALUES



F1509-B
12/18/15

HOUSTON, TEXAS
FAX: (800) 824-5559 (USA & Canada)
FAX: (713) 688-6324
PHONE: (713) 688-5533
www.liftmoore.com

PERIODIC MAINTENANCE SCHEDULE		
MODEL 4000 CRANES		
BOLTS		
MOUNTING BOLTS	$\frac{3}{4}$ - 10 GRADE 8 TORQUE 380 FT-LBS DRY	EVERY 4 MONTHS
LUBRICATION		
LUBE POINTS	SEE DRAWING 50460	EVERY OTHER WEEK
HYDRAULIC FLUID	STANDARD Chevron AW Hydraulic Oil 46 or equivalent SAE 15 weight oil COLD WEATHER AW 32 or equivalent SAE 10 weight oil	CHECK DAILY, FILL AS NEEDED
ROTATION WORM/GEAR	Oil Center Research PM 600 Military grease or equivalent Benton Based Grease NLGI Grade 2	EVERY 8 HRS OR EVERY MONTH



CRANE LUBRICATION POINTS

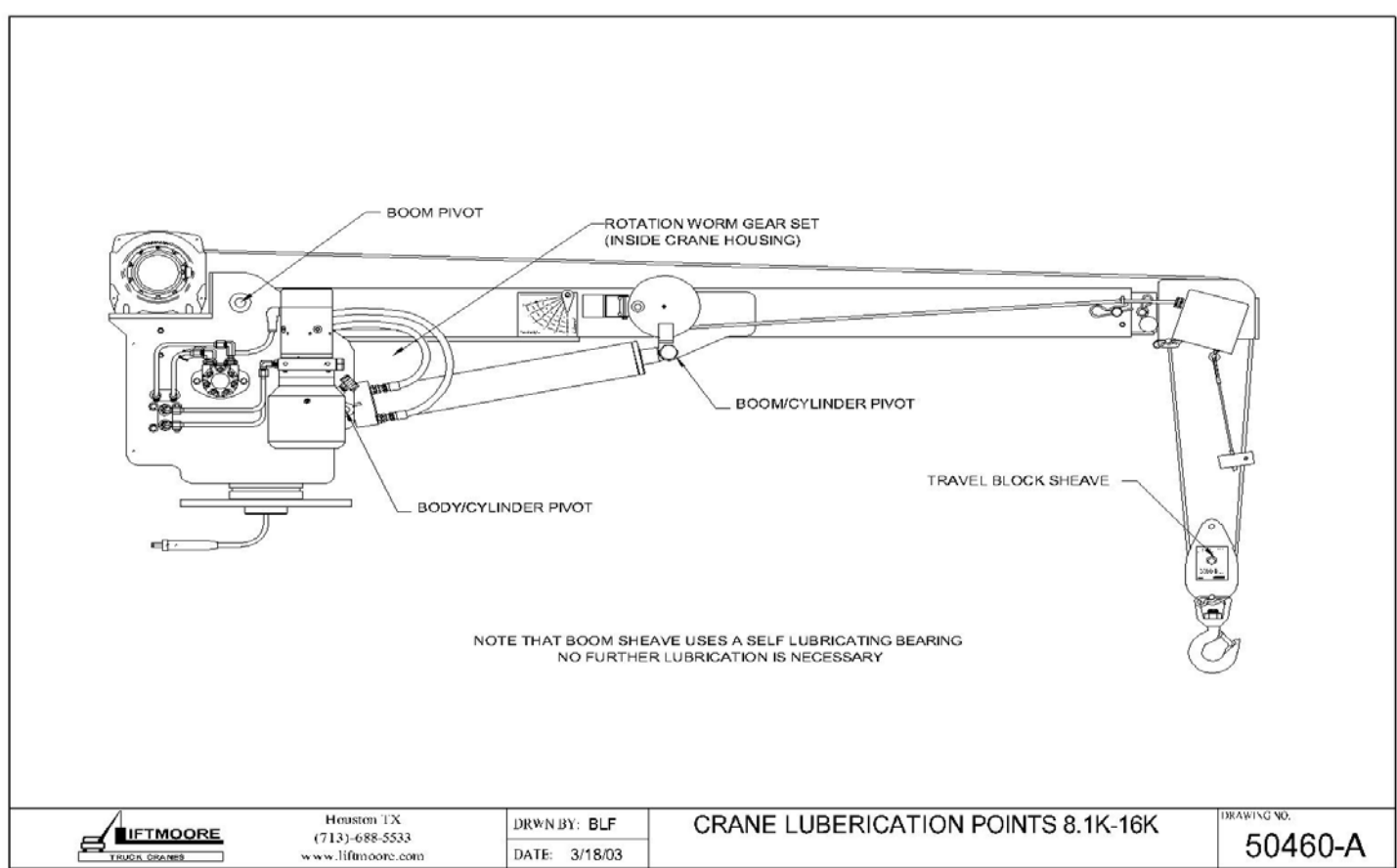

F1509-B
12/18/15

HOUSTON, TEXAS
FAX: (800) 824-5559 (USA & Canada)
FAX: (713) 688-6324
PHONE: (713) 688-5533
www.liftmoore.com

THIS PAGE INTENTIONALLY LEFT BLANK



F1509-B
12/18/15

HOUSTON, TEXAS
FAX: (800) 824-5559 (USA & Canada)
FAX: (713) 688-6324
PHONE: (713) 688-5533
www.liftmoore.com

LIST FOR BOX, CRANE PARTS 4000X-16

Items with * have detailed DWG's.

P/N 28084 - BOX, CRANE PARTS 4000X-16 WI
L.S. ATB, E-STOP, HORN 23872 WINCH

- 1) P/N 28085 - MANUAL, CRANE 4000X-161pc
- 2) P/N 25866 - WIRE, BATTERY #1 X 30' W\MECON.....1pc
- 3) P/N 26084 - WIRE, GROUND 1/0 X 3' LONG.....1pc
- 4) P/N 30760 - PIN, HITCH 0.75 X 4.50 W/H-PIN1pc
- 5) P/N 32459 - SCREW, HHC 0.75-10 X 3.50 GR84pcs
- 6) P/N 31442 - WASHER, LOCK 0.75 GR5 PLATED.....4pcs
- 7) P/N 34185 - NUT, HEX 0.75-10 GR8 PLATED4pcs
- 8) *P/N 22532 - BLOCK, TRAV ASSY 4.0K lbs/4.0D.1pc
- 9) P/N 16878 - BREAKER, CIRCUIT 150 AMP.....2pcs
- 10) P/N 16915 - TERMINAL, LUG #1 GA 0.25 DIA.....2pcs
- 11) P/N 30766 - SWITCH, DISCONNECT.....1pc
- 12) P/N 17010 - BRACKET, SWITCH MNT. ELE. CRN.....1pc
- 13) P/N 17063 - TERMINAL, LUG #1 GA 0.37 DIA.....2pcs
- 14) P/N 18600 - PLATE, CRANE-TRUCK STABILITY CHART.....1pc
- 15) P/N 22433 - INSTALLATION INTS. 40001pc
- 16) P/N 28855 - DECAL, LOAD CAPACITY 16,000...1pc
- 17) P/N 23144 - LEVEL & TAPE ASSEMBLY.....1pc
- 18) P/N 27490- SWITCH, DISCONNECT COVER PLATE.....1pc



F2422-0
5/27/16

HOUSTON, TEXAS
FAX: (800) 824-5559 (USA & Canada)
FAX: (713) 688-6324
PHONE: (713) 688-5533
www.liftmoore.com

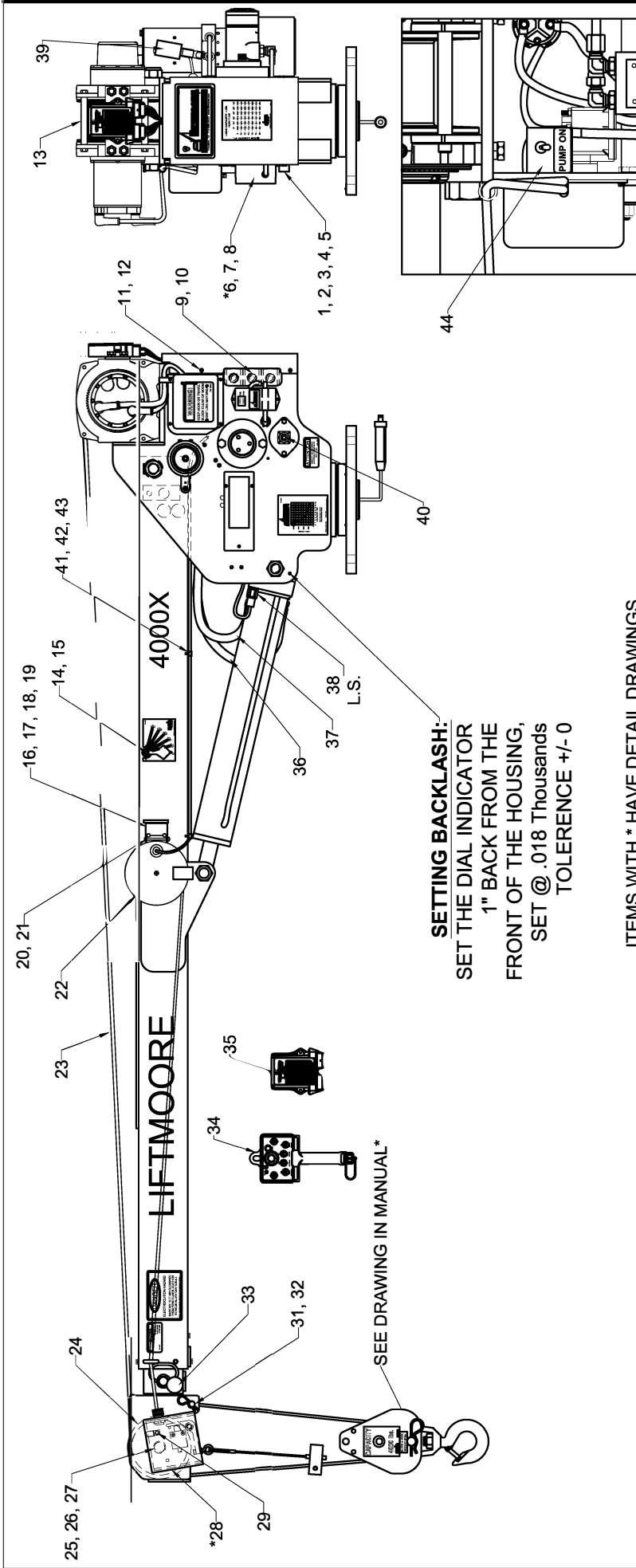

SETTING BACKLASH:
 SET THE DIAL INDICATOR
 1" BACK FROM THE
 FRONT OF THE HOUSING,
 SET @ .018 Thousands
 TOLERANCE +/- 0

SEE DRAWING IN MANUAL*

ITEMS WITH * HAVE DETAIL DRAWINGS

#	PN	DESCRIPTION	QTY	#	PN	DESCRIPTION	QTY	#	PN	DESCRIPTION	QTY
1	28039	EW,DTCH ELEC 3200REE W/E-STOP	1	18	31110	WASHER, FLAT 0.25 GR5 PLATED	2	36	32969	HOSE, HYD #4 44.00"	1
2	30457	SCREW, HHC 0.25-20 X 0.75 GR5	2	19	30457	SCREW, HHC 0.25-20 X 0.75 GR5	2	37	32968	HOSE, HYD #4 37.50"	1
3	31110	WASHER, FLAT 0.25 GR5 PLATED	1	20	33410	SCREW, MH RD 10-24 X 3.00	1	38	25868	SWITCH, PRES ASSY 1550PSI DTCH	1
4	30833	NUT, HEX NYLOC 0.25-20 GR2	1	21	33409	NUT, HEX NYLOC 10-24 GR2	1	39	23123	PRESSURE GAUGE, 0-3000 PSI	1
5	30989	SCREW, HWHMS #8 X 0.50	1	22	25885	REEL, CORD 20 FT ASSY DTCH	1	40	20522	LANYARD, 4.00 IN FOR DUST CAP	1
6	27810	METER, DIGITAL VOLT/AMPS	1	23	33197	ROPE, WIRE 0.25 X 75' W/THB&LP	1	41	26582	SCREW, SOC HD 0.25-20 X 0.37 SS	3
7	17164	SCREW, SOC HD 10-24 X 0.625 SS	2	24	33058	SHEAVE ASSY 5.90PD X 0.25 ROPE	1	42	24960	CLAMP, HOSE SUPPORT 0.25	3
8	32639	WASHER, LOCK #10 GR 2	2	25	34468	SCREW, SHEAVE SINGLE 1-8 3.25	1	43	30889	WASHER, LOCK 0.25 GR5 PLATED	3
9	24432	VALVE ASSY 4W/3P/12V/OC DTCH	3	26	31258	WASHER, FLAT 1.00 SAE GRADE 8	1	44	17151	SWITCH, PUMP-ON ASSY	1
10	30956	SCREW, SOC HD 10-24 X 2.00	12	27	30838	NUT, HEX NYLOC 1.00-8 GRADE 5	1	45	MH*01143	CAP, BREATHER 3/4 NPT-MONARCH	1
11	25111	COVER, BACK 4000 PLASTIC	1	28	22908	ATB ASSY, DEUTSCH CONNECTOR	1	NOT SHOWN:			
12	32589	SCREW, HWHMS 0.25-20 X 0.75	4	29	32957	CLAMP, HOSE SUPPORT 0.62 ID	1	19847	19847	CONNECTOR, DTCH 2P PLUG	1
13	70022	WEDGE, WIRE ROPE ANCHOR	1	31	22804	PIN, CLEVIS 0.56 X 4.00 PLATED	1	19845	19845	CONNECTOR, DTCH 2P RECEPT	1
14	22394	PENDULUM, LOAD RADIUS DIA. HD	2	32	31603	CLIP, HAIRPIN 0.50 - 0.62	1	19846	19846	WEDGE, DEUTSCH 2P PLUG	1
15	31017	SCREW, SHOULDER 0.31-18 X 0.75	2	33	23197	STOP, BOOM INNER ASSY STD.	1	19848	19848	WEDGE, DEUTSCH 2P RECEPT	1
16	70012	BRACKET, CORD REEL	1	34	26682	CONTROL, FM TRANS X DRA KTG	1	21029	21029	PLATE, SERIAL 1640X & 4000X-20	1
17	30833	NUT, HEX NYLOC 0.25-20 GR2	2	35	26683	CONTROL, FM REC X KTG	1	28884	28884	DECAL KIT 4000X	1

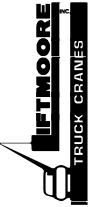

Houston TX
 (713)-688-5533
 www.liftmoore.com

DRWN BY: JE
 DATE: 5/26/16

CRANE ASSEMBLY 4000X-16
 WIRELESS CONTROLS, ROTATION ADJUST

DRAWING NO.
28083

REV.: C
 DATE: 4/15/19

COMPLETE PFORM122: Function Check list for Pendant on Test Box

TRANSMITTER AND RECEIVERS SYNCHRONIZATION

1. TURN THE TRANSMITTER AND RECEIVER OFF
2. PRESS AND HOLD BOOM UP AND EXTEND IN SWITCHES,
3. WHILE HOLDING SWITCHES, RELEASE THE E-STOP
4. RELEASE THE SWITCHES. LED'S SHOULD BE LINK AT THIS POINT
5. APPLY POWER TO THE RECEIVER. GREEN LED SHOULD GO FROM STEADY TO BLINKING ON THE TRANSMITTER
6. TEACH COMPLETE

TRANSMITTER AND RECEIVERS ARE PROGRAMMED TO FORM A MATCHED SET SO THAT A TRANSMITTER ONLY OPERATES ONE CRANE. IF EITHER PART IS REPLACED, THE RECEIVER MUST BE PROGRAMMED TO THE TRANSMITTER USING A TEMPORARY WIRING HARNESS AVAILABLE FROM LIFTMOORE.

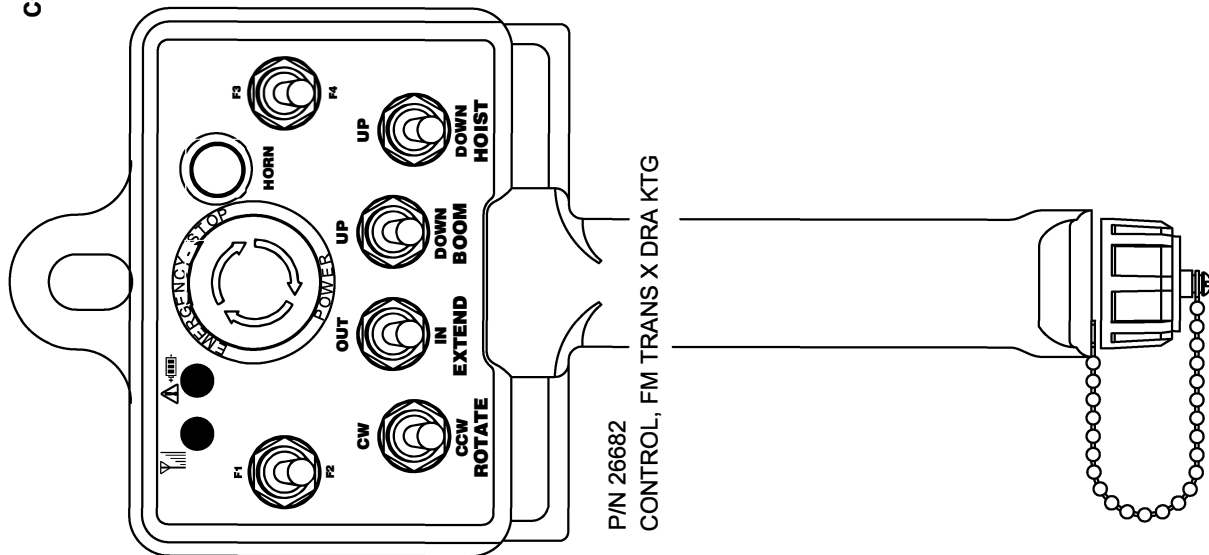

P/N 26682
CONTROL, FM TRANS X DRA KTG

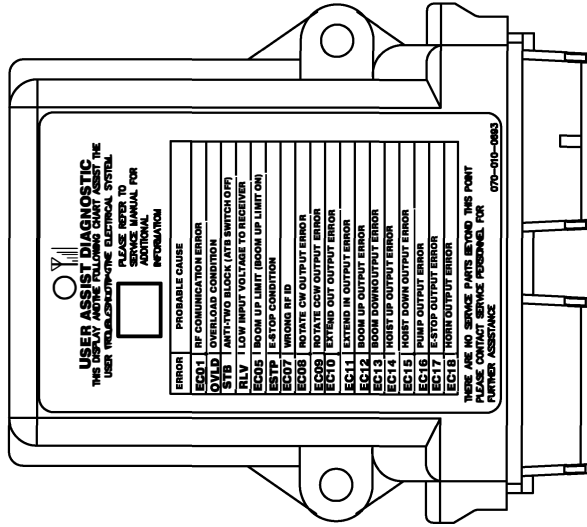

P/N 26683
CONTROL, FM REC X KTG

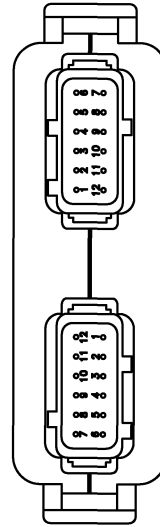

NOT SHOWN: P/N 20185 WIRE, CTRL FM TEATHER 5P PLUG P/N 20186 CAR CHARGER, FM TRANS

OPTIONAL: P/N 24510 INTERNATIONAL WALL CHARGER 110V

P1:12 PIN DEUTSCH DTM13-12PA

PIN#	DESCRIPTION	COLOR
1	GROUND	BRN
2	CAN HIGH	WHT
3	CAN LOW	GRN
4	RS-232 TX	
5	RS-232 RX	
6	BOOM PRESSURE SWITCH INPUT	GRY
7	ANTI-TWO-BLOCK SWITCH INPUT	BLK
8	NO CONNECTION	
9	NO CONNECTION	
10	NO CONNECTION	
11	HORN OUT PUT	BLU/BLK
12	POWER (9 TO 30 VDC)	RED

P2:12 PIN DEUTSCH DTM13-12PB

PIN#	DESCRIPTION	COLOR
1	ROTATION CW OUTPUT	RED
2	ROTATION CCW OUTPUT	RED/BLK
3	EXTENSION IN OUTPUT	WHT
4	EXTENSION IN OUTPUT	ORG/BLK
5	BOOM UP OUTPUT	GRN
6	BOOM DOWN OUTPUT	YEL
7	HOIST UP OUTPUT	PUR
8	HOIST DOWN OUTPUT	BLK
9	PUMNP OUTPUT	WHT/BLK
10	E-STOP OUTPUT	WHT/BUJ
11	NO CONNECTION	
12	BOOM UP LIMIT SWITCH INPUT	WHT

Houston TX
(713)-688-5533
www.liftmoore.com

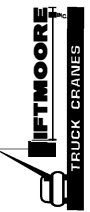

DRWN BY: AT

DATE: 12/11/15

CONTROL, FM ASSY X DRA KTG
GUIDER, HORN, E-STOP, DRA

DRAWING NO.

26946-B

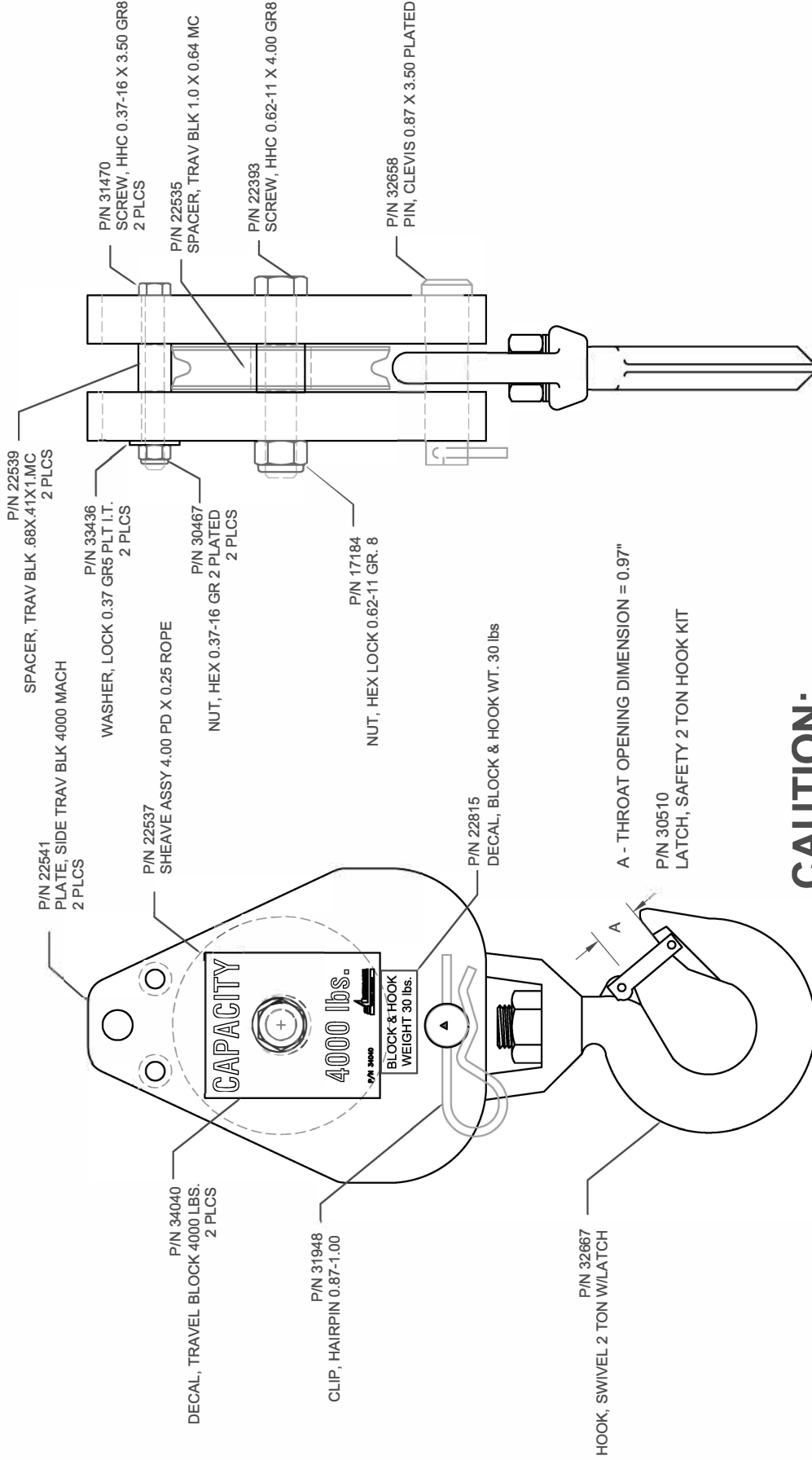

CAUTION:

NEVER USE A HOOK WHOSE THROAT OPENING HAS BEEN INCREASED, OR WHOSE TIP HAS BEEN BENT MORE THAN 10 DEGREES OUT OF PLANE FROM THE HOOK BODY, OR IS IN ANY WAY DISTORTED OR BENT.

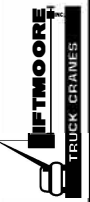

Houston TX
(713)-688-5533
www.liftmoore.com

DRWN BY: JC
DATE: 6/23/08

BLOCK, TRAV ASSY 4.0K lbs/4.0D
4.00PD X 0.25 ROPE; 4K LBS

DRAWING NO.

22532-D

NOTE: WIRE SHOULD BE SECURED TO SHEAVE BOLT TO ENSURE THAT IT DOES NOT INTERFERE WITH THE LEVER

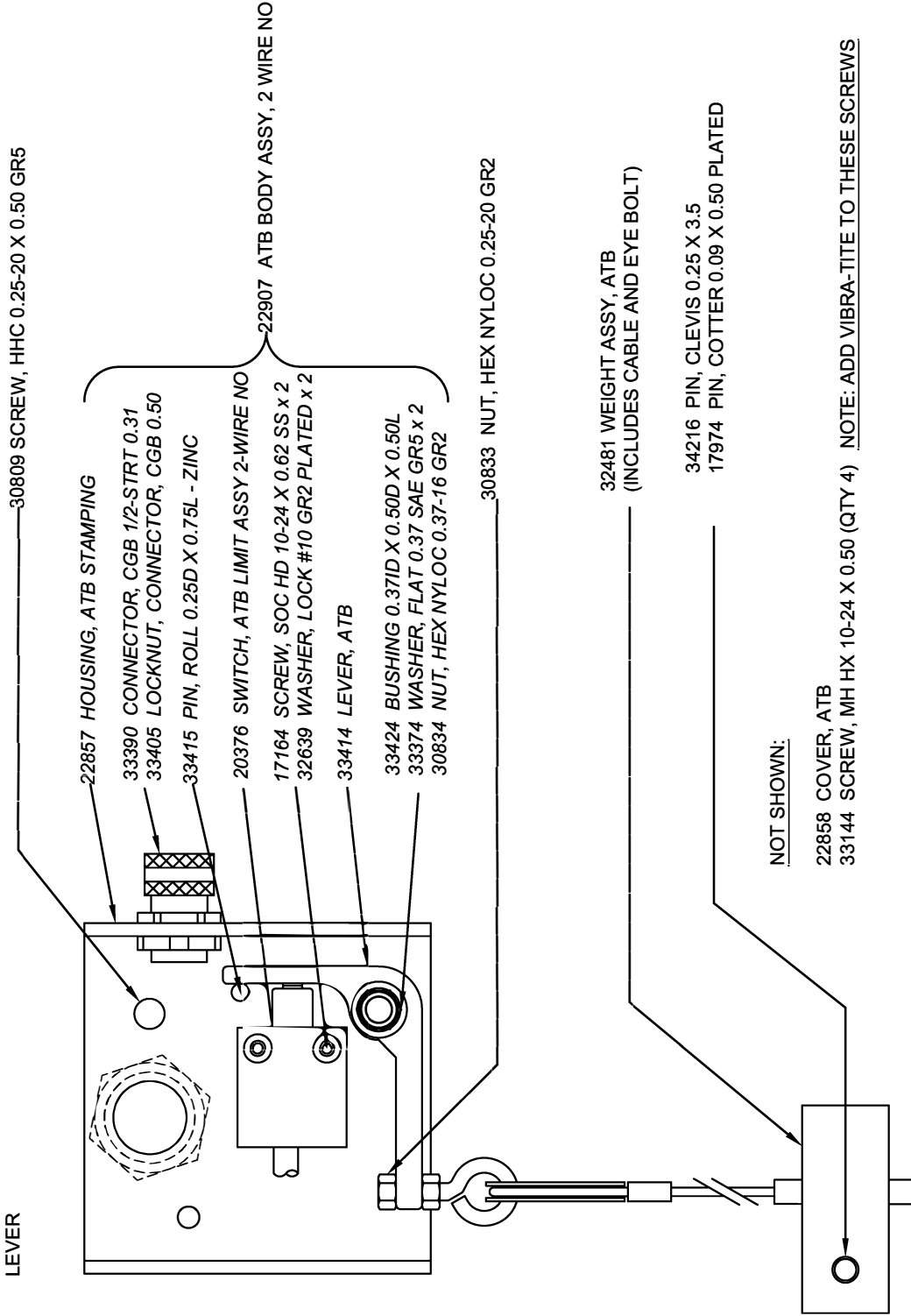

Houston TX
(713)-688-5533
www.liftmoore.com

DRWN BY: JC
DATE: 07/02/09

ATB ASSY, DEUTSCH CONN
TWO-WIRE NORMAL OPEN; LEFT SIDE

DRAWING NO.

22908-B

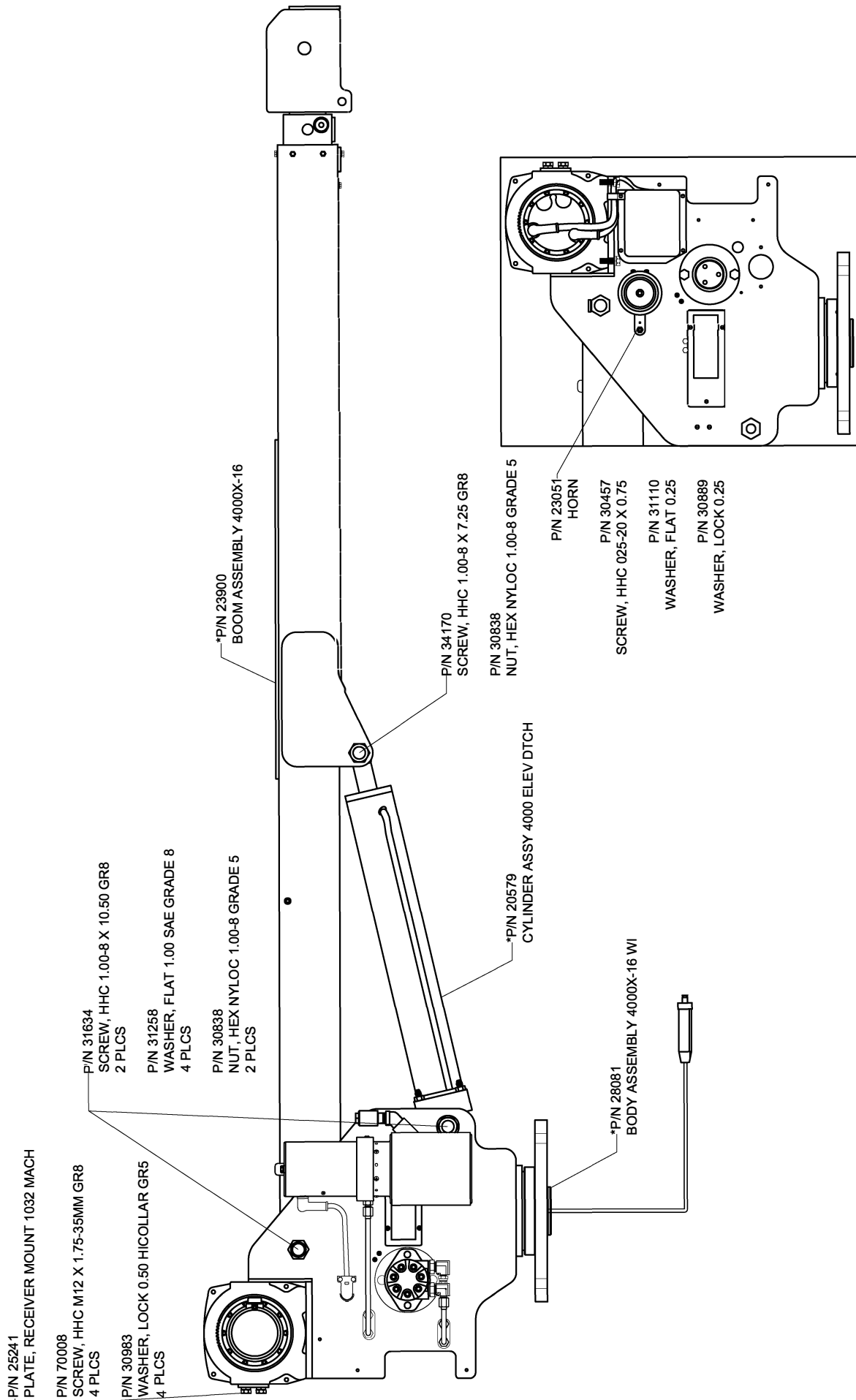

ITEMS WITH * HAVE DETAIL DRAWINGS

DRAWING NO.
28082-A

BOOM-BODY ASSY 4000X-16 WI
L.S. ATB, E-STOP, HORN, 23872 WINCH

DRWN BY: JE
DATE: 5/25/16

Houston TX
(713)-688-5533
www.liftmoore.com



REPLACEMENT PARTS FOR CYLINDER	
DESCRIPTION	PART NUMBER
SEAL KIT	TM*SK-00138
COUNTERBALANCE VALVE	PP-00259

SWITCH, PRES ASSY 1550PSI DTCH
(NOT PART OF ASSEMBLY)
SEE CRANE ASSEMBLY DRAWING FOR PART NUMBER

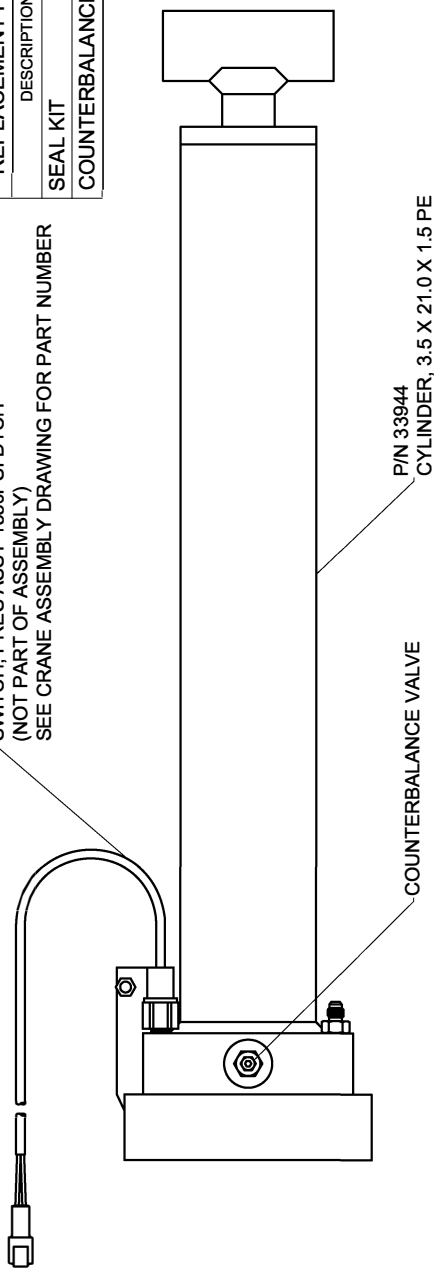

P/N 32400
ADAPTER, 4MJ-6MO
2 PLCS

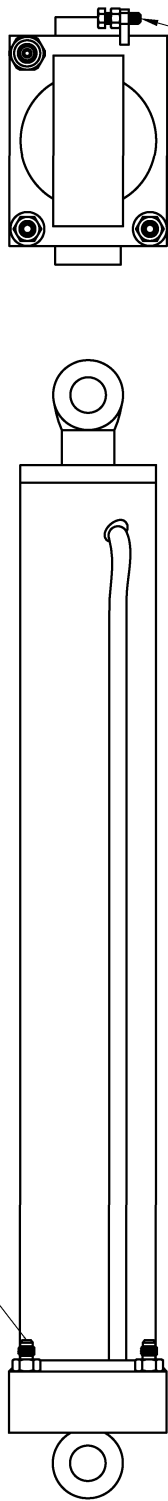

Houston TX
(713)-688-5533
www.liftmoore.com



CYLINDER ASSY 4000 ELEV DTCH

DRAWING NO.

20579-D

DRWN BY: JC

DATE: 04/27/09

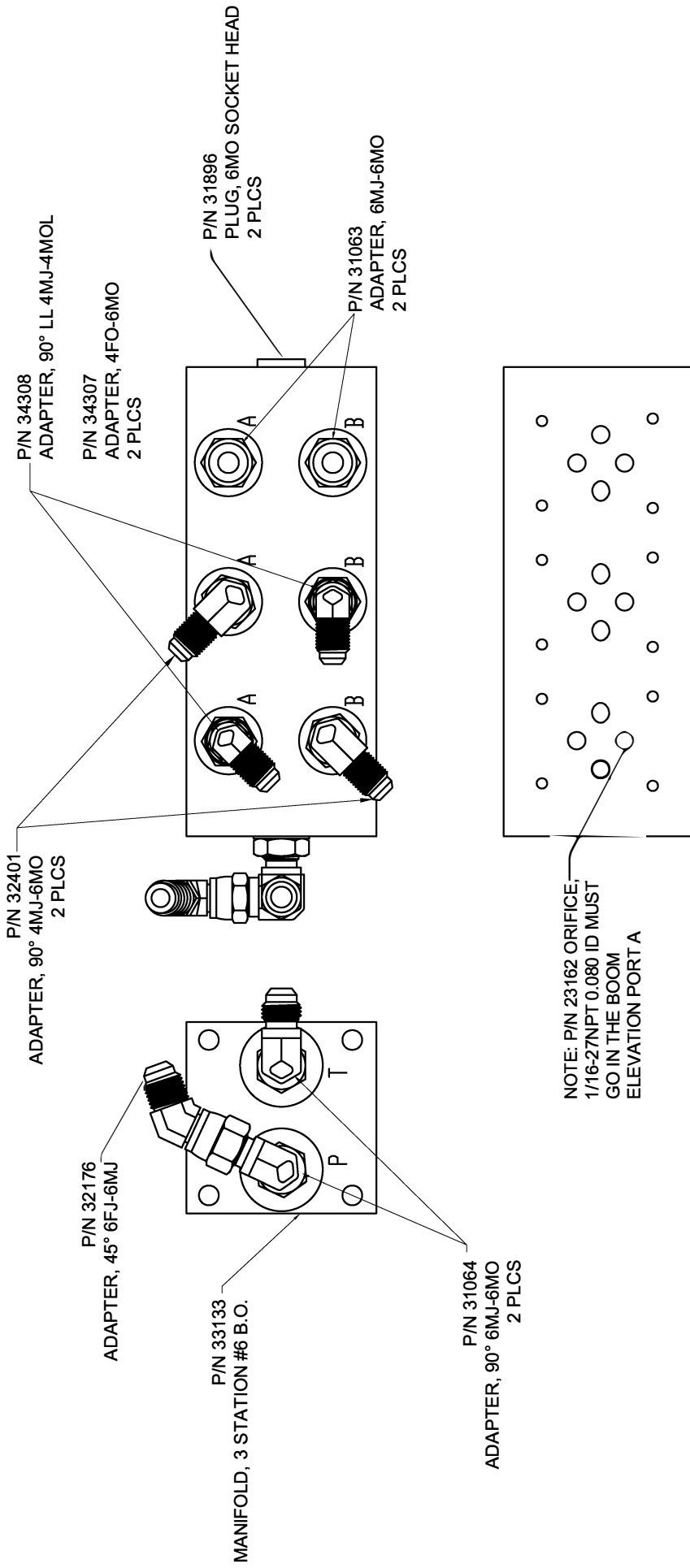

NOTE: p/n's 31063 & 31896 to be Wrench Tight;
 All Others are to be Hand Tight ONLY!

DRAWING NO.
16977-E

MANIFOLD ASSY 4000X #6/#6 BO

DRWN BY: KSP
 DATE: 07/16/09

Houston TX
 (713)-688-5533
 www.liftmoore.com



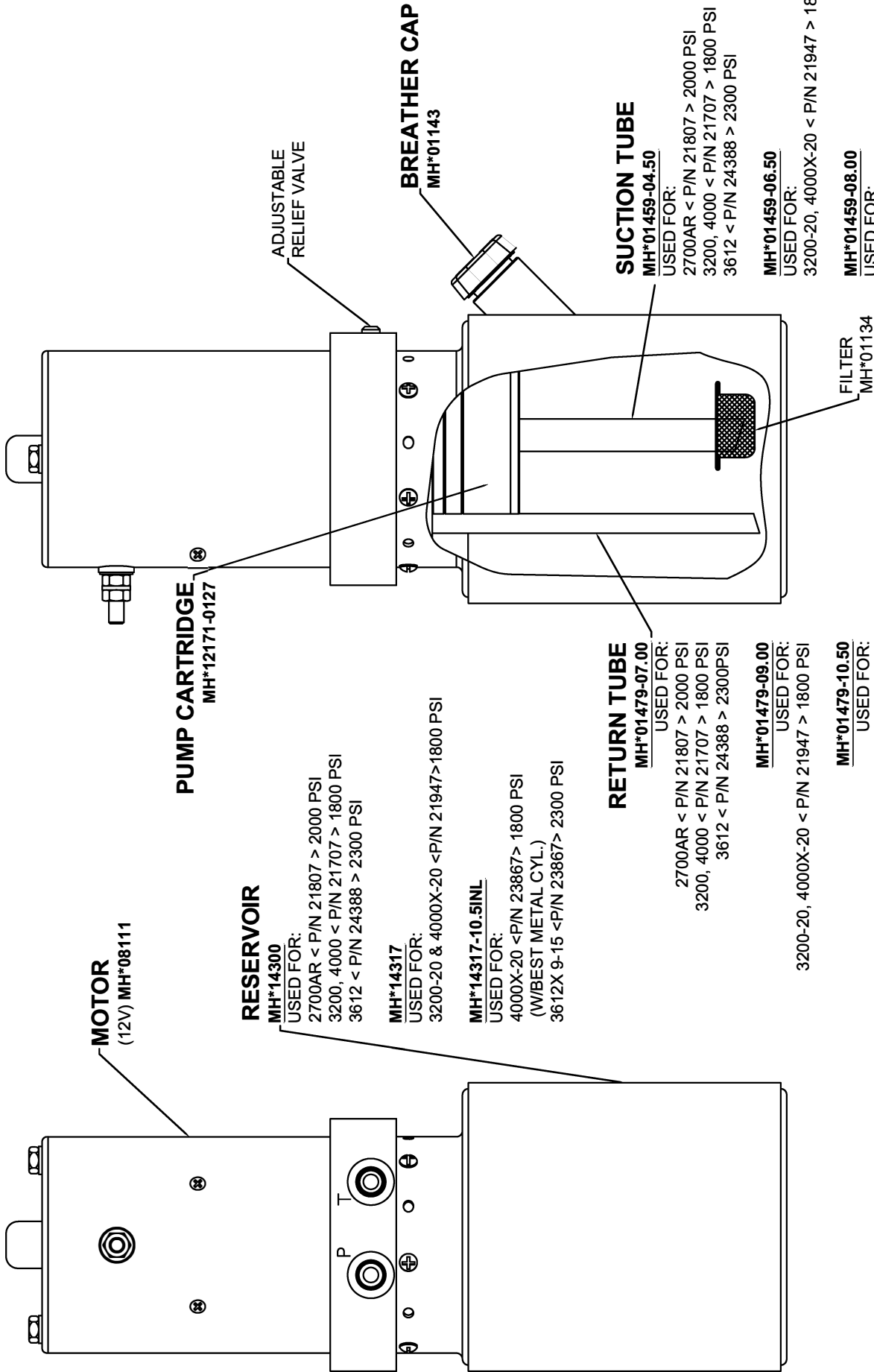

MOTOR
(12V) MH*08111

PUMP CARTRIDGE
MH*12171-0127

RESERVOIR

MH*14300

USED FOR:

2700AR < P/N 21807 > 2000 PSI
3200, 4000 < P/N 21707 > 1800 PSI
3612 < P/N 24388 > 2300 PSI

MH*14317

USED FOR:

3200-20 & 4000X-20 < P/N 21947 > 1800 PSI

MH*14317-10.5INL

USED FOR:

4000X-20 < P/N 23867 > 1800 PSI
(W/BEST METAL CYL.)
3612X 9-15 < P/N 23867 > 2300 PSI

RETURN TUBE

MH*01479-07.00

USED FOR:

2700AR < P/N 21807 > 2000 PSI
3200, 4000 < P/N 21707 > 1800 PSI
3612 < P/N 24388 > 2300PSI

MH*01479-09.00

USED FOR:

3200-20, 4000X-20 < P/N 21947 > 1800 PSI

MH*01479-10.50

USED FOR:

4000X-20 < P/N 23867 > 1800PSI
(W/BEST METAL CYL.)
3612X 9-15 < 23867 > 2300 PSI

ADJUSTABLE
RELIEF VALVE

BREATHER CAP
MH*01143

SUCTION TUBE

MH*01459-04.50

USED FOR:

2700AR < P/N 21807 > 2000 PSI
3200, 4000 < P/N 21707 > 1800 PSI
3612 < P/N 24388 > 2300 PSI

MH*01459-06.50

USED FOR:

3200-20, 4000X-20 < P/N 21947 > 1800 PSI

MH*01459-08.00

USED FOR:

4000X-20 < P/N 23867 > 1800 PSI
(W/BEST METAL CYL.)
3612X 9-15 < 23867 > 2300 PSI

FILTER
MH*01134

Houston TX
(713)-688-5533
www.liftmoore.com

DRWN BY: JC
DATE: 1/31/08

PUMP ASSY 2700,3200,4000,3612
MONARCH

DRAWING NO.

50624-E

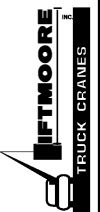



BY: JC
DATE: 2/11/08

ROTATION COMPONENTS & ADJUSTMENTS
4000 MODEL CRANES

DOCUMENT NO.

50540-C

TO ADJUST BACKLASH BETWEEN GEARS:

LOOSEN MOUNTING BOLTS

MAKE SMALL ADJUSTMENTS TO THE BACKLASH ADJUSTMENT SCREWS, NO MORE THAN A 1/4 TURN. ALTERNATE BETWEEN SCREWS SO THAT ALIGNMENT IS MAINTAINED.

SOME PLAY **MUST** BE LEFT BETWEEN THE GEARS OR THE CRANE WILL NOT OPERATE PROPERLY AND EXCESSIVE WEAR AND/OR DAMAGE WILL OCCUR. INITIAL SETTING IS SUCH THAT THE RETRACTED BOOM TIP MOTION IS LESS THAN 1 INCH.

WHEN FINISHED, TORQUE THE MOUNTING BOLTS TO 40 FT-LBS

TO ADJUST PLAY IN WORM MOUNTING:

TIGHTEN THE 3 SET SCREWS IN THE BEARING HOLDER THEN BACK THEM OUT 1 TURN

SCREW THEM BACK IN JUST UNTIL THEY ARE SNUG. OVER TIGHTENING WILL PUT THE WORM AND MOTOR IN A BIND AND IT WILL NOT FUNCTION PROPERLY.

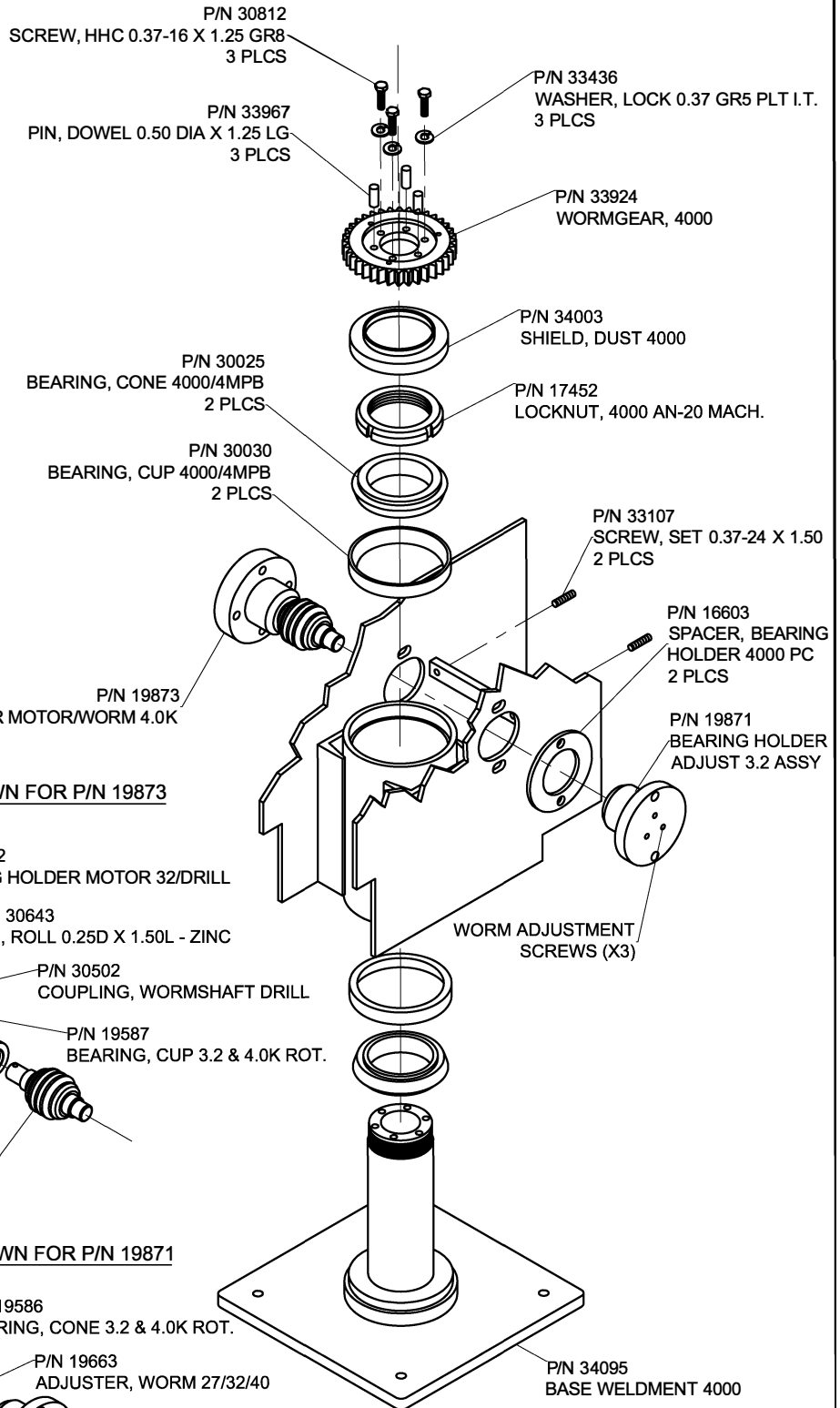

BREAK DOWN FOR P/N 19873

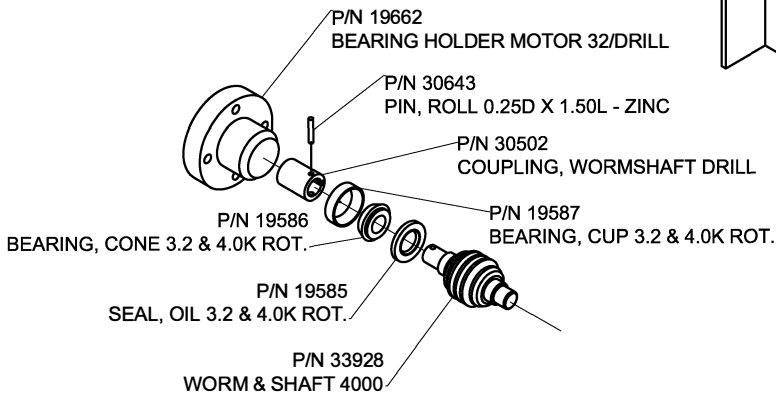

BREAK DOWN FOR P/N 19871

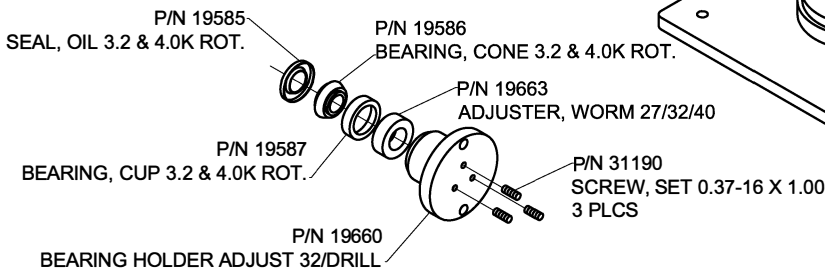



BY: JC
DATE: 7/07/08

ELECTRIC SWIVEL ASSY 4000X
4000X MODEL CRANES

DOCUMENT NO.

50547-D

DRAWING SHOWS PARTS BREAK DOWN OF ELECTRIC SWIVEL ASSEMBLY P/N 34137 & MOUNTING HARDWARE.

PART NUMBERS MARKED WITH " * " ARE NOT PART OF THE ASSEMBLY. IF ORDERING ENTIRE SWIVEL ASSEMBLY THESE PARTS MUST BE ORDERED SEPERATELY.

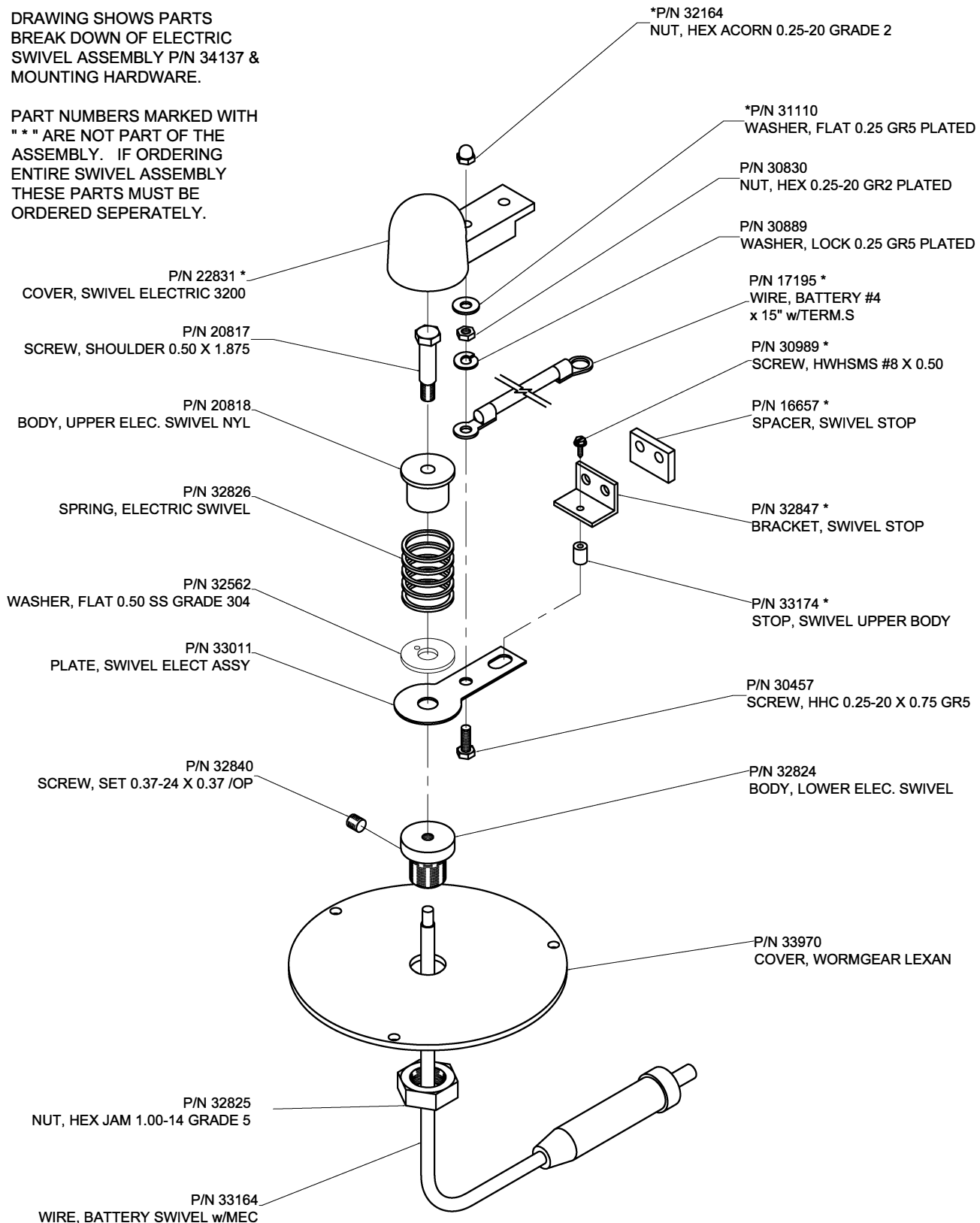

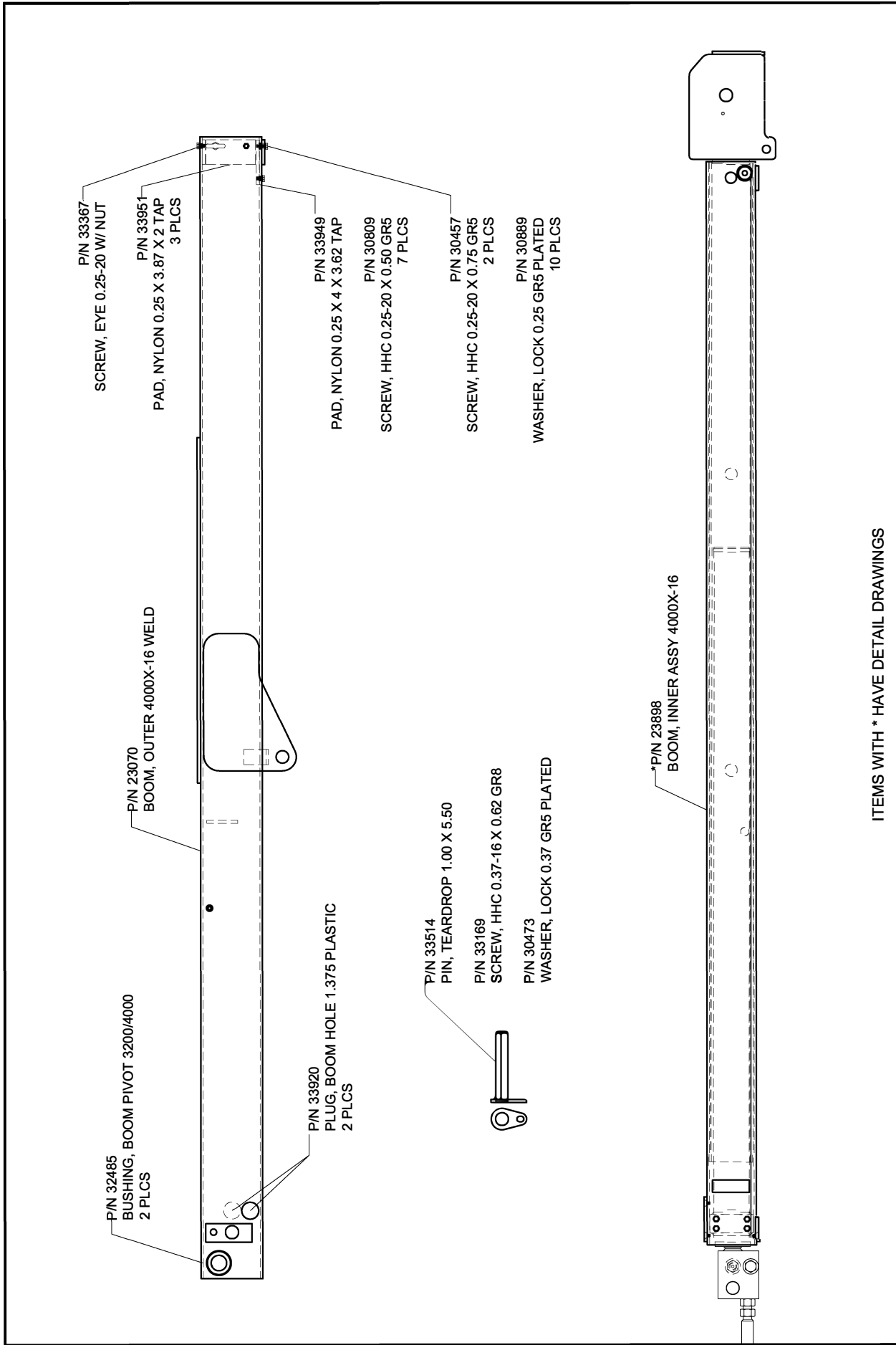

ITEMS WITH * HAVE DETAIL DRAWINGS

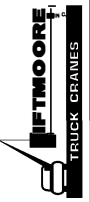

Houston TX
 (713)-688-5533
 www.liftmoore.com

DRWN BY: IS
 DATE: 7/26/10

BOOM ASSEMBLY 4000X-16
 L.S. ATB, E-STOP, 23872 WINCH

DRAWING NO.

23900-C

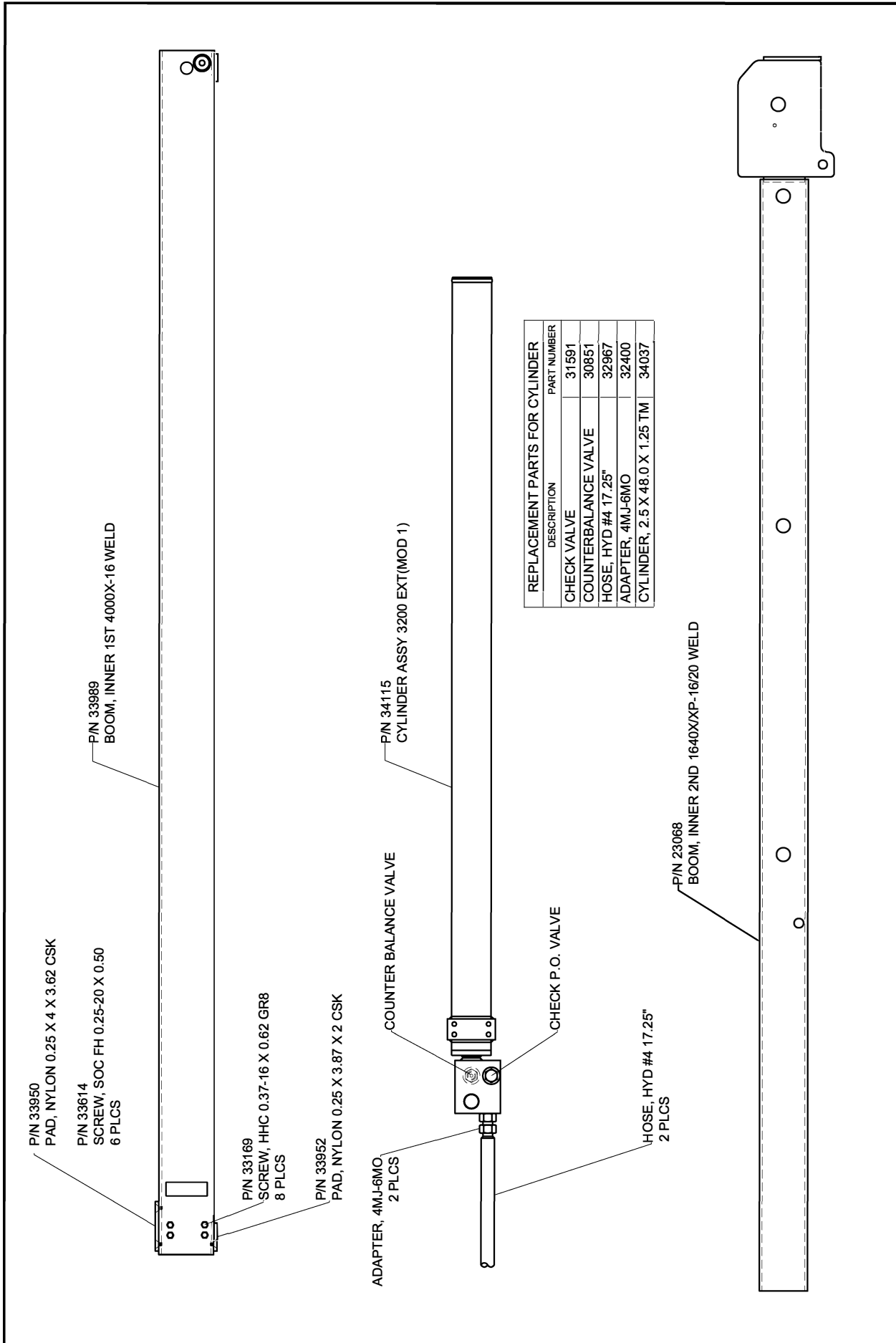



 Houston TX
 (713)-688-5533
 www.liftmoore.com

DRWN BY: IS
 DATE: 7/26/10

BOOM, INNER ASSY 4000X-16
 L.S. ATB, E-STOP, 23872 WINCH

DRAWING NO. **23898-A**

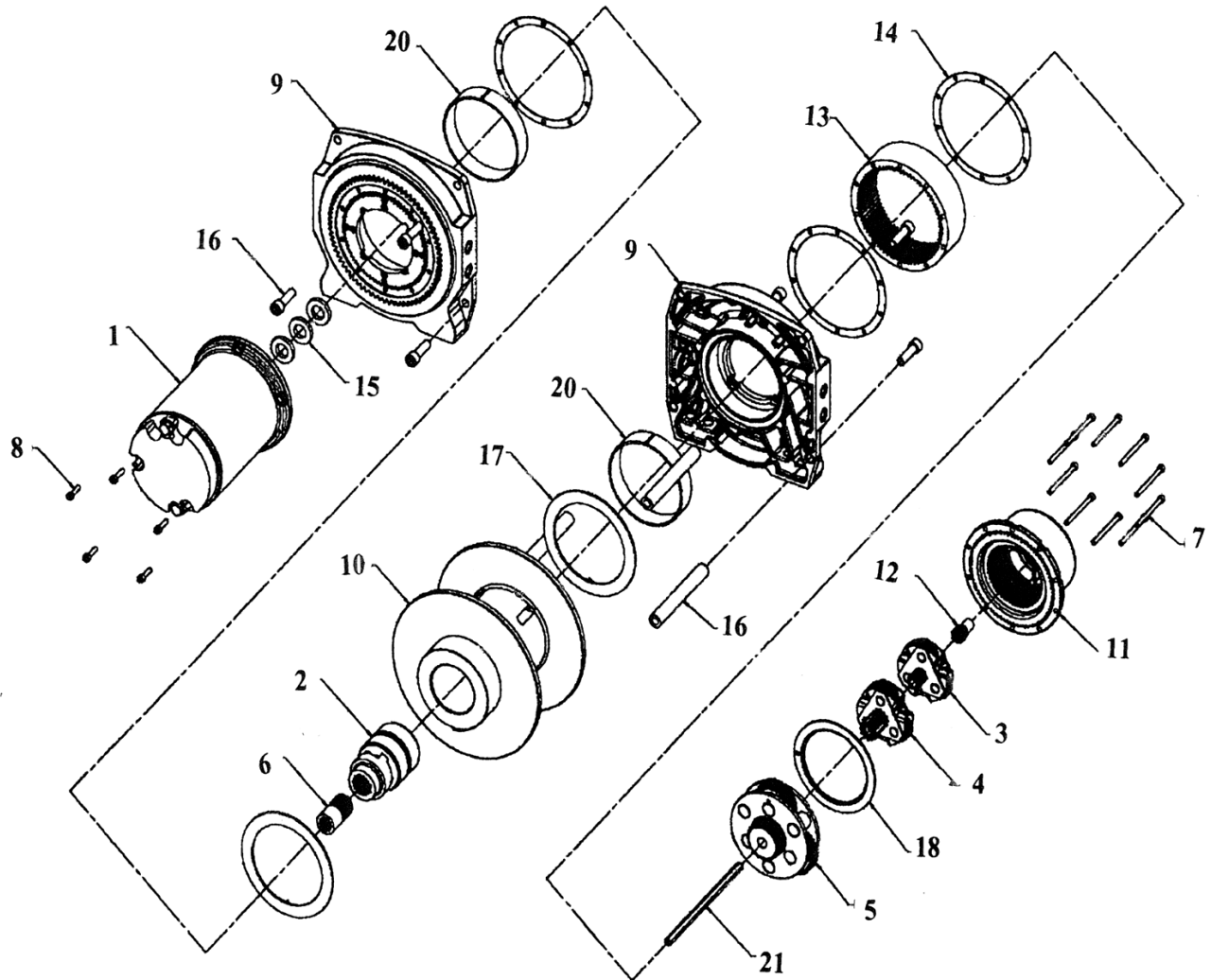
WINCH DC2000 12VDC P/N 23872



SERVICE PARTS LIST: DC2000LF HOIST-12V P/N 23872

ITEM REFERENCE		ITEM / KIT No.
1	MOTOR SPLINED 12V DC	WI*84211
2	BRAKE ASSEMBLY DC2000	WI*63550
3	CARRIER ASSY, STAGE 1	WI*28430
4	CARRIER ASSY, STAGE 2	WI*28433
5	CARRIER ASSY, STAGE 3	WI*28115
6	COUPLER, MOTOR/BRAKE	WI*32149
7	CPSCR, 10-24 X 2-1/4-HEX SOCKET HEAD-PI	WI*13850
8	CPSCR, SOC, 10-24 X 3/4, GR9 (KB)	WI*5553
9	(MTO) S/P DRUM SUPPORT, GEAR END	WI*85575
10	DRUM, (KB) 2000-MF, 4.25 DIA	WI*31618
11	SVC KIT END HOUSING SUBASSY, CLUTCH PLUG	WI*85583
12	GEAR, SUN, 12 TOOTH, STAGE 1	WI*13874
13	RING GEAR, ARG, 75 TOOTH	WI*25308
14	HOUSING, GASKET	WI*13848
15	SPACER, MOTOR	WI*15271
16	SVC KIT TIE ROD, ALUMN, .625 X 4.92	WI*85579
17	WASHER, TRUST, NYLATRON, CIM	WI*30277
18	WASHER, TRUST, NYLON, MIDRANGE	WI*13826
19	PARTS PACK, DC2000 HOIST	WI*60049
20	BUSHING DRUM NYLATRON	WI*30274
21	SHAFT-DRIVE-HEX 5/16 X 6.85	WI*84346

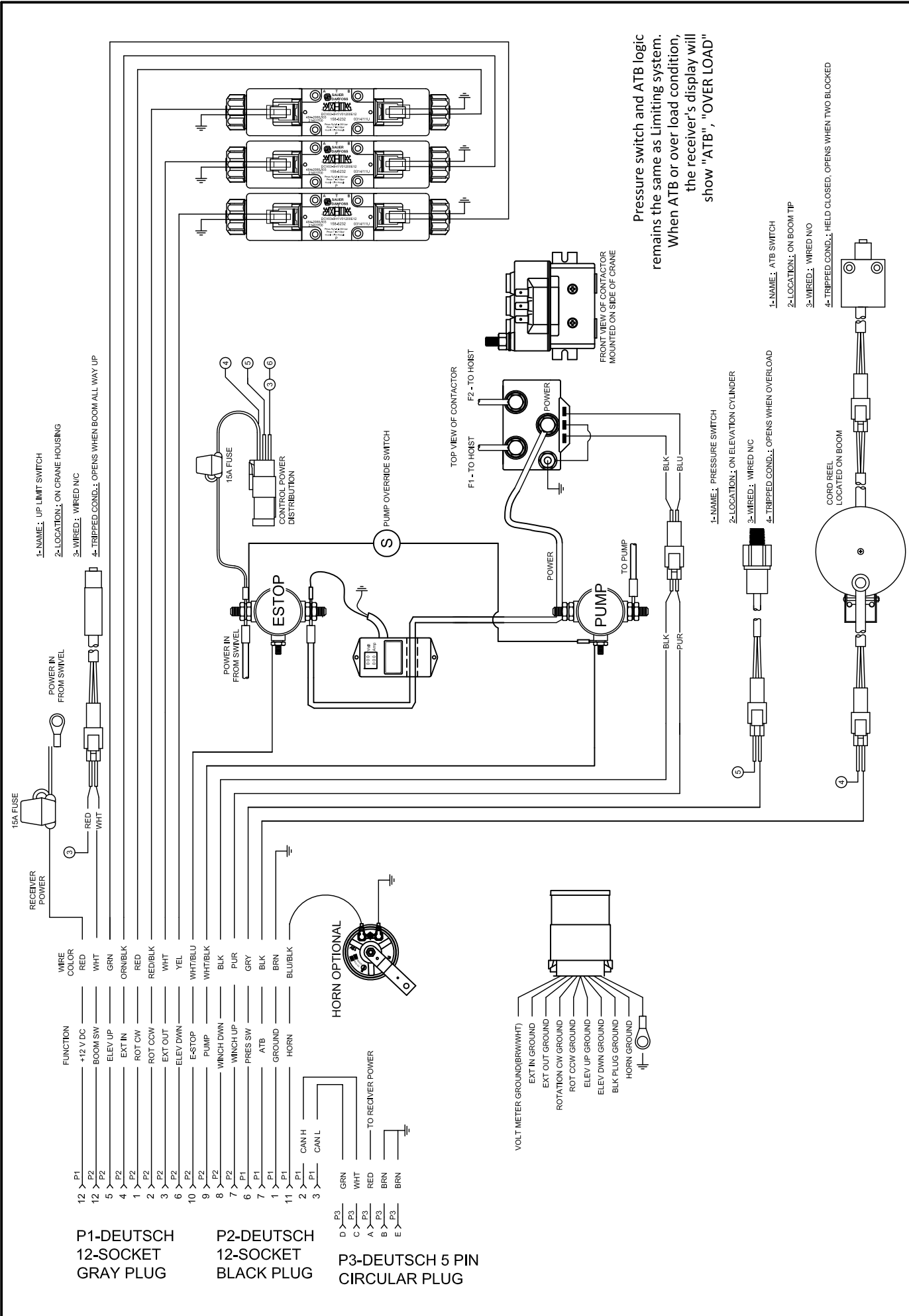

Pressure switch and ATB logic remains the same as Limiting system. When ATB or over load condition, the receiver's display will show "ATB", "OVER LOAD"

- 1-NAME: UP LIMIT SWITCH
- 2-LOCATION: ON CRANE HOUSING
- 3-WIRED: WIRED NIC
- 4-TRIPPED COND.: OPENS WHEN BOOM ALL WAY UP

- 1-NAME: PRESSURE SWITCH
- 2-LOCATION: ON ELEVATION CYLINDER
- 3-WIRED: WIRED NIC
- 4-TRIPPED COND.: OPENS WHEN OVERLOAD

- 1-NAME: ATB SWITCH
- 2-LOCATION: ON BOOM TIP
- 3-WIRED: WIRED NO
- 4-TRIPPED COND.: HELD CLOSED, OPENS WHEN TWO BLOCKED

FUNCTION	WIRE COLOR
+12 VDC	RED
BOOM SW	WHT
ELEV UP	GRN
EXT IN	ORN/BLK
ROT CW	RED
ROT CCW	RED/BLK
EXT OUT	WHT
ELEV DWN	YEL
E-STOP	WHT/BLU
PUMP	WHT/BLK
WINCH DWN	BLK
WINCH UP	PUR
PRES SW	GRY
ATB	BLK
GROUND	BRN
HORN	BLU/BLK

P1-DEUTSCH 12-SOCKET GRAY PLUG
 P2-DEUTSCH 12-SOCKET BLACK PLUG
 P3-DEUTSCH 5 PIN CIRCULAR PLUG

DRAWING NO. 50885-A

SCHEM, ELEC WIFI KTG
 3200/3612/4000, WIRELESS, PUMP OVERRRIDE

DRWN BY: JE
 DATE: 7/14/16

Houston TX
 (713)-688-5533
 www.liftmoore.com



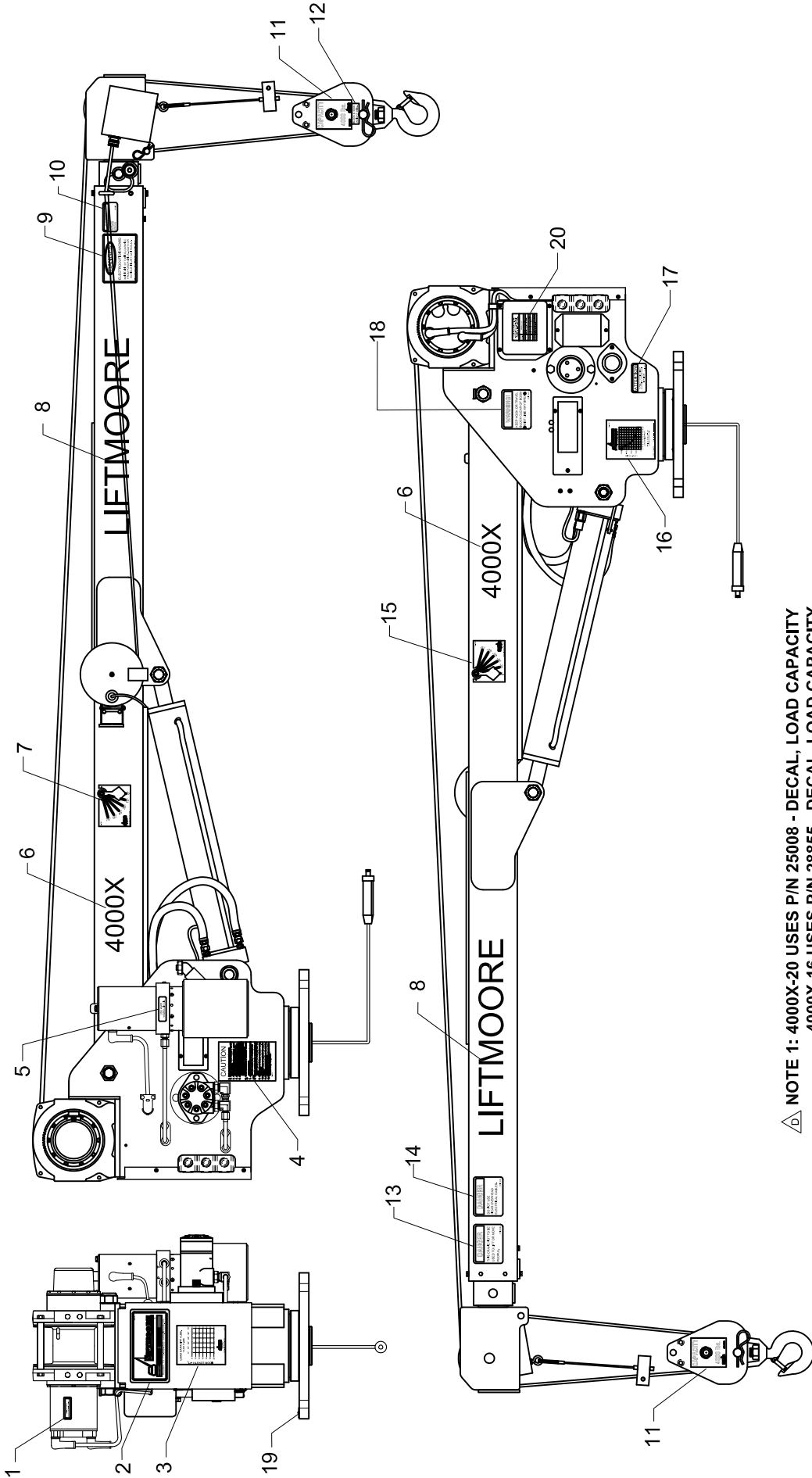

△ NOTE 1: 4000X-20 USES P/N 25008 - DECAL, LOAD CAPACITY
 4000X-16 USES P/N 28855 - DECAL, LOAD CAPACITY

#	PN	DESCRIPTION	QTY	#	PN	DESCRIPTION	QTY	#	PN	DESCRIPTION	QTY
1	32608	DECAL, MOTOR MAGNETS DAMAGE	1	8	33165	DECAL, LIFTMOORE - 2.50"	2	15	22375	DECAL, ANGLE PENDULUM LEFT	1
2	15581	DECAL, LOGO LARGE	1	9	15618	DECAL, DANGER ELECTRIC INJURY	1	16	21029	PLATE, SERIAL 1640X & 4000X-20	1
3	SEE NOTE 1		1	10	15612	DECAL, CAUTION PIN MUST BE IN	1	17	15577	DECAL, ATTENTION BATTERY	1
4	16102	DECAL, CAUTION READ MANUAL	1	11	34040	DECAL, TRAVEL BLOCK 4000 LBS.	2	18	15615	DECAL, WARNING TRAVELING BLOCK	1
5	16103	DECAL, USE 46AW HYD. OIL	1	12	22815	DECAL, BLOCK & HOOK WT. 30 lbs	1	19	23389	PLATE, SERIAL NO. MACH	1
6	20464	DECAL, 4000X HORIZONTAL	2	13	32085	DECAL, LIFTING PERSONNEL	1	20	27910	DECAL, ERROR CODES RELAY BOARD	1
7	22376	DECAL, ANGLE PENDULUM RIGHT	1	14	15579	DECAL, DANGER CABLES	1				



Houston TX
 (713)-688-5533
 www.liftmoore.com

DRWN BY: JC

DATE: 11/24/09

DECAL DIAGRAM FOR THE
 4000X DB LINE PM MOTOR

DRAWING NO.

58314-D

LIFTMOORE LIMITED WARRANTY

Parts and Structural

Liftmoore, Inc. warrants each LIFTMOORE crane to be free from defects in materials and workmanship for twelve (12) months from the date of delivery to the original customer. Under the terms of this warranty the crane structural components manufactured by LIFTMOORE, Inc. are warranted for thirty-six (36) months from the date of delivery to the original customer. LIFTMOORE, Inc. will repair or replace, as its sole discretion, any equipment or part that is returned f.o.b. to LIFTMOORE, Inc.'s plant at 7810 Pinemont Drive, Houston, Texas 77040, or to one of its authorized dealers, and is found by LIFTMOORE, Inc. or its authorized dealer to have been defective at the time of original delivery.

The foregoing warranty is the exclusive warranty made by LIFTMOORE, Inc. with respect to its cranes and is in lieu of all other warranties. ANY AND ALL OTHER WARRANTIES, EXPRESS OR IMPLIED, INCLUDING ANY WARRANTY OF MERCHANTABILITY OR FITNESS OF ANY CRANE FOR A PARTICULAR PURPOSE OR OPERATION, ARE HERBY EXPRESSLY DISCLAIMED.

The foregoing warranty applies only to LIFTMOORE cranes under normal use and service and does not apply in the event of damage caused by repair or alteration or damage during shipment, accident, negligence, overloading, or misuse, including operator's failure to follow any of the instructions issued with the crane.

This warranty is limited to the original purchaser and is not assignable. In order to submit a claim, the original purchaser must provide a copy of the original invoice for the crane in question within twelve (12) months following the delivery date and within 30 days from the date of repair.

The warranty applies only when the LIFTMOORE crane is used for commercial purposes and does not cover any purchase for use for personal, family or household purposes.

LIMITATION OF LIABILITY: LIFTMOORE, Inc.'s liability for any losses or damages resulting from any cause whatsoever, including LIFTMOORE, Inc.'s NEGLIGENCE or from a defective crane irrespective of whether such defects are discoverable or latent, shall in no event exceed the purchase price of the crane to which losses or damages are claimed, or at the election of LIFTMOORE, Inc., the repair or replacement of the defective crane.

In no event shall LIFTMOORE, Inc. be liable for any special, incidental, or consequential damages, including commercial losses or costs of any kind sustained by purchaser or any other person or for any damages for which purchaser may be liable to other persons by reason of any defect in any LIFTMOORE crane or any part thereof.

LIFTMOORE, Inc. reserves the right to make changes in design or construction of its cranes at any time without obligating itself to make such changes on cranes previously manufactured.

No agent, employee, or representative of LIFTMOORE, Inc. has authority to amend or modify the foregoing warranty or to bind LIFTMOORE, Inc. by any other warranty, guaranty, or assumption of liability.

In the event any provision of this warranty is for any reason held ineffective, the remaining provisions shall remain in full force and effect.

Some states do not allow limitations on how long an implied warranty lasts or the exclusion or limitation of incidental or consequential damages, so the above limitations and exclusions may not apply to you. This warranty gives you specific legal rights, and you may also have other legal rights that vary from state to state.

