

TABLE OF CONTENTS

USERS MANUAL P/N 26011

1032X

11 FT BOOM

L.S. ATB, E-STOP, XP TO X PCB BOARD, ROTATION ADJUSTER

SECTION I

GENERAL OPERATION, INSPECTION, AND MAINTENANCE

CRANE SAFETY RULES.....	F1122-B.....	1-1
INTRODUCTION	F1111-D.....	1-3
OPERATING RESTRICTIONS/PRACTICES	F1637-A	1-4
INSPECTION AND MAINTENANCE.....	F1113-D	1-7
MONTHLY INSPECTION REPORT	F1123-B.....	1-9
STANDARD HAND SIGNAL FOR CRANE OPERATION	F2409-0	1-10

SECTION II

CRANE SYSTEMS AND TROUBLESHOOTING

PENDANT CONTROL SYSTEM.....	F1753-0	2-1
SAFETY SYSTEM.....	F1115-F	2-2
HYDRAULIC SYSTEM	F1116-D	2-3
BASIC TROUBLESHOOTING	F1117-G	2-5
CONTROL TROUBLESHOOTING CHART	F1823-0	2-6
TROUBLESHOOTING SAFETY SYSTEM	F1127-C.....	2-7
DEUTSCH CONNECT & PINS	F2435-0	2-10

SECTION III

CRANE SPECIFICATIONS

LIFTING CAPACITIES	F1642-0	3-1
POWER FUNCTIONS AND SPEEDS.....	F1642-0	3-1
BOLT AND LUBRICATION SPECS	F1642-0	3-2
LUBE POINTS	F1642-0	3-3

SECTION IV

PARTS

BOX PARTS LIST	F2128-A	4-1
CRANE ASSEMBLY	DWG.26012-D	4-2
PENDANT CONTROL	DWG.25329-0	4-3
RELAY BOARD.....	DWG.24729-B.....	4-4
TRAVEL BLOCK ASSEMBLY	DWG.22556-C.....	4-5
ANTI-TWO BLOCK ASSEMBLY.....	DWG.22908-B.....	4-6
BOOM-BODY ASSEMBLY.....	DWG.26010-B.....	4-7
ELEVATION CYLINDER ASSEMBLY	DWG.21603-A	4-8
BODY ASSEMBLY	DWG.25994-D	4-9
MANIFOLD ASSEMBLY	DWG.25203-D	4-10
MANIFOLD ASSEMBLY PART II.....	DWG.24822-A	4-11
BASE-HOUSING ASSEMBLY.....	DWG.25993-0	4-12
ROTATION COMPONENTS	DWG.50570-B.....	4-13



F2127-F
7/7/15

HOUSTON, TEXAS
FAX: (800) 824-5559 (USA & Canada)
FAX: (713) 688-6324
PHONE: (713) 688-5533
www.liftmoore.com

TABLE OF CONTENTS

USERS MANUAL P/N 26011

1032X

11 FT BOOM

L.S. ATB, E-STOP, XP TO X PCB BOARD, ROTATION ADJUSTER

BOOM ASSEMBLY – 11 FT.....	DWG.27375-0	4-14
BOOM INNER ASSEMBLY – 11 FT.....	DWG.23838-0	4-15
WINCH.....	DWG.25048-A	4-16
ELECTRICAL WIRING HARNESS DTCH.....	DWG.25088-E.....	4-17
ELECTRICAL SCHEMATIC DTCH.....	DWG.50824-A	4-18
HYDRAULIC SCHEMATIC	DWG.50813-A	4-19
DECAL DIAGRAM	DWG.58372-A	4-20

WARRANTY	F1442-A
----------------	---------



F2127-F
7/7/15

HOUSTON, TEXAS
FAX: (800) 824-5559 (USA & Canada)
FAX: (713) 688-6324
PHONE: (713) 688-5533
www.liftmoore.com

CRANE SAFETY RULES

CAUTION!

1. READ AND UNDERSTAND OPERATOR'S MANUAL.
2. INSPECT VEHICLE AND CRANE, INCLUDING ITS OPERATION BEFORE DAILY USE.
3. USE THIS EQUIPMENT ONLY ON SOLID LEVEL GROUND WITH OUTRIGGERS OR JACKSTANDS PROPERLY SET.
4. BEFORE OPERATING THE CRANE REFER TO MAXIMUM LOAD CHART ON CRANE FOR OPERATING LOAD LIMITS.
5. BE SURE LOAD BEING LIFTED IS WITHIN SAFE WINCH CAPACITY AS WELL AS SAFE CRANE CAPACITY. MULTI-PART LINE OPERATION IS REQUIRED WHEN SINGLE LINE LOAD CAPACITY OF WINCH IS EXCEEDED.
6. DO NOT OPERATE, WALK, OR STAND UNDER THE BOOM OR ANY SUSPENDED LOAD.
7. ALWAYS PAY OUT LOAD LINE BEFORE EXTENDING BOOM. WIRE ROPE DAMAGE AND / OR BREAKAGE MAY OCCUR.
8. BOOM MUST BE IN ITS REST BEFORE MOVING VEHICLE.
9. BOOM TIP MUST BE DIRECTLY OVER THE LOAD BEFORE ANY LIFTING IS STARTED. DO NOT DRAG LOADS WITH THIS CRANE.
10. MAINTAIN THIS CRANE AS REQUIRED IN THE OWNER'S MANUAL.
11. DO NOT ALLOW PERSONNEL TO RIDE ON THE LOAD LINE, LOAD, OR BOOM OF THIS CRANE.
12. IT IS UNLAWFUL TO OPERATE THIS EQUIPMENT WITHIN TEN FEET OF HIGH VOLTAGE LINE



THIS PAGE INTENTIONALLY LEFT BLANK



HOUSTON, TEXAS
FAX: (800) 824-5559 (USA & Canada)
FAX: (713) 688-6324
PHONE: (713) 688-5533
www.liftmoore.com

INTRODUCTION

This crane is a powerful machine designed to lift and move heavy loads. There are many hazards associated with these operations. Liftmoore has designed this crane to be as safe as possible but -

IT IS THE OPERATOR'S RESPONSIBILITY TO PREVENT ACCIDENTS!

This takes pre-planning, attention, and knowledge of basic principles and rules. Even if you have used similar cranes, reading this manual in its entirety will help prevent damage, injury, or even loss of life; benefits well worth the short amount of time it takes to read these pages.

REGULATORY AUTHORITY

Use of this crane is governed by OSHA 29 CFR 1910.180 and may be governed by other federal, state, or local regulations.

IT IS THE OPERATOR'S RESPONSIBILITY TO UNDERSTAND AND COMPLY WITH ALL APPLICABLE REGULATIONS GOVERNING THE OPERATION, INSPECTION, AND MAINTENANCE OF THIS CRANE.

Personnel should be trained, tested, and certified, as recommended by OSHA and ANSI standards, before operating this crane.

USING THIS MANUAL

This manual assumes that the crane is mounted on a typical service body type or similar truck, which is powered by the vehicle electrical or hydraulic system, and is controlled by either the standard pendant control or FM radio control sold by Liftmoore, Inc.

This manual is supplied to provide basic guidelines for the safe use, routine maintenance, and general inspections of this crane.

This manual is supplied to provide basic guidelines for the safe use, routine maintenance, and general inspections of this crane.

Laws, regulations, standards, or policies may be more restrictive than this manual. If a conflict exists for any limit or condition, the safest or most prohibitive shall be used. Under no circumstances shall the load, moment, or stability ratings be exceeded.

Pay particular attention to the following:

WARNING! – Draws attention to hazards, conditions, or procedures that if not observed could result in injury or death.

CAUTION! – Draws attention to hazards, conditions, or procedures that if not observed could result in damage to the crane, load, or other equipment. Equipment failure could in turn lead to injury or death.

NOTE! – Draws attention to conditions or procedures that are essential to emphasize.

For questions, interpretations, or to report errors, please contact Liftmoore, Inc, Engineering Dept.



OPERATING PRACTICES

OPERATING RESTRICTIONS

DUTY CYCLE

For Electric Cranes the duty cycle time should be limited to 10%. This is limited by heat buildup in the motors and declining charge in the batteries. (Installing extra batteries near the crane helps keep the voltage at maximum.)

PERSONNEL

LIFTING OR MOVING OF PERSONNEL IS STRICTLY PROHIBITED! This crane was neither designed nor intended to lift personnel. Under no circumstances should anyone be allowed to ride on the crane, line, or load. All non-essential personnel must be kept away when using the crane. The load must never be moved over people, nor must anyone be allowed to pass or stand under a suspended load.

ELECTRICAL LINES

Consult ANSI B30.5 for operating procedures, minimum safe distances, and prohibited zones when working around electrical lines or poles.

When operating near electrical power lines, the crane must be positioned so that the distance from the crane to the lines or poles is equal to or greater than the length of the fully extended boom plus the minimum safe distance required.

All parts of the crane, line, and load must be kept a minimum safe distance from electrical power lines and poles. This distance is 10 feet for electrical lines carrying 50kV or less.

UNDER NO CIRCUMSTANCES SHOULD A CRANE BE OPERATED UNDER ELECTRICAL POWER LINES.

SETUP

POSITION The vehicle must be positioned so that the load is kept as close to the crane base as possible to reduce the moment on the crane. Consideration must be given to starting and ending position as well as firmness and slope of the ground and any obstructions.

OUTRIGGERS The outriggers or jackstands must be firmly set and the vehicle as level as possible. This will reduce the stresses on the rotation drive and keep the load off the vehicle's suspension. Keep in mind that the weight on the vehicle will shift as the crane and load is rotated.

MANUAL BOOM EXTENSION If the manual extension part of the boom is needed, it must be extended and the boom pin placed in the required position. Insert the pin and replace the pin's hairpin keeper before attempting to lift any load.

LOAD LIMIT The operator must understand the crane load chart. The operator must ensure that the load is within the load limits over the entire range which it will be moved. Be sure to include the weight of any lifting devices including the travel block.

The load limit chart is attached to the side of the crane to aid the operator.

The boom angle indicator and chart aids the operator in determining the load capacity at various boom angles and extensions. It also gives the load limit at that configuration.

STABILITY A stability chart must be posted near the crane. The operator must understand the stability chart. The crane may be de-rated over some areas of its operating radius.



TRAVEL BLOCK The operator must determine if the load is within the single line compatibility of the winch or if a multi-part line configuration is needed.

REEVING Ensure the proper routing of the rope through the sheaves and travel block. The rope must lie in the sheave groove and must not rub against any metal objects.

Ensure the rope is correctly wound on the winch drum. The crane assembly drawing will indicate if the rope must be wound over the top or bottom of the drum. The rope must never contact any part of the winch mounting.

WARNING!

If the winch winding direction is reversed the brake will not work and the load will fall.

ATTACHING THE LOAD

POSITION The boom tip must be moved over the load before lifting so that it will be lifted straight up.

CAUTION!

Never drag a load with the crane. Dragging a load puts very high stresses on the crane for which it was not designed.

ROPE Check the rope condition to ensure it is not frayed or damaged. Ensure that the rope is not kinked and that it does not contact any sharp edges or make any sharp bends.

If using double line configuration, ensure that the lines are not twisted.

CAUTION!

Never wrap the hoist rope around the load! Serious damage to the rope WILL occur.

HOOK Always make sure the load is applied to the throat of the hook. Never use a bent hook.

CAUTION!

Always lift with the throat of the hook. Never lift with the load applied to the tip of the hook. Doing so will bend the hook.

SLINGS If the load does not have a lifting eye, use a nylon, chain, or other type of sling designed for lifting and rated for loads greater than that being lifted.

BALANCE Ensure the load will be secure and balanced when lifted. Ensure that the load cannot shift in the sling and that the sling cannot slide across the hook should the load become unbalanced.

LIFTING THE LOAD

Before lifting, ensure that the load is free from all mountings and is no way attached or stuck to anything.

Ensure that at least five full wraps remain on the winch drum at all times.

Test the winch brake by lifting the load a few inches and ensuring that it does not slip.



HOLDING THE LOAD

The operator must keep the load in sight at all times once it is lifted.

The operator must never leave the controls once the load is lifted.

The operator must ensure that no one is allowed to pass or stand under a suspended load.

CAUTION!

Never move the vehicle with a suspended load. Doing so will put dynamic loads on the crane for which it was not designed.

MOVING THE LOAD

Before moving the load, make sure the path is free of any obstructions or people.

Avoid sudden accelerations or stops. Speeds must be kept to a minimum, especially rotation, to keep the load from swinging.

Avoid sudden reversing of direction. Do not reverse direction while the load is still moving.

Make sure that no part of the crane, boom, or load makes contact with any obstruction or comes within a minimum of ten feet from any electrical line.

TRANSIT

While in transit, the crane must be stowed, preferably in a boom rest. The crane must be prevented from rotating and the hook prevented from swinging.



INSPECTION AND MAINTENANCE

OSHA and ANSI require frequent and periodic inspections. Records of these inspections must be kept readily available. Liftmoore requires periodic maintenance to ensure proper operation and prolonged life of the crane.

INSPECTION

DAILY INSPECTION

OSHA 29CFR 1910.180 (d)(2)(i) requires the following be checked daily prior to use:

- All control mechanisms for maladjustment interfering with proper operation as well as for excessive wear of components and contamination by lubricants or other foreign matter.
- All safety devices for malfunction. This should include the anti-two block and pressure switch.
- Deterioration or leakage in air or hydraulic systems.
- Crane hooks with deformations or cracks. For hooks with cracks or having more than 15 percent in excess of normal throat opening or more than 10 deg. twist from the plane of the unbent hook.
- Electrical apparatus for malfunctioning, signs of excessive deterioration, dirt, and moisture accumulation. This should include the battery terminals, master disconnect switch, electrical swivel
- The wire rope shall be replaced if any of the following conditions are noted:
 - Kinking, crushing, bird-caging, or other damage
 - Reductions from nominal diameter of more than one-sixty-fourth inch for diameters up to and including five-sixteenths inch, one-thirty-second inch for diameters three-eighths inch to and including one-half inch.
 - Thimble is not in place or is damaged
 - Any evidence of heat damage
 - Six or more randomly distributed broken wires in 1 lay
 - Three or more broken wires in 1 strand in 1 lay

MONTHLY INSPECTION

A thorough inspection of all ropes in use shall be made at least once a month and a certification record which includes the date of inspection, the signature of the person who performed the inspection and an identifier for the ropes shall be prepared and kept on file where readily available. All inspections shall be performed by an appointed or authorized person. Any deterioration, resulting in appreciable loss of original strength shall be carefully observed and determination made as to whether further use of the rope would constitute a safety hazard. Some of the conditions that could result in an appreciable loss of strength are the following:

- Reduction of rope diameter below nominal diameter due to loss of core support, internal or external corrosion, or wear of outside wires.
- A number of broken outside wires and the degree of distribution of concentration of such broken wires.



- Worn outside wires.
- Corroded or broken wires at end connections.
- Corroded, cracked, bent, worn, or improperly applied end connections.
- Severe kinking, crushing, cutting, or unstranding.

PERIODIC INSPECTION

An Annual Inspection Form is included in this manual. OSHA 29CFR 1910.180 (d)(2)ii) requires periodic inspections of this crane. Liftmoore recommends an annual inspection using the included form.

MAINTENANCE PRECAUTIONS

The crane should be maintained monthly for safety reasons and to reduce stress on the crane.

WARNING!

Never perform any maintenance while the crane has any type of load on it. Use the manual operation procedure to lower the load if necessary.

WARNING!

Hydraulic cylinders may have high pressure stored in them even after hydraulic power is removed.

The counterbalance and pilot operated check valve in the cylinder will always hold some pressure in the cylinder. Slightly extending the cylinder then retracting a small amount will relieve most of the pressure in the cylinder. **DO NOT DEADHEAD THE CYLINDER!** This will store the maximum amount of pressure in the cylinder. Care should be taken when either valve is removed from the cylinder as some pressure will still remain.

After any maintenance has been performed the crane shall not be operated until all guards have been reinstalled, all safety

devices reactivated, and maintenance equipment removed.

LUBRICATION Refer to the crane specification section for the periodic maintenance schedule and type of lubrication required.

BOLTS Bolts may loosen over time due to vibration; therefore they should be checked periodically. If bolts need to be replaced, make sure they are replaced with bolts of equal or greater strength. Check the periodic maintenance schedule (Crane Specification Section) for bolt specification and torque.

NOTE!

Sheave and boom and cylinder pivot bolts are not standard bolts. The shank and thread length of these bolts have been modified so that they do not pivot on the threads. Consult the parts section of this manual for part numbers of these bolts.

OTHER MAINTENANCE

Refer to parts drawings for any specific maintenance or adjustment procedures such as hydraulic winch brake, rotation drive gear set adjustment, Ect.



MONTHLY INSPECTION REPORT

Crane Model No. _____ **Serial Number** _____

- Are Boom Hitch Pins and Keepers in place? Yes _____ No _____
- Wire Line Hook with Safety Latch Working? Yes _____ No _____
- Is Hook OK, (Not bent)? Yes _____ No _____
- Is Thimble on Wire Rope OK? Yes _____ No _____
- Is Traveling Block in use? Yes _____ No _____
- Is Wire Rope OK, not kinked or frayed? Yes _____ No _____
- Are all Boom Sections straight? Yes _____ No _____
- Are Sheave Bolts in place and tight? Yes _____ No _____
- Do all Sheaves rotate easily? Yes _____ No _____
- Are Mounting Bolts tight? Yes _____ No _____
- Is Anti Two-Block functioning properly? Yes _____ No _____
- Is Boom Angle Indicator in place and functioning and is Chart legible? Yes _____ No _____
- Are Cylinder Mounting Bolts secure? Yes _____ No _____
- Are Winch Mounting Bolts tight? Yes _____ No _____
- When stopped does winch drift less than 1.0 Inches? Yes _____ No _____
- Is Load Chart in place and easily read? Yes _____ No _____
- Are functions on Pendant operating correctly? Yes _____ No _____
- Is Hydraulic Reservoir full? Yes _____ No _____
- Is Outrigger straight and functioning? Yes _____ No _____
- Any items checked 'No' must be repaired before using this crane.

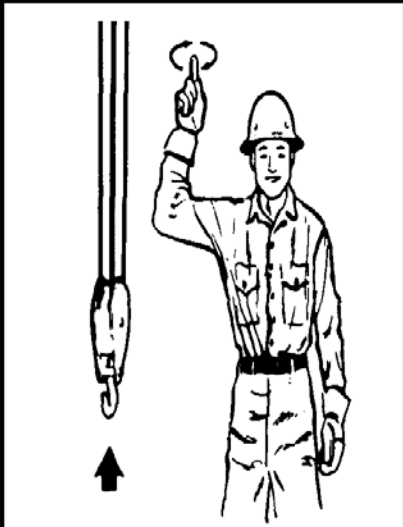
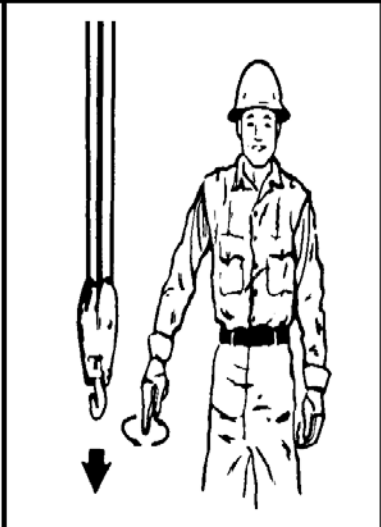
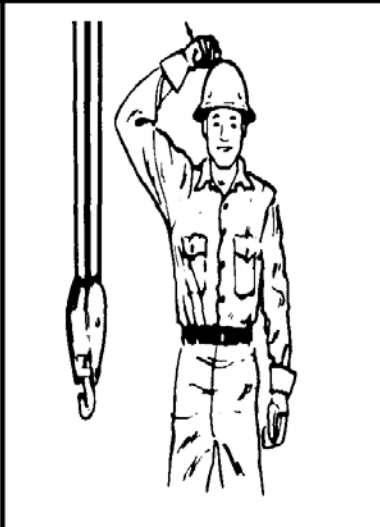
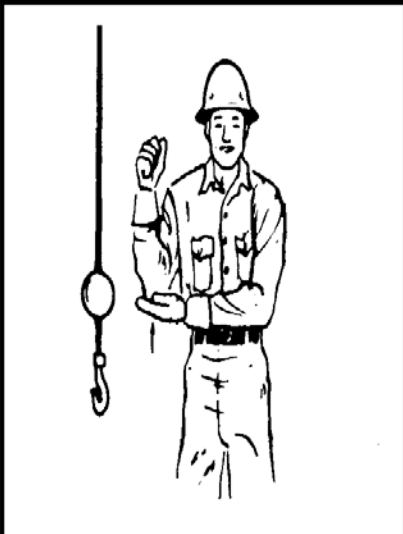
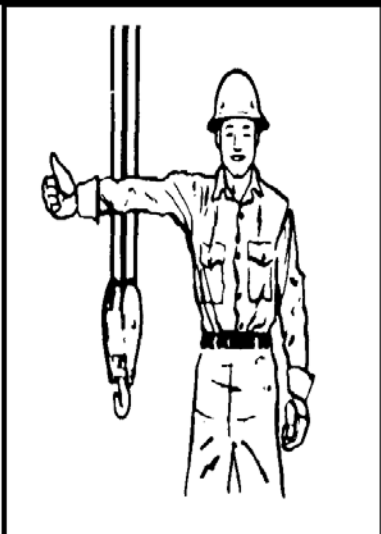
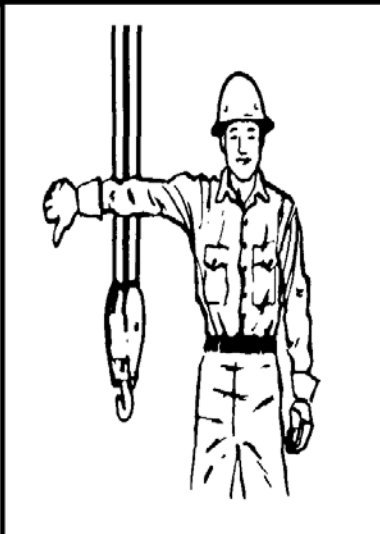

STANDARD HAND SIGNALS FOR CONTROLLING CRANE OPERATIONS

 <p>HOIST. With forearm vertical, forefinger pointing up, move hand in small horizontal circle.</p>	 <p>LOWER. With arm extended downward, forefinger pointing down, move hand in small horizontal circle.</p>	 <p>USE MAIN HOIST. Tap fist on head; then use regular signals.</p>
 <p>USE WHIPLINE (Auxiliary Hoist). Tap elbow with one hand; then use regular signals.</p>	 <p>RAISE BOOM. Arm extended, fingers closed, thumb pointing upward.</p>	 <p>LOWER BOOM. Arm extended, fingers closed, thumb pointing downward.</p>

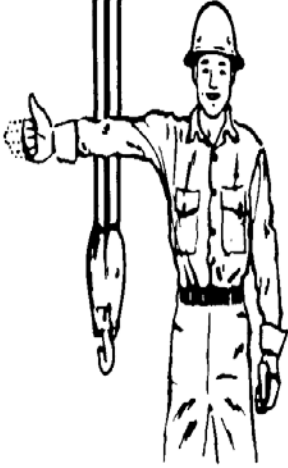
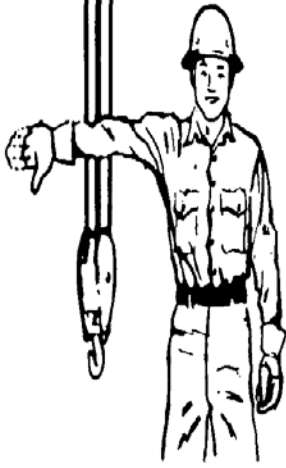
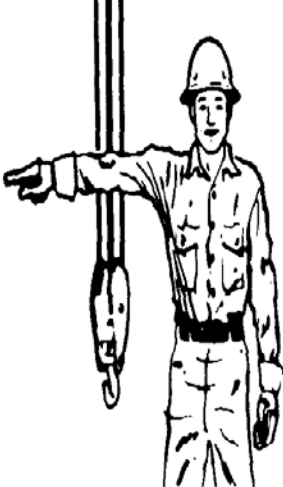
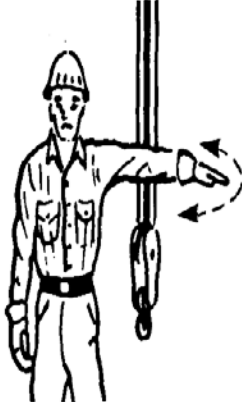
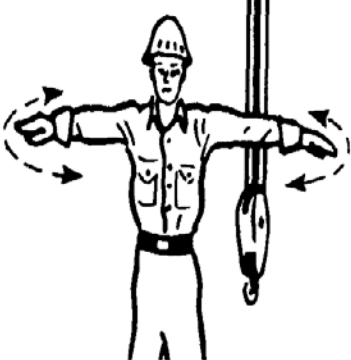
 <p data-bbox="258 749 594 926">MOVE SLOWLY. Use one hand to give any motion signal and place other hand motionless in front of hand giving the motion signal. (Hoist slowly shown as example.)</p>	 <p data-bbox="630 749 963 894">RAISE THE BOOM AND LOWER THE LOAD. With arm extended, thumb pointing up, flex fingers in and out as long as load movement is desired.</p>	 <p data-bbox="1003 749 1336 926">LOWER THE BOOM AND RAISE THE LOAD. With arm extended, thumb pointing down, flex fingers in and out as long as load movement is desired.</p>
 <p data-bbox="267 1493 597 1564">SWING. Arm extended, point with finger in direction of swing of boom.</p>	 <p data-bbox="638 1493 954 1598">STOP. Arm extended, palm down, move arm back and forth horizontally.</p>	 <p data-bbox="995 1493 1328 1598">EMERGENCY STOP. Both arms extended, palms down, move arms back and forth horizontally.</p>

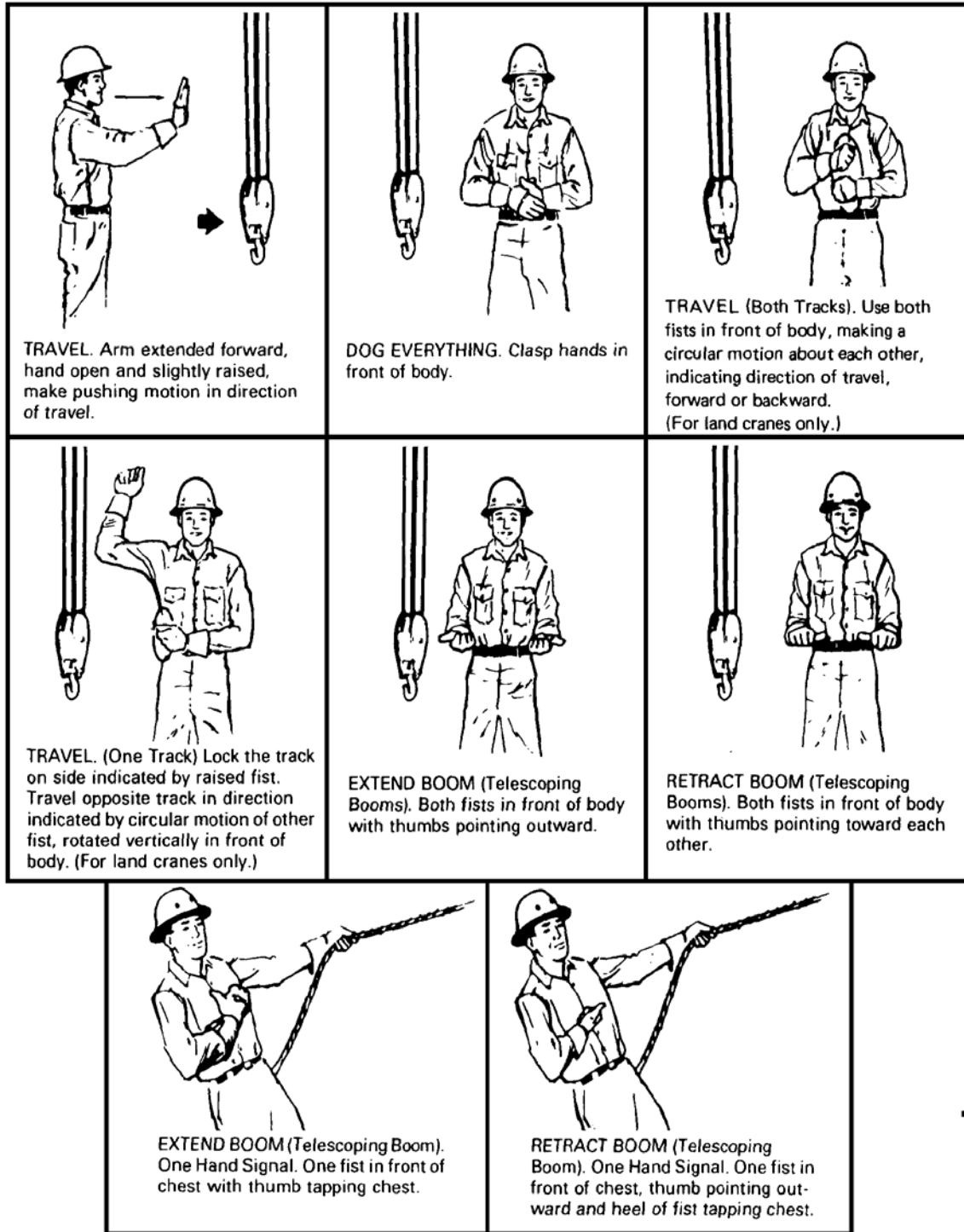

ON/OFF PENDANT CONTROL SYSTEM

Liftmoore cranes are electrically controlled using the hand-held pendant, which works in conjunction with the crane control module to operate powered functions.

PENDANT

All user inputs are facilitated by the remote pendant control. The pendant consists of pistol grip housing, wire, and control plug. The control plug mates with the crane control socket.

CRANE CONTROL MODULE

For ON/OFF (non-proportional) cranes the crane control module contains only the limiting system control board. It is a single printed circuit board enclosed in a rugged, sealed housing. Status LEDs are located on the circuit board to aid in troubleshooting.

The limiting system control is part of the safety system. Refer to that section for more information.

E-STOP

This feature is located on the pendant control box. The E-Stop button controls a relay in the crane's electrical power supply line. When pressed, electrical power is disconnected. To restore power you must turn button clock-wise until it pops back up

OPERATION

Plug the pendant into the crane control socket. Ensure all pins are straight and free of dirt, moisture, and corrosion. Turn the locking ring approximately 1/3 turn until it clicks into the locked position.

Select the function switch and direction as indicated on the label for the desired operation.

CARE AND MAINTENANCE

The pendant control is designed to be as rugged and maintenance free as possible; however, care should be used in handling and storage as it is expensive to replace.

Follow these simple practices:

- Keep the pendant out of the weather
- When not in use, store the pendant inside the vehicle or body compartment
- Do not wrap the wire too tightly as internal damage to the wires may result
- Do not place sharp or heavy object on the cord

NOTE!

The pendant is designed to be weatherproof not waterproof. It may be used in inclement weather, but if left outside or where water can puddle, water can seep inside.

Maintenance should be limited to routine inspection of the plug, wire, and fasteners.



SAFETY SYSTEM

The safety system is designed to help prevent damage to the crane that would be caused by overload or two-blocking. The system consists of a load sensor, anti-two block device (optional on smaller, electric cranes), and limiting system control board.

When the applicable switch detects an overload or two-block condition, the limiting system will prevent activation of winch up, boom down, and extend out since these directions would cause damage. Winch down, boom up, extend in, and power rotation will still function so that the crane can be moved to a safe configuration.

CAUTION!

Never de-activate or override safety functions. Doing so can result in serious damage to the crane and possibly injury or death.

LOAD SENSOR

A pressure activated switch in the elevation cylinder acts as a load sensor. This switch is normally closed and opens at the preset pressure corresponding to the load rating of the crane.

CAUTION!

The load sensor will not function when the elevation cylinder is fully retracted and is inaccurate when the boom is below horizontal.

CAUTION!

The operator must never rely strictly on the load sensor to determine overload conditions. The load and load limits must always be known and adhered to.

ANTI-TWO BLOCK

The anti-two block device (optional on smaller electric cranes), mounted on the boom crown plate, consists of a normally open switch actuated by a lever. A weight is attached to the lever and holds the switch

closed. If the weight is lifted by the hook or travel block the switch opens.

The power and signal wires are wired through the cord reel, which is in turn wired to the ATB switch.

LIMITING SYSTEM CONTROL

The limiting system control prevents output of winch up, boom down and extend out if it is not receiving a signal from either the ATB or load sensor.

The ATB does not trip boom down when winch is mounted on the boom.

There is a one second delay before deactivation of boom down when the load sensor is tripped to prevent false readings caused by pressure spikes.

MISCELLANEOUS

UP LIMIT SWITCH

The up limit switch prevents the elevation cylinder from reaching full extension. If the elevation cylinder were to "dead-head", the resulting pressure would activate the load sensor, preventing boom down. The boom would then have to be lowered using the manual operation buttons on the solenoid valves.

CIRCUIT BREAKER, FUSE

For electric cranes a 150 Amp circuit breaker is supplied with the crane. It should be installed as close to the battery as possible. For hydraulic cranes a 10 Amp blade type fuse is supplied.

DISCONNECT SWITCH

A power disconnect switch is supplied with the crane. Power to the crane should be turned off whenever not in use. This is to prevent inadvertent or unauthorized use and will help prevent corrosion at electrical connections.



HYDRAULIC SYSTEM

Integrated Hyd Proportional

The hydraulic system consists of the hydraulic swivel, manifold with solenoid valves, cylinders, motors, and tubing and hoses. Hydraulic power is received from an external hydraulic source, typically a PTO driven pump attached to the vehicle transmission. The hydraulic system uses open center valves in series so that multiple functions can be operated simultaneously.

SWIVEL- (NOT USED IN 1032 OR 1640)

The hydraulic swivel is a two-port swivel that allows continuous, unlimited rotation. Refer to drawing (20498) for more information.

MANIFOLD

The hydraulic manifold consists of a differential pressure sensing flow control valve, the system relief valve, proportional flow control valve, and 4 way directional control valves.

The differential pressure sensing (DPS) valve is a pilot operated pressure compensated flow control cartridge valve located in cavity CT1. It supplies the required flow to the manifold and returns excess flow to the tank so that pressure drop and heat build up are minimized.

The system relief valve prevents damage that would be caused by excessive pressure in the system. It is a cartridge type valve located in cavity CT2. Factory setting is 2800PSI.

The proportional valve is an electrically operated flow control valve. It allows the operator to control the flow, and therefore the speed, of the selected functions. The flow output is directly proportional to the electrical input. The valve may be operated manually by depressing the manual operation button on the top of the valve.

Each hydraulically operated function is controlled by a 4 way, 3 position open center solenoid valve. It is electrically operated and spring biased to center. A manual operation button is incorporated in the coil retaining nut.

Each hydraulically operated function is controlled by a 4 way, 3 position open center solenoid valve. It is electrically operated and spring biased to center. A manual operation button is incorporated in the coil retaining nut.

CYLINDERS

Hydraulic cylinders are double acting cylinders with integrally mounted counterbalance and pilot operated check valves. Refer to the cylinder drawings for specific information.

All cylinders use a counter-balance load holding cartridge valve on the extend port. This valve performs 3 functions:

- Controls the rate of decent when lowering the load
- Keeps load from falling in the event of sudden loss of system pressure, such as when a hose bursts.
- Acts as a relief valve to prevent damage from induced load or thermal expansion.

It allows free flow to extend then blocks flow until opened by pilot pressure to the retract port or when the relief pressure is reached.

Some cylinders utilize a pilot operated check valve on the retract port to prevent the cylinder from creeping out under no load conditions. This valve allows flow into, but prevents flow from the retract port, thus hydraulically locking the cylinder until opened by pilot pressure from the extend port.

MOTORS

The hydraulic motors used by the rotation drive and hydraulic winch are high torque, low speed constant displacement motors.



MANUAL OPERATION

If electrical problems occur the solenoid valves may be operated manually. Refer to the manifold drawing for function valves and directions.

Directional control valves are manually operated by depressing the boot at the end of the valve. Use a blunt object (e.g. bolt or screwdriver handle) to assist in the operation.

Proportional valves are operated with either a boot or a small screw. Depress the boot or turn the screw slowly while operating a function to determine optimum speed. Turning the screw all the way in will result in rapid crane movement.

If hydraulic power is lost while a load is suspended, the load may be lowered by decreasing the setting on the counterbalance valve. This should only be done in extreme cases. The valve must be reset before the crane is returned to use.

To decrease the setting, loosen the locknut on the valve, then slowly turn the adjustment stem **CLOCKWISE** until the load begins to lower. Count the number of turns so that the valve can be returned to its original setting.

Alternately, a pressure gage must be put on the retract port to adjust the setting so that approx. 1800 PSI is required to lower the boom with no load.

Test the setting by lifting a known load near the moment rating of the crane.



CONTROL TROUBLESHOOTING CHART

E-STOP WIRE PENDANT FOR XP TO X CRANES

No functions working	Not receiving power Make sure E-STOP button on pendant is released (not pressed)	Check crane control socket Pin E ensure that it is receiving 12V (Make sure E-stop is released) With the plug disconnected, activate a function switch then check continuity between Pin E and the activated function/direction pin For example: activate Hoist Down and check for continuity between Pin E and Pin P
One function not working	Faulty wiring/switch malfunction	With the plug disconnected, activate the function that is not working and check for continuity between Pin E and corresponding function pin
Other	Check continuity on E-STOP button w/button released (not pressed)	Check Crane RELAY BOX for Error Codes

FIGURE

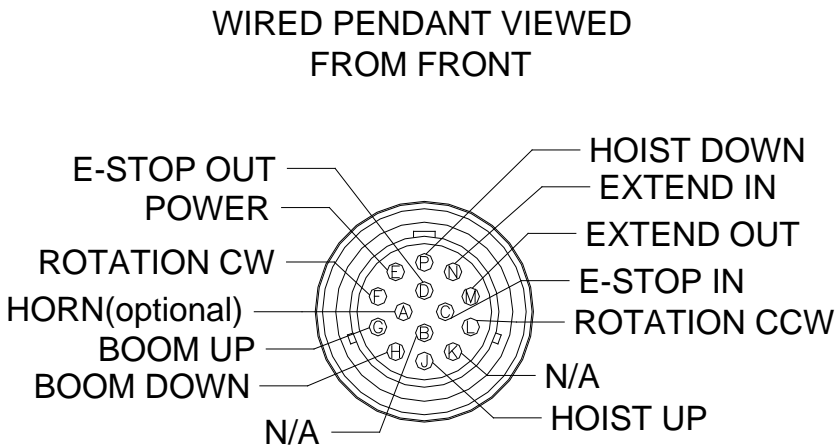
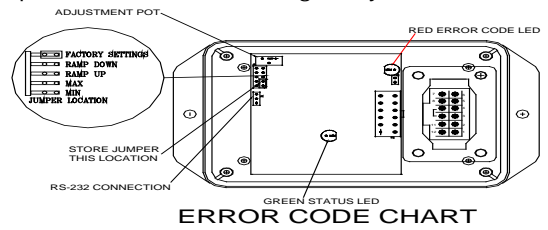

Figure 2 CONTROL PLUG ON PENDANT

To Display an error code, the controller turns on and off the error code LED a certain number of times with a pause at the end. It repeats the code until the problem is resolved. The **Error Code Chart** is provided to assist the service personnel in troubleshooting the system.



ERROR CODE CHART

ERROR CODE COUNT	PROBABLE CAUSE
1	No Input To ATB Switch Input
2	No Input To Pressure Switch Input Or Overload Condition
3	Short Or Overload To Winch Up Output
4	Short Or Overload To Elevation Down Output
5	Short Or Overload To Extension Out Output
6	Trigger Input Out Of Range

**Figure 1 RELAY BOX
SEE DWG**



TROUBLESHOOTING HYDRAULIC CRANES

GENERAL

If a problem exists, always start with the basics and work towards the more complicated.

First ensure that the crane is receiving full voltage and the pump is generating full flow and pressure. Typical requirements are 12VDC, 6GPM, and 2750PSI. Refer to the crane specification sheet for specifics.

Next determine if the problem is electrical or hydraulic. In general, if the crane can be operated manually, then the problem is electrical. If manual operation does not work then the problem is hydraulic.

If functions do not work under load or if hoist down, boom down, and extend in do not work the problem is likely lack of pressure. This may be caused by inadequate supply pressure, malfunction, contamination in the DPS or system relief valve.

If hoist up, boom down, or extend out do not work, the problem may be in the safety system. If all three of these functions do not work and other functions do the problem must be in the safety system. The status indicators on the crane RELAY BOX (see dwg.) should confirm any errors.

If the crane has proportional control and either no functions work or all functions are slow, refer to the proportional troubleshooting section.

SAFETY SYSTEM

To check functions controlled by the safety system check the status indicators. If only one of the safety functions is not working, activate that function and check for error codes and/or its output status indicator.

For non-FM systems, if the status indicator lights then the problem is in the wiring or in

the solenoid coil. If the light does not illuminate, check the control pendant. If the control pendant is good then the crane RELAY BOX needs to be replaced.

For FM systems, check for error codes. If none are present, see the FM Troubleshooting section.

If all three safety functions are not working confirm that the control board has power. Confirm that the board is receiving a signal from the ATB and load sensor. If the board is not receiving both signals Error Code 4 (Error Code 4 or 5 for the FM) should be active.

If the error code is active, ensure that the crane is not overloaded and that the ATB lever is holding the switch closed. Check for voltage at the ATB and Load Sensor inputs.

CHECK LOAD SENSOR SWITCH

If the load sensor input is not receiving voltage, locate the load sensor connector inside the crane housing. The plug side will have a red wire and a gray wire, the receptacle side will have a red and a white wire.

Disconnect and check for continuity between the two pins on the receptacle (switch side). If there is no continuity then the load sensor is bad and needs to be replaced.

CHECK ATB SWITCH

If the ATB input is not receiving voltage remove the ATB housing cover and disconnect the connector. Check for continuity on the switch side. Lifting the weight should break the continuity. If either of these conditions is incorrect the switch is bad and needs to be replaced.

CHECK CORD REEL

Check the ATB switch if not done so already. Locate the ATB connector inside the crane housing. The plug side will have a red wire and a black wire. The receptacle side will have a white wire and a black wire.

2-8

Disconnect the plug going to the switch. Check for continuity between the two pins on the receptacle. Have someone lift the weight on the ATB and continuity should be broken. If either of these conditions are incorrect then the cord reel is bad and needs to be replaced.

CHECK POWER TO SAFETY SWITCHES

If the safety switch is good, check for voltage at pin 1 (the red wire) on the plug. If there is no voltage, follow the wire back to the 6-pin power distribution plug, checking for breaks or shorts.

Remove the power distribution receptacle (cap).

NOTE!

Removing the cap will disconnect power to all electrical components. Be sure to replace the cap before continuing.

Check the cap for bent pins. Check that all wires are fully seated in the plug. If they are not, then remove the green locking wedge and push the wires forward until seated. Reinstall the wedge ensuring that no wires are pushed back.

Check the input voltage to the plug (the pin the fuse holder is connected to). If there is no voltage there, then no component will get power. Check the fuse in the crane and any other fuse or circuit breaker that may be installed. Start at the battery and trace the wiring back to the crane checking for power at each component until the problem is found.

SOLENOID VALVES

If one function does not work, try to operate it manually. If it does not work either the solenoid or the applicable actuator is malfunctioning. Contact Liftmoore for more information.

If it works manually, then the problem is electrical. Disconnect the electrical connector going to the applicable solenoid valve.

Check the voltage between the applicable direction pin on the plug (harness side) and ground. When the switch is activated, the voltage should be 12V (battery voltage).

If no voltage is received, check the continuity between the pin and the applicable pin on the crane control socket. If there is no continuity, then a wire must be broken. If the wiring is good, then the problem is with the control pendant.

If the voltage checks good, check the resistance on the coil. Connect an ohmmeter to the applicable pin on the receptacle and ground. The resistance should be between 5 and 6 ohm. If the resistance is near zero then the coil is shorted and needs to be replaced.

If the circuit is open then check where the coil is grounded on the valve. Also check for continuity between the manifold and the crane. If there is no continuity, remove one of the manifold mounting bolts and clean under the head and reinstall.

PENDANT NON - FM

If no functions work, check that Pin E on the crane control socket has power.

If the crane control socket is getting power, then check that the power wire is not broken. Select a function and direction then check continuity between pin E and the activated function/direction on the pendant control plug. If there is no continuity then the pendant needs to be repaired or replaced.

If a function is not working, check continuity between that function and Pin E on the pendant control plug. There should be continuity once the switch is activated in selected direction. The continuity should break when the switch is released. If not, the pendant needs to be repaired

DEUTSCH CONNECTIONS & PINS

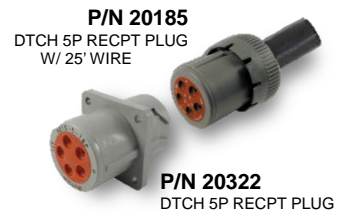

FEMALE'S

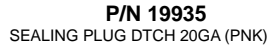

MALE'S

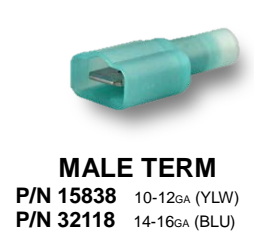
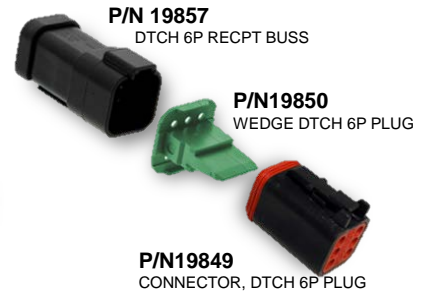
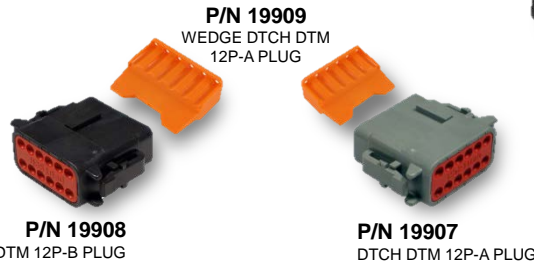
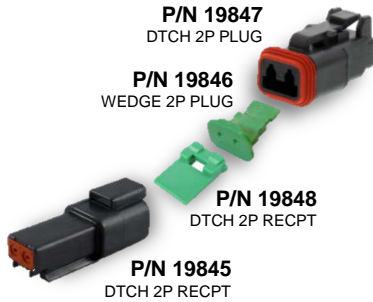

F2435-0
06/16/16
I:FORMS

HOUSTON, TEXAS
FAX: (800) 824-5559 (USA & Canada)
FAX: (713) 688-6324
PHONE: (713) 688-5533
www.liftmoore.com

SECTION 3 CRANE SPECIFICATIONS

MODEL 1032 CRANES

MOMENT RATING 10 000 FT-LBS

MAX SINGLE LINE LOAD 1 600 LBS
MAX DOUBLE LINE LOAD 3 200 LBS

LIFTING CAPACITIES AT VARIOUS LOAD RADII

LOAD RADIUS (FT)	CAPACITY (LBS)
<3.2	3200
5	2000
7	1429
9	1111
11	909
13	769
15	667
17	588
20	500

POWERED FUNCTIONS AND EXPECTED TIMES

WINCH	UP: 3 s	DOWN: 3 s	1 REVOLUTION
BOOM ELEVATION	UP: 7.4 s	DOWN: 7.0 s	
BOOM EXTENSION	OUT: 12.2 s	IN: 11.8 s	
ROTATION	90° 10.6 s		

HYDRAULIC REQUIREMENTS:

PRESSURE	2500 PSI
FLOW	6 GPM

ELECTRICAL REQUIREMENTS

VOLTAGE	12 VDC
FUSE	15 AMP

NOTE: FUNCTION TIMES ARE BASED ON THESE INPUT VALUES



F1642-B
1/22/16

HOUSTON, TEXAS
FAX: (800) 824-5559 (USA & Canada)
FAX: (713) 688-6324
PHONE: (713) 688-5533
www.liftmoore.com

PERIODIC MAINTENANCE SCHEDULE MODEL 1032 CRANES		
BOLTS		
MOUNTING BOLTS	1/2-20 GRADE 8 TORQUE 120 FT-LBS DRY	EVERY 4 MONTHS
LUBRICATION		
GREASE FITTINGS	SEE DRAWING 50460	EVERY OTHER WEEK
HYDRAULIC FLUID	STANDARD Chevron AW Hydraulic Oil 46 or equivalent SAE 15 weight oil COLD WEATHER AW 32 or equivalent SAE 10 weight oil	CHECK DAILY, FILL AS NEEDED
ROTATION GEARBOX	Sunep 460 gear oil or AGMA Grade 7EP oil	EVERY MONTH
BEARING (ZERK AND TEETH)	Oil Center Research PM 600 Military grease or equivalent Benton Based Grease NLGI Grade 2	EVERY 6 HOURS OF OPERATION



CRANE LUBRICATION POINTS

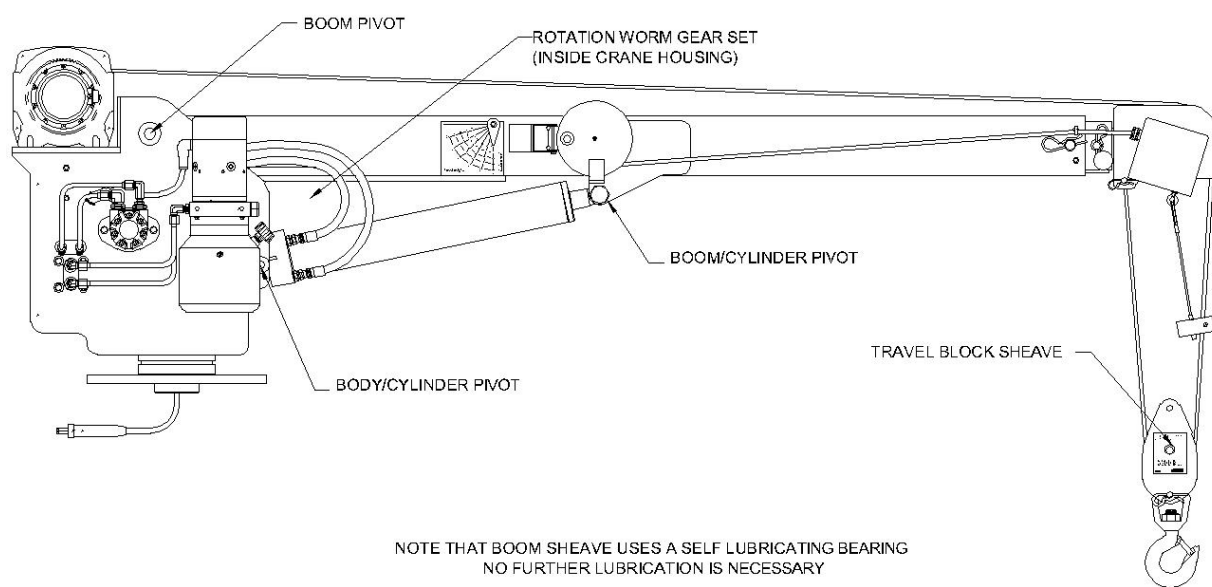

Houston TX
(713)-688-5533
www.liftmoore.com

DRWN BY: BLF
DATE: 3/18/03

CRANE LUBRICATION POINTS 8.1K-16K

DRAWING NO.

50460-A



F1642-B
1/22/16

HOUSTON, TEXAS
FAX: (800) 824-5559 (USA & Canada)
FAX: (713) 688-6324
PHONE: (713) 688-5533
www.liftmoore.com

THIS PAGE INTENTIONALLY LEFT BLANK



F1642-B
1/22/16

HOUSTON, TEXAS
FAX: (800) 824-5559 (USA & Canada)
FAX: (713) 688-6324
PHONE: (713) 688-5533
www.liftmoore.com

LIST FOR BOX, CRANE PARTS 1032X-11

Items with * have detailed DWG's.

P/N 26013 - BOX, CRANE PARTS 1032X-11
ATB LEFT SIDE, WINCH 25048, ROTATION ADJUSTER

- 1) P/N 26011- MANUAL, CRANE 1032X E-STOP.....1pc
- 2) P/N 21154 - FUSE, 30 AMP BLADE.....1pc
- 3) P/N 18457 - FUSE HOLDER, ATO 12GA SEALED.....1pc
- 4) P/N 19487 - CW, 10 GA X 300".....1pc
- 5) P/N 30815 - SCREW, HHC 0.50-13 X 2.50 GR8.....4pcs
- 6) P/N 30474 - WASHER, LOCK 0.50 GR5 PLATED.....4pcs
- 7) P/N 31957 - NUT, HEX 0.50-13 GR8 PLATED.....4pcs
- 8) *P/N 22556 - BLOCK, TRAV ASSY 3.2K lbs /4.0D.....1pc
- 9) P/N 32613 - ADAPTER, 8MJ-10MJ.....1pc
- 10) P/N 32545 - ADAPTER, 6MP-8MJ.....1pc
- 11) P/N 32546 - ADAPTER, 6MP-10MJ.....1pc
- 12) P/N 31864 - ADAPTER, 6FP-6MP SWIVEL.....2pcs
- 13) P/N 17012 - SWITCH, TOGGLE SPST MAINT. /S.....1pc
- 14) P/N 17011 - BRACKET, SWITCH MNT. HYD. CRN.....1pc
- 15) P/N 16781 - TERMINAL, RING 10-12 GA #8.....2pcs
- 16) P/N 17013 - PLATE, ON-OFF FOR TOGGLE SWCH.....1pc
- 17) P/N 18600 - PLATE, CRANE-TRUCK STABILITY CHART.....1pc
- 18) P/N 22430 - INSTALLATION INTS. 1032.....1pc
- 19) P/N 24945 - DECAL, LOAD CAPACITY 10,000.....1pc



F2128-A
05/19/15

HOUSTON, TEXAS
FAX: (800) 824-5559 (USA & Canada)
FAX: (713) 688-6324
PHONE: (713) 688-5533
www.liftmoore.com

UNDER WIND WIRE ROPE ON WINCH

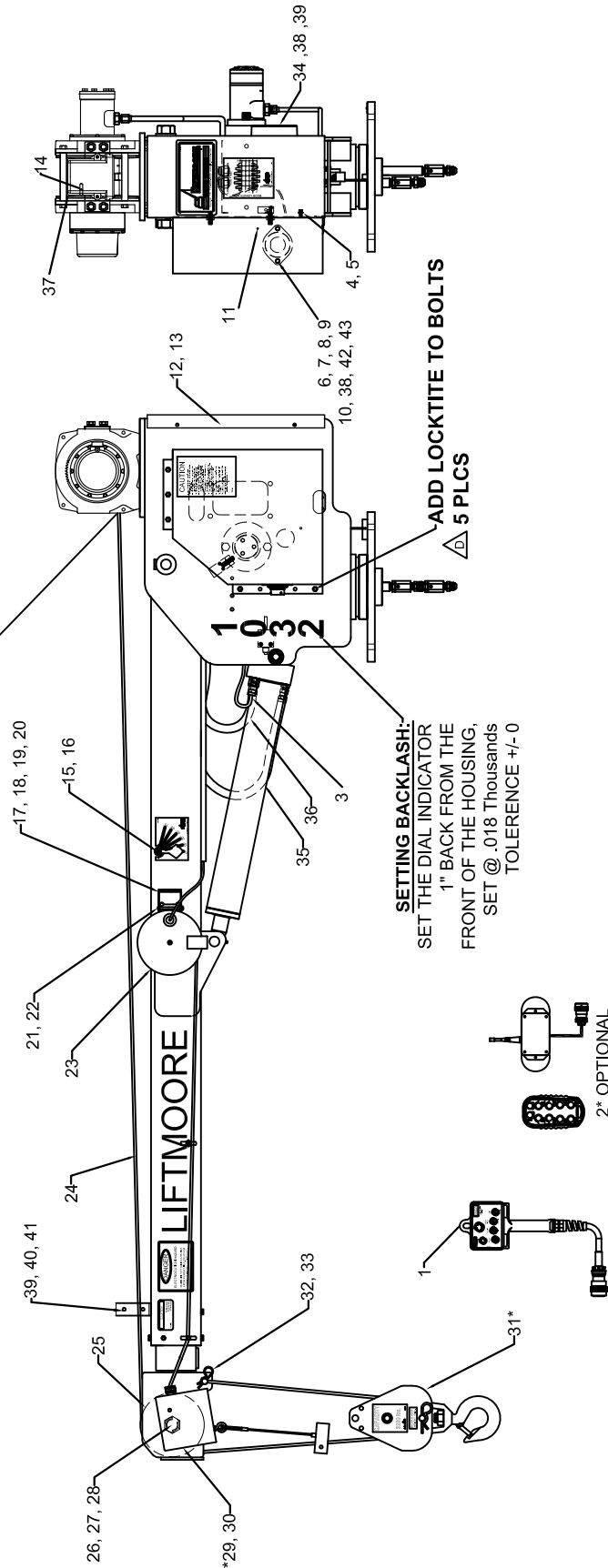

ITEMS WITH * HAVE DETAIL DRAWINGS

#	PN	DESCRIPTION	QTY	#	PN	DESCRIPTION	QTY	#	PN	DESCRIPTION	QTY
1	25329	CONTROL, PENDANT 1032X	1	18	30833	NUT, HEX NYLOC 0.25-20 GR2	2	35	33975	HOSE, HYD #6 47.00"	1
2	25058	CONTROL, FM ASSY MEGA(OPTIONAL)	1	19	31110	WASHER, FLAT 0.25 GR5 PLATED	2	36	33999	HOSE, HYD #6 42.00" ST-ST	1
3	21213	SWITCH, PRES ASSY 1450PSI DTCH	1	20	30457	SCREW, HHC 0.25-20 X 0.75 GR5	2	37	24197	BOARD, PCB XP TO X	1
4	31933	SCREW, SOC HD 0.25-20 X 0.50 (GRND)	1	21	33410	SCREW, MH RD 10-24 X 3.00	1	38	17164	SCREW, SOC HD 10-24 X 0.62	2
5	30889	WASHER, LOCK 0.25 GR5 PLATED	1	22	33409	NUT, HEX NYLOC 10-24 GR2	1	37	32639	WASHER, LOCK #10	2
6	25088	EWH, DTCH HYD XP TO X	1	23	20407	REEL, CORD 20 FT ASSY DTCH	1	38	20815	PLATE, CONTROL SOCKET 5-PIN MC	2
7	30457	SCREW, HHC 0.25-20 X 0.75 GR5	2	24	32995	ROPE, WIRE 0.25 X 62' W/THB&LP	1	39	24366	ROLLER, ROPE LAGK NYLON	2
8	31110	WASHER, FLAT 0.25 GR5 PLATED	2	25	33058	SHEAVE ASSY 5.90PD X 0.25 ROPE	1	40	24367	SCREW, HHC 0.25-20 X 5.50 GR5	2
9	30889	WASHER, LOCK 0.25 GR5 PLATED	2	26	34468	SCREW, SHEAVE SINGLE 1-8 3.25	1	41	30833	NUT, HEX NYLOC 0.25-20 GR2	2
10	30830	NUT, HEX 0.25-20 GR2 PLATED	2	27	31258	WASHER, FLAT 1.00 SAE GRADE 8	1	42	18754	NUT, SOCKET LOCK-14 DEUTSCH	1
11	30989	SCREW, HWHSMS #8 X 0.50	1	28	30838	NUT, HEX NYLOC 1.00-8 GRADE 5	1	43	18755	WASHER, SOCKET LOCK-14 DEUTSCH	1
12	25248	COVER, BACK 1032 PLASTIC	1	29	22908	ATB ASSY, DEUTSCH CONNECTOR	1	NOT SHOWN:			
13	32589	SCREW, HWHSMS 0.25-20 X 0.75	4	30	32957	CLAMP, HOSE SUPPORT 0.62 ID	1	19847	19847	CONNECTOR, DTCH 2P PLUG	1
14	70022	WEDGE, WIRE ROPE ANCHOR	1	31	22556	BLOCK, TRAV ASSY 3.2K lbs/4.0D	1	19845	19845	CONNECTOR, DTCH 2P RECPT	1
15	22394	PENDULUM, LOAD RADIUS DIA. HD	2	32	22553	PIN, CLEVIS 0.56 X 2.5 PLATED	1	19846	19846	WEDGE, DEUTSCH 2P PLUG	1
16	31017	SCREW, SHOULDER 0.31-18 X 0.75	2	33	31603	CLIP, HAIRPIN 0.50 - 0.62	1	19848	19848	WEDGE, DEUTSCH 2P RECPT	1
17	70012	BRACKET, CORD REEL	1	34	24729	BOARD, RELAY XP TO X	1	33025	33025	PLATE, SERIAL 3200/1032	1
									21650	DECAL KIT 1032 DTCH	1



Houston TX
(713)-688-5533
www.liftmoore.com

DRWN BY: AA
DATE: 08/08/13

CRANE ASSY 1032X-11
ATB LEFT SIDE, XP TO X W/HORN; ROTATION ADJUSTER

DRAWING NO.

26012-D

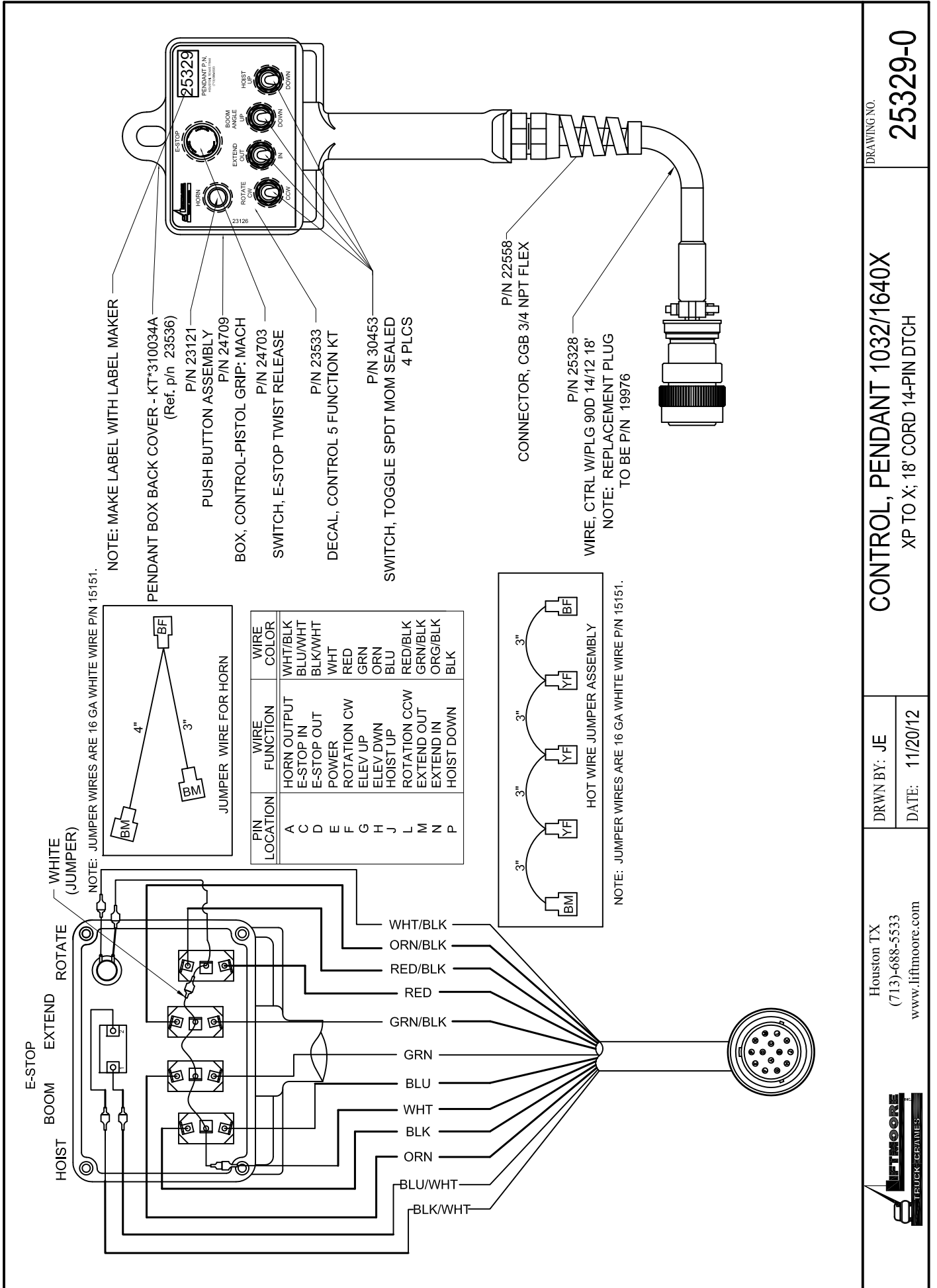

Houston TX
(713)-688-5533
www.liftmoore.com

DRWN BY: JE
DATE: 11/20/12

CONTROL, PENDANT 1032/1640X
XP TO X; 18' CORD 14-PIN DTCH

DRAWING NO.
25329-0

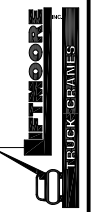

3RD GENERATION RELAY BOARD	
Pin No.	Description
1	Ground
2	Trigger Signal Input
3	Proportional Valve Output
4	Pressure Switch Input
5	ATB Switch Input
6	Winch Up Switch Input
7	Elevation Down Switch Input
8	Extension Out Switch Input
9	Extension Out Output
10	Elevation Down Output
11	Winch Up Output
12	Supply (9 To 30 VDC)

ERROR CODE CHART

ERROR CODE COUNT	PROBABLE CAUSE
1	No Input To ATB Switch Input
2	No Input To Pressure Switch Input Or Overload Condition
3	Short Or Overload To Winch Up Output
4	Short Or Overload To Elevation Down Output
5	Short Or Overload To Extension Out Output
6	

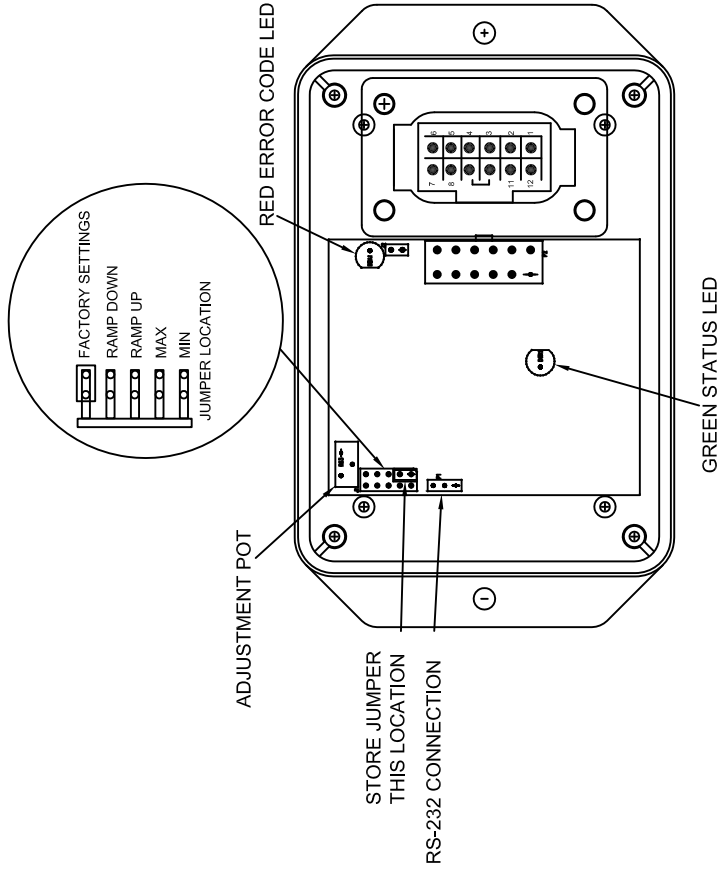

To Display an error code, the controller turns on and off the error code LED a certain number of times with a pause at the end. It repeats the code until the problem is resolved. The **Error Code Chart** is provided to assist the service personnel in troubleshooting the system.



Houston TX
(713)-688-5533
www.liftmoore.com

DRWN BY: JE
DATE: 11/21/12

BOARD, RELAY 3RD G XP TO X
REPROGRAMMED FOR 1032X

DRAWING NO.

24729-B

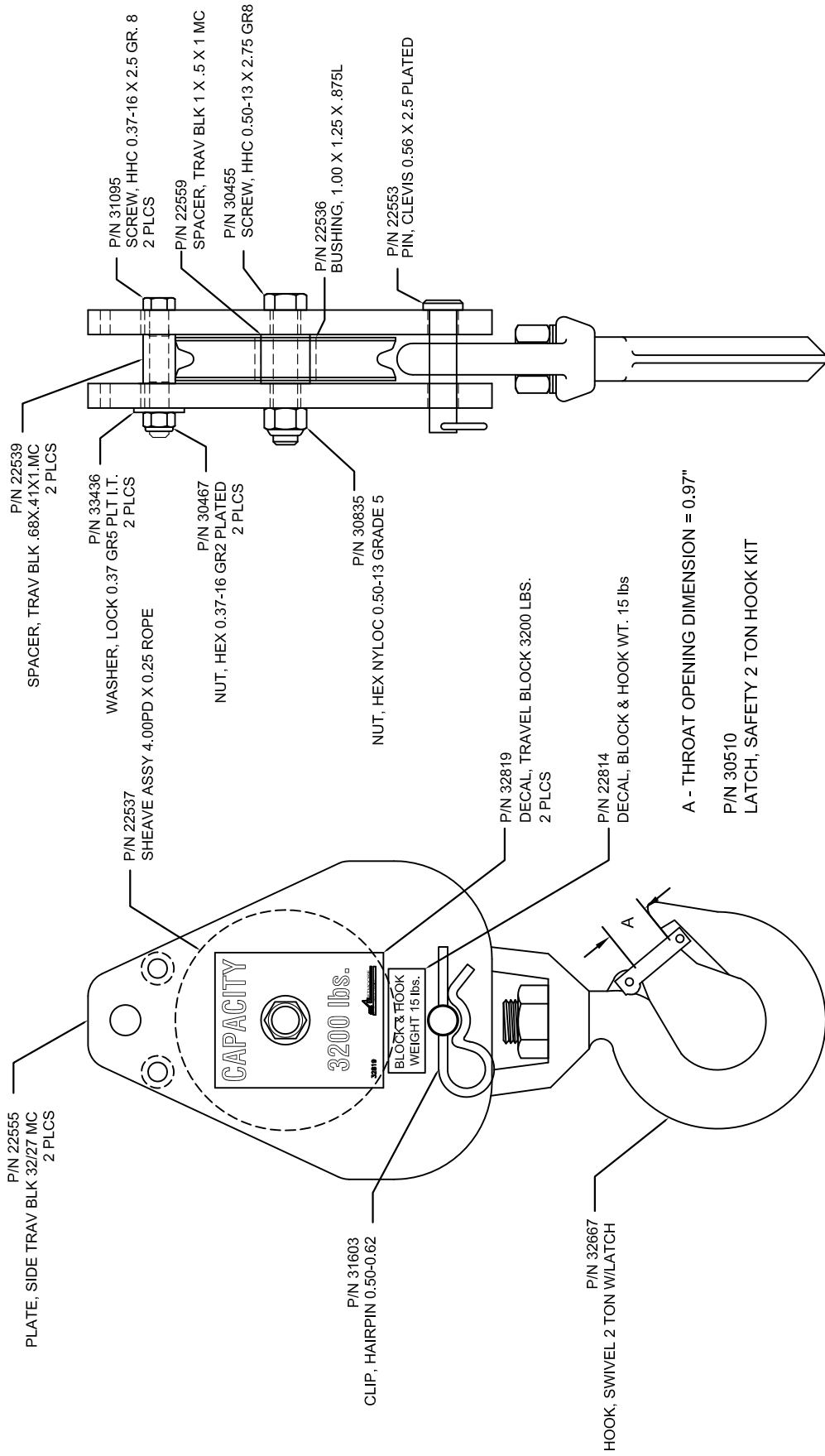

CAUTION:

NEVER USE A HOOK WHOSE THROAT OPENING HAS BEEN INCREASED, OR WHOSE TIP HAS BEEN BENT MORE THAN 10 DEGREES OUT OF PLANE FROM THE HOOK BODY, OR IS IN ANY WAY DISTORTED OR BENT.

	Houston TX (713)-688-5533 www.liftmoore.com	DRAWN BY: JC DATE: 6/23/08	BLOCK, TRAV ASSY 3.2K lbs/4.0D 4.00PD X 0.25 ROPE; 3200 LBS	DRAWING NO. 22556-C
--	---	-------------------------------	--	-------------------------------

NOTE: WIRE SHOULD BE SECURED TO SHEAVE BOLT TO ENSURE THAT IT DOES NOT INTERFERE WITH THE LEVER

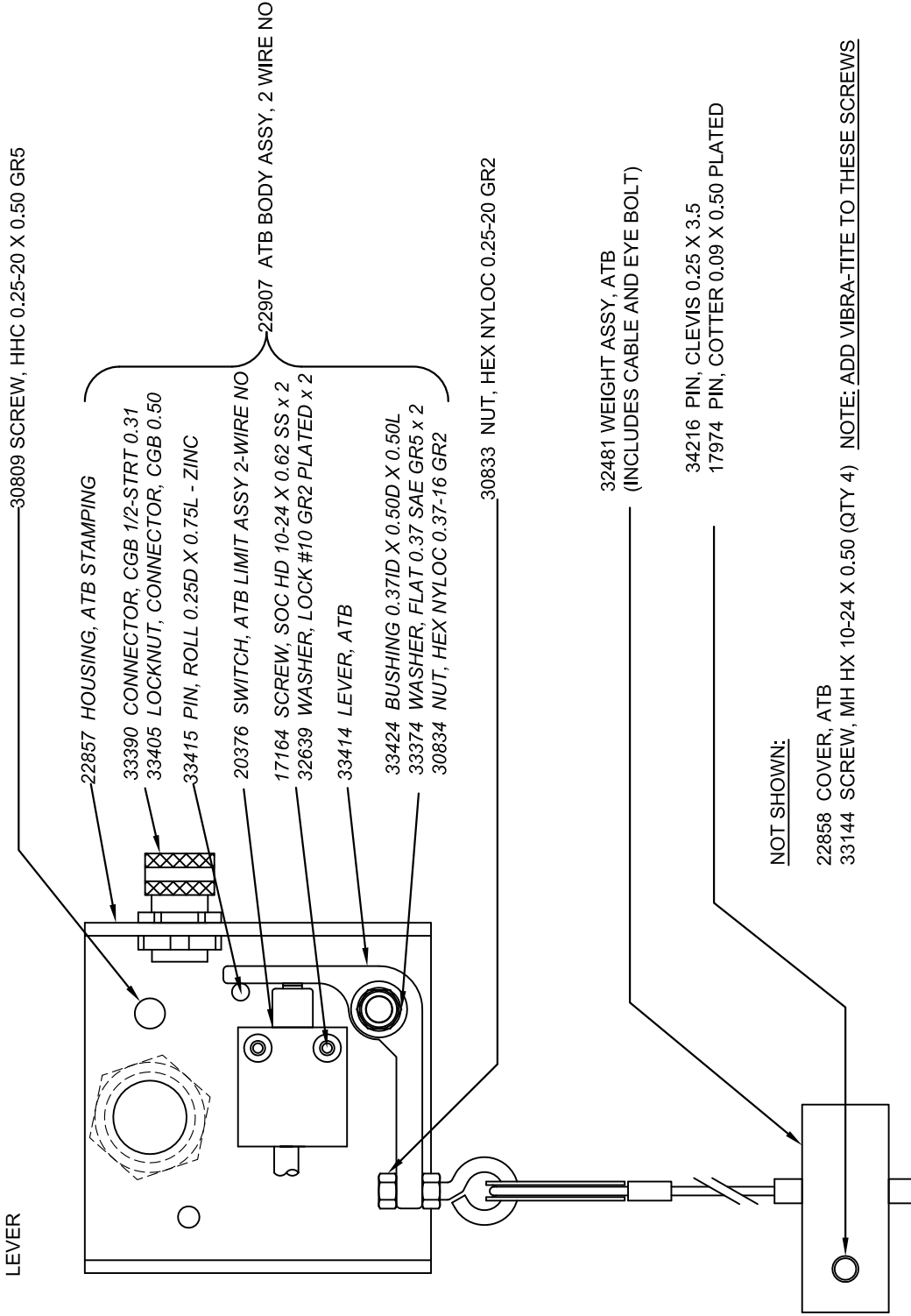

Houston TX
(713)-688-5533
www.liftmoore.com

DRWN BY: JC
DATE: 07/02/09

ATB ASSY, DEUTSCH CONN
TWO-WIRE NORMAL OPEN; LEFT SIDE

DRAWING NO.

22908-B

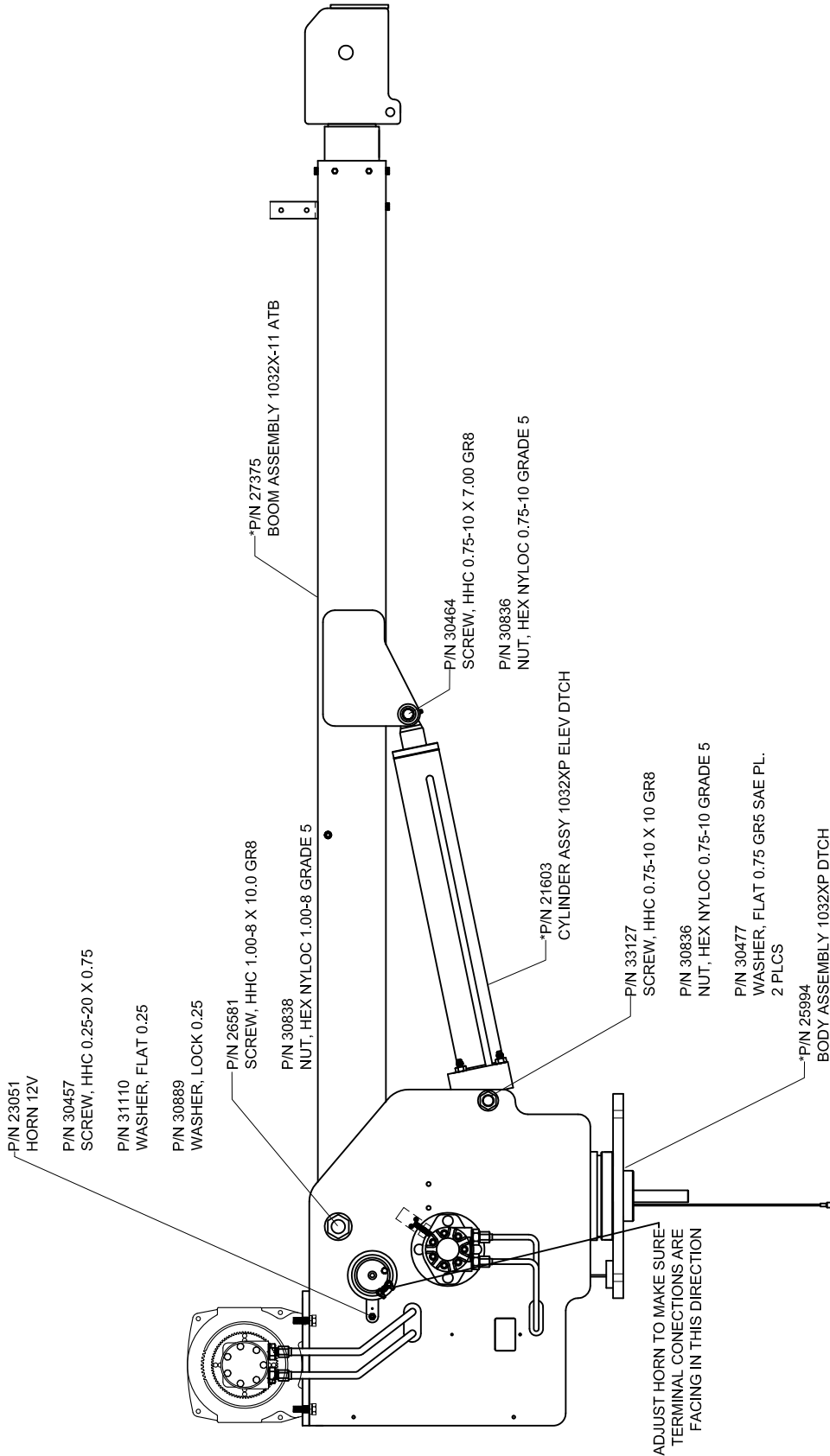

ADJUST HORN TO MAKE SURE
 TERMINAL CONNECTIONS ARE
 FACING IN THIS DIRECTION

ITEMS WITH * HAVE DETAIL DRAWINGS

DRAWING NO.
26010-B

BOOM-BODY ASSY 1032X/XP-11 DTCH
 L.S. ATB, WINCH 25048, HORN, ROTATION ADJUSTER

DRWN BY: AA
 DATE: 08/08/13

Houston TX
 (713)-688-5533
 www.liftmoore.com



P/N 21213
SWITCH, PRES ASSY 1450PSI DTCH
(NOT PART OF ASSEMBLY)

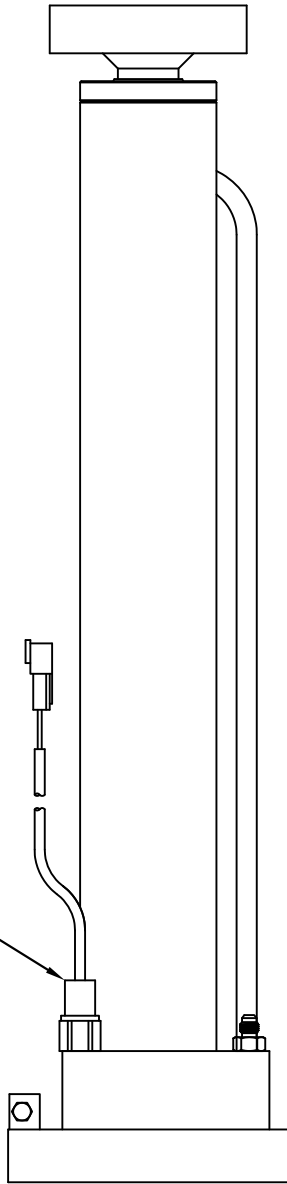

P/N 31063
ADAPTER, 6MJ-6MO
2 PLCS

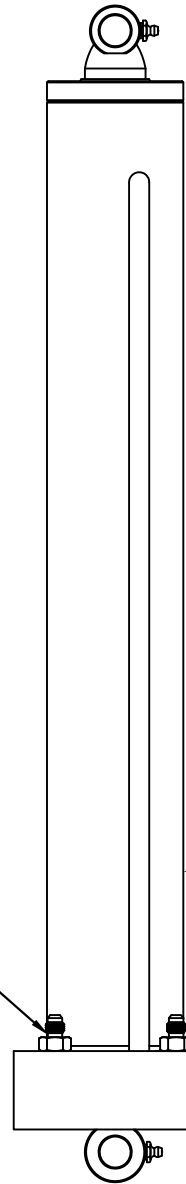

P/N 32867
CYLINDER, 3.0 X 18.5 X 1.25 PE

REPLACEMENT PARTS FOR CYLINDER	
DESCRIPTION	PART NUMBER
SEAL KIT	TM*SK-0000148
COUNTER BALANCE VALVE	30851

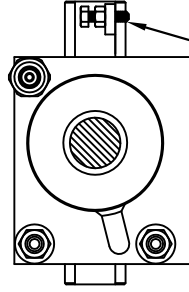

P/N 30810
SCREW, HHC 0.25-20 X 1.00 GR5

P/N 30830
NUT, HEX 0.25-20 GR2 PLATED

FOR UPLIMIT SWITCH

Houston TX
(713)-688-5533
www.liftmoore.com



CYLINDER ASSY 1032XP ELEV DTCH

DRWN BY: JC
DATE: 05/23/08

DRAWING NO.

21603-A

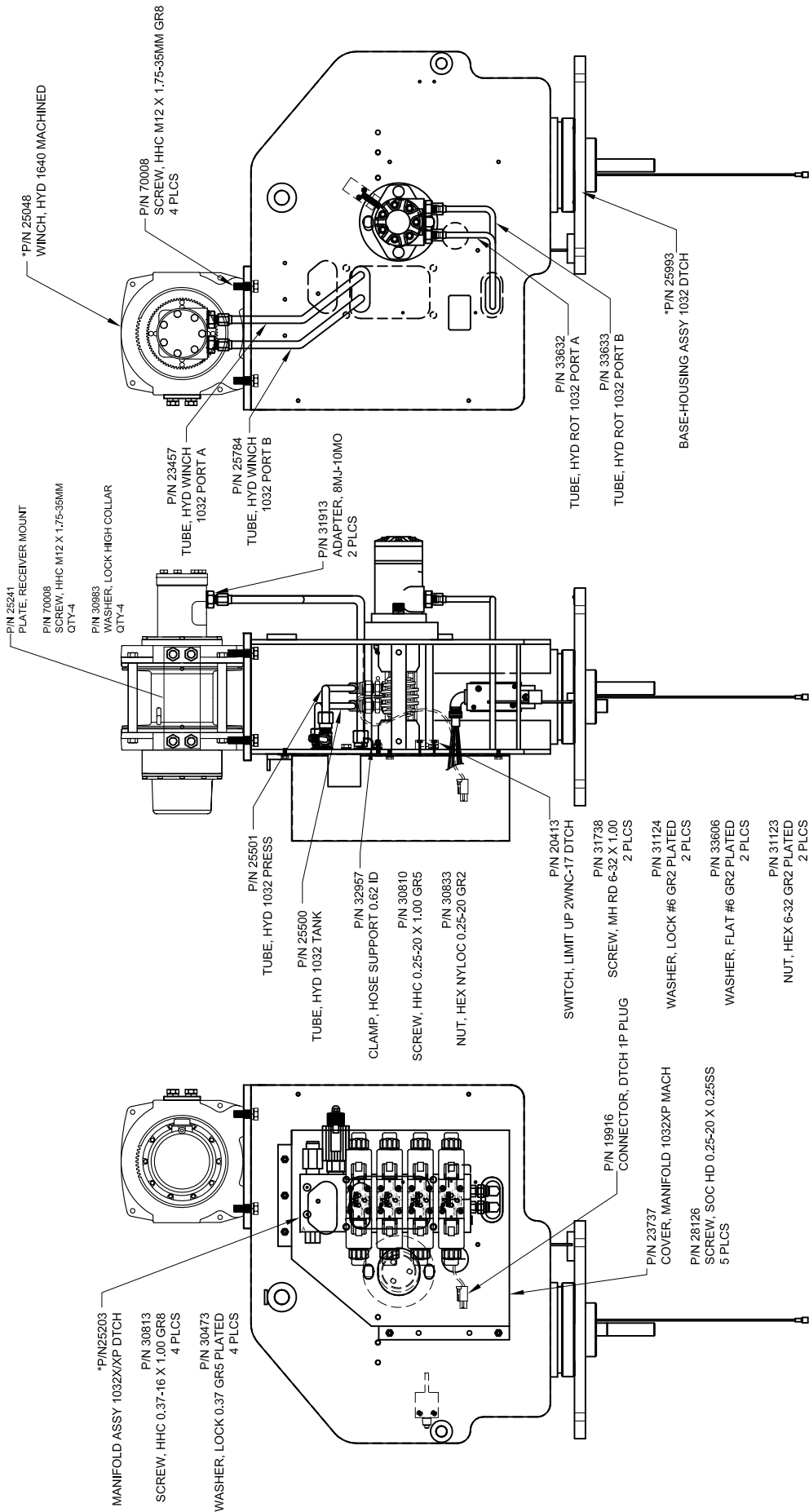

ITEMS WITH * HAVE DETAIL DRAWINGS

DRWN BY: AA
 DATE: 08/07/13

Houston TX
 (713)-688-5533
 www.iftmoore.com



DRAWING NO.

BODY ASSEMBLY 1032XP DTCH
 USE WINCH P/N 25048; DEUSTCH VALVES, ROTATION ADJUSTER

25994-D

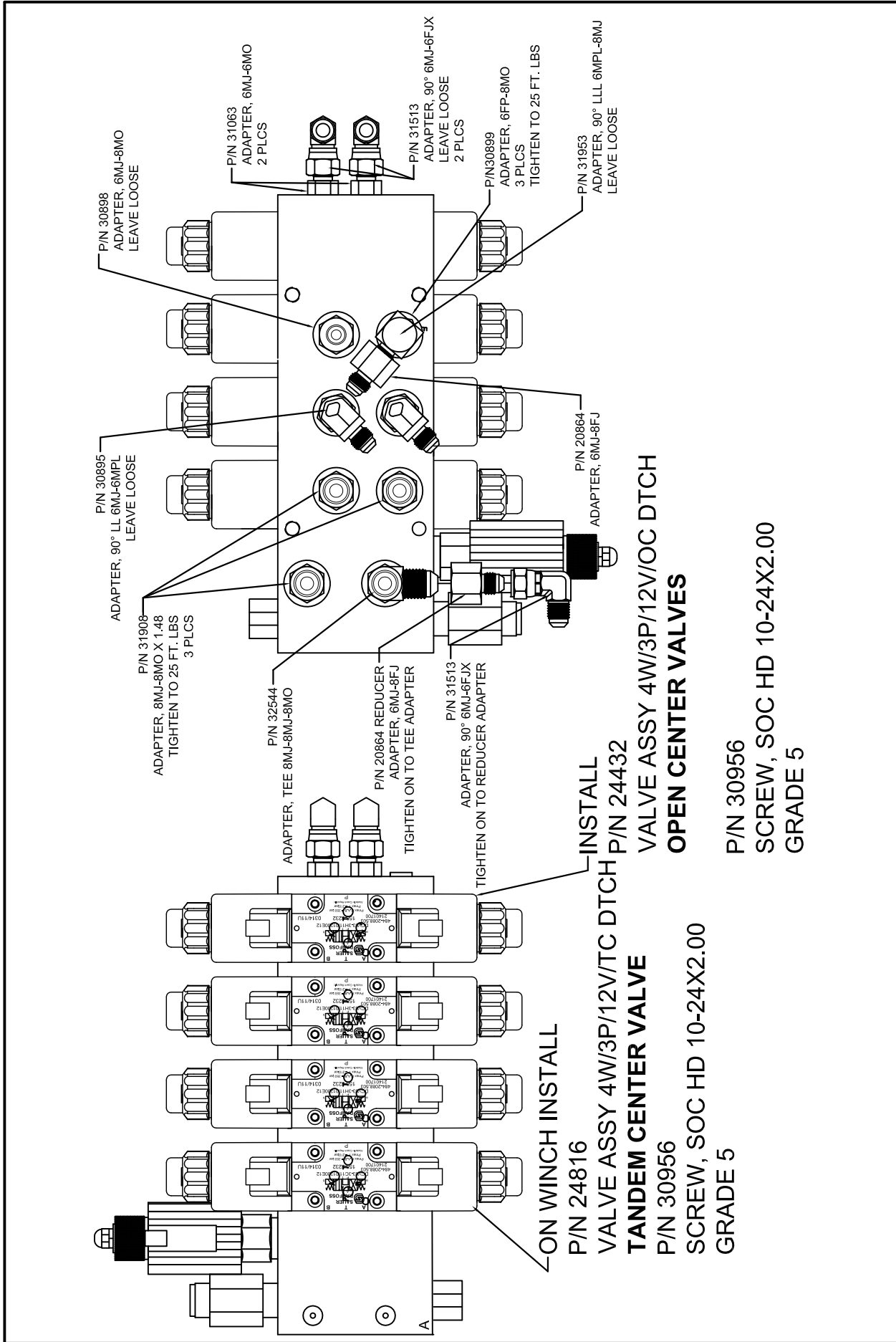

DRAWING NO.
25203-D

MANIFOLD ASSY 1032X/XP DTCH
DEUSTCH VALVES

DRWN BY: JE
DATE: 9/25/12

Houston TX
(713)-688-5533
www.liftmoore.com



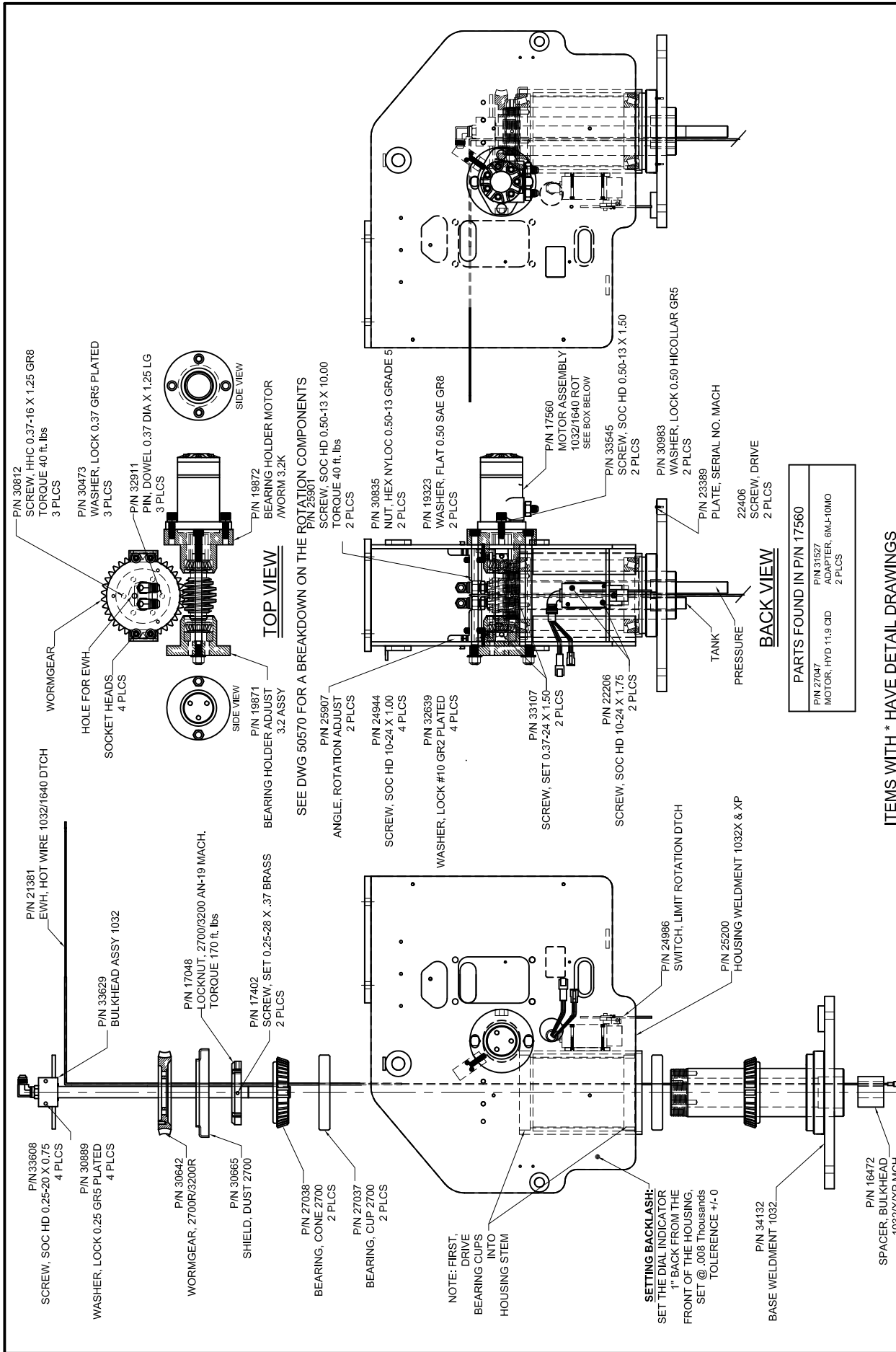

DRAWING NO. **25993-0**

BASE-HOUSING ASSY 1032 DTCH
USE WINCH P/N 25048; 22209 RB, ROTATION ADJUSTER

DRWN BY: AA
DATE: 08/07/13

Houston TX
(713)-688-5533
www.liftmoore.com



TO ADJUST BACKLASH BETWEEN GEARS:

LOOSEN MOUNTING BOLTS

MAKE SMALL ADJUSTMENTS TO THE BACKLASH ADJUSTMENT SCREWS. NO MORE THAN A 1/4 TURN. ALTERNATE BETWEEN SCREWS SO THAT ALIGNMENT IS MAINTAINED.

SOME PLAY **MUST** BE LEFT BETWEEN THE GEARS OR THE CRANE WILL NOT OPERATE PROPERLY AND EXCESSIVE WEAR AND/OR DAMAGE WILL OCCUR. INITIAL SETTING IS SUCH THAT THE RETRACTED BOOM TIP MOTION IS LESS THAN 1 INCH.

WHEN FINISHED, TORQUE THE MOUNTING BOLTS TO 40 FT.-LBS

TO ADJUST PLAY IN WORM MOUNTING:

TIGHTEN THE 3 SET SCREWS IN THE BEARING HOLDER THEN BACK THEM OUT 1 TURN

SCREW THEM BACK IN JUST UNTIL THEY ARE SNUG. OVER TIGHTENING WILL PUT THE WORM AND MOTOR IN A BIND AND IT WILL NOT FUNCTION PROPERLY.

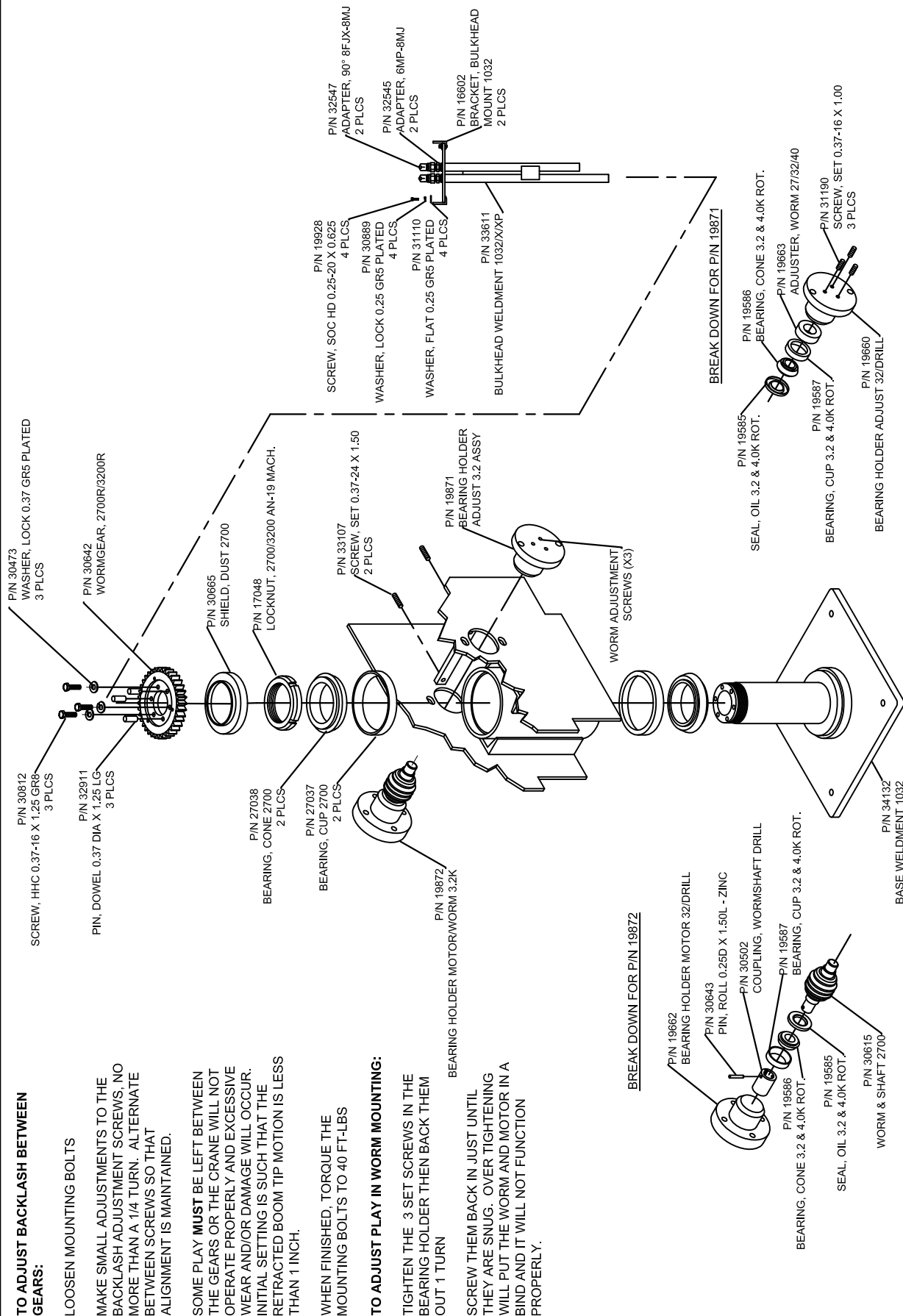

Houston TX
(713)-688-5533
www.liftmoore.com

DRWN BY: JC
DATE: 02/23/10

ROTATION COMPONENTS 1032

DRAWING NO.

50570-B

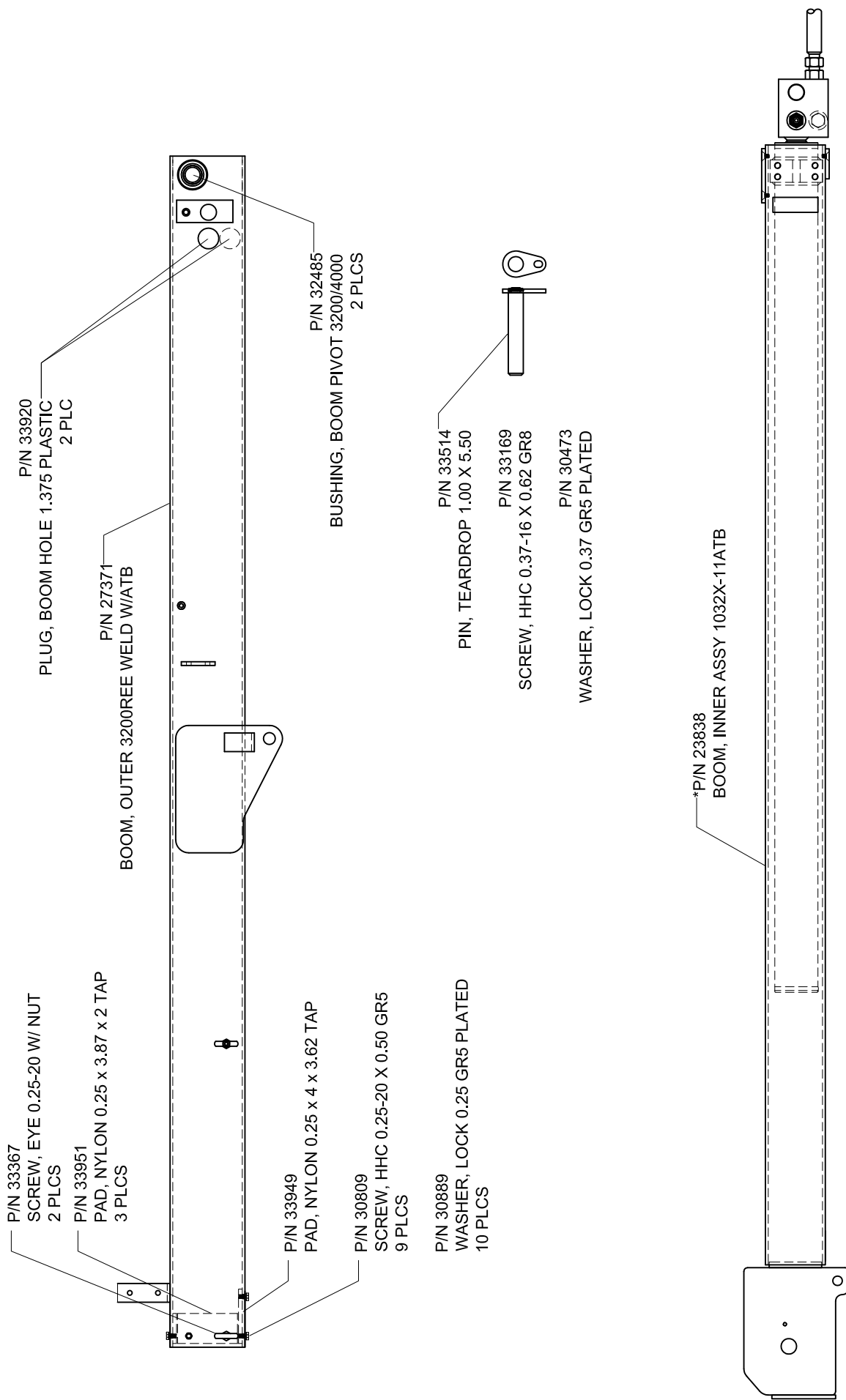

ITEMS WITH * HAVE DETAIL DRAWINGS

DRWN BY: JE

DATE: 6/2/15

Houston TX
(713)-688-5533
www.liftmoore.com

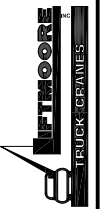

BOOM ASSEMBLY 1032X-11
L.S. ATB, ROLLER BRACKET

DRAWING NO.

27375-0

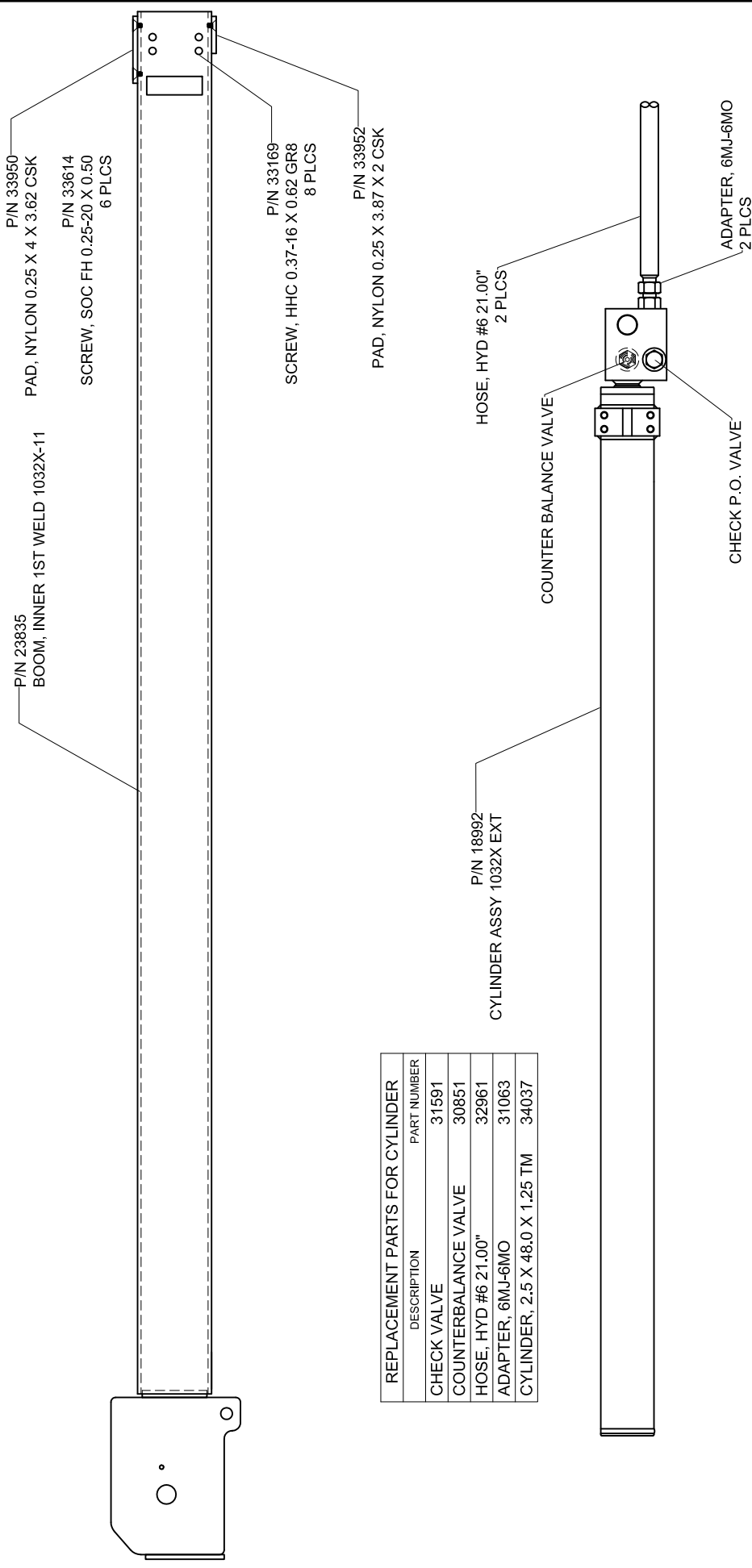

REPLACEMENT PARTS FOR CYLINDER	
DESCRIPTION	PART NUMBER
CHECK VALVE	31591
COUNTERBALANCE VALVE	30851
HOSE, HYD #6 21.00"	32961
ADAPTER, 6MJ-6MO	31063
CYLINDER, 2.5 X 48.0 X 1.25 TM	34037

Houston TX (713)-688-5533 www.liftmoore.com	DRAWN BY: IS	BOOM, INNER ASSY 1032X-11 E-STOP; L.S. ATB; 23799 MANIFOLD; RB 22209	DRAWING NO. 23838-0
	DATE: 06/29/10		



P/N 25048: WINCH, HYD WARN HY2000

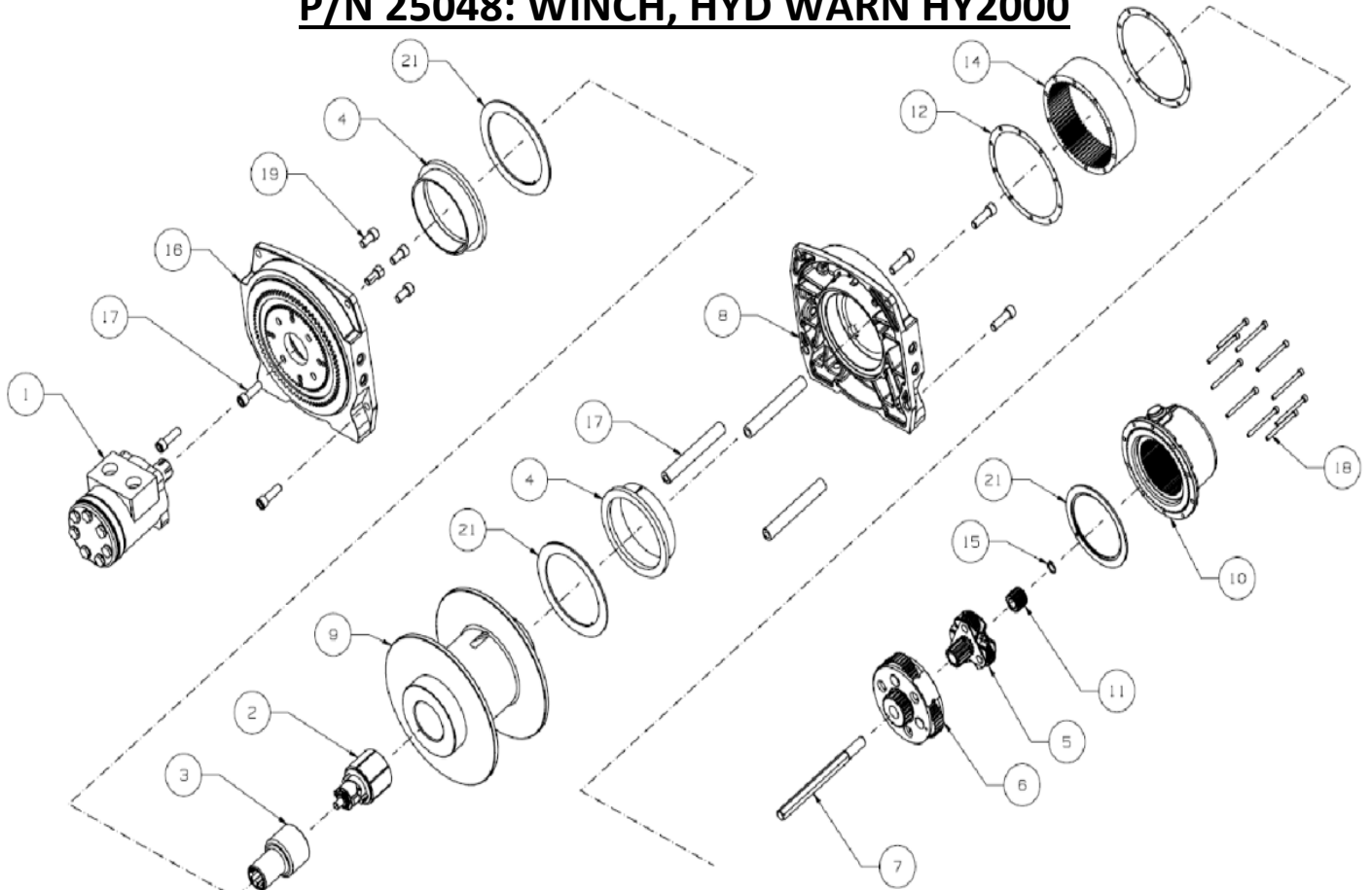

1	SVC KIT MOTOR, HYD, 1.5	90132
2	S/P BRAKE ASSY, HYDRAULIC	95320
3	DRIVER, BRAKE, HYD, DISK BRAKE	30259
4	BUSHING, DRUM, NYLON	30274
5	CARRIER (PH) ASSY, STAGE 2	34342
6	CARRIER ASSY, (PH) STAGE 3	23444
7	DRIVE SHAFT, 6.30 X .50, W/GROOVE	89096
8	(MTO)S/P DRUM, SUPPORT GEAR END	85575
9	DRUM, (KB) 2000-LF	87579
10	SVC KIT END HOUSING ASSY, CLUTCH PL	85583
11	GEAR, SUN, 18 TEETH, .50 HEX	39479
12	HOUSING, GASKET	13848
13	PARTS PACK, (PH) DC3000 HOIST	39921
14	RING GEAR, ARG, 75 TOOTH	25308
15	RING, RETAINING, 1/2	1159
16	(MTO) DRUM SPT, MOTOR END	31670
17	SVC KIT TIE ROD, ALUM, .625 X 4.58	85578
18	CPSCR, SOC, 10-24 X 2.25	13850
19	CPSCR, SOC HD, 3/8-16 X .75	30328
20	WSHR, THRUST, NYLON, MIDRANGE	13826
21	WSHR, THRUST, NYLATRON, CIM	30277

CHECK P/N 25302 DRAWING FOR DETAIL

Wire Color	Wire Length	Connectors	Function
BLK	20"	TBS-1	HOIST DWN
GRN	20"	TBS-2	ELEV UP
ORG/BLK	20"	TBS-3	EXT IN
RED	20"	TBS-4	ROT CW
RED/BLK	20"	TBS-5	ROT CCW

CIRCUIT NUMBER AND DESCRIPTION

Wire Color	Wire Length	Connectors	Function
BLU/BLK	30"	J14-A	HORN OUTPUT
YEL	25"	J14-D	E-STOP OUT
WHT	15"	J14-E	PWR, SOC
RED	14"	J14-F	ROT CW
GRN	14"	J14-G	ELEV UP
ORN	34"	J14-H	ELEV DWN
BLU	34"	J14-J	HOIST UP
RED/BLK	14"	J14-L	ROT CCW
GRN/BLK	34"	J14-M	EXT OUT
ORN/BLK	14"	J14-N	EXT IN
BLK	14"	J14-P	HOIST DWN
BRN	13"	J14-B	FM GRND
BLU	47"	P12DR.9	HOIST UP SW
ORG	47"	P12DR.10	ELEV DWN SW
GRN/BLK	47"	P12DR.11	EXT OUT SW
WHT/BLK	47"	P12DR.12	TRIGGER SGN IN
BRN	32"	P12A.1	R.B. GRND
YEL/BLK	29"	P12A.3	E-STOP IN
GRY	24"	P12A.4	PRESS SW
BLK	24"	P12A.5	ATB
WHT	41"	P12A.9	EXT. OUT VAL
YEL	40"	P12A.10	ELEV DWN VAL
PUR	43"	P12A.11	HOIST UP VAL
YEL	N/A	P6.1	MAIN PWR
RED	28"	P6.2	P12A.12
RED	18"	P6.4	P2-ATB.1
RED	18"	P6.5	P2-PS.1
GRN	29"	P2-U.2	ELEV UP
BLK	28"	TBS-1	HOIST DWN VAL
GRN	16"	TBS-2	ELEV UP VAL
ORG/BLK	26"	TBS-3	EXT IN VAL
RED	20"	TBS-4	ROT CW
RED/BLK	20"	TBS-5	ROT CCW
BRN	19"	P12B.1	MAIN GROUND
BRN	30"	P12B.2	HOIST UP VAL GND
BRN	30"	P12B.3	HOIST DN VAL GND
BRN	27"	P12B.4	ELEV UP VAL GND
BRN	27"	P12B.5	ELEV DWN VAL GND
BRN	28"	P12B.6	EXT OUT VAL GND
BRN	28"	P12B.7	EXT IN VAL GND
BRN	31"	P12B.8	PROP. GRND
BRN	22"	P12B.9	HORN GND

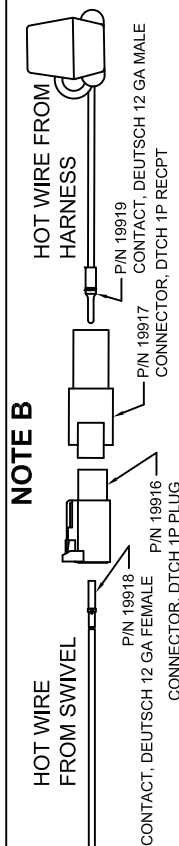
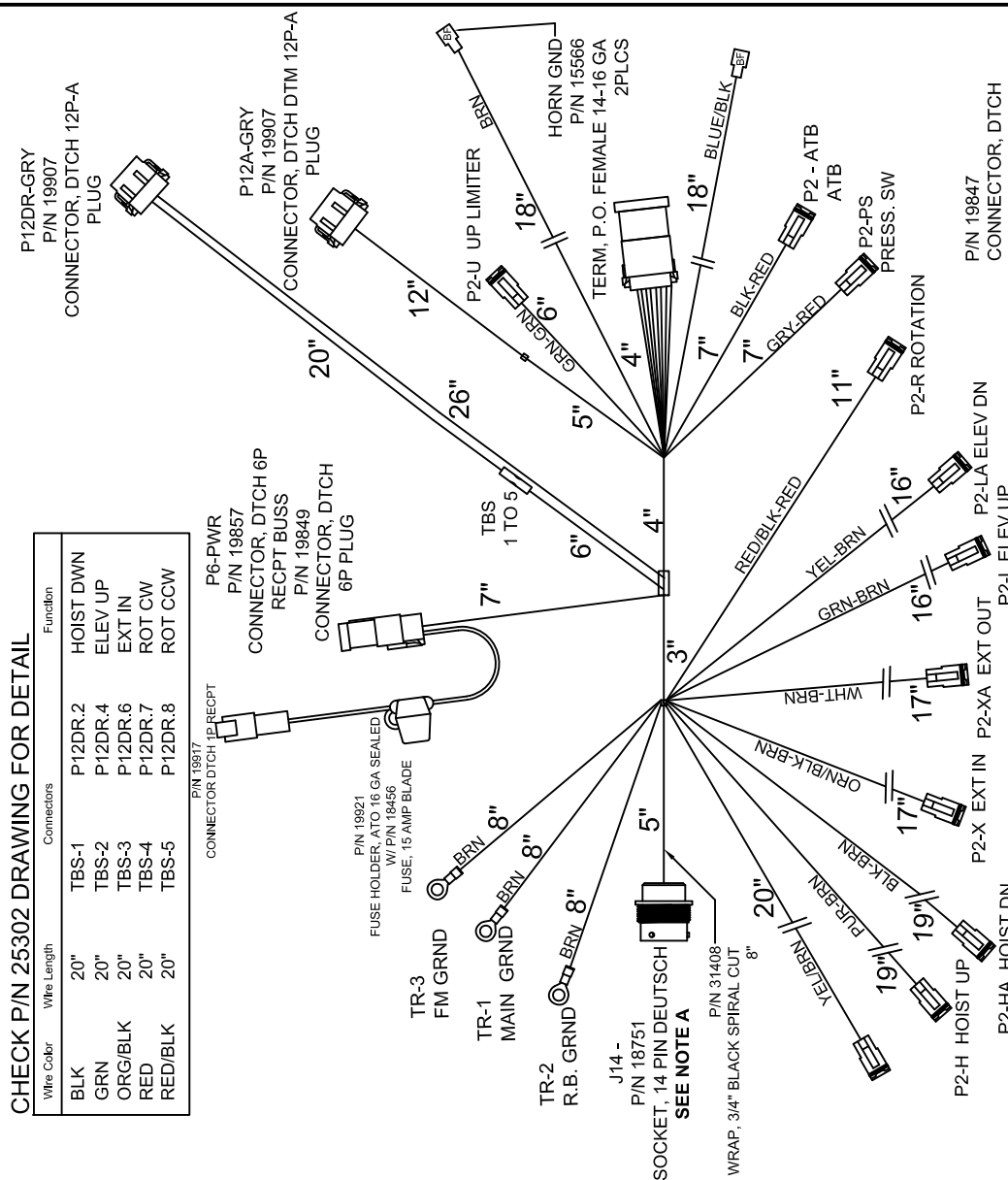

NOTE A:
FOR J-14
INSTALL 16GA. WHT PLUGS AT
PIN LOCATIONS: A & K.
& Pb.3

NOTE B:
FOR P12B
INSTALL 16GA. WHT PLUGS AT
PIN LOCATIONS: 10, 11, 12.

DRAWING NO. **25088-D**

EWH, DTCH HYD XP TO X KT-RB
E-STOP (1032/1640X)

DRAWN BY: JE
DATE: 11/21/12

Houston TX
(713)-688-5533
www.liftmoore.com

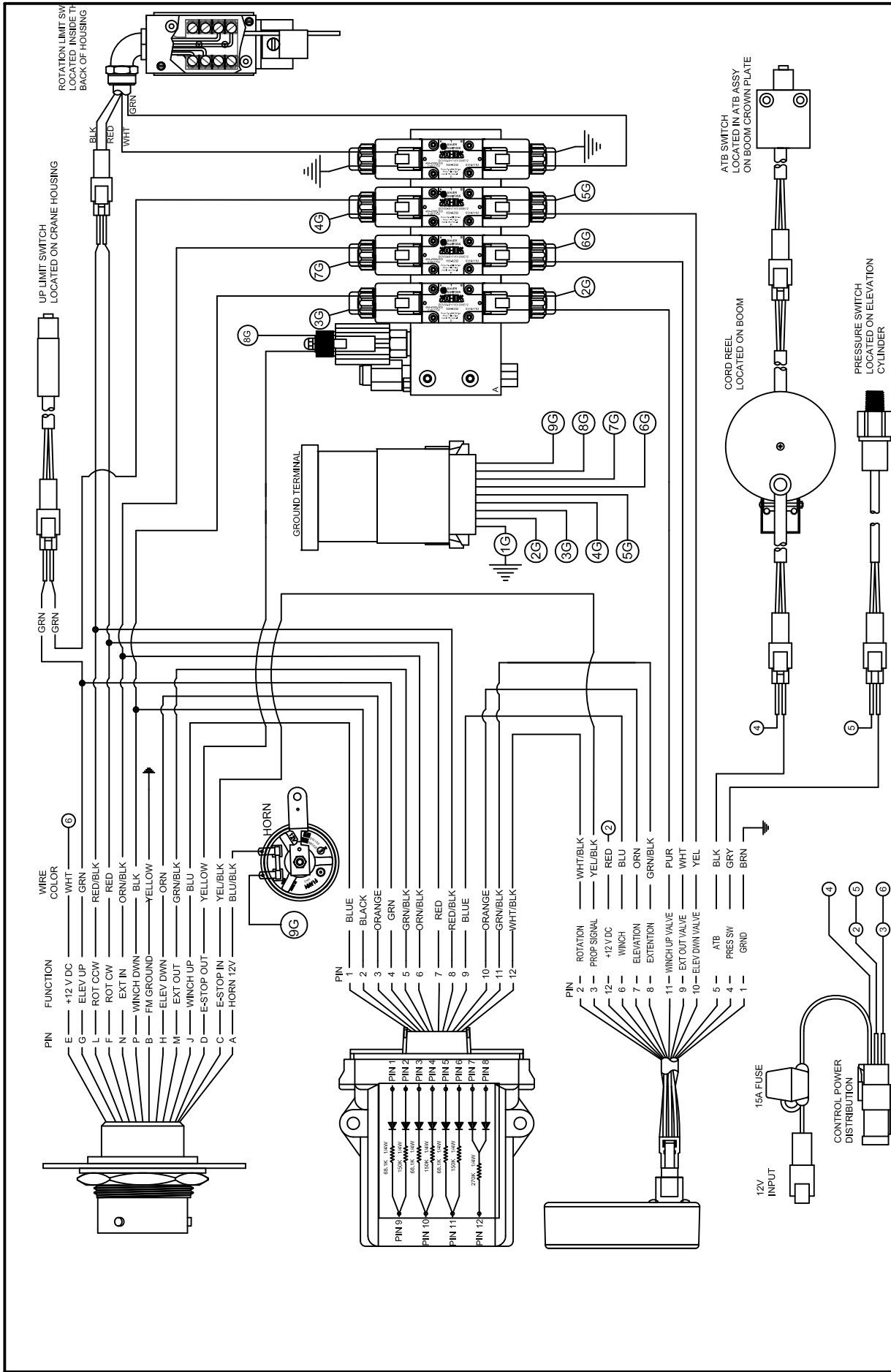

DRAWING NO. **50824-A**

SCHEM, ELEC WIRING 1640/1032
XP TO X CRANE W/HORN & SAUER DANFOSS VALVES

DRWN BY: JE
DATE: 8/20/12

Houston TX
(713)-688-5533
www.liftmoore.com



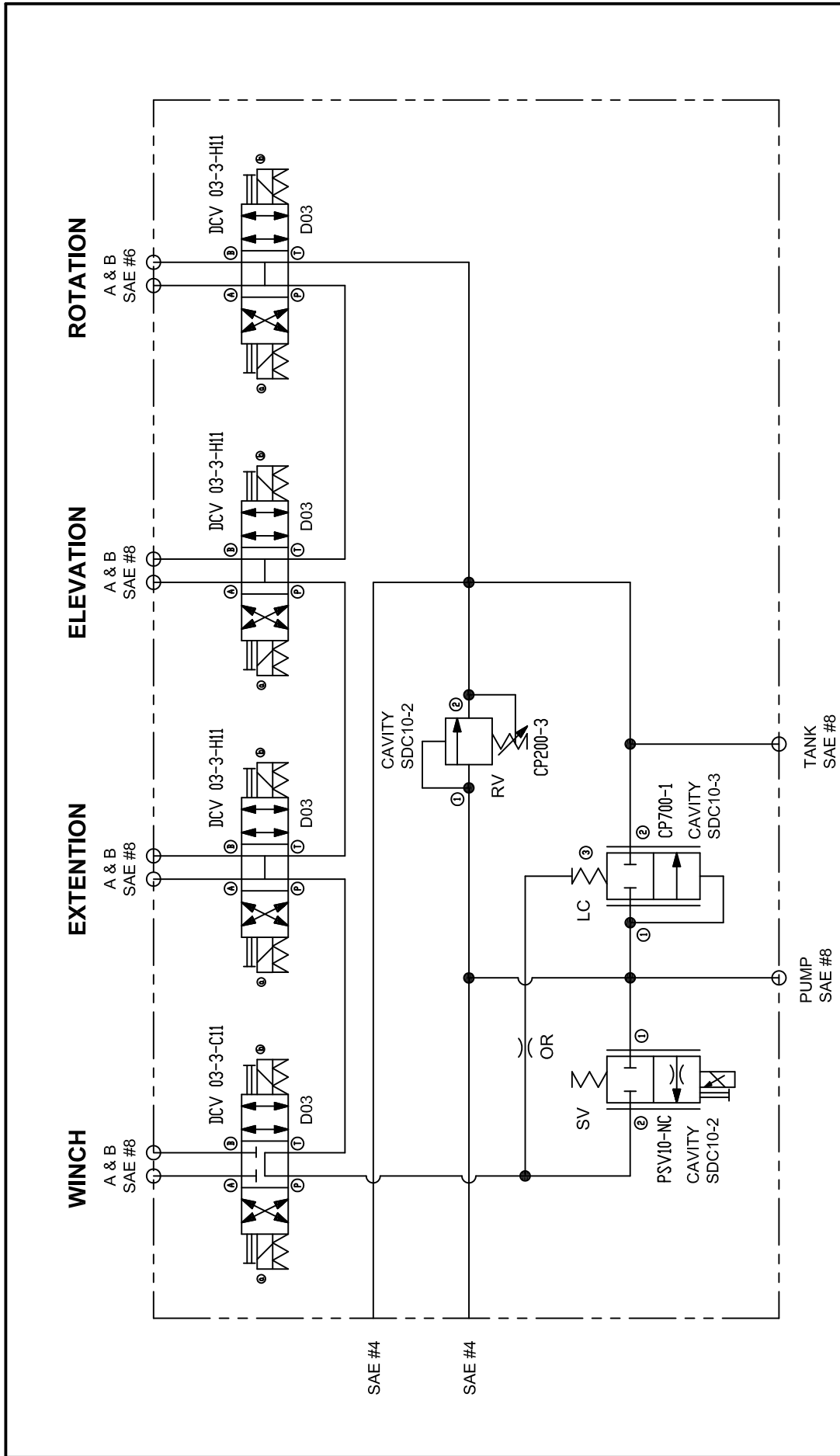

NOTE: HYDRAULIC SYSTEM RELIEF PRESSURE SET AT 2800 PSI.
 FLOW RATE INTO CRANE SHOULD BE SET AT 6 GPM.



Houston TX
 (713)-688-5533
 www.iftmoore.com

DRWN BY: JE
 DATE: 10/28/11

SCHEM, HYD PROPORTIONAL
 MANIFOLD P/N 24541 TANDEM CENTER WINCH

DRAWING NO.
 50813-A

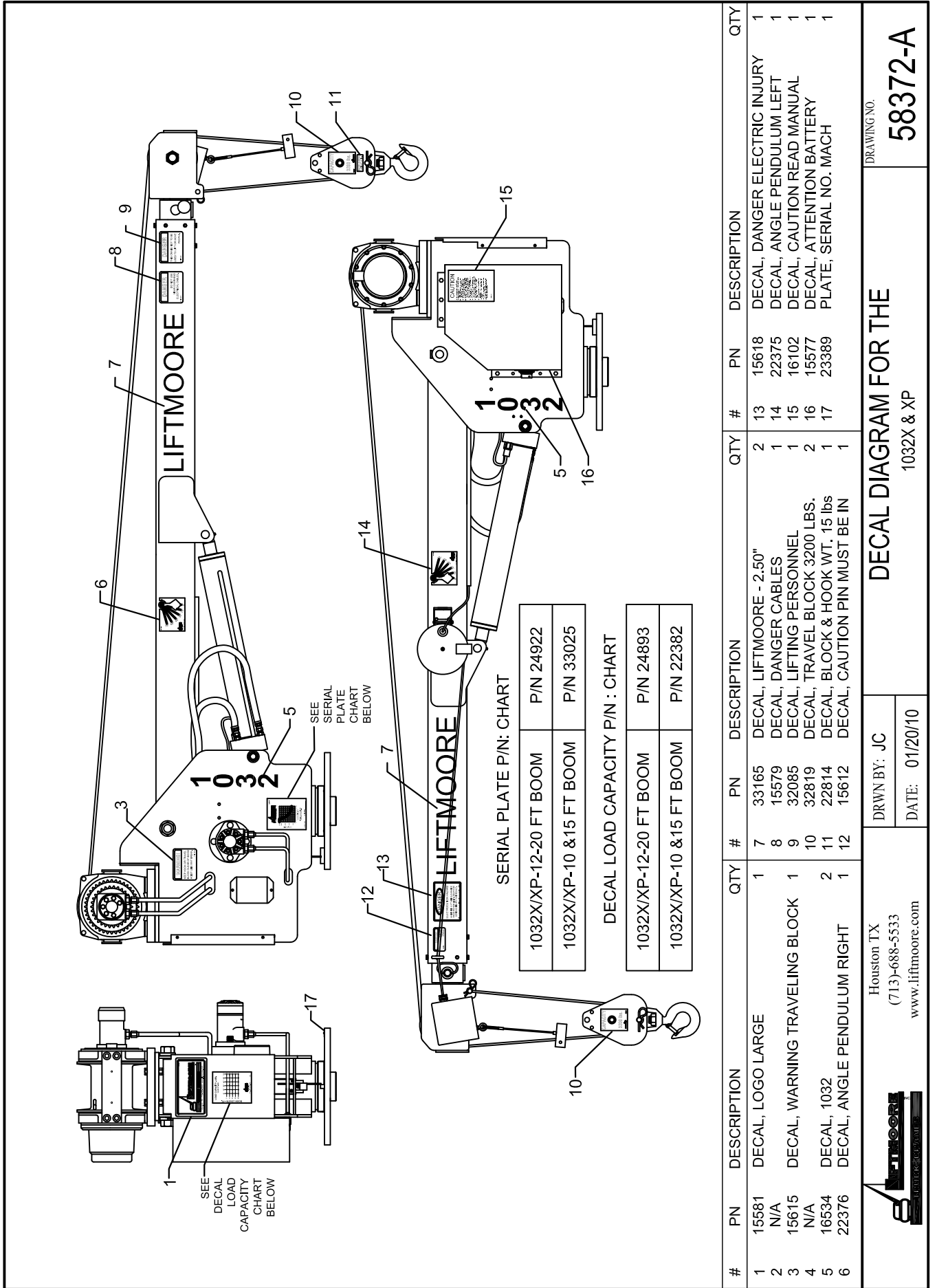

#	PN	DESCRIPTION	QTY	#	PN	DESCRIPTION	QTY	#	PN	DESCRIPTION	QTY
1	15581	DECAL, LOGO LARGE	1	7	33165	DECAL, LIFTMOORE - 2.50"	2	13	15618	DECAL, DANGER ELECTRIC INJURY	1
2	N/A			8	15579	DECAL, DANGER CABLES	1	14	22375	DECAL, ANGLE PENDULUM LEFT	1
3	15615	DECAL, WARNING TRAVELING BLOCK	1	9	32085	DECAL, LIFTING PERSONNEL	1	15	16102	DECAL, CAUTION READ MANUAL	1
4	N/A			10	32819	DECAL, TRAVEL BLOCK 3200 LBS.	2	16	15577	DECAL, ATTENTION BATTERY	1
5	16534	DECAL, 1032	2	11	22814	DECAL, BLOCK & HOOK WT. 15 lbs	1	17	23389	PLATE, SERIAL NO. MACH	1
6	22376	DECAL, ANGLE PENDULUM RIGHT	1	12	15612	DECAL, CAUTION PIN MUST BE IN	1				

SERIAL PLATE P/N: CHART	
1032X/XP-12-20 FT BOOM	P/N 24922
1032X/XP-10 & 15 FT BOOM	P/N 33025

DECAL LOAD CAPACITY P/N : CHART	
1032X/XP-12-20 FT BOOM	P/N 24893
1032X/XP-10 & 15 FT BOOM	P/N 22382



Houston TX
(713)-688-5533
www.liftmoore.com

DRWN BY: JC
DATE: 01/20/10

DECAL DIAGRAM FOR THE
1032X & XP

DRAWING NO.
58372-A

LIFTMOORE LIMITED WARRANTY

Parts and Structural

Liftmoore, Inc. warrants each LIFTMOORE crane to be free from defects in materials and workmanship for twelve (12) months from the date of delivery to the original customer. Under the terms of this warranty the crane structural components manufactured by LIFTMOORE, Inc. are warranted for thirty-six (36) months from the date of delivery to the original customer. LIFTMOORE, Inc. will repair or replace, as its sole discretion, any equipment or part that is returned f.o.b. to LIFTMOORE, Inc.'s plant at 7810 Pinemont Drive, Houston, Texas 77040, or to one of its authorized dealers, and is found by LIFTMOORE, Inc. or its authorized dealer to have been defective at the time of original delivery.

The foregoing warranty is the exclusive warranty made by LIFTMOORE, Inc. with respect to its cranes and is in lieu of all other warranties. ANY AND ALL OTHER WARRANTIES, EXPRESS OR IMPLIED, INCLUDING ANY WARRANTY OF MERCHANTABILITY OR FITNESS OF ANY CRANE FOR A PARTICULAR PURPOSE OR OPERATION, ARE HERBY EXPRESSLY DISCLAIMED.

The foregoing warranty applies only to LIFTMOORE cranes under normal use and service and does not apply in the event of damage caused by repair or alteration or damage during shipment, accident, negligence, overloading, or misuse, including operator's failure to follow any of the instructions issued with the crane.

This warranty is limited to the original purchaser and is not assignable. In order to submit a claim, the original purchaser must provide a copy of the original invoice for the crane in question within twelve (12) months following the delivery date and within 30 days from the date of repair.

The warranty applies only when the LIFTMOORE crane is used for commercial purposes and does not cover any purchase for use for personal, family or household purposes.

LIMITATION OF LIABILITY: LIFTMOORE, Inc.'s liability for any losses or damages resulting from any cause whatsoever, including LIFTMOORE, Inc.'s NEGLIGENCE or from a defective crane irrespective of whether such defects are discoverable or latent, shall in no event exceed the purchase price of the crane to which losses or damages are claimed, or at the election of LIFTMOORE, Inc., the repair or replacement of the defective crane.

In no event shall LIFTMOORE, Inc. be liable for any special, incidental, or consequential damages, including commercial losses or costs of any kind sustained by purchaser or any other person or for any damages for which purchaser may be liable to other persons by reason of any defect in any LIFTMOORE crane or any part thereof.

LIFTMOORE, Inc. reserves the right to make changes in design or construction of its cranes at any time without obligating itself to make such changes on cranes previously manufactured.

No agent, employee, or representative of LIFTMOORE, Inc. has authority to amend or modify the foregoing warranty or to bind LIFTMOORE, Inc. by any other warranty, guaranty, or assumption of liability.

In the event any provision of this warranty is for any reason held ineffective, the remaining provisions shall remain in full force and effect.

Some states do not allow limitations on how long an implied warranty lasts or the exclusion or limitation of incidental or consequential damages, so the above limitations and exclusions may not apply to you. This warranty gives you specific legal rights, and you may also have other legal rights that vary from state to state.

