

TABLE OF CONTENTS
 USERS MANUAL P/N 25997
 MANUAL, CRANE 1032XP-15 GUIDER KTG
 HORN & E-STOP, ROTATION ADJUSTER

SECTION I
GENERAL OPERATION, INSPECTION, AND MAINTENANCE

CRANE SAFETY RULES.....	F1122-B.....	1-1
INTRODUCTION	F1111-D.....	1-3
OPERATING RESTRICTIONS/ PRACTICES	F1112-E.....	1-5
INSPECTION AND MAINTENANCE.....	F1113-D	1-7
MONTHLY INSPECTION REPORT	F1123-B.....	1-9
ANNUAL INSPECTION REPORT.....	F1507-0	1-10
STANDARD HAND SIGNAL FOR CRANE OPERATION	F2409-0	1-13

SECTION II
CRANE SYSTEMS AND TROUBLESHOOTING

KTG CONTROL SYSTEM.....	F1231-B	2-1
KTG ENGINE RECIEVER INSTALL(OPTIONAL)	F1214-C	2-3
SAFETY SYSTEM.....	F1769-0	2-4
PROPORTIONAL HYDRAULIC SYSTEM.....	F1116-D	2-5
BASIC TROUBLESHOOTING CHART	F1117-G	2-7
GENERAL TROUBLESHOOTING.....	F1127-C.....	2-8
TROUBLESHOOTING SAFETY SYSTEM	F1447-B	2-11
DEUTSCH CONNECT & PINS	F2435-0	2-37

SECTION III
CRANE SPECIFICATIONS

LIFTING CAPACITIES	F1642-B	3-1
POWER FUNCTIONS AND SPEEDS.....	F1642-B	3-1
BOLT AND LUBRICATION SPECS	F1642-B	3-2
CRANE LUBRICATION POINTS.....	F1642-B	3-3

SECTION IV
PARTS

BOX PARTS LIST.....	F2120-B	4-1
CRANE ASSEMBLY	DWG.25996-E.....	4-2
FM CONTROL RECIEVER	DWG.24572-A	4-3
ENGINE CONTOL RECIEVER (OPTIONAL).....	DWG.24455-0	4-4
TRAVEL BLOCK ASSEMBLY	DWG.27343-A	4-5
ANTI-TWO BLOCK ASSEMBLY.....	DWG.22908-B.....	4-6
BOOM-BODY ASSEMBLY	DWG.27374-0	4-7
ELEVATION CYLINDER ASSEMBLY	DWG.21603-A	4-8
BODY ASSEMBLY.....	DWG.25994-D	4-9
MANIFOLD ASSEMBLY	DWG.25203-D	4-10
MANIFOLD PRE-ASSEMBLY	DWG.24822-C.....	4-11
BASE-HOUSING ASSEMBLY.....	DWG.25993-C.....	4-12



TABLE OF CONTENTS
USERS MANUAL P/N 25997
MANUAL, CRANE 1032XP-15 GUIDER KTG
HORN & E-STOP, ROTATION ADJUSTER

ROTATION COMPONENTS	DWG.50570-B.....	4-13
BOOM ASSEMBLY – 15 FT	DWG.27372-A	4-14
BOOM INNER ASSEMBLY – 15 FT	DWG.23441-0	4-15
WINCH.....	DWG.25048-A	4-16
ELECTRICAL WIRING HARNESS.....	DWG.25206-C.....	4-17
ELECTRICAL SCHEMATIC DTCH.....	DWG.50827-0	4-18
HYDRAULIC SCHEMATIC	DWG.50813-A	4-19
DECAL DIAGRAM	DWG.58372-A	4-20
WARRANTY	F1442-A	



CRANE SAFETY RULES

CAUTION!

1. READ AND UNDERSTAND OPERATOR'S MANUAL.
2. INSPECT VEHICLE AND CRANE, INCLUDING ITS OPERATION BEFORE DAILY USE.
3. USE THIS EQUIPMENT ONLY ON SOLID LEVEL GROUND WITH OUTRIGGERS OR JACKSTANDS PROPERLY SET.
4. BEFORE OPERATING THE CRANE REFER TO MAXIMUM LOAD CHART ON CRANE FOR OPERATING LOAD LIMITS.
5. BE SURE LOAD BEING LIFTED IS WITHIN SAFE WINCH CAPACITY AS WELL AS SAFE CRANE CAPACITY. MULTI-PART LINE OPERATION IS REQUIRED WHEN SINGLE LINE LOAD CAPACITY OF WINCH IS EXCEEDED.
6. DO NOT OPERATE, WALK, OR STAND UNDER THE BOOM OR ANY SUSPENDED LOAD.
7. ALWAYS PAY OUT LOAD LINE BEFORE EXTENDING BOOM. WIRE ROPE DAMAGE AND / OR BREAKAGE MAY OCCUR.
8. BOOM MUST BE IN ITS REST BEFORE MOVING VEHICLE.
9. BOOM TIP MUST BE DIRECTLY OVER THE LOAD BEFORE ANY LIFTING IS STARTED. DO NOT DRAG LOADS WITH THIS CRANE.
10. MAINTAIN THIS CRANE AS REQUIRED IN THE OWNER'S MANUAL.
11. DO NOT ALLOW PERSONNEL TO RIDE ON THE LOAD LINE, LOAD, OR BOOM OF THIS CRANE.
12. IT IS UNLAWFUL TO OPERATE THIS EQUIPMENT WITHIN TEN FEET OF HIGH VOLTAGE LINE



THIS PAGE INTENTIONALLY LEFT BLANK



HOUSTON, TEXAS
FAX: (800) 824-5559 (USA & Canada)
FAX: (713) 688-6324
PHONE: (713) 688-5533
www.liftmoore.com

INTRODUCTION

This crane is a powerful machine designed to lift and move heavy loads. There are many hazards associated with these operations. Liftmoore has designed this crane to be as safe as possible but -

IT IS THE OPERATOR'S RESPONSIBILITY TO PREVENT ACCIDENTS!

This takes pre-planning, attention, and knowledge of basic principles and rules. Even if you have used similar cranes, reading this manual in its entirety will help prevent damage, injury, or even loss of life; benefits well worth the short amount of time it takes to read these pages.

REGULATORY AUTHORITY

Use of this crane is governed by OSHA 29 CFR 1910.180 and may be governed by other federal, state, or local regulations.

IT IS THE OPERATOR'S RESPONSIBILITY TO UNDERSTAND AND COMPLY WITH ALL APPLICABLE REGULATIONS GOVERNING THE OPERATION, INSPECTION, AND MAINTENANCE OF THIS CRANE.

Personnel should be trained, tested, and certified, as recommended by OSHA and ANSI standards, before operating this crane.

USING THIS MANUAL

This manual assumes that the crane is mounted on a typical service body type or similar truck, which is powered by the vehicle electrical or hydraulic system, and is controlled by either the standard pendant control or FM radio control sold by Liftmoore, Inc.

This manual is supplied to provide basic guidelines for the safe use, routine maintenance, and general inspections of this crane.

This manual is supplied to provide basic guidelines for the safe use, routine maintenance, and general inspections of this crane.

Laws, regulations, standards, or policies may be more restrictive than this manual. If a conflict exists for any limit or condition, the safest or most prohibitive shall be used. Under no circumstances shall the load, moment, or stability ratings be exceeded.

Pay particular attention to the following:

WARNING! – Draws attention to hazards, conditions, or procedures that if not observed could result in injury or death.

CAUTION! – Draws attention to hazards, conditions, or procedures that if not observed could result in damage to the crane, load, or other equipment. Equipment failure could in turn lead to injury or death.

NOTE! – Draws attention to conditions or procedures that are essential to emphasize.

For questions, interpretations, or to report errors, please contact Liftmoore, Inc, Engineering Dept.



OPERATING PRACTICES

OPERATING RESTRICTIONS

DUTY CYCLE

For Electric Cranes the duty cycle time should be limited to 10%. This is limited by heat buildup in the motors and declining charge in the batteries. (Installing extra batteries near the crane helps keep the voltage at maximum.)

PERSONNEL

LIFTING OR MOVING OF PERSONNEL IS STRICTLY PROHIBITED! This crane was neither designed nor intended to lift personnel. Under no circumstances should anyone be allowed to ride on the crane, line, or load. All non-essential personnel must be kept away when using the crane. The load must never be moved over people, nor must anyone be allowed to pass or stand under a suspended load.

ELECTRICAL LINES

Consult ANSI B30.5 for operating procedures, minimum safe distances, and prohibited zones when working around electrical lines or poles.

When operating near electrical power lines, the crane must be positioned so that the distance from the crane to the lines or poles is equal to or greater than the length of the fully extended boom plus the minimum safe distance required.

All parts of the crane, line, and load must be kept a minimum safe distance from electrical power lines and poles. This distance is 10 feet for electrical lines carrying 50kV or less.

UNDER NO CIRCUMSTANCES SHOULD A CRANE BE OPERATED UNDER ELECTRICAL POWER LINES.

SETUP

POSITION The vehicle must be positioned so that the load is kept as close to the crane base as possible to reduce the moment on the crane. Consideration must be given to starting and ending position as well as firmness and slope of the ground and any obstructions.

OUTRIGGERS The outriggers or jackstands must be firmly set and the vehicle as level as possible. This will reduce the stresses on the rotation drive and keep the load off the vehicle's suspension. Keep in mind that the weight on the vehicle will shift as the crane and load is rotated.

MANUAL BOOM EXTENSION If the manual extension part of the boom is needed, it must be extended and the boom pin placed in the required position. Insert the pin and replace the pin's hairpin keeper before attempting to lift any load.

LOAD LIMIT The operator must understand the crane load chart. The operator must ensure that the load is within the load limits over the entire range which it will be moved. Be sure to include the weight of any lifting devices including the travel block.

The load limit chart is attached to the side of the crane to aid the operator.

The boom angle indicator and chart aids the operator in determining the load capacity at various boom angles and extensions. It also gives the load limit at that configuration.

STABILITY A stability chart must be posted near the crane. The operator must understand the stability chart. The crane may be de-rated over some areas of its operating radius.



TRAVEL BLOCK The operator must determine if the load is within the single line compatibility of the winch or if a multi-part line configuration is needed.

REEVING Ensure the proper routing of the rope through the sheaves and travel block. The rope must lie in the sheave groove and must not rub against any metal objects.

Ensure the rope is correctly wound on the winch drum. The crane assembly drawing will indicate if the rope must be wound over the top or bottom of the drum. The rope must never contact any part of the winch mounting.

WARNING!

If the winch winding direction is reversed the brake will not work and the load will fall.

ATTACHING THE LOAD

POSITION The boom tip must be moved over the load before lifting so that it will be lifted straight up.

CAUTION!

Never drag a load with the crane. Dragging a load puts very high stresses on the crane for which it was not designed.

ROPE Check the rope condition to ensure it is not frayed or damaged. Ensure that the rope is not kinked and that it does not contact any sharp edges or make any sharp bends.

If using double line configuration, ensure that the lines are not twisted.

CAUTION!

Never wrap the hoist rope around the load! Serious damage to the rope WILL occur.

HOOK Always make sure the load is applied to the throat of the hook. Never use a bent hook.

CAUTION!

Always lift with the throat of the hook. Never lift with the load applied to the tip of the hook. Doing so will bend the hook.

SLINGS If the load does not have a lifting eye, use a nylon, chain, or other type of sling designed for lifting and rated for loads greater than that being lifted.

BALANCE Ensure the load will be secure and balanced when lifted. Ensure that the load cannot shift in the sling and that the sling cannot slide across the hook should the load become unbalanced.

LIFTING THE LOAD

Before lifting, ensure that the load is free from all mountings and is no way attached or stuck to anything.

Ensure that at least five full wraps remain on the winch drum at all times.

Test the winch brake by lifting the load a few inches and ensuring that it does not slip.



HOLDING THE LOAD

The operator must keep the load in sight at all times once it is lifted.

The operator must never leave the controls once the load is lifted.

The operator must ensure that no one is allowed to pass or stand under a suspended load.

CAUTION!

Never move the vehicle with a suspended load. Doing so will put dynamic loads on the crane for which it was not designed.

MOVING THE LOAD

Before moving the load, make sure the path is free of any obstructions or people.

Avoid sudden accelerations or stops. Speeds must be kept to a minimum, especially rotation, to keep the load from swinging.

Avoid sudden reversing of direction. Do not reverse direction while the load is still moving.

Make sure that no part of the crane, boom, or load makes contact with any obstruction or comes within a minimum of ten feet from any electrical line.

TRANSIT

While in transit, the crane must be stowed, preferably in a boom rest. The crane must be prevented from rotating and the hook prevented from swinging.



INSPECTION AND MAINTENANCE

OSHA and ANSI require frequent and periodic inspections. Records of these inspections must be kept readily available. Liftmoore requires periodic maintenance to ensure proper operation and prolonged life of the crane.

INSPECTION

DAILY INSPECTION

OSHA 29CFR 1910.180 (d)(2)(i) requires the following be checked daily prior to use:

- All control mechanisms for maladjustment interfering with proper operation as well as for excessive wear of components and contamination by lubricants or other foreign matter.
- All safety devices for malfunction. This should include the anti-two block and pressure switch.
- Deterioration or leakage in air or hydraulic systems.
- Crane hooks with deformations or cracks. For hooks with cracks or having more than 15 percent in excess of normal throat opening or more than 10 deg. twist from the plane of the unbent hook.
- Electrical apparatus for malfunctioning, signs of excessive deterioration, dirt, and moisture accumulation. This should include the battery terminals, master disconnect switch, electrical swivel
- The wire rope shall be replaced if any of the following conditions are noted:

- Kinking, crushing, bird-caging, or other damage
- Reductions from nominal diameter of more than one-sixty-fourth inch for diameters up to and including five-sixteenths inch, one-thirty-second inch for diameters three-eighths inch to and including one-half inch.
- Thimble is not in place or is damaged
- Any evidence of heat damage
- Six or more randomly distributed broken wires in 1 lay
- Three or more broken wires in 1 strand in 1 lay

MONTHLY INSPECTION

A thorough inspection of all ropes in use shall be made at least once a month and a certification record which includes the date of inspection, the signature of the person who performed the inspection and an identifier for the ropes shall be prepared and kept on file where readily available. All inspections shall be performed by an appointed or authorized person. Any deterioration, resulting in appreciable loss of original strength shall be carefully observed and determination made as to whether further use of the rope would constitute a safety hazard. Some of the conditions that could result in an appreciable loss of strength are the following:

- Reduction of rope diameter below nominal diameter due to loss of core support, internal or external corrosion, or wear of outside wires.
- A number of broken outside wires and the degree of distribution of concentration of such broken wires.



- Worn outside wires.
- Corroded or broken wires at end connections.
- Corroded, cracked, bent, worn, or improperly applied end connections.
- Severe kinking, crushing, cutting, or unstranding.

PERIODIC INSPECTION

An Annual Inspection Form is included in this manual. OSHA 29CFR 1910.180 (d)(2)ii) requires periodic inspections of this crane. Liftmoore recommends an annual inspection using the included form.

MAINTENANCE PRECAUTIONS

The crane should be maintained monthly for safety reasons and to reduce stress on the crane.

WARNING!

Never perform any maintenance while the crane has any type of load on it. Use the manual operation procedure to lower the load if necessary.

WARNING!

Hydraulic cylinders may have high pressure stored in them even after hydraulic power is removed.

The counterbalance and pilot operated check valve in the cylinder will always hold some pressure in the cylinder. Slightly extending the cylinder then retracting a small amount will relieve most of the pressure in the cylinder. **DO NOT DEADHEAD THE CYLINDER!** This will store the maximum amount of pressure in the cylinder. Care should be taken when either valve is removed from the cylinder as some pressure will still remain.

After any maintenance has been performed the crane shall not be operated until all guards have been reinstalled, all safety

devices reactivated, and maintenance equipment removed.

LUBRICATION Refer to the crane specification section for the periodic maintenance schedule and type of lubrication required.

BOLTS Bolts may loosen over time due to vibration; therefore they should be checked periodically. If bolts need to be replaced, make sure they are replaced with bolts of equal or greater strength. Check the periodic maintenance schedule (Crane Specification Section) for bolt specification and torque.

NOTE!

Sheave and boom and cylinder pivot bolts are not standard bolts. The shank and thread length of these bolts have been modified so that they do not pivot on the threads. Consult the parts section of this manual for part numbers of these bolts.

OTHER MAINTENANCE

Refer to parts drawings for any specific maintenance or adjustment procedures such as hydraulic winch brake, rotation drive gear set adjustment, Ect.



MONTHLY INSPECTION REPORT

Crane Model No. _____ **Serial Number** _____

Are Boom Hitch Pins and Keepers in place?	Yes _____	No _____
Wire Line Hook with Safety Latch Working?	Yes _____	No _____
Is Hook OK, (Not bent)?	Yes _____	No _____
Is Thimble on Wire Rope OK?	Yes _____	No _____
Is Traveling Block in use?	Yes _____	No _____
Is Wire Rope OK, not kinked or frayed?	Yes _____	No _____
Are all Boom Sections straight?	Yes _____	No _____
Are Sheave Bolts in place and tight?	Yes _____	No _____
Do all Sheaves rotate easily?	Yes _____	No _____
Are Mounting Bolts tight?	Yes _____	No _____
Is Anti Two-Block functioning properly?	Yes _____	No _____
Is Boom Angle Indicator in place and functioning and is Chart legible?	Yes _____	No _____
Are Cylinder Mounting Bolts secure?	Yes _____	No _____
Are Winch Mounting Bolts tight?	Yes _____	No _____
When stopped does winch drift less than 1.0 Inches?	Yes _____	No _____
Is Load Chart in place and easily read?	Yes _____	No _____
Are functions on Pendant operating correctly?	Yes _____	No _____
Is Hydraulic Reservoir full?	Yes _____	No _____
Is Outrigger straight and functioning?	Yes _____	No _____

Any items checked 'No' must be repaired before using this crane.



ANNUAL CRANE CERTIFICATION (29CFR1910.180)

OWNER _____

MODEL NUMBER _____ SERIAL NUMBER _____

DATE _____

Check the following:

___ Crane Mounting Bolts (Torque)

___ Winch mounting Bolts (Torque)

___ Boom mounting bolts

___ Cylinder mounting bolts

___ Cracks on boom (Check when extended)

___ Extension Pads not worn excessively

___ Cracks on housing

___ Weld cracks on boom

___ Weld cracks on housing

___ Boom swing approximately one inch or less at boom tip when retracted

___ Hydraulic leaks

___ Hoses not chafed or cracked

Sheaves not cracked

___ Boom Tip

___ Traveling Block

___ Sheaves not worn excessively

___ Boom Tip

___ Traveling Block

___ Sheaves rotate freely

___ Boom Tip

___ Traveling Block

___ *Load Chart in place and legible*

___ *Boom angle chart in place and legible*

___ *Labels in place (See manufacturer's chart)*

___ *Crane Hook Throat Opening within 15% of standard*

___ *Crane Hook not bent more than 10 degrees from plane*

___ *Hook safety latch operating properly*

___ *Booms pin(s) and Keeper(s) in place (Manual Extension Section)*

___ *Wire Rope removed if the following occurs:*

Six randomly distributed broken wires in one lay or three broken wires in one strand in one lay.

Wear of one-third the original diameter of outside individual wires.

Kinking, crushing, bird-caging or any other damage.

Evidence of heat damage.

Reduction from nominal diameter of more than one sixty-fourth inch for diameters to five-sixteenths diameter and one-thirty-second inch for diameters three-eighths to one-half inch.

___ *Wire Line installed as manufacturer requires.*

___ *Protective covers in place*

___ *Grease crane as required*

Check fluid level

___ *Winch*

___ *Gearbox*

___ *Reservoir*

Control system for proper operation

___ *Winch Up and Down*

___ *Boom Up and Down*

___ *Boom In and Out*

___ *Rotation CW and CCW*

Anti Two-Block (Required on Power Extendible Cranes) interrupts:

___ *Boom Down*

___ *Boom Out*

___ *Winch Up*

___ *Boom Up stopped by Up Limit Switch*

___ *Outrigger or jackstand operable*

___ *Outrigger crushing decal in place*

___ *Outrigger and Jackstand operates properly*

___ *Boom rest in place and used*

___ *Load Sensor trips when overloaded*

___ *Winch Down does not overrun when stopped*

___ *Crane stability chart in place and visible.*

I certify that I have performed the above tests and that any deficiencies were corrected and now comply as above.

Signed _____



Print Name _____

Company _____

Address _____

City _____ *State* _____

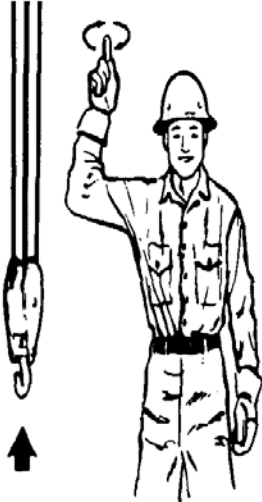
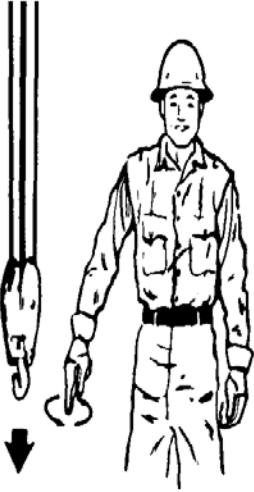
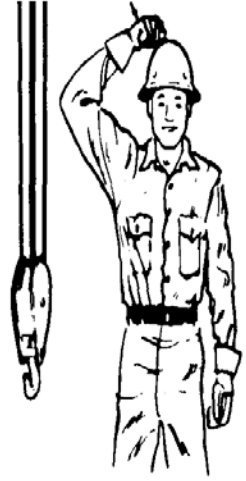
STANDARD HAND SIGNALS FOR CONTROLLING CRANE OPERATIONS

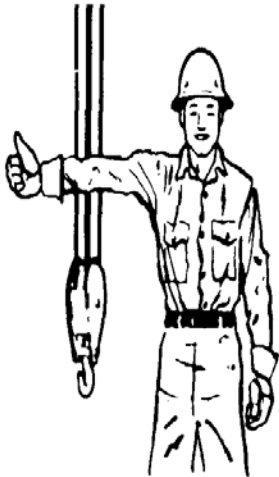
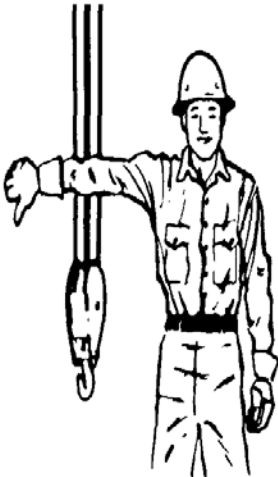
 <p>HOIST. With forearm vertical, forefinger pointing up, move hand in small horizontal circle.</p>	 <p>LOWER. With arm extended downward, forefinger pointing down, move hand in small horizontal circle.</p>	 <p>USE MAIN HOIST. Tap fist on head; then use regular signals.</p>
 <p>USE WHIPLINE (Auxiliary Hoist). Tap elbow with one hand; then use regular signals.</p>	 <p>RAISE BOOM. Arm extended, fingers closed, thumb pointing upward.</p>	 <p>LOWER BOOM. Arm extended, fingers closed, thumb pointing downward.</p>

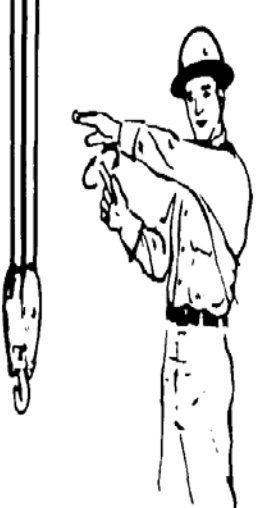
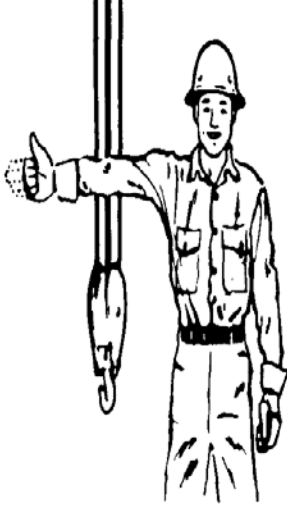
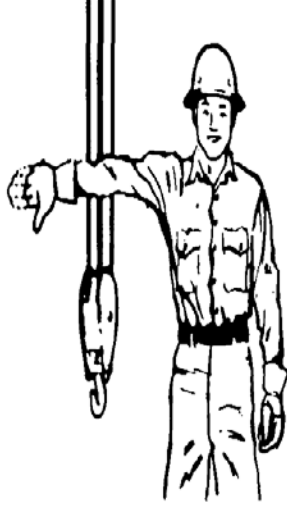
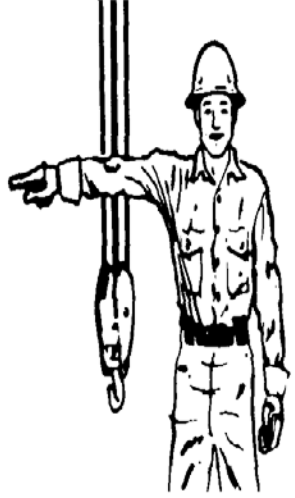
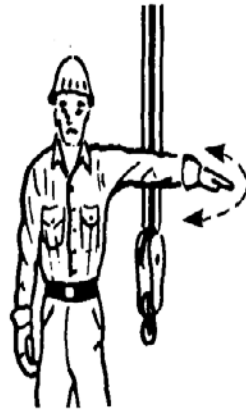
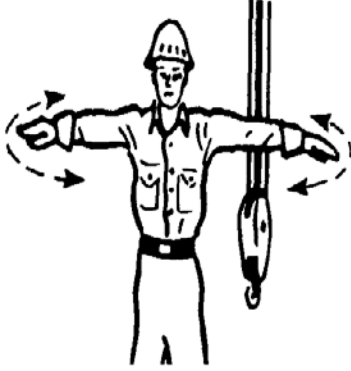
 <p>MOVE SLOWLY. Use one hand to give any motion signal and place other hand motionless in front of hand giving the motion signal. (Hoist slowly shown as example.)</p>	 <p>RAISE THE BOOM AND LOWER THE LOAD. With arm extended, thumb pointing up, flex fingers in and out as long as load movement is desired.</p>	 <p>LOWER THE BOOM AND RAISE THE LOAD. With arm extended, thumb pointing down, flex fingers in and out as long as load movement is desired.</p>
 <p>SWING. Arm extended, point with finger in direction of swing of boom.</p>	 <p>STOP. Arm extended, palm down, move arm back and forth horizontally.</p>	 <p>EMERGENCY STOP. Both arms extended, palms down, move arms back and forth horizontally.</p>

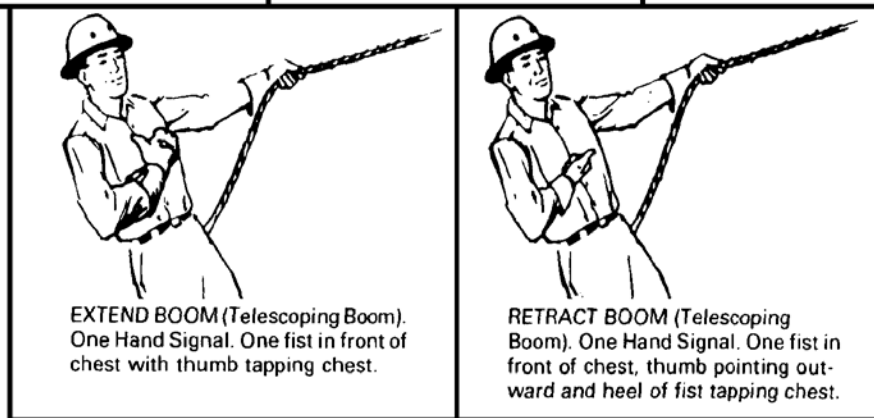
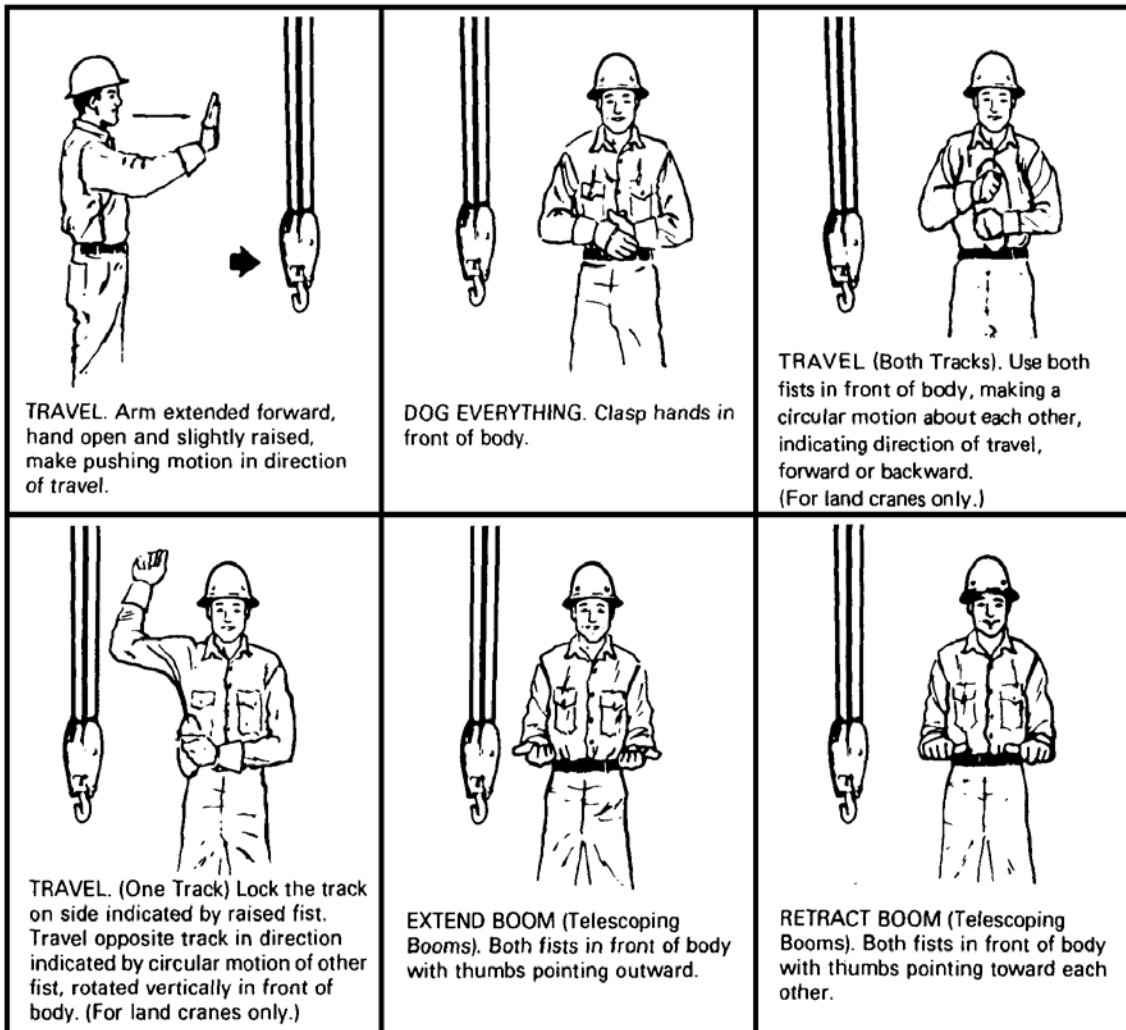

THIS PAGE INTENTIONALLY LEFT BLANK



HOUSTON, TEXAS
FAX: (800) 824-6669 (USA & Canada)
FAX: (713) 688-6324
PHONE: (713) 688-5533
www.liftmoore.com

FM CONTROL SYSTEM

K2FM - 2ND Generation KTFM (Hall Effect Trigger)

The Liftmoore FM control system Model KTFM is a microprocessor-based radio/CAN remote control system. It allows the operator to control the crane using FM radio signals or the digital Control Area Network (CAN) protocol.

The standard system consists of a transmitter, crane receiver/control system, CAN cable, and a battery charger. For systems with engine control an additional engine control receiver is included.

RECEIVER

The crane receiver is a self-contained control system. It contains the FM receiver, limiting system, and proportional valve driver (for proportional control cranes only). It receives power and safety circuit inputs (ATB and load sensor) from the crane. User inputs are received from the transmitter by FM radio signals or through the CAN cable. A green signal reception LED (light) and a red error code LED are provided for user diagnostics.

Error codes are indicated by counting the flashes of the red error code LED. The number of flashes represents the error code listed on the front of the receiver.

NOTE!

Error Code 1, which appears as continual, steady blinking, will remain active until a signal is received.

TRANSMITTER

The transmitter is a hand held unit which sends user input to the receiver by FM radio signals or by the CAN cable. Its features consist of an on/off push button switch, double acting momentary contact switches for each function, a 4 pin connector for attaching the CAN/charging cable, low battery light, and a transmit light.

For proportional control cranes a trigger is provided for speed control.

A Start/Stop toggle switch and an Engine High/Auxiliary toggle switch are provided for engine control. They work with the **optional** engine control receiver. If the crane was not ordered with this feature, it may be added. Contact your distributor or Liftmoore for more information.

The green transmit light will flash any time a user input is being transmitted.

BATTERY AND CHARGING

The transmitter is powered by a 9.6V Ni-Cad battery or from the crane power source when attached to the CAN cable. Connecting the transmitter to the CAN cable also charges the battery. To conserve battery power the transmitter will turn itself off if idle for 1 hour.

When battery voltage drops below 9V the battery light will blink once every 30 seconds. As the battery voltage continues to drop the light will blink faster.

Ni-Cad batteries can develop a "memory" and should not be left on the charger for long periods of time. Periodically they should be allowed to discharge fully then given a full charge. A full charge is achieved in 8 hours.

COMPONENT REPLACEMENT

Each transmitter is encoded with a digital ID that is programmed to its specific receiver. The receiver then only accepts signals from that transmitter so multiple cranes may be operated in the same vicinity without interference. If either component needs to be replaced, the receiver must be programmed to accept the new transmitter ID. This is easily done with a temporary wiring harness. Contact Liftmoore for more information.



NORMAL OPERATION

Turn on power to the crane and ensure the receiver is also receiving power.

Turn on the transmitter by holding the power button for at least a half of a second or until the power and transmit lights stop flashing. Note that when the flashing stops the green light will be on and remain on until the button is released.

Select a function and press the toggle switch in the desired direction as indicated on the label.

If the crane is a proportional control type, then SLOWLY squeeze the trigger after the function switch is activated.

NOTE!

If the trigger is pulled before a function switch is activated Error Code 7 will be active and the crane will not function. The trigger finger should remain off of the trigger until after a function is selected.

SPECIAL OPERATION

CHANNEL LOCKING

If excessive interference is experienced, the transmitter can be set to use only one frequency.

To lock a channel, turn off the transmitter power then hold HOIST DOWN and ROTATION CCW while turning the power on.

The Low Battery LED will blink several times. The number of flashes will indicate the channel number that it is locked on.

Channel Lock will remain active until the transmitter is turned off.

POWER ADJUSTMENT

The transmitter can be set at one of 4 power levels. Increasing the power will increase the range and reliability, but will decrease battery life.

To change the power setting activate and hold ENGINE SPEED and BOOM UP for 3 seconds. The red (Low Battery) LED will flash from 1 to 4 times to indicate the power level.

The power level will remain set until changed by the user, even if the transmitter is turned off.

ENGINE CONTROL (OPTIONAL)

If the FM system was ordered with the engine control option an engine control receiver will be included, if not it may be ordered separately. Contact your distributor or Liftmoore for more information.

TRANSMITTER

Both engine control switches are double acting momentary toggle switches. One controls start and stop and the other controls high idle and an auxiliary function.

RECEIVER

Both the start and stop output signals are momentary, i.e. the output signal is on only when the switch is held.

The auxiliary output is maintained. When the switch is pressed the signal toggles, i.e. the first time the switch is activated the signal turns on, the second time it is activated the signal turns off.

The high idle signal can be set up as either maintained or momentary as needed. If a positive voltage is supplied to pin 5 then the output is momentary, otherwise the output is maintained.



OPTIONAL ENGINE CONTROL RECEIVER INSTALLATION

The engine control functions allow the user to start and stop the engine and also advance the idle, all from the crane remote pendant control.

The following instructions provide a general guideline for installing and wiring the receiver. Since engine controls vary from manufacture to manufacturer and even from year to year, it is impossible for Liftmoore to maintain specific information on your vehicle. You will have to contact the vehicle and/or engine manufacturer (contact information is provided below). Also, many new vehicles have a provisions for remote engine control built into the ECU, but these functions must be activated and/or programmed by a dealer or authorized service center.

MOUNTING THE RECEIVER

The receiver should be mounted vertically with the antenna up. For best reception, it should be mounted in cab in line of site of operator. Since interfacing connections will generally be inside the cab, a good mounting place is the inside, back the cab with the antenna visible through the back glass. The receiver can be mounted outside of the cab, however it should NOT be mounted inside the engine compartment because of interference generated by the engine.

ENGINE START

Engine start is accomplished by splicing the brown wire on the engine receiver control harness with the ECU start circuit.

WARNING!

Engine start may bypass some manufactures safety functions such as clutch or neutral interlock. It is the installer's responsibility to ensure safe and proper installation.

ENGINE STOP

If the ECU is not equipped with a remote engine kill circuit then a normally closed relay must be installed in the ECU power or engine run circuit. The gray wire on the engine control receiver harness is then connected to the solenoid coil. Activating the circuit will open the solenoid, killing the engine.

NOTE!

It is advisable to include a small jumper wire that can be installed to bypass the solenoid should it fail, otherwise the engine would not run.

ADVANCED IDLE

Many new diesel engines have an advanced idle control circuit built into to the ECU. Some automatically advance the idle when the PTO is activated. This feature may have to be activated and/or programmed by the dealer.

NOTE!

Some engines also require activating a PTO circuit to prevent "Service Engine Soon" or other erroneous errors during PTO operation.

For gas engines or engines without this feature, an after-market throttle advance will have to be purchased separately.

CONTACT INFORMATION

Your truck or engine dealer should be able to provide you with further assistance. Also check the manufacturer's body builder manual (some provided online). Before calling, please have your vehicles make, model, year, engine and transmission size and manufacturer, and VIN if available.

Ford Body Builders Advisory Service	1.877.840.4338
GM Upfitter Integration	1.800.875.4742
Peterbilt	1.940.591.4000
Caterpillar	1.800.847.4986
Cummins	1.800.343.7357
Dodge	

www.fleet.ford.com/truckbbas
www.gmupfitter.com

Rammbg@chrysler.com

HOUSTON, TEXAS
 FAX: (800) 824-5559 (USA & Canada)
 FAX: (713) 688-6324
 PHONE: (713) 688-5533
www.liftmoore.com

SAFETY SYSTEM

The safety system is designed to help prevent damage to the crane that would be caused by overload or two-blocking. The system consists of a load sensor, anti-two block device (optional on smaller, electric cranes), and limiting system control board.

When the applicable switch detects an overloading or two-block condition, the limiting system will prevent activation of winch up, and extend out since these directions would cause damage. Winch down, boom down, boom up, extend in, and power rotation will still function so that the crane can be moved to a safe configuration.

CAUTION!

Never de-activate or override safety functions. Doing so can result in serious damage to the crane and possibly injury or death.

LOAD SENSOR

A pressure activated switch in the elevation cylinder acts as a load sensor. This switch is normally closed and opens at the preset pressure corresponding to the load rating of the crane.

CAUTION!

The load sensor will not function when the elevation cylinder is fully retracted and is inaccurate when the boom is below horizontal.

CAUTION!

The operator must never rely strictly on the load sensor to determine overload conditions. The load and load limits must always be known and adhered to.

ANTI-TWO BLOCK

The anti-two block device (optional on smaller electric cranes), mounted on the boom crown plate, consists of a normally open switch actuated by a lever. A weight is attached to the lever and holds the switch

closed. If the weight is lifted by the hook or travel block the switch opens.

The power and signal wires are wired through the cord reel, which is in turn wired to the ATB switch.

LIMITING SYSTEM CONTROL

Two systems are included to limit crane overloads and wire rope breakage. When a crane overload occurs, the load sensor will stop winch up, extension out and boom down. To prevent breaking the wire rope, the Anti Two-Block device stops winch up and extension out when either is engaged.

The capacity of boom up is limited by the pressure setting of the relief valve in the manifold.

There is a one second delay before the deactivation of boom down when the load sensor is tripped to prevent false readings caused by pressure spikes.

MISCELLANEOUS

UP LIMIT SWITCH

The up limit switch prevents the elevation cylinder from reaching full extension. If the elevation cylinder were to "dead-head", the resulting pressure would activate the load sensor, preventing boom down. The boom would then have to be lowered using the manual operation buttons on the solenoid valves.

CIRCUIT BREAKER, FUSE

For electric cranes a 150 Amp circuit breaker is supplied with the crane. It should be installed as close to the battery as possible. For hydraulic cranes a 10 Amp blade type fuse is supplied.

DISCONNECT SWITCH

A power disconnect switch is supplied with the crane. Power to the crane should be turned off whenever not in use. This is to prevent inadvertent or unauthorized use and will help prevent corrosion at electrical connections.



HYDRAULIC SYSTEM

Integrated Hyd Proportional

The hydraulic system consists of the hydraulic swivel, manifold with solenoid valves, cylinders, motors, and tubing and hoses. Hydraulic power is received from an external hydraulic source, typically a PTO driven pump attached to the vehicle transmission. The hydraulic system uses open center valves in series so that multiple functions can be operated simultaneously.

SWIVEL- (NOT USED IN 1032 OR 1640)

The hydraulic swivel is a two-port swivel that allows continuous, unlimited rotation. Refer to drawing (20498) for more information.

MANIFOLD

The hydraulic manifold consists of a differential pressure sensing flow control valve, the system relief valve, proportional flow control valve, and 4 way directional control valves.

The differential pressure sensing (DPS) valve is a pilot operated pressure compensated flow control cartridge valve located in cavity CT1. It supplies the required flow to the manifold and returns excess flow to the tank so that pressure drop and heat build up are minimized.

The system relief valve prevents damage that would be caused by excessive pressure in the system. It is a cartridge type valve located in cavity CT2. Factory setting is 2800PSI.

The proportional valve is an electrically operated flow control valve. It allows the operator to control the flow, and therefore the speed, of the selected functions. The flow output is directly proportional to the electrical input. The valve may be operated manually by depressing the manual operation button on the top of the valve.

Each hydraulically operated function is controlled by a 4 way, 3 position open center solenoid valve. It is electrically operated and spring biased to center. A manual operation button is incorporated in the coil retaining nut.

Each hydraulically operated function is controlled by a 4 way, 3 position open center solenoid valve. It is electrically operated and spring biased to center. A manual operation button is incorporated in the coil retaining nut.

CYLINDERS

Hydraulic cylinders are double acting cylinders with integrally mounted counterbalance and pilot operated check valves. Refer to the cylinder drawings for specific information.

All cylinders use a counter-balance load holding cartridge valve on the extend port. This valve performs 3 functions:

- Controls the rate of decent when lowering the load
- Keeps load from falling in the event of sudden loss of system pressure, such as when a hose bursts.
- Acts as a relief valve to prevent damage from induced load or thermal expansion.

It allows free flow to extend then blocks flow until opened by pilot pressure to the retract port or when the relief pressure is reached.

Some cylinders utilize a pilot operated check valve on the retract port to prevent the cylinder from creeping out under no load conditions. This valve allows flow into, but prevents flow from the retract port, thus hydraulically locking the cylinder until opened by pilot pressure from the extend port.

MOTORS

The hydraulic motors used by the rotation drive and hydraulic winch are high torque, low speed constant displacement motors.



MANUAL OPERATION

If electrical problems occur the solenoid valves may be operated manually. Refer to the manifold drawing for function valves and directions.

Directional control valves are manually operated by depressing the boot at the end of the valve. Use a blunt object (e.g. bolt or screwdriver handle) to assist in the operation.

Proportional valves are operated with either a boot or a small screw. Depress the boot or turn the screw slowly while operating a function to determine optimum speed. Turning the screw all the way in will result in rapid crane movement.

If hydraulic power is lost while a load is suspended, the load may be lowered by decreasing the setting on the counterbalance valve. This should only be done in extreme cases. The valve must be reset before the crane is returned to use.

To decrease the setting, loosen the locknut on the valve, then slowly turn the adjustment stem **CLOCKWISE** until the load begins to lower. Count the number of turns so that the valve can be returned to its original setting.

Alternately, a pressure gage must be put on the retract port to adjust the setting so that approx. 1800 PSI is required to lower the boom with no load.

Test the setting by lifting a known load near the moment rating of the crane.



BASIC TROUBLESHOOTING

The following chart gives a quick reference to help identify and correct problems. Refer to the following pages for more detailed information.

PROBLEM	PROBABLE CAUSE	CORRECTIVE ACTION
NO FUNCTIONS WORK	<p>Not receiving electrical power</p> <p>Not receiving hydraulic power</p> <p>Control problem</p>	<p>Check all connections Check all fuses and circuit breakers Check for electrical power at first electrical connection and trace back to crane</p> <p>Check flow from pump Deadhead cylinder and check pressure at pump</p> <p>See control section</p>
<p>FUNCTION NOT WORKING</p> <p style="padding-left: 40px;">winch up, extension out not working</p> <p style="padding-left: 40px;">Boom down, winch down, extension in not working</p> <p style="padding-left: 40px;">Other function not working</p>	<p>No signal from ATB or Load sensor (switch tripped, bad switch, bad wiring or not receiving power)</p> <p>Relay card malfunction</p> <p>Not receiving enough pressure</p> <p>Faulty wiring</p> <p>Valve coils bad</p>	<p>Check input signal to relay board if no signal, trace back to switch</p> <p>Check LEDs on board for error codes and outputs</p> <p>Deadhead cylinder and check pressure at pump Check differential pressure valve for contamination Check relief valve for proper setting and possible contamination</p> <p>Check all wiring for breaks or shorts Check all ground wires for good connection</p> <p>Check coil resistance</p>
<p>ALL FUNCTIONS SLOW</p> <p style="padding-left: 40px;">* These items only apply to cranes with proportional control systems.</p>	<p>Not receiving enough flow</p> <p>Low battery voltage Check with engine running</p> <p>* Proportional valve problem</p> <p>* Control problem</p>	<p>Check fluid levels Check all filters and any other restrictions</p> <p>Charge battery (BATTERY MAY BE BAD)</p> <p>Try manual operation of proportional valve</p> <p>Check voltage at valve for approx. at min and max(see troubleshooting form for specific valves)</p> <p>See control section</p>



TROUBLESHOOTING HYDRAULIC CRANES

GENERAL

If a problem exists, always start with the basics and work towards the more complicated.

First ensure that the crane is receiving full voltage and the pump is generating full flow and pressure. Typical requirements are 12VDC, 6GPM, and 2750PSI. Refer to the crane specification sheet for specifics.

Next determine if the problem is electrical or hydraulic. In general, if the crane can be operated manually, then the problem is electrical. If manual operation does not work then the problem is hydraulic.

If functions do not work under load or if hoist down, boom down, and extend in do not work the problem is likely lack of pressure. This may be caused by inadequate supply pressure, malfunction, contamination in the DPS or system relief valve.

If hoist up, boom down, or extend out do not work, the problem may be in the safety system. If all three of these functions do not work and other functions do the problem must be in the safety system. The status indicators on the crane RELAY BOX (see dwg.) should confirm any errors.

If the crane has proportional control and either no functions work or all functions are slow, refer to the proportional troubleshooting section.

SAFETY SYSTEM

To check functions controlled by the safety system check the status indicators. If only one of the safety functions is not working, activate that function and check for error codes and/or its output status indicator.

For non-FM systems, if the status indicator lights then the problem is in the wiring or in

the solenoid coil. If the light does not illuminate, check the control pendant. If the control pendant is good then the crane RELAY BOX needs to be replaced.

For FM systems, check for error codes. If none are present, see the FM Troubleshooting section.

If all three safety functions are not working confirm that the control board has power. Confirm that the board is receiving a signal from the ATB and load sensor. If the board is not receiving both signals Error Code 4 (Error Code 4 or 5 for the FM) should be active.

If the error code is active, ensure that the crane is not overloaded and that the ATB lever is holding the switch closed. Check for voltage at the ATB and Load Sensor inputs.

CHECK LOAD SENSOR SWITCH

If the load sensor input is not receiving voltage, locate the load sensor connector inside the crane housing. The plug side will have a red wire and a gray wire, the receptacle side will have a red and a white wire.

Disconnect and check for continuity between the two pins on the receptacle (switch side). If there is no continuity then the load sensor is bad and needs to be replaced.

CHECK ATB SWITCH

If the ATB input is not receiving voltage remove the ATB housing cover and disconnect the connector. Check for continuity on the switch side. Lifting the weight should break the continuity. If either of these conditions is incorrect the switch is bad and needs to be replaced.

CHECK CORD REEL

Check the ATB switch if not done so already. Locate the ATB connector inside the crane housing. The plug side will have a red wire and a black wire. The receptacle side will have a white wire and a black wire.

Disconnect the plug going to the switch. Check for continuity between the two pins on the receptacle. Have someone lift the weight on the ATB and continuity should be broken. If either of these conditions are incorrect then the cord reel is bad and needs to be replaced.

CHECK POWER TO SAFETY SWITCHES

If the safety switch is good, check for voltage at pin 1 (the red wire) on the plug. If there is no voltage, follow the wire back to the 6-pin power distribution plug, checking for breaks or shorts.

Remove the power distribution receptacle (cap).

NOTE!

Removing the cap will disconnect power to all electrical components. Be sure to replace the cap before continuing.

Check the cap for bent pins. Check that all wires are fully seated in the plug. If they are not, then remove the green locking wedge and push the wires forward until seated. Reinstall the wedge ensuring that no wires are pushed back.

Check the input voltage to the plug (the pin the fuse holder is connected to). If there is no voltage there, then no component will get power. Check the fuse in the crane and any other fuse or circuit breaker that may be installed. Start at the battery and trace the wiring back to the crane checking for power at each component until the problem is found.

SOLENOID VALVES

If one function does not work, try to operate it manually. If it does not work either the solenoid or the applicable actuator is malfunctioning. Contact Liftmoore for more information.

If it works manually, then the problem is electrical. Disconnect the electrical connector going to the applicable solenoid valve.

Check the voltage between the applicable direction pin on the plug (harness side) and ground. When the switch is activated, the voltage should be 12V (battery voltage).

If no voltage is received, check the continuity between the pin and the applicable pin on the crane control socket. If there is no continuity, then a wire must be broken. If the wiring is good, then the problem is with the control pendant.

If the voltage checks good, check the resistance on the coil. Connect an ohmmeter to the applicable pin on the receptacle and ground. The resistance should be between 5 and 6 ohm. If the resistance is near zero then the coil is shorted and needs to be replaced.

If the circuit is open then check where the coil is grounded on the valve. Also check for continuity between the manifold and the crane. If there is no continuity, remove one of the manifold mounting bolts and clean under the head and reinstall.

PENDANT NON - FM

If no functions work, check that Pin E on the crane control socket has power.

If the crane control socket is getting power, then check that the power wire is not broken. Select a function and direction then check continuity between pin E and the activated function/direction on the pendant control plug. If there is no continuity then the pendant needs to be repaired or replaced.

If a function is not working, check continuity between that function and Pin E on the pendant control plug. There should be continuity once the switch is activated in selected direction. The continuity should break when the switch is released. If not, the pendant needs to be repaired

TROUBLESHOOTING THE PROPORTIONAL SYSTEM

21398 HALL EFFECT, 12V Diplomatic Coil

If no functions work or if all functions are slow when controlled by the pendant, but work correctly when the manual operation button is pressed on the proportional valve then the problem is with the proportional electronic control system.

Proportional Valve Parameters

Cracking voltage	2.6V
Full open voltage	7.75V
Coil Resistance	3.66Ω

CHECK VOLTAGE AT VALVE

Have the engine running to generate sufficient voltage (13-14V). As the trigger is pulled the valve voltage should start near zero, jump to the valve cracking voltage after slight trigger travel, increase steadily as the trigger is pulled, reaching the full open voltage.

If the voltages are correct, check the resistance across the coil. If the resistance differs significantly from the nominal resistance replace the coil.



DEUTSCH CONNECTIONS & PINS

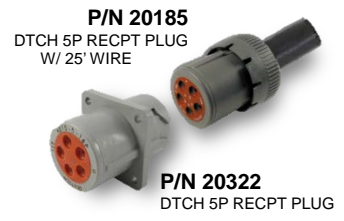

FEMALE'S

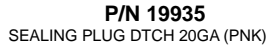

MALE'S

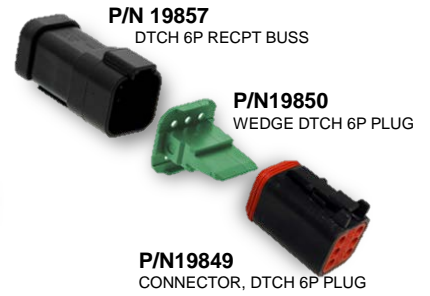
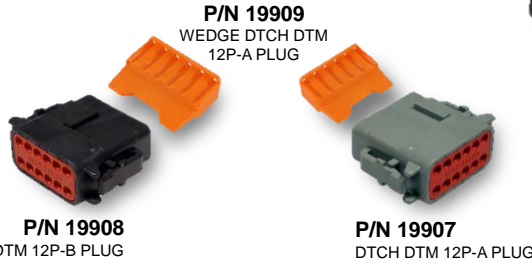
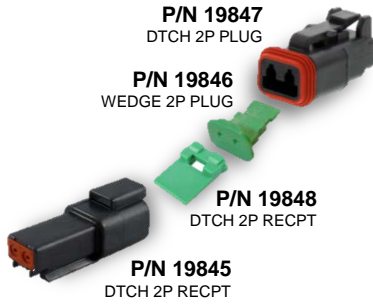

F2435-0
06/16/16
I:FORMS

HOUSTON, TEXAS
FAX: (800) 824-5559 (USA & Canada)
FAX: (713) 688-6324
PHONE: (713) 688-5533
www.liftmoore.com

SECTION 3 CRANE SPECIFICATIONS

MODEL 1032 CRANES

MOMENT RATING 10 000 FT-LBS

MAX SINGLE LINE LOAD 1 600 LBS

MAX DOUBLE LINE LOAD 3 200 LBS

LIFTING CAPACITIES AT VARIOUS LOAD RADII

LOAD RADIUS (FT)	CAPACITY (LBS)
<3.2	3200
5	2000
7	1429
9	1111
11	909
13	769
15	667
17	588
20	500

POWERED FUNCTIONS AND EXPECTED TIMES

WINCH	UP: 3 s	DOWN: 3 s	1 REVOLUTION
BOOM ELEVATION	UP: 7.4 s	DOWN: 7.0 s	
BOOM EXTENSION	OUT: 12.2 s	IN: 11.8 s	
ROTATION	90° 10.6 s		

HYDRAULIC REQUIREMENTS:

PRESSURE	2500 PSI
FLOW	6 GPM

ELECTRICAL REQUIREMENTS

VOLTAGE	12 VDC
FUSE	15 AMP

NOTE: FUNCTION TIMES ARE BASED ON THESE INPUT VALUES



F1642-B
1/22/16

HOUSTON, TEXAS
FAX: (800) 824-5559 (USA & Canada)
FAX: (713) 688-6324
PHONE: (713) 688-5533
www.liftmoore.com

PERIODIC MAINTENANCE SCHEDULE MODEL 1032 CRANES		
BOLTS		
MOUNTING BOLTS	1/2-20 GRADE 8 TORQUE 120 FT-LBS DRY	EVERY 4 MONTHS
LUBRICATION		
GREASE FITTINGS	SEE DRAWING 50460	EVERY OTHER WEEK
HYDRAULIC FLUID	STANDARD Chevron AW Hydraulic Oil 46 or equivalent SAE 15 weight oil COLD WEATHER AW 32 or equivalent SAE 10 weight oil	CHECK DAILY, FILL AS NEEDED
ROTATION GEARBOX	Sunep 460 gear oil or AGMA Grade 7EP oil	EVERY MONTH
BEARING (ZERK AND TEETH)	Oil Center Research PM 600 Military grease or equivalent Benton Based Grease NLGI Grade 2	EVERY 6 HOURS OF OPERATION



CRANE LUBRICATION POINTS

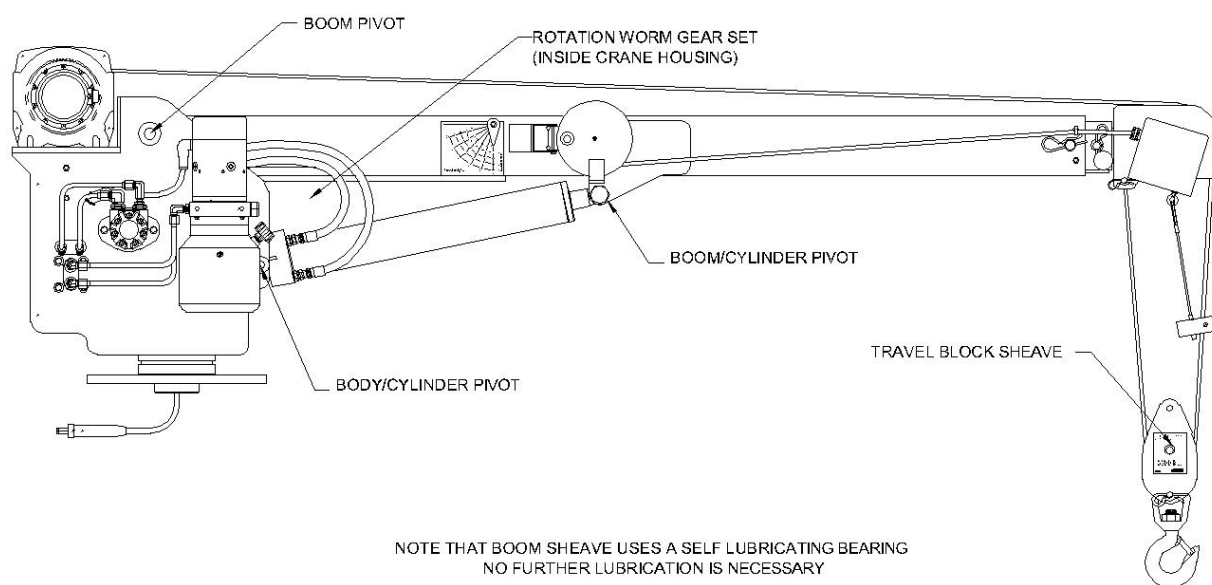

Houston TX
(713)-688-5533
www.liftmoore.com

DRWN BY: BLF
DATE: 3/18/03

CRANE LUBRICATION POINTS 8.1K-16K

DRAWING NO.
50460-A



F1642-B
1/22/16

HOUSTON, TEXAS
FAX: (800) 824-5559 (USA & Canada)
FAX: (713) 688-6324
PHONE: (713) 688-5533
www.liftmoore.com

THIS PAGE INTENTIONALLY LEFT BLANK



F1642-B
1/22/16

HOUSTON, TEXAS
FAX: (800) 824-5559 (USA & Canada)
FAX: (713) 688-6324
PHONE: (713) 688-5533
www.liftmoore.com

LIST FOR BOX, CRANE PARTS 1032XP

Items with * have detailed DWG's.

P/N 25998 - BOX, CRANE PARTS 1032XP-15 GUIDER KTG
HORN & E-STOP, ROTATION ADJUSTER

- | | | |
|-----|---|------|
| 1) | P/N 25997- MANUAL, CRANE 1032XP GUIDER KTG..... | 1pc |
| 2) | P/N 21154 - FUSE, 30 AMP BLADE..... | 1pc |
| 3) | P/N 18457 - FUSE HOLDER, ATO 12GA SEALED..... | 1pc |
| 4) | P/N 19487 - CW, 10 GA X 300"..... | 1pc |
| 5) | P/N 30760 - PIN, HITCH 0.75 X 4.50 W/H-PIN..... | 1pc |
| 6) | P/N 30815 - SCREW, HHC 0.50-13 X 2.50 GR8..... | 4pcs |
| 7) | P/N 30474 - WASHER, LOCK 0.50 GR5 PLATED..... | 4pcs |
| 8) | P/N 31957 - NUT, HEX 0.50-13 GR8 PLATED..... | 4pcs |
| 9) | *P/N 27343 - BLOCK, TRAV ASSY 3.2K lbs/4.0D..... | 1pc |
| 10) | P/N 32613 - ADAPTER, 8MJ-10MJ..... | 1pc |
| 11) | P/N 32545 - ADAPTER, 6MP-8MJ..... | 1pc |
| 12) | P/N 32546 - ADAPTER, 6MP-10MJ..... | 1pc |
| 13) | P/N 31864 - ADAPTER, 6FP-6MP SWIVEL..... | 2pcs |
| 14) | P/N 17012 - SWITCH, TOGGLE SPST MAINT. /S..... | 1pc |
| 15) | P/N 17011 - BRACKET, SWITCH MNT. HYD. CRN..... | 1pc |
| 16) | P/N 16781 - TERMINAL, RING 10-12 GA #8..... | 2pcs |
| 17) | P/N 17013 - PLATE, ON-OFF FOR TOGGLE SWCH..... | 1pc |
| 18) | P/N 18600 - PLATE, CRANE-TRUCK STABILITY CHART..... | 1pc |
| 19) | P/N 22430 - INSTALLATION INTS. 1032..... | 1pc |
| 20) | P/N 24945 - DECAL, LOAD CAPACITY 10,000..... | 1pc |
| 21) | P/N 23144 - LEVEL AND TAPE ASSEMBLY..... | 1pc |



F2120-B
05/26/15

HOUSTON, TEXAS
FAX: (800) 824-5559 (USA & Canada)
FAX: (713) 688-6324
PHONE: (713) 688-5533
www.liftmoore.com

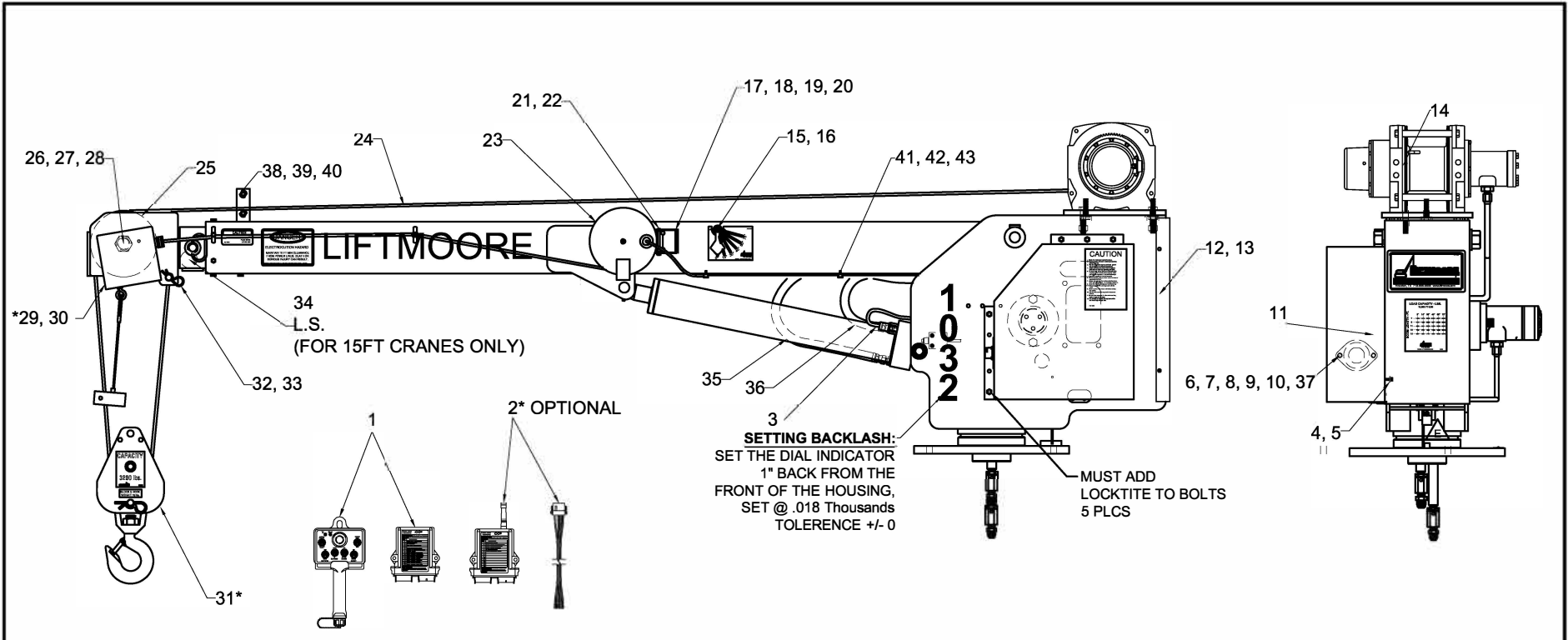

ITEMS WITH * HAVE DETAIL DRAWINGS

#	PN	DESCRIPTION	QTY	#	PN	DESCRIPTION	QTY	#	PN	DESCRIPTION	QTY
1	24572	CONTROL, FM ASSY KT GUIDER	1	17	70012	BRACKET, CORD REEL	1	33	31603	CLIP, HAIRPIN 0.50 - 0.62	1
2	24455	CON., ENGINE/AUX REC. W/21336 EWH.	1	18	30833	NUT, HEX NYLOC 0.25-20 GR2	2	34	31036	STOP, BOOM INNER ASSY STD.	1
3	21213	SWITCH, PRES ASSY 1450PSI DTCH	1	19	31110	WASHER, FLAT 0.25 GR5 PLATED	2	35	33975	HOSE, HYD #6 47.00"	1
4	31933	SCREW, SOC HD 0.25-20 X 0.50 (GRND)	1	20	30457	SCREW, HHC 0.25-20 X 0.75 GR5	2	36	33999	HOSE, HYD #6 42.00" ST-ST	1
5	30889	WASHER, LOCK 0.25 GR5 PLATED	1	21	33410	SCREW, MH RD 10-24 X 3.00	1	37	20815	PLATE, CONTROL SOCKET 5-PIN MC	1
6	25206	EWH, DTCH HYD KTG FM XP	1	22	33409	NUT, HEX NYLOC 10-24 GR2	1	33	31603	CLIP, HAIRPIN 0.50 - 0.62	1
7	30457	SCREW, HHC 0.25-20 X 0.75 GR5	2	23	20407	REEL, CORD 20 FT ASSY DTCH	1	34	31036	STOP, BOOM INNER ASSY STD.	1
8	31110	WASHER, FLAT 0.25 GR5 PLATED	2	24	32995	ROPE, WIRE 0.25 X 62' W/THB&LP	1	35	33975	HOSE, HYD #6 47.00"	1
9	30889	WASHER, LOCK 0.25 GR5 PLATED	2	25	33058	SHEAVE ASSY 5.90PD X 0.25 ROPE	1	36	33999	HOSE, HYD #6 42.00" ST-ST	1
10	30830	NUT, HEX 0.25-20 GR2 PLATED	2	26	34468	SCREW, SHEAVE SINGLE 1-8 3.25	1	37	20815	PLATE, CONTROL SOCKET 5-PIN MC	1
11	30989	SCREW, HWHSMS #8 X 0.50	1	27	31258	WASHER, FLAT 1.00 SAE GRADE 8	1	NOT SHOWN:			
12	25248	COVER, BACK 1032 PLASTIC	1	28	30838	NUT, HEX NYLOC 1.00-8 GRADE 5	1	19847	CONNECTOR, DTCH 2P PLUG	1	
13	32589	SCREW, HWHSMS 0.25-20 X 0.75	4	29	22908	ATB ASSY, DEUTSCH CONNECTOR	1	19845	CONNECTOR, DTCH 2P RECPT	1	
14	70041	NUT, HEX 0.44-20 GR2	1	30	32957	CLAMP, HOSE SUPPORT 0.62 ID	1	19846	WEDGE, DEUTSCH 2P PLUG	1	
15	22394	PENDULUM, LOAD RADIUS DIA. HD	2	31	27343	BLOCK, TRAV ASSY 3.2K lbs/4.0D	1	19848	WEDGE, DEUTSCH 2P RECPT	1	
16	31017	SCREW, SHOULDER 0.31-18 X 0.75	2	32	22553	PIN, CLEVIS 0.56 X 2.5 PLATED	1	33025	PLATE, SERIAL 3200/1032	1	
								21650	DECAL KIT 1032 DTCH	1	



Houston TX
 (713)-688-5533
 www.liftmoore.com

DRWN BY: AA
 DATE: 08/07/13

CRANE ASSY 1032XP KTG
 ATB LEFT SIDE, GUIDER KTG W/HORN, ROTATION ADJUSTER

DRAWING NO.
25996-E

P/N 24453 CONTROL, FM TRANS HYD XP DRA K

P/N 24454 CONTROL, FM RECEIVER XP HE

NOT SHOWN:

P/N 20185 WIRE, CTRL FM TEATHER 5P PLUG
 P/N 20186 CAR CHARGER, FM TRANS

TRANSMITTER AND RECEIVERS ARE PROGRAMMED TO FORM A MATCHED SET SO THAT A TRANSMITTER ONLY OPERATES ONE CRANE. IF EITHER PART IS REPLACED, THE RECEIVER MUST BE PROGRAMMED TO THE TRANSMITTER USING A TEMPORARY WIRING HARNESS AVAILABLE FROM LIFTMOORE.

P1:12 PIN DEUTSCH DTM13-12PA

PIN#	DESCRIPTION	COLOR
1	GROUND	BRN
2	CAN HIGH	WHT
3	CAN LOW	GRN
4	PROGRAMMING PIN	
5	ATB SWITCH IN (DI2)	YEL/BLK
6	PRESSURE SWITCH IN (ANO)	BLU/BLK
7	NO CONNECTION	
8	PRESSURE TRANSDUCER IN (AN2)	
9	NO CONNECTION	
10	NO CONNECTION	
11	HORN OUT PUT	
12	POWER (9 TO 35 VDC)	RED

P2:12 PIN DEUTSCH DTM13-12PB

PIN#	DESCRIPTION	COLOR
1	ROTATION CW OUTPUT	RED
2	ROTATION CCW OUTPUT	RED/BLK
3	EXTENSION OUT OUTPUT	ORN/BLK
4	EXTENSION IN OUTPUT	GRN/BLK
5	BOOM UP OUTPUT	GRN
6	BOOM DOWN OUTPUT	ORN
7	HOIST UP OUTPUT	BLU
8	HOIST DOWN OUTPUT	BLK
9	PROPORTIONAL	WHT/BLK
10	RS232 GND (PALM PILOT)	
11	RE232 RX (PALM PILOT)	
12	RS232 TX (PALM PILOT)	

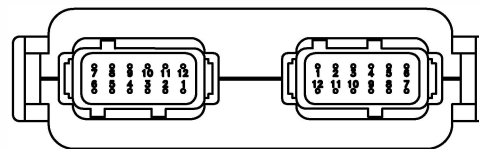
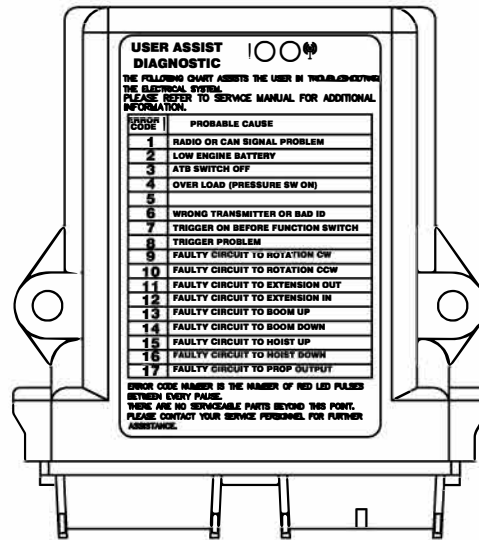
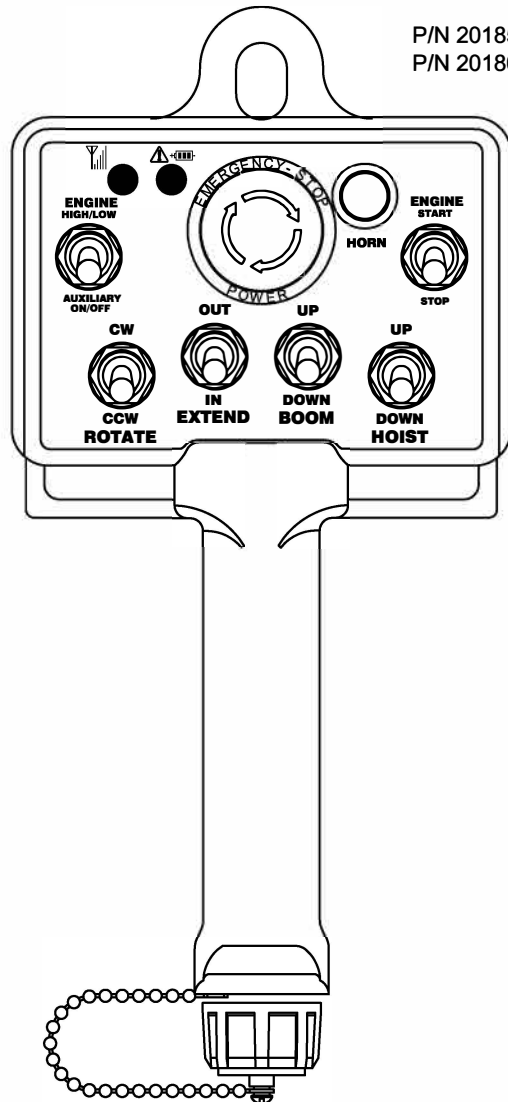

OPTIONAL:

P/N 24510 INTERNATIONAL WALL CHARGER 110V



Houston TX
 (713)-688-5533
 www.liftmoore.com

DRWN BY: JE
 DATE: 6/28/11

FM RECEIVER & TRANSMITTER XP KT GUIDER
 WITH HORN OUTPUT

DRAWING NO.
 24572-A

P/N 24455 CONTROL, FM RECEIVER ENG/AUX GUIDER

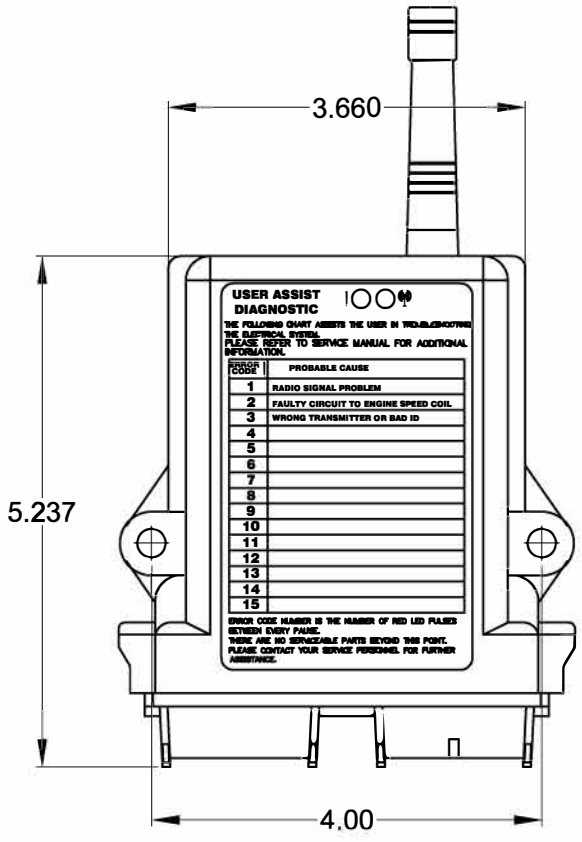

USER ASSIST DIAGNOSTIC

THE FOLLOWING CHART ASSISTS THE USER IN TROUBLESHOOTING THE ELECTRICAL SYSTEM. PLEASE REFER TO SERVICE MANUAL FOR ADDITIONAL INFORMATION.

ERROR CODE	PROBABLE CAUSE
1	RADIO SIGNAL PROBLEM
2	FAULTY CIRCUIT TO ENGINE SPEED COIL
3	WRONG TRANSMITTER OR BAD ID
4	
5	
6	
7	
8	
9	
10	
11	
12	
13	
14	
15	

ERROR CODE NUMBER IS THE NUMBER OF RED LED FLASHES BETWEEN EVERY FLASH.
THERE ARE NO SERVICEABLE PARTS BEYOND THIS POINT. PLEASE CONTACT YOUR SERVICE PERSONNEL FOR FURTHER ASSISTANCE.

P/N 21336 EWH, ENGINE CTRL RCVR KTFM DRA

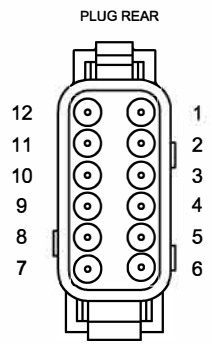
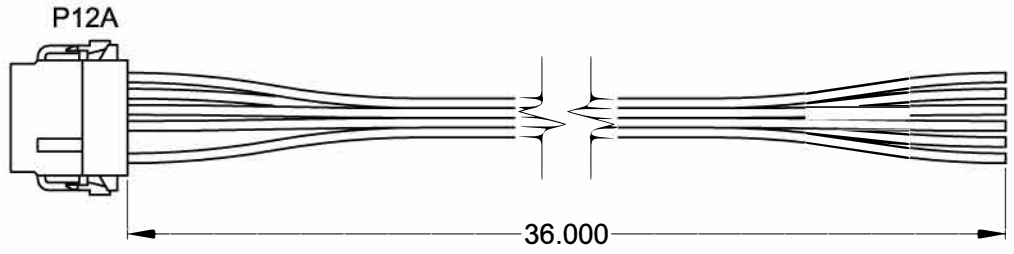

P12A - ENGINE RECEIVER		
PIN	COLOR	DESC
1	BLK	GRND
8	YEL/BLK	AUX
9	BRN	ENG START
10	GRY	ENG STOP
11	BLU/BLK	ENG HI IDLE
12	RED	PWR
SEAL PIN IN ALL OTHER CONTACTS		
SUPPLY VOLTAGE TO PIN 5 TO CHANGE ENG HI IDLE OUTPUT TO MOMENTARY		

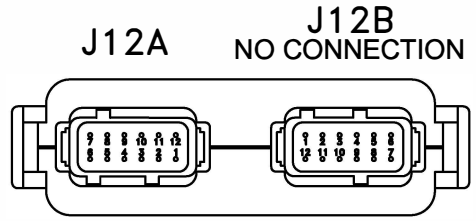

SEE FORM 1214 FOR GENERAL INFORMATION ON INTERFACING WITH ECM AND CONTACT INFORMATION FOR VEHICLE AND ENGINE MANUFACTURES



Houston TX
(713)-688-5533
www.liftmoore.com

DRWN BY: JE
DATE: 4/21/11

FM ENGINE CONTROL REPRESENTATION
WITH AUXILIARY FUNCTION, 3RD GEN KTFM GUIDER

DRAWING NO.
24455-0

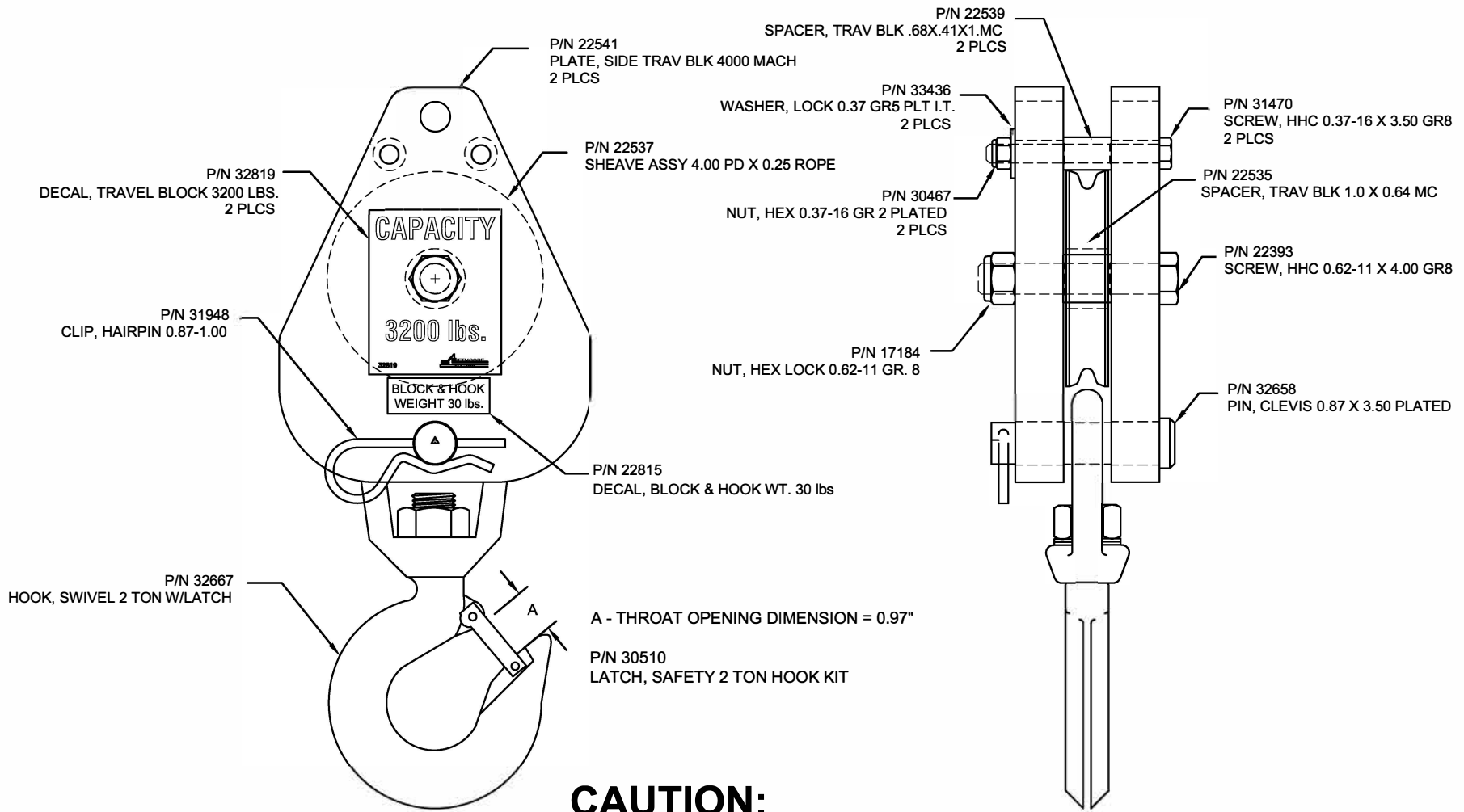

CAUTION:

NEVER USE A HOOK WHOSE THROAT OPENING HAS BEEN INCREASED, OR WHOSE TIP HAS BEEN BENT MORE THAN 10 DEGREES OUT OF PLANE FROM THE HOOK BODY, OR IS IN ANY WAY DISTORTED OR BENT.



Houston TX
 (713)-688-5533
 www.liftmoore.com

DRWN BY: AA
 DATE: 05/26/15

BLOCK, TRAV ASSY 3.2K lbs/4.0D
 1032 TRAVEL BLOCK

DRAWING NO.
27343-A

NOTE: WIRE SHOULD BE SECURED TO SHEAVE BOLT TO ENSURE THAT IT DOES NOT INTERFERE WITH THE LEVER

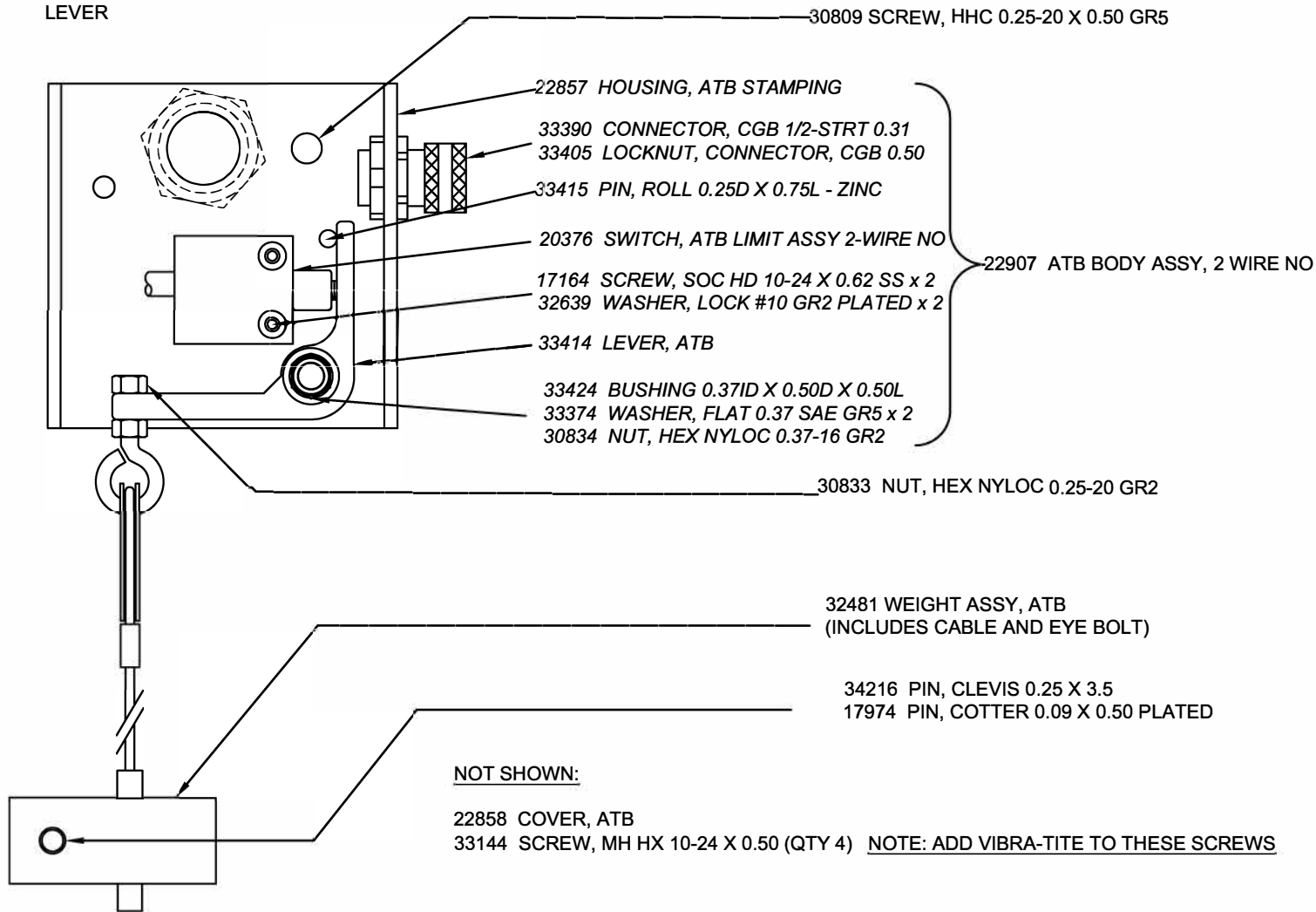

Houston TX
(713)-688-5533
www.liftmoore.com

DRWN BY: JC
DATE: 07/02/09

ATB ASSY, DEUTSCH CONN
TWO-WIRE NORMAL OPEN; LEFT SIDE

DRAWING NO.

22908-B

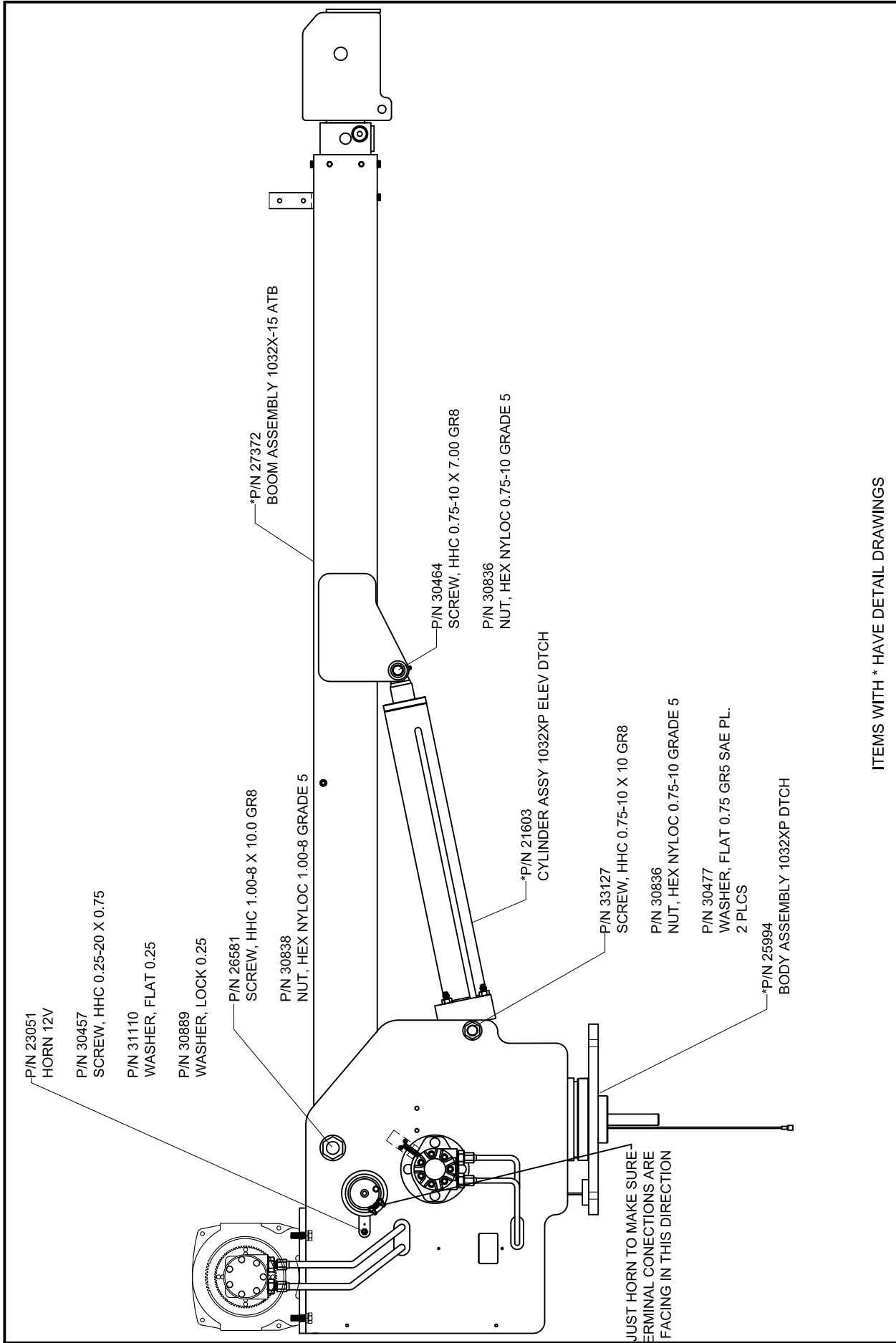

JUST HORN TO MAKE SURE
 TERMINAL CONNECTIONS ARE
 FACING IN THIS DIRECTION

ITEMS WITH * HAVE DETAIL DRAWINGS

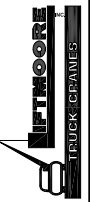

Houston TX
 (713)-688-5533
 www.liftmoore.com

DRWN BY: AA
 DATE: 06/01/15

BOOM-BODY ASSY 1032XP-15 DTCH
 ATB LS; WINCH 25048; ROTATION ADJUSTER

DRAWING NO.
27374-0

P/N 21213
 SWITCH, PRES ASSY 1450PSI DTCH
 (NOT PART OF ASSEMBLY)

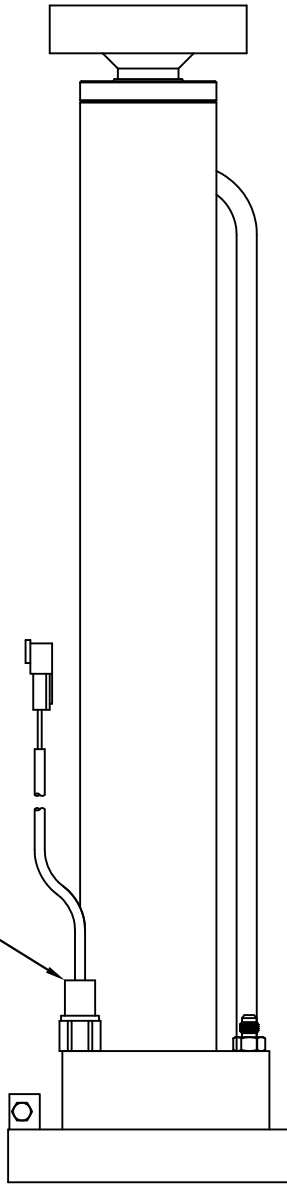

P/N 31063
 ADAPTER, 6MJ-6MO
 2 PLCS

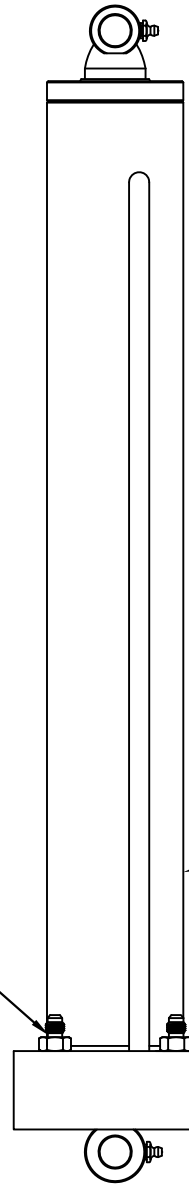

P/N 32867
 CYLINDER, 3.0 X 18.5 X 1.25 PE

REPLACEMENT PARTS FOR CYLINDER	
DESCRIPTION	PART NUMBER
SEAL KIT	TM*SK-0000148
COUNTER BALANCE VALVE	30851

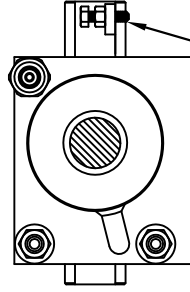

P/N 30810
 SCREW, HHC 0.25-20 X 1.00 GR5

P/N 30830
 NUT, HEX 0.25-20 GR2 PLATED

FOR UPLIMIT SWITCH

Houston TX
 (713)-688-5533
 www.liftmoore.com



CYLINDER ASSY 1032XP ELEV DTCH

DRWN BY: JC
 DATE: 05/23/08

DRAWING NO.

21603-A

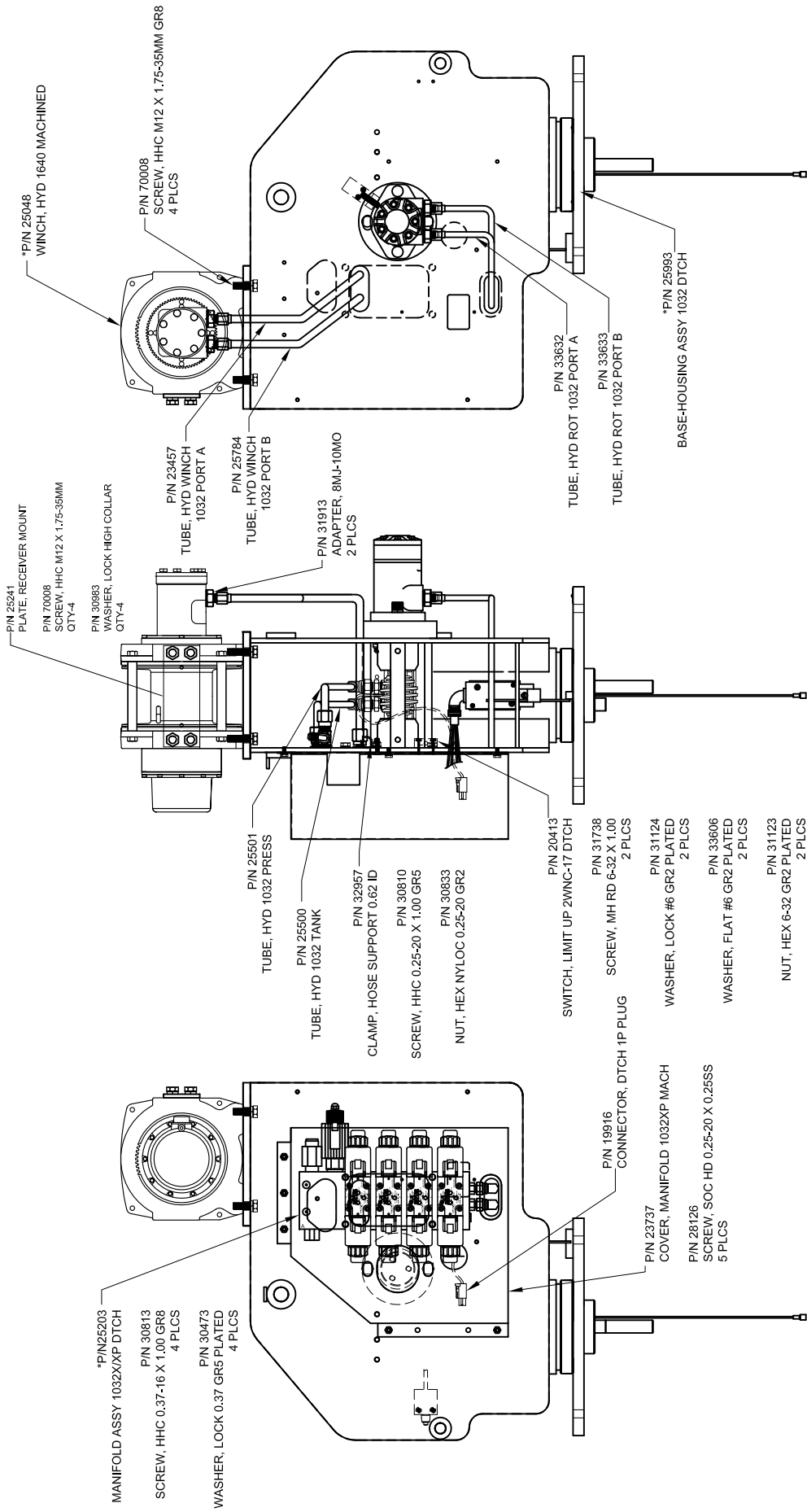

ITEMS WITH * HAVE DETAIL DRAWINGS

DRWN BY: AA
 DATE: 08/07/13

Houston TX
 (713)-688-5533
 www.iftmoore.com



DRAWING NO.

BODY ASSEMBLY 1032XP DTCH
 USE WINCH P/N 25048; DEUSTCH VALVES, ROTATION ADJUSTER

25994-D

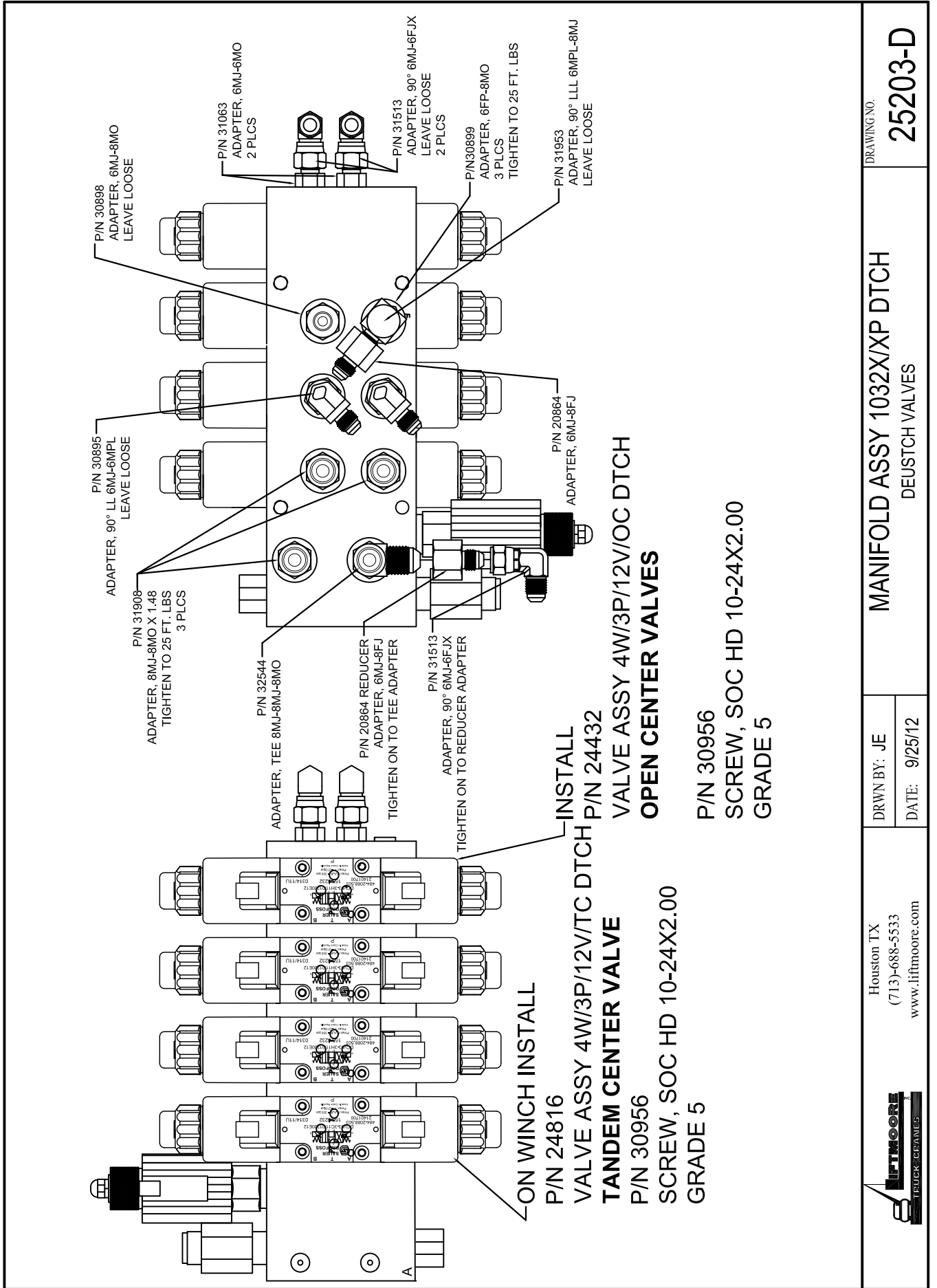

DRAWING NO. **25203-D**

MANIFOLD ASSY 1032X/XP DTCH
 DEUSTCH VALVES

DRWN BY: JE
 DATE: 9/25/12

Houston TX
 (713)-688-5533
 www.liftmoore.com



TO ADJUST BACKLASH BETWEEN GEARS:

LOOSEN MOUNTING BOLTS

MAKE SMALL ADJUSTMENTS TO THE BACKLASH ADJUSTMENT SCREWS. NO MORE THAN A 1/4 TURN. ALTERNATE BETWEEN SCREWS SO THAT ALIGNMENT IS MAINTAINED.

SOME PLAY **MUST** BE LEFT BETWEEN THE GEARS OR THE CRANE WILL NOT OPERATE PROPERLY AND EXCESSIVE WEAR AND/OR DAMAGE WILL OCCUR. INITIAL SETTING IS SUCH THAT THE RETRACTED BOOM TIP MOTION IS LESS THAN 1 INCH.

WHEN FINISHED, TORQUE THE MOUNTING BOLTS TO 40 FT.-LBS

TO ADJUST PLAY IN WORM MOUNTING:

TIGHTEN THE 3 SET SCREWS IN THE BEARING HOLDER THEN BACK THEM OUT 1 TURN

SCREW THEM BACK IN JUST UNTIL THEY ARE SNUG. OVER TIGHTENING WILL PUT THE WORM AND MOTOR IN A BIND AND IT WILL NOT FUNCTION PROPERLY.

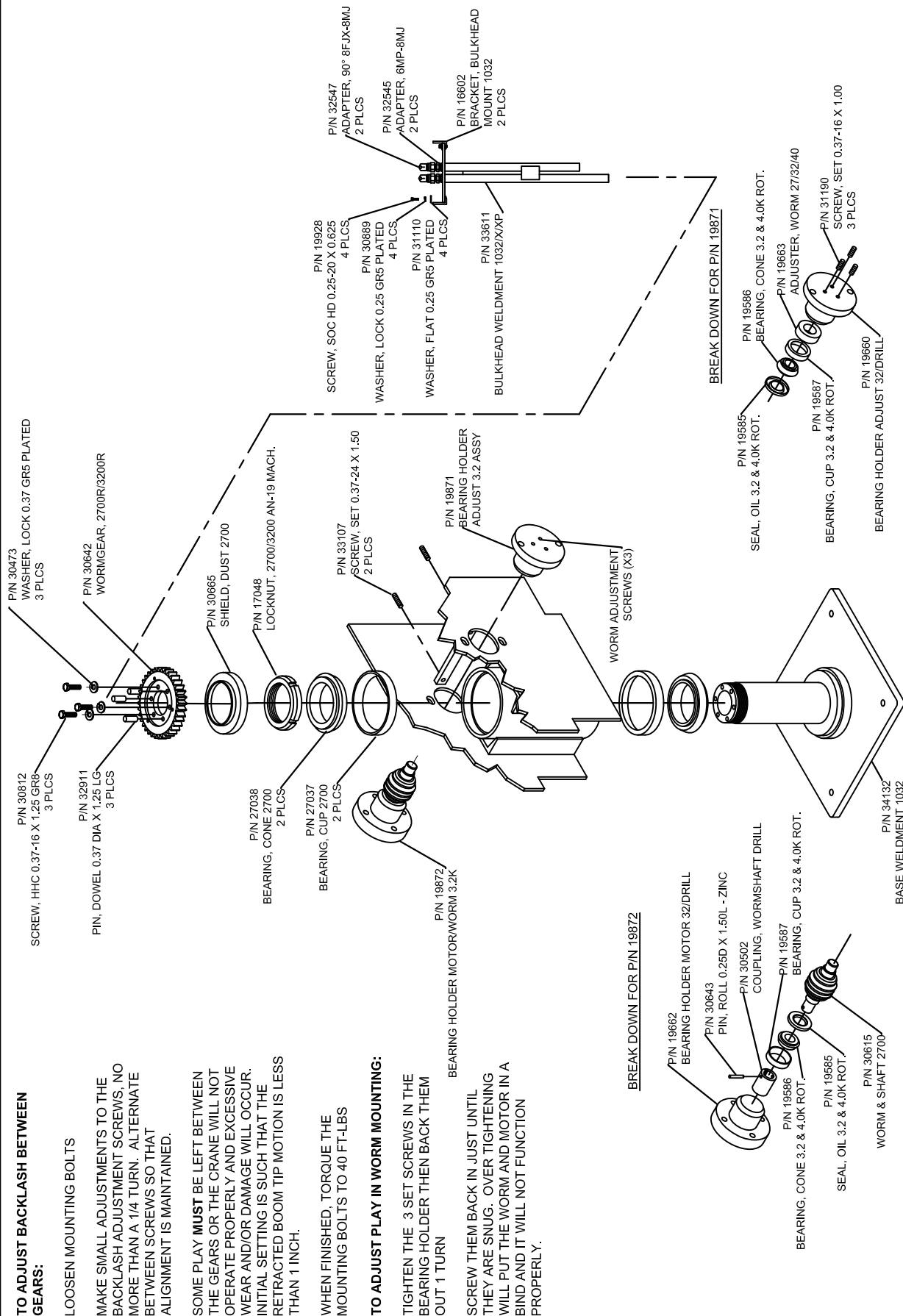

Houston TX
(713)-688-5533
www.liftmoore.com

DRWN BY: JC
DATE: 02/23/10

ROTATION COMPONENTS 1032

DRAWING NO.

50570-B

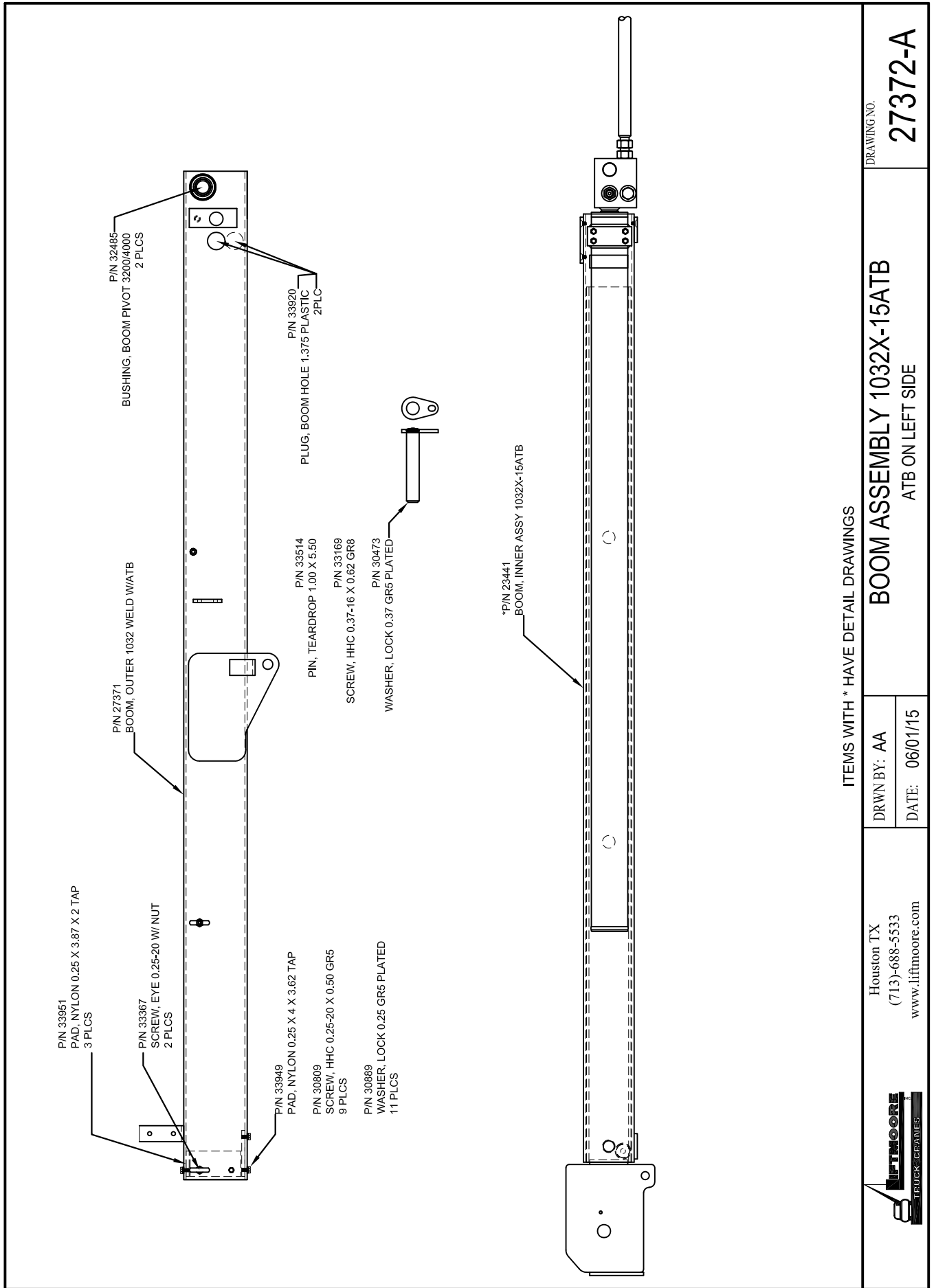

ITEMS WITH * HAVE DETAIL DRAWINGS

Houston TX
 (713)-688-5533
 www.liftmoore.com



DRWN BY: AA

DATE: 06/01/15

BOOM ASSEMBLY 1032X-15ATB

ATB ON LEFT SIDE

DRAWING NO.

27372-A

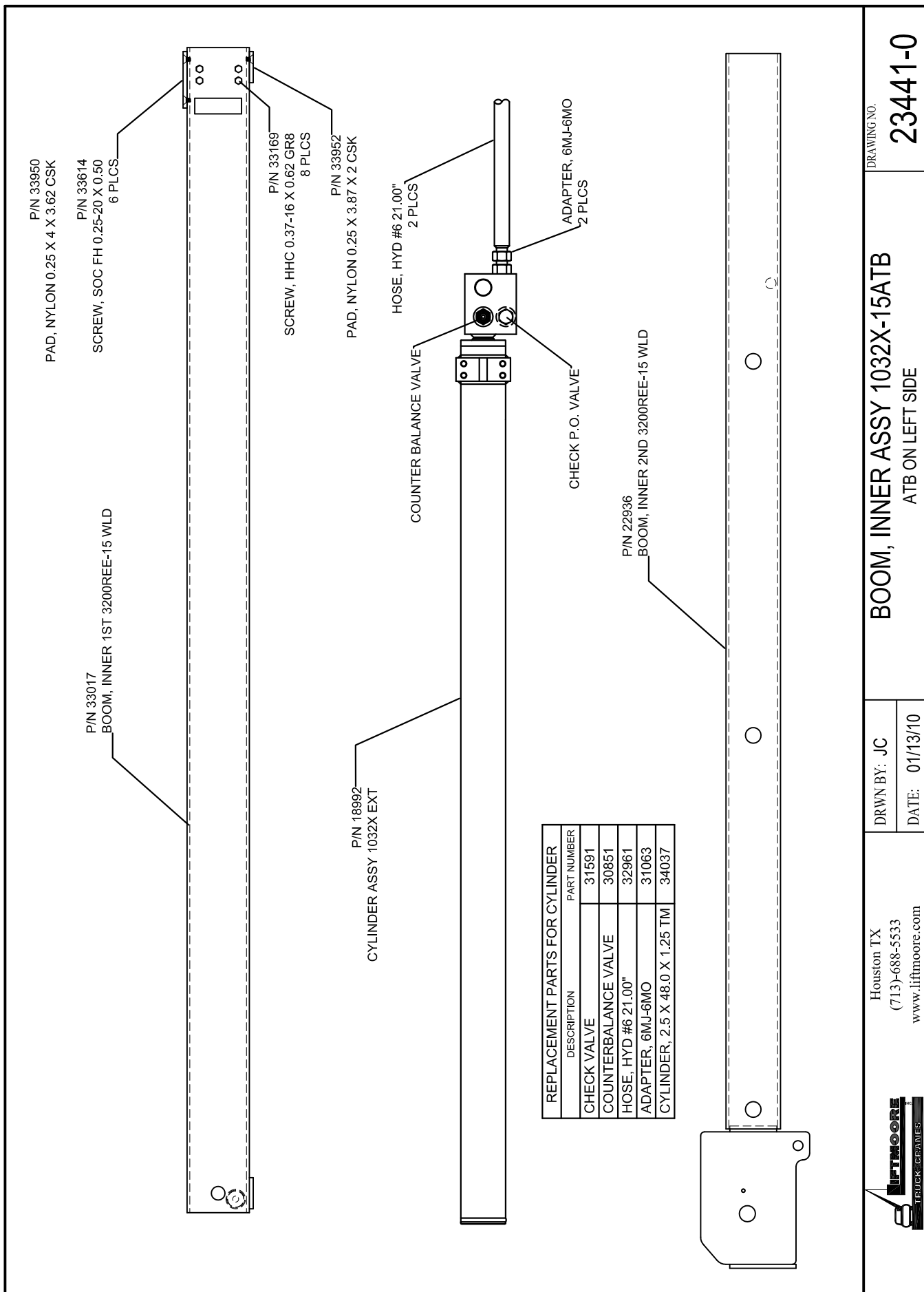

DRAWING NO.
23441-0

BOOM, INNER ASSY 1032X-15ATB
ATB ON LEFT SIDE

DRWN BY: JC
DATE: 01/13/10

Houston TX
(713)-688-5533
www.liftmoore.com



P/N 25048: WINCH, HYD WARN HY2000

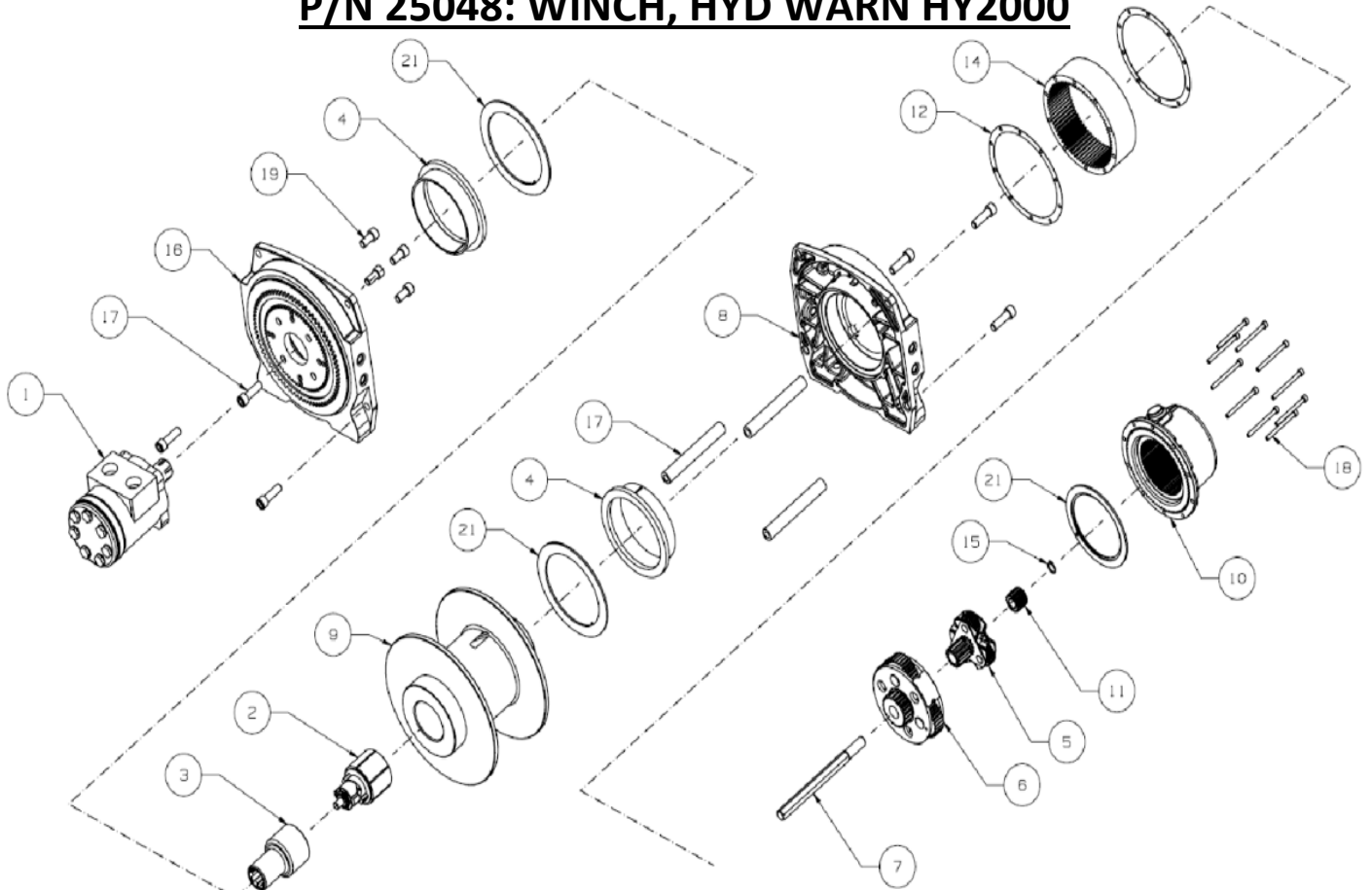

1	SVC KIT MOTOR, HYD, 1.5	90132
2	S/P BRAKE ASSY, HYDRAULIC	95320
3	DRIVER, BRAKE, HYD, DISK BRAKE	30259
4	BUSHING, DRUM, NYLON	30274
5	CARRIER (PH) ASSY, STAGE 2	34342
6	CARRIER ASSY, (PH) STAGE 3	23444
7	DRIVE SHAFT, 6.30 X .50, W/GROOVE	89096
8	(MTO)S/P DRUM, SUPPORT GEAR END	85575
9	DRUM, (KB) 2000-LF	87579
10	SVC KIT END HOUSING ASSY, CLUTCH PL	85583
11	GEAR, SUN, 18 TEETH, .50 HEX	39479
12	HOUSING, GASKET	13848
13	PARTS PACK, (PH) DC3000 HOIST	39921
14	RING GEAR, ARG, 75 TOOTH	25308
15	RING, RETAINING, 1/2	1159
16	(MTO) DRUM SPT, MOTOR END	31670
17	SVC KIT TIE ROD, ALUM, .625 X 4.58	85578
18	CPSCR, SOC, 10-24 X 2.25	13850
19	CPSCR, SOC HD, 3/8-16 X .75	30328
20	WSHR, THRUST, NYLON, MIDRANGE	13826
21	WSHR, THRUST, NYLATRON, CIM	30277

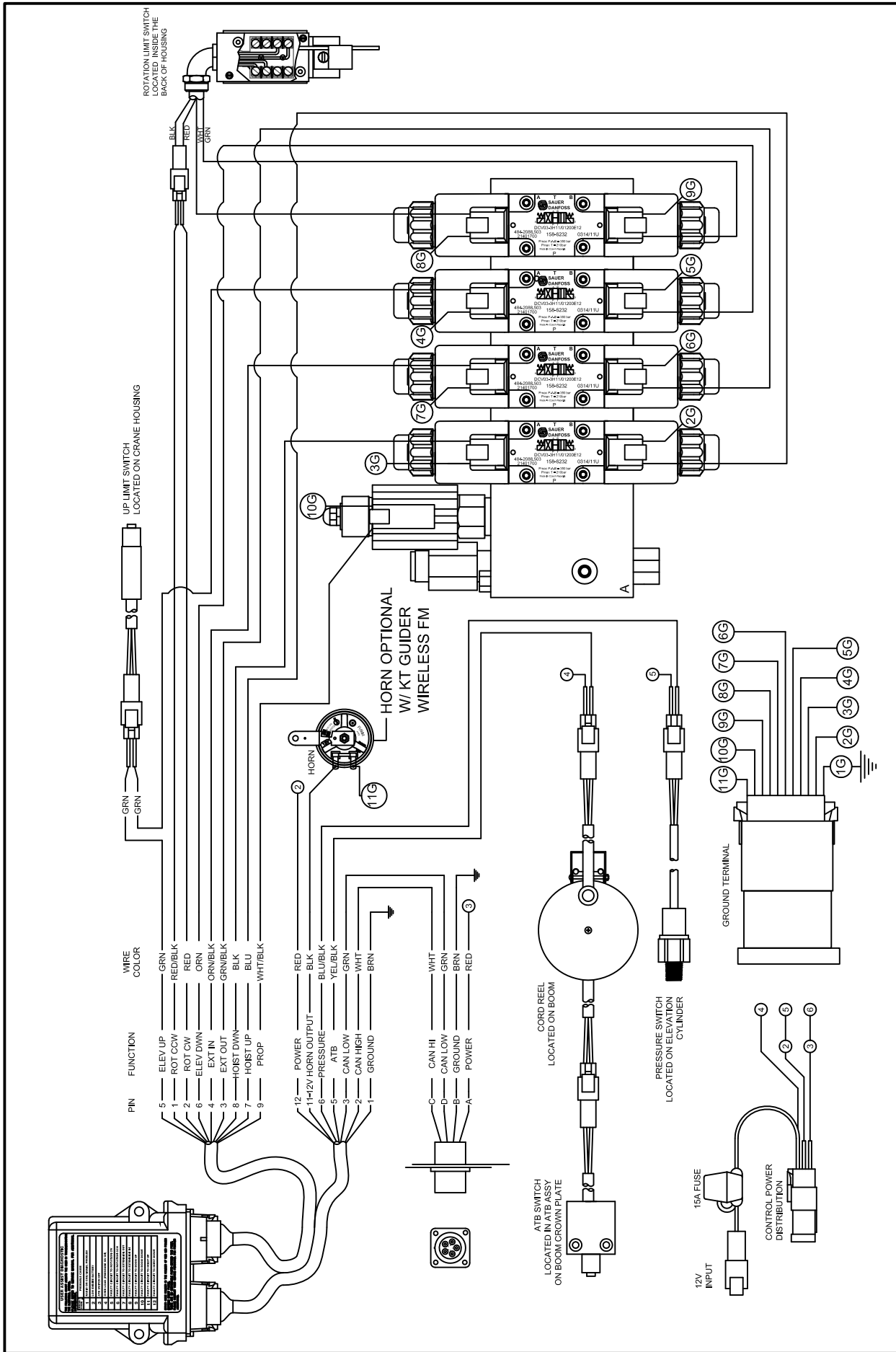

DRAWING NO. 50827-0

SCHEM, ELEC WIRING KTG XP
DTCH VALVES 1032/1640

DRWN BY: JE
DATE: 11/21/12

Houston TX
(713)-688-5533
www.liftmoore.com



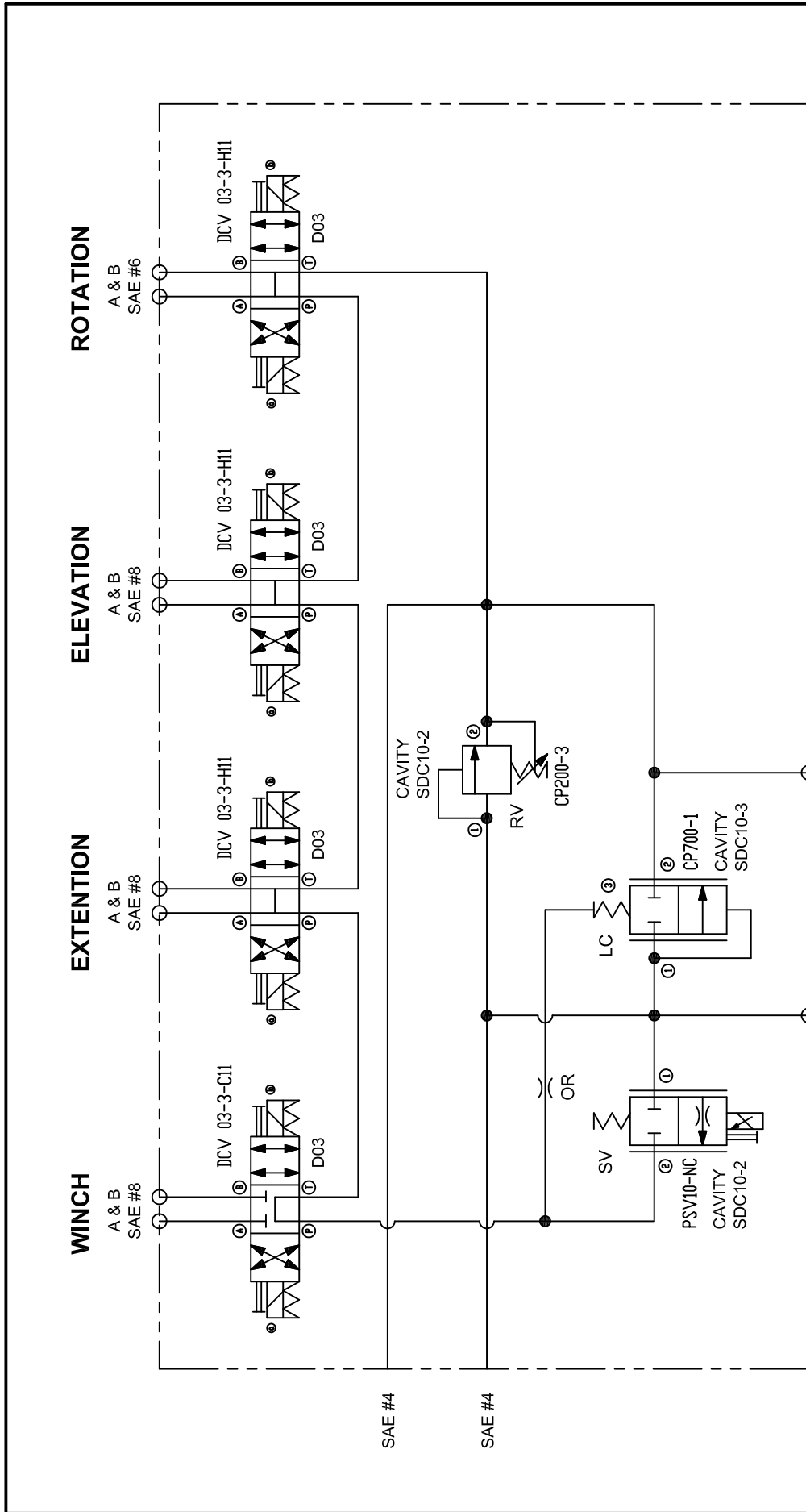

NOTE: HYDRAULIC SYSTEM RELIEF PRESSURE SET AT 2800 PSI.
FLOW RATE INTO CRANE SHOULD BE SET AT 6 GPM.



Houston TX
(713)-688-5533
www.iftmoore.com

DRWN BY: JE
DATE: 10/28/11

SCHEM, HYD PROPORTIONAL
MANIFOLD P/N 24541 TANDEM CENTER WINCH

DRAWING NO.

50813-A

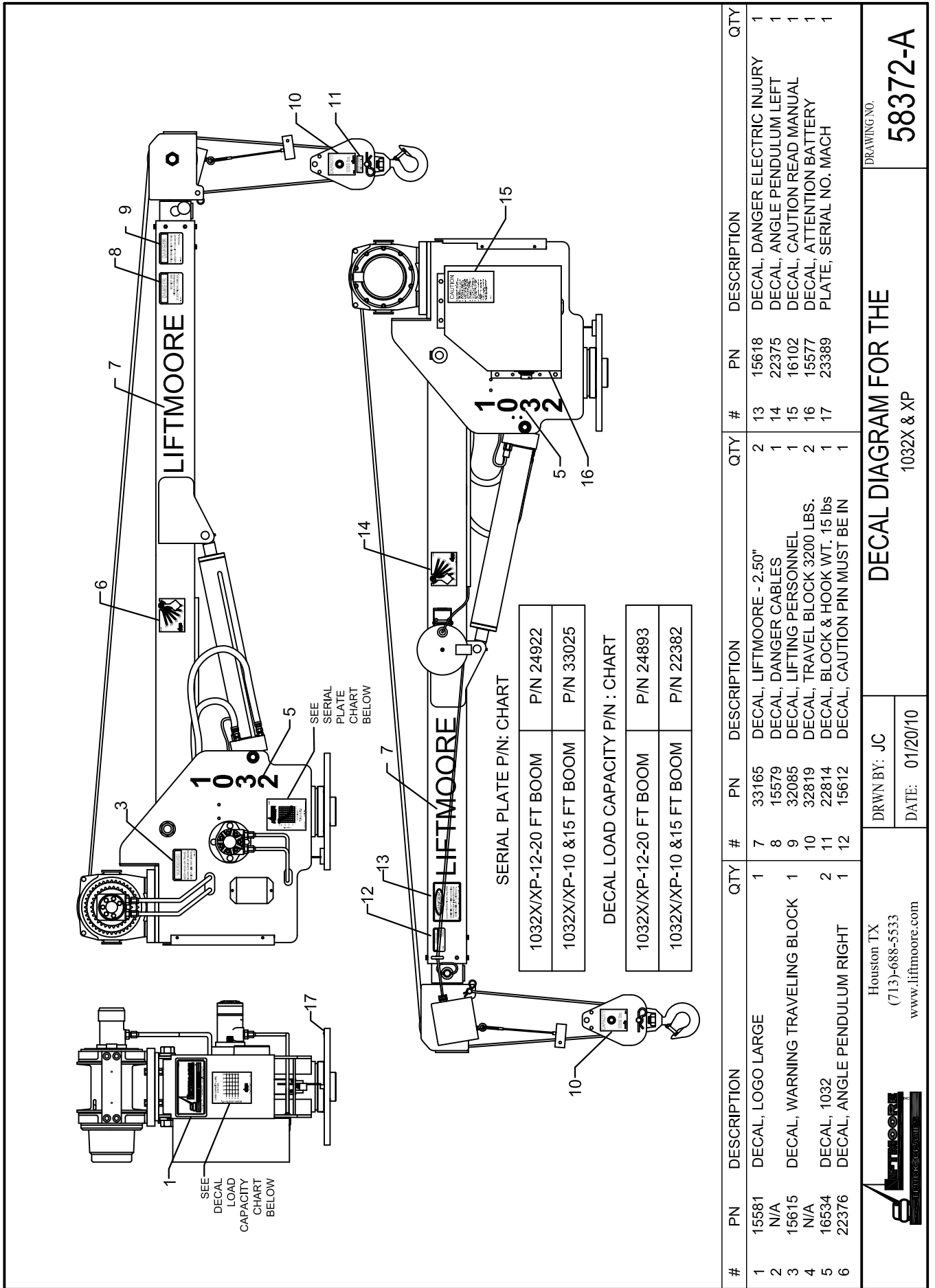

Houston TX
 (713)-688-5533
 www.liftmoore.com

DRWN BY: JC
 DATE: 01/20/10

DECAL DIAGRAM FOR THE
 1032X & XP

DRAWING NO.

58372-A

LIFTMOORE LIMITED WARRANTY

Parts and Structural

Liftmoore, Inc. warrants each LIFTMOORE crane to be free from defects in materials and workmanship for twelve (12) months from the date of delivery to the original customer. Under the terms of this warranty the crane structural components manufactured by LIFTMOORE, Inc. are warranted for thirty-six (36) months from the date of delivery to the original customer. LIFTMOORE, Inc. will repair or replace, as its sole discretion, any equipment or part that is returned f.o.b. to LIFTMOORE, Inc.'s plant at 7810 Pinemont Drive, Houston, Texas 77040, or to one of its authorized dealers, and is found by LIFTMOORE, Inc. or its authorized dealer to have been defective at the time of original delivery.

The foregoing warranty is the exclusive warranty made by LIFTMOORE, Inc. with respect to its cranes and is in lieu of all other warranties. ANY AND ALL OTHER WARRANTIES, EXPRESS OR IMPLIED, INCLUDING ANY WARRANTY OF MERCHANTABILITY OR FITNESS OF ANY CRANE FOR A PARTICULAR PURPOSE OR OPERATION, ARE HERBY EXPRESSLY DISCLAIMED.

The foregoing warranty applies only to LIFTMOORE cranes under normal use and service and does not apply in the event of damage caused by repair or alteration or damage during shipment, accident, negligence, overloading, or misuse, including operator's failure to follow any of the instructions issued with the crane.

This warranty is limited to the original purchaser and is not assignable. In order to submit a claim, the original purchaser must provide a copy of the original invoice for the crane in question within twelve (12) months following the delivery date and within 30 days from the date of repair.

The warranty applies only when the LIFTMOORE crane is used for commercial purposes and does not cover any purchase for use for personal, family or household purposes.

LIMITATION OF LIABILITY: LIFTMOORE, Inc.'s liability for any losses or damages resulting from any cause whatsoever, including LIFTMOORE, Inc.'s NEGLIGENCE or from a defective crane irrespective of whether such defects are discoverable or latent, shall in no event exceed the purchase price of the crane to which losses or damages are claimed, or at the election of LIFTMOORE, Inc., the repair or replacement of the defective crane.

In no event shall LIFTMOORE, Inc. be liable for any special, incidental, or consequential damages, including commercial losses or costs of any kind sustained by purchaser or any other person or for any damages for which purchaser may be liable to other persons by reason of any defect in any LIFTMOORE crane or any part thereof.

LIFTMOORE, Inc. reserves the right to make changes in design or construction of its cranes at any time without obligating itself to make such changes on cranes previously manufactured.

No agent, employee, or representative of LIFTMOORE, Inc. has authority to amend or modify the foregoing warranty or to bind LIFTMOORE, Inc. by any other warranty, guaranty, or assumption of liability.

In the event any provision of this warranty is for any reason held ineffective, the remaining provisions shall remain in full force and effect.

Some states do not allow limitations on how long an implied warranty lasts or the exclusion or limitation of incidental or consequential damages, so the above limitations and exclusions may not apply to you. This warranty gives you specific legal rights, and you may also have other legal rights that vary from state to state.

