

# TABLE OF CONTENTS

USERS MANUAL P/N 25763  
60100XP KTG  
24 FT BOOM

## SECTION I GENERAL OPERATION, INSPECTION, AND MAINTENANCE

CRANE SAFETY RULES .....	F1122-B .....	1-1
INTRODUCTION .....	F1111-D .....	1-3
OPERATING RESTRICTIONS .....	F1112-F .....	1-4
OPERATING PRACTICES .....	F1112-F .....	1-4
INSPECTION AND MAINTENANCE .....	F1113-D .....	1-10
MONTHLY INSPECTION REPORT .....	F1123-B .....	1-12
ANNUAL INSPECTION REPORT .....	F1507-0 .....	1-13

## SECTION II CRANE SYSTEMS AND TROUBLESHOOTING

KTG CONTROL SYSTEM .....	F1882-0 .....	2-1
KTG ENGINE CONTROL(OPTIONAL) .....	F1214-B .....	2-3
SAFETY SYSTEM.....	F1769-0 .....	2-4
PROPORTIONAL HYDRAULIC SYSTEM .....	F1299-A .....	2-5
BASIC TROUBLESHOOTING CHART .....	F1774-0 .....	2-7
TROUBLESHOOTING SAFETY SYSTEM.....	F1254-A .....	2-8
TROUBLESHOOTING PROPORTIONAL SYSTEM.....	F1447-B .....	2-9
TROUBLESHOOTING FM CONTROL SYSEM .....	F1135-B .....	2-10

## SECTION III CRANE SPECIFICATIONS

LIFTING CAPACITIES.....	F1757-0.....	3-1
POWER FUNCTIONS AND SPEEDS .....	F1757-0.....	3-1
BOLT AND LUBRICATION SPECS.....	F1757-0.....	3-2
CRANE LUBRICATION POINTS .....	F1757-0.....	3-3

## SECTION IV PARTS

BOX PARTS LIST .....	F2078-0.....	4-1
CRANE ASSEMBLY .....	DWG.25748-D.....	4-2
FM CONTROL.....	DWG.24484-A.....	4-3
ENGINE CONTROL RECIEVER(OPTIONAL).....	DWG.24455-0.....	4-4
TRAVEL BLOCK ASSEMBLY .....	DWG.22524-C.....	4-5
ANTI-TWO BLOCK ASSEMBLY.....	DWG.58406-G.....	4-6
BASE HOUSING ASSEMBLY .....	DWG.21801-E.....	4-7
BODY ASSEMBLY .....	DWG.25360-0.....	4-8
ROTATION SPEED REDUCER .....	DWG.21605-0.....	4-9
HYDRAULIC SWIVEL.....	DWG.20498-E.....	4-10
MANIFOLD ASSEMBLY .....	DWG.25344-0.....	4-11
MANIFOLD PRE-ASSEMBLY .....	DWG.24822-A.....	4-12
ELEVATION CYLINDER ASSEMBLY .....	DWG.19802-C.....	4-13



# TABLE OF CONTENTS

USERS MANUAL P/N 25763

60100XP KTG

24 FT BOOM

BOOM ASSEMBLY – 24 FT.....	DWG.25746-C.....	4-14
BOOM INNER ASSEMBLY .....	DWG.25714-0.....	4-15
BOOM OUTER ASSEMBLY .....	DWG.25711-A.....	4-16
BOOM-BODY ASSEMBLY .....	DWG.25747-A.....	4-17
WINCH.....	DWG.50530-B.....	4-18
WINCH BRAKE .....	DWG.50529-A.....	4-19
ELECTRICAL WIRING HARNESS.....	DWG.25362-0.....	4-20
ELECTRICAL SCHEMATIC .....	DWG.50823-0.....	4-21
HYDRAULIC SCHEMATIC.....	DWG.50813-0.....	4-22
DECAL DIAGRAM .....	DWG.58390-0.....	4-23
WARRANTY .....	F1442	



F2077-C  
3/16/15

HOUSTON, TEXAS  
FAX: (800) 824-5559 (USA & Canada)  
FAX: (713) 688-6324  
PHONE: (713) 688-5533  
[www.liftmoore.com](http://www.liftmoore.com)

## CRANE SAFETY RULES

### CAUTION!

1. READ AND UNDERSTAND OPERATOR'S MANUAL.
2. INSPECT VEHICLE AND CRANE, INCLUDING ITS OPERATION BEFORE DAILY USE.
3. USE THIS EQUIPMENT ONLY ON SOLID LEVEL GROUND WITH OUTRIGGERS OR JACKSTANDS PROPERLY SET.
4. BEFORE OPERATING THE CRANE REFER TO MAXIMUM LOAD CHART ON CRANE FOR OPERATING LOAD LIMITS.
5. BE SURE LOAD BEING LIFTED IS WITHIN SAFE WINCH CAPACITY AS WELL AS SAFE CRANE CAPACITY. MULTI-PART LINE OPERATION IS REQUIRED WHEN SINGLE LINE LOAD CAPACITY OF WINCH IS EXCEEDED.
6. DO NOT OPERATE, WALK, OR STAND UNDER THE BOOM OR ANY SUSPENDED LOAD.
7. ALWAYS PAY OUT LOAD LINE BEFORE EXTENDING BOOM. WIRE ROPE DAMAGE AND / OR BREAKAGE MAY OCCUR.
8. BOOM MUST BE IN ITS REST BEFORE MOVING VEHICLE.
9. BOOM TIP MUST BE DIRECTLY OVER THE LOAD BEFORE ANY LIFTING IS STARTED. DO NOT DRAG LOADS WITH THIS CRANE.
10. MAINTAIN THIS CRANE AS REQUIRED IN THE OWNER'S MANUAL.
11. DO NOT ALLOW PERSONNEL TO RIDE ON THE LOAD LINE, LOAD, OR BOOM OF THIS CRANE.
12. IT IS UNLAWFUL TO OPERATE THIS EQUIPMENT WITHIN TEN FEET OF HIGH VOLTAGE LINE



F1122-B  
05/12/08

HOUSTON, TEXAS  
FAX: (800) 824-5559 (USA & Canada)  
FAX: (713) 688-6324  
PHONE: (713) 688-5533  
[www.liftmoore.com](http://www.liftmoore.com)

THIS PAGE INTENTIONALLY LEFT BLANK



F1122-B  
05/12/08

HOUSTON, TEXAS  
FAX: (800) 824-5559 (USA & Canada)  
FAX: (713) 688-6324  
PHONE: (713) 688-5533  
[www.iftmoore.com](http://www.iftmoore.com)

## INTRODUCTION

This crane is a powerful machine designed to lift and move heavy loads. There are many hazards associated with these operations. Liftmoore has designed this crane to be as safe as possible but -

### IT IS THE OPERATOR'S RESPONSIBILITY TO PREVENT ACCIDENTS!

This takes pre-planning, attention, and knowledge of basic principles and rules. Even if you have used similar cranes, reading this manual in its entirety will help prevent damage, injury, or even loss of life; benefits well worth the short amount of time it takes to read these pages.

### REGULATORY AUTHORITY

Use of this crane is governed by OSHA 29 CFR 1910.180 and may be governed by other federal, state, or local regulations.

IT IS THE OPERATOR'S RESPONSIBILITY TO UNDERSTAND AND COMPLY WITH ALL APPLICABLE REGULATIONS GOVERNING THE OPERATION, INSPECTION, AND MAINTENANCE OF THIS CRANE.

Personnel should be trained, tested, and certified, as recommended by OSHA and ANSI standards, before operating this crane.

### USING THIS MANUAL

This manual assumes that the crane is mounted on a typical service body type or similar truck, which is powered by the vehicle electrical or hydraulic system, and is controlled by either the standard pendant control or FM radio control sold by Liftmoore, Inc.

This manual is supplied to provide basic guidelines for the safe use, routine maintenance, and general inspections of this crane.

This manual is supplied to provide basic guidelines for the safe use, routine maintenance, and general inspections of this crane.

Laws, regulations, standards, or policies may be more restrictive than this manual. If a conflict exists for any limit or condition, the safest or most prohibitive shall be used. Under no circumstances shall the load, moment, or stability ratings be exceeded.

Pay particular attention to the following:

**WARNING!** – Draws attention to hazards, conditions, or procedures that if not observed could result in injury or death.

**CAUTION!** – Draws attention to hazards, conditions, or procedures that if not observed could result in damage to the crane, load, or other equipment. Equipment failure could in turn lead to injury or death.

**NOTE!** – Draws attention to conditions or procedures that are essential to emphasize.

For questions, interpretations, or to report errors, please contact Liftmoore, Inc, Engineering Dept.



## OPERATING RESTRICTIONS

### DUTY CYCLE

For Electric Cranes the duty cycle time should be limited to 10%. This is limited by heat buildup in the motors and declining charge in the batteries. (Installing extra batteries near the crane helps keep the voltage at maximum.) (applies to Electric pump and winch only)

### PERSONNEL

LIFTING OR MOVING OF PERSONNEL IS STRICTLY PROHIBITED! This crane was neither designed nor intended to lift personnel. Under no circumstances should anyone be allowed to ride on the crane, line, or load. All non-essential personnel must be kept away when using the crane. The load must never be moved over people, nor must anyone be allowed to pass or stand under a suspended load.

### ELECTRICAL LINES

Consult ANSI B30.5 for operating procedures, minimum safe distances, and prohibited zones when working around electrical lines or poles.

When operating near electrical power lines, the crane must be positioned so that the distance from the crane to the lines or poles is equal to or greater than the length of the fully extended boom plus the minimum safe distance required.

All parts of the crane, line, and load must be kept a minimum safe distance from electrical power lines and poles. This distance is 10 feet for electrical lines carrying 50kV or less.

**UNDER NO CIRCUMSTANCES SHOULD A CRANE BE OPERATED UNDER ELECTRICAL POWER LINES.**

### REQUIRED CLEARANCE FOR NORMAL VOLTAGE IN OPERATION NEAR HIGH-VOLTAGE POWER LINES AND OPERATION IN TRANSIT WITH NO LOAD AND BOOM OR MAST LOWERED

Normal Voltage, kV (phase to phase)	Minimum required Clearance ft (m) [note (1)]
Operation Near High Voltage Power Lines	
Up to 50	10 (3.05)
Over 50 to 200	15 (4.60)
Over 200 to 350	20 (6.10)
Over 350 to 500	25 (7.62)
Over 500 to 750	35 (10.67)
Over 750 to 1,000	45 (13.72)
Operation in Transit With no Load and Boom or Mast Lowered	
Up to 0.75	4 (1.22)
Up to 0.75 to 50	6 (1.83)
Up to 50 to 345	10 (3.05)
Up to 345 to 750	16 (4.87)
Up to 750 to 1,000	20 (6.10)

#### NOTE:

- (1) Environmental conditions such as fog, smoke, or precipitation may require increased clearances.

## OPERATING PRACTICES

### SETUP

**POSITION** The vehicle must be positioned so that the load is kept as close to the crane base as possible to reduce the moment on the crane. Consideration must be given to starting and ending position as well as firmness and slope of the ground and any obstructions.

**OUTRIGGERS** The outriggers or jackstands must be firmly set and the vehicle as level as possible. This will reduce the stresses on the rotation drive and keep the load off the vehicle's suspension. Keep in mind that the weight on the vehicle will shift as the crane and load is rotated.

**MANUAL BOOM EXTENSION** If the manual extension part of the boom is



needed, it must be extended and the boom pin placed in the required position. Insert the pin and replace the pin's hairpin keeper before attempting to lift any load.

**LOAD LIMIT** The operator must understand the crane load chart. The operator must ensure that the load is within the load limits over the entire range which it will be moved. Be sure to include the weight of any lifting devices including the travel block.

The load limit chart is attached to the side of the crane to aid the operator.

The boom angle indicator and chart aids the operator in determining the load capacity at various boom angles and extensions. It also gives the load limit at that configuration.

**STABILITY** A stability chart must be posted near the crane. The operator must understand the stability chart. The crane may be de-rated over some areas of its operating radius.

**TRAVEL BLOCK** The operator must determine if the load is within the single line compatibility of the winch or if a multi-part line configuration is needed.

**REEVING** Ensure the proper routing of the rope through the sheaves and travel block. The rope must lie in the sheave groove and must not rub against any metal objects.

Ensure the rope is correctly wound on the winch drum. The crane assembly drawing will indicate if the rope must be wound over the top or bottom of the drum. The rope must never contact any part of the winch mounting.

### **WARNING!**

If the winch winding direction is reversed the brake will not work and the load will fall.

## **ATTACHING THE LOAD**

**POSITION** The boom tip must be moved over the load before lifting so that it will be lifted straight up.

### **CAUTION!**

Never drag a load with the crane. Dragging a load puts very high stresses on the crane for which it was not designed.

**ROPE** Check the rope condition to ensure it is not frayed or damaged. Ensure that the rope is not kinked and that it does not contact any sharp edges or make any sharp bends.

If using double line configuration, ensure that the lines are not twisted.

### **CAUTION!**

Never wrap the hoist rope around the load! Serious damage to the rope WILL occur.

**HOOK** Always make sure the load is applied to the throat of the hook. Never use a bent hook.

### **CAUTION!**

Always lift with the throat of the hook. Never lift with the load applied to the tip of the hook. Doing so will bend the hook.

**SLINGS** If the load does not have a lifting eye, use a nylon, chain, or other type of sling designed for lifting and rated for loads greater than that being lifted.

**BALANCE** Ensure the load will be secure and balanced when lifted. Ensure that the load cannot shift in the sling and that the sling cannot slide across the hook should the load become unbalanced.



1-6

### **LIFTING THE LOAD**

Before lifting, ensure that the load is free from all mountings and is no way attached or stuck to anything.

Ensure that at least five full wraps remain on the winch drum at all times.

Test the winch brake by lifting the load a few inches and ensuring that it does not slip.

### **HOLDING THE LOAD**

The operator must keep the load in sight at all times once it is lifted.

The operator must never leave the controls once the load is lifted.

The operator must ensure that no one is allowed to pass or stand under a suspended load.

### **CAUTION!**

Never move the vehicle with a suspended load. Doing so will put dynamic loads on the crane for which it was not designed.

### **MOVING THE LOAD**

Before moving the load, make sure the path is free of any obstructions or people.

Avoid sudden accelerations or stops. Speeds must be kept to a minimum, especially rotation, to keep the load from swinging.

Avoid sudden reversing of direction. Do not reverse direction while the load is still moving.

Make sure that no part of the crane, boom, or load makes contact with any obstruction or comes within a minimum of ten feet from any electrical line.

### **TRANSIT**

While in transit, the crane must be stowed, preferably in a boom rest. The crane must be prevented from rotating and the hook prevented from swinging.







F1112-F  
7/5/12



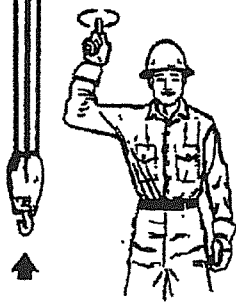
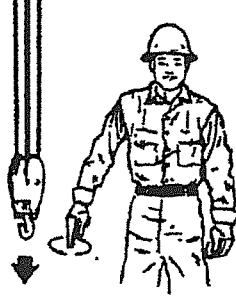

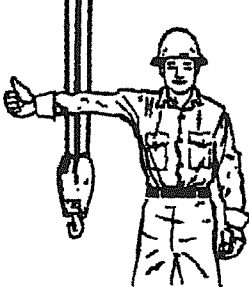
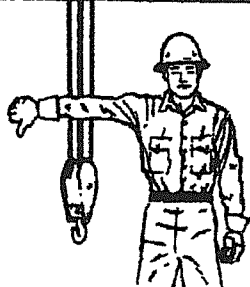

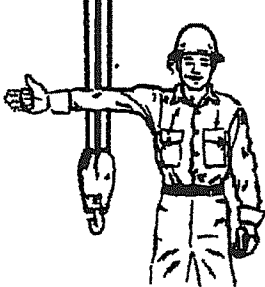
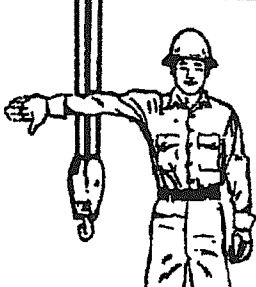
HOUSTON, TEXAS  
FAX: (800) 824-5559 (USA & Canada)  
FAX: (713) 688-6324  
PHONE: (713) 688-5533  
[www.liftmoore.com](http://www.liftmoore.com)

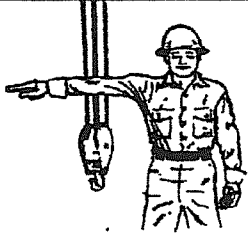
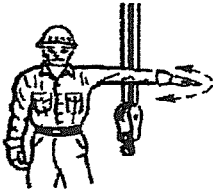

**Standard Hand Signals for Controlling Crane Operations**

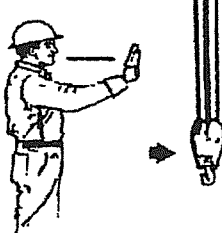
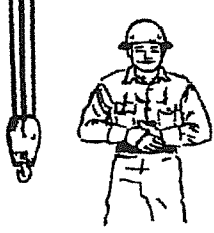
 <p><b>HOIST.</b> With forearm vertical, forefinger pointing up, move hand in small horizontal circle.</p>	 <p><b>LOWER.</b> With arm extended downward, forefinger pointing down, move hand in small horizontal circle.</p>	 <p><b>USE MAIN HOIST.</b> Tap flat on head; then use regular signals.</p>
 <p><b>USE WHIPLINE (Auxiliary Hoist).</b> Tap elbow with one hand; then use regular signals.</p>	 <p><b>RAISE BOOM.</b> Arm extended, fingers closed, thumb pointing upward.</p>	 <p><b>LOWER BOOM.</b> Arm extended, fingers closed, thumb pointing downward.</p>
 <p><b>MOVE SLOWLY.</b> Use one hand to give any motion signal and place other hand motionless in front of hand giving the motion signal. (Hoist slowly shown as example.)</p>	 <p><b>RAISE THE BOOM AND LOWER THE LOAD.</b> With arm extended, thumb pointing up, flex fingers in and out as long as load movement is desired.</p>	 <p><b>LOWER THE BOOM AND RAISE THE LOAD.</b> With arm extended, thumb pointing down, flex fingers in and out as long as load movement is desired.</p>

Standard Hand Signals for Controlling Crane Operations (Cont'd)

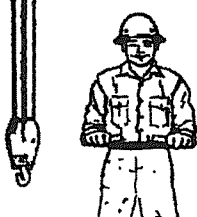
 <p><b>SWING.</b> Arm extended, point with finger in direction of swing of boom</p>	 <p><b>STOP.</b> Arm extended, palm down, move arm back and forth horizontally</p>	 <p><b>EMERGENCY STOP.</b> Both arms extended, palms down, move arms back and forth horizontally.</p>
 <p><b>TRAVEL.</b> Arm extended forward, hand open and slightly raised, make pushing motion in direction of travel.</p>	 <p><b>DOG EVERYTHING.</b> Clasp hands in front of body.</p>	 <p><b>TRAVEL (Both Tracks).</b> Use both fists in front of body, making a circular motion about each other, indicating direction of travel, forward or backward. (For land cranes only.)</p>
 <p><b>TRAVEL (One Track)</b> Lock the track on side indicated by raised fist. Travel opposite track in direction indicated by circular motion of other fist, raised vertically in front of body. (For land cranes only.)</p>	 <p><b>EXTEND BOOM (Telescoping Booms).</b> Both fists in front of body with thumbs pointing outward.</p>	 <p><b>RETRACT BOOM (Telescoping Booms).</b> Both fists in front of body with thumbs pointing toward each other.</p>



HOUSTON, TEXAS  
 FAX: (800) 824-5559 (USA & Canada)  
 FAX: (713) 688-6324  
 PHONE: (713) 688-5533  
 www.liftmoore.com

### Standard Hand Signals for Controlling Crane Operations (Cont'd)

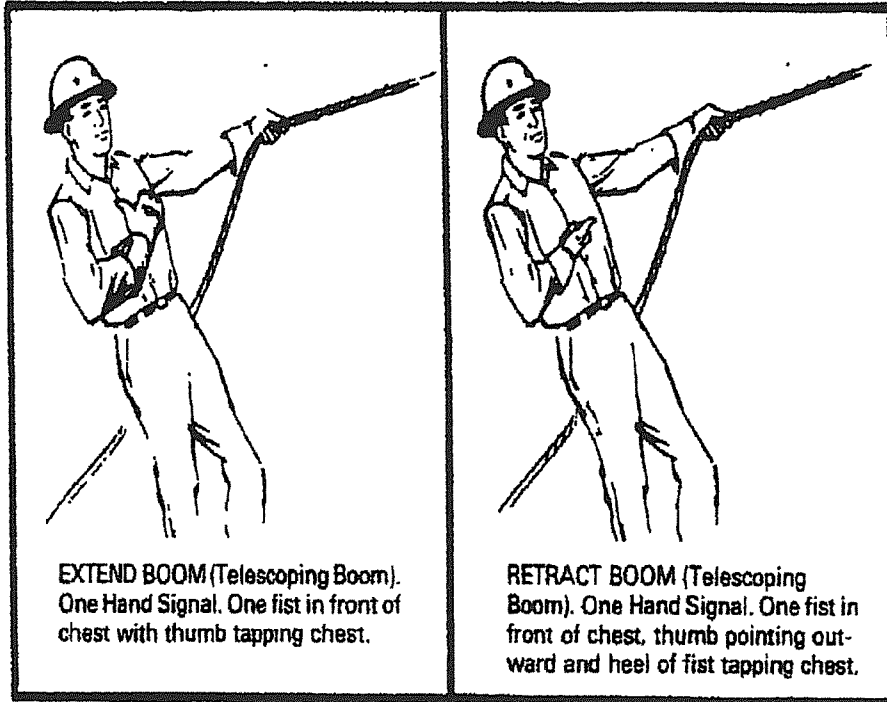

HOUSTON, TEXAS  
FAX: (800) 824-5559 (USA & Canada)  
FAX: (713) 688-6324  
PHONE: (713) 688-5533  
[www.liftmoore.com](http://www.liftmoore.com)

## INSPECTION AND MAINTENANCE

OSHA and ANSI require frequent and periodic inspections. Records of these inspections must be kept readily available. Liftmoore requires periodic maintenance to ensure proper operation and prolonged life of the crane.

### INSPECTION

#### DAILY INSPECTION

OSHA 29CFR 1910.180 (d)(2)(i) requires the following be checked daily prior to use:

- All control mechanisms for maladjustment interfering with proper operation as well as for excessive wear of components and contamination by lubricants or other foreign matter.
- All safety devices for malfunction. This should include the anti-two block and pressure switch.
- Deterioration or leakage in air or hydraulic systems.
- Crane hooks with deformations or cracks. For hooks with cracks or having more than 15 percent in excess of normal throat opening or more than 10 deg. twist from the plane of the unbent hook.
- Electrical apparatus for malfunctioning, signs of excessive deterioration, dirt, and moisture accumulation. This should include the battery terminals, master disconnect switch, electrical swivel
- The wire rope shall be replaced if any of the following conditions are noted:

- Kinking, crushing, bird-caging, or other damage
- Reductions from nominal diameter of more than one-sixty-fourth inch for diameters up to and including five-sixteenths inch, one-thirty-second inch for diameters three-eighths inch to and including one-half inch.
- Thimble is not in place or is damaged
- Any evidence of heat damage
- Six or more randomly distributed broken wires in 1 lay
- Three or more broken wires in 1 strand in 1 lay

#### MONTHLY INSPECTION

A thorough inspection of all ropes in use shall be made at least once a month and a certification record which includes the date of inspection, the signature of the person who performed the inspection and an identifier for the ropes shall be prepared and kept on file where readily available. All inspections shall be performed by an appointed or authorized person. Any deterioration, resulting in appreciable loss of original strength shall be carefully observed and determination made as to whether further use of the rope would constitute a safety hazard. Some of the conditions that could result in an appreciable loss of strength are the following:

- Reduction of rope diameter below nominal diameter due to loss of core support, internal or external corrosion, or wear of outside wires.
- A number of broken outside wires and the degree of distribution of concentration of such broken wires.



- Worn outside wires.
- Corroded or broken wires at end connections.
- Corroded, cracked, bent, worn, or improperly applied end connections.
- Severe kinking, crushing, cutting, or unstranding.

#### PERIODIC INSPECTION

An Annual Inspection Form is included in this manual. OSHA 29CFR 1910.180 (d)(2)ii) requires periodic inspections of this crane. Liftmoore recommends an annual inspection using the included form.

#### MAINTENANCE PRECAUTIONS

The crane should be maintained monthly for safety reasons and to reduce stress on the crane.

#### WARNING!

Never perform any maintenance while the crane has any type of load on it. Use the manual operation procedure to lower the load if necessary.

#### WARNING!

Hydraulic cylinders may have high pressure stored in them even after hydraulic power is removed.

The counterbalance and pilot operated check valve in the cylinder will always hold some pressure in the cylinder. Slightly extending the cylinder then retracting a small amount will relieve most of the pressure in the cylinder. **DO NOT DEADHEAD THE CYLINDER!** This will store the maximum amount of pressure in the cylinder. Care should be taken when either valve is removed from the cylinder as some pressure will still remain.

After any maintenance has been performed the crane shall not be operated until all guards have been reinstalled, all safety

devices reactivated, and maintenance equipment removed.

**LUBRICATION** Refer to the crane specification section for the periodic maintenance schedule and type of lubrication required.

**BOLTS** Bolts may loosen over time due to vibration; therefore they should be checked periodically. If bolts need to be replaced, make sure they are replaced with bolts of equal or greater strength. Check the periodic maintenance schedule (Crane Specification Section) for bolt specification and torque.

#### NOTE!

Sheave and boom and cylinder pivot bolts are not standard bolts. The shank and thread length of these bolts have been modified so that they do not pivot on the threads. Consult the parts section of this manual for part numbers of these bolts.

#### OTHER MAINTENANCE

Refer to parts drawings for any specific maintenance or adjustment procedures such as hydraulic winch brake, rotation drive gear set adjustment, Ect.



## MONTHLY INSPECTION REPORT

Crane Model No. \_\_\_\_\_ Serial Number \_\_\_\_\_

- |  |           |          |
|--|-----------|----------|
| Are Boom Hitch Pins and Keepers in place?                              | Yes _____ | No _____ |
| Wire Line Hook with Safety Latch Working?                              | Yes _____ | No _____ |
| Is Hook OK, (Not bent)?  | Yes _____ | No _____ |
| Is Thimble on Wire Rope OK?  | Yes _____ | No _____ |
| Is Traveling Block in use?   | Yes _____ | No _____ |
| Is Wire Rope OK, not kinked or frayed?                                 | Yes _____ | No _____ |
| Are all Boom Sections straight?  | Yes _____ | No _____ |
| Are Sheave Bolts in place and tight?                                   | Yes _____ | No _____ |
| Do all Sheaves rotate easily?  | Yes _____ | No _____ |
| Are Mounting Bolts tight?  | Yes _____ | No _____ |
| Is Anti Two-Block functioning properly?                                | Yes _____ | No _____ |
| Is Boom Angle Indicator in place and functioning and is Chart legible? | Yes _____ | No _____ |
| Are Cylinder Mounting Bolts secure?                                    | Yes _____ | No _____ |
| Are Winch Mounting Bolts tight?  | Yes _____ | No _____ |
| When stopped does winch drift less than 1.0 Inches?                    | Yes _____ | No _____ |
| Is Load Chart in place and easily read?                                | Yes _____ | No _____ |
| Are functions on Pendant operating correctly?                          | Yes _____ | No _____ |
| Is Hydraulic Reservoir full?   | Yes _____ | No _____ |
| Is Outrigger straight and functioning?                                 | Yes _____ | No _____ |

Any items checked 'No' must be repaired before using this crane.



## ANNUAL CRANE CERTIFICATION (29CFR1910.180)

OWNER \_\_\_\_\_

MODEL NUMBER \_\_\_\_\_ SERIAL NUMBER \_\_\_\_\_

DATE \_\_\_\_\_

Check the following:

 Crane Mounting Bolts (Torque) Winch mounting Bolts (Torque) Boom mounting bolts Cylinder mounting bolts Cracks on boom (Check when extended) Extension Pads not worn excessively Cracks on housing Weld cracks on boom Weld cracks on housing Boom swing approximately one inch or less at boom tip when retracted Hydraulic leaks Hoses not chafed or cracked

Sheaves not cracked

 Boom Tip Traveling Block Sheaves not worn excessively Boom Tip Traveling Block Sheaves rotate freely Boom Tip Traveling Block

*Load Chart in place and legible*

*Boom angle chart in place and legible*

*Labels in place (See manufacturer's chart)*

*Crane Hook Throat Opening within 15% of standard*

*Crane Hook not bent more than 10 degrees from plane*

*Hook safety latch operating properly*

*Booms pin(s) and Keeper(s) in place (Manual Extension Section)*

*Wire Rope removed if the following occurs:*

*Six randomly distributed broken wires in one lay or three broken wires in one strand in one lay.*

*Wear of one-third the original diameter of outside individual wires.*

*Kinking, crushing, bird-caging or any other damage.*

*Evidence of heat damage.*

*Reduction from nominal diameter of more than one sixty-fourth inch for diameters to five-sixteenths diameter and one-thirty-second inch for diameters three-eighths to one-half inch.*

*Wire Line installed as manufacturer requires.*

*Protective covers in place*

*Grease crane as required*

*Check fluid level*

*Winch*

*Gearbox*

*Reservoir*



*Control system for proper operation*

\_\_\_ *Winch Up and Down*

\_\_\_ *Boom Up and Down*

\_\_\_ *Boom In and Out*

\_\_\_ *Rotation CW and CCW*

*Anti Two-Block (Required on Power Extendible Cranes) interrupts:*

\_\_\_ *Boom Down*

\_\_\_ *Boom Out*

\_\_\_ *Winch Up*

\_\_\_ *Boom Up stopped by Up Limit Switch*

\_\_\_ *Outrigger or jackstand operable*

\_\_\_ *Outrigger crushing decal in place*

\_\_\_ *Outrigger and Jackstand operates properly*

\_\_\_ *Boom rest in place and used*

\_\_\_ *Load Sensor trips when overloaded*

\_\_\_ *Winch Down does not overrun when stopped*

\_\_\_ *Crane stability chart in place and visible.*

*I certify that I have performed the above tests and that any deficiencies were corrected and now comply as above.*

*Signed* \_\_\_\_\_

*Print Name* \_\_\_\_\_

*Company* \_\_\_\_\_

*Address* \_\_\_\_\_

*City* \_\_\_\_\_ *State* \_\_\_\_\_

THIS PAGE INTENTIONALLY LEFT BLANK



HOUSTON, TEXAS  
FAX: (800) 824-5559 (USA & Canada)  
FAX: (713) 688-6324  
PHONE: (713) 688-5533  
[www.liftmoore.com](http://www.liftmoore.com)

## FM CONTROL SYSTEM

KTG – 4<sup>TH</sup> Generation KTFM (Hall Effect Trigger)

The Liftmoore FM control system Model KTG is a microprocessor-based radio/CAN remote control system. It allows the operator to control the crane using FM radio signals or the digital Control Area Network (CAN) protocol.

The standard system consists of a transmitter, crane receiver/control system, CAN cable, and a battery charger. For systems with engine control an additional engine control receiver is included.

### RECEIVER

The crane receiver is a self-contained control system. It contains the FM receiver, limiting system, and proportional valve driver (for proportional control cranes only). It receives power and safety circuit inputs (ATB and load sensor) from the crane. User inputs are received from the transmitter by FM radio signals or through the CAN cable. A green signal reception LED (light) and a red error code LED are provided for user diagnostics.

Error codes are indicated by counting the flashes of the red error code LED. The number of flashes represents the error code listed on the front of the receiver.

### NOTE!

Error Code 1, which appears as continual, steady blinking, will remain active until a signal is received.

### TRANSMITTER

The transmitter is a hand held unit which sends user input to the receiver by FM radio signals or by the CAN cable. Its features consist of an on/off push button switch, double acting momentary contact switches for each function, a 4 pin connector for attaching the CAN/charging cable, low battery light, and a transmit light.

For proportional control cranes a trigger is provided for speed control.

A Start/Stop toggle switch and an Engine High/Auxiliary toggle switch are provided for engine control. They work with the **optional** engine control receiver. If the crane was not ordered with this feature, it may be added. Contact your distributor or Liftmoore for more information.

### TRANSMITTER FLASHING LIGHTS CODES (lights located next to E-Stop button)

The green transmit light will flash any time a user input is being transmitted.

Red & green flashing Simultaneously: Load sensor tripped.

Red & green Flashing Alternately: Anti-Two Block (pickle weight) tripped.

### BATTERY AND CHARGING

The transmitter is powered by a NiMH battery or from the crane power source when attached to the CAN cable. Connecting the transmitter to the CAN cable also charges the battery. To conserve battery power the transmitter will turn itself off if idle for 1 hour.

When battery voltage drops below 9V the battery light will blink once every 30 seconds. As the battery voltage continues to drop the light will blink faster.

The Universal Guider (KTG) is designed with NiMH batteries, much more power, last longer and has a sensor. The Universal Guider is designed with smart charger which can charge a dead battery in couple hours and when the battery is charged it will shut off the charging and turn the battery light (on the bottom of pendant Green. This way it can be left on all the time. It also works on 12 and 24 volt systems.

Light at the Bottom of pendant (lights up when charger is connected)

**Red light means charging**

**Green light means charged.**

### COMPONENT

#### REPLACEMENT

Each transmitter is encoded with a digital ID that is programmed to its specific receiver.



F1882-0  
8/31/11

HOUSTON, TEXAS  
FAX: (800) 824-5559 (USA & Canada)  
FAX: (713) 688-6324  
PHONE: (713) 688-5533  
www.liftmoore.com

The receiver then only accepts signals from that transmitter so multiple cranes may be operated in the same vicinity without interference. If either component needs to be replaced, the receiver must be programmed to accept the new transmitter ID. This is easily done with a temporary wiring harness. Contact Liftmoore for more information.

#### Normal OPERATION

Turn on power to the crane and ensure the receiver is also receiving power.

Turn on the transmitter by holding the power button for at least a half of a second or until the power and transmit lights stop flashing. Note that when the flashing stops the green light will be on and remain on until the button is released.

Select a function and press the toggle switch in the desired direction as indicated on the label.

If the crane is a proportional control type, then SLOWLY squeeze the trigger after the function switch is activated.

#### NOTE!

If the trigger is pulled before a function switch is activated Error Code 7 will be active and the crane will not function. The trigger finger should remain off of the trigger until after a function is selected.

#### SPECIAL OPERATION

##### CHANNEL LOCKING

If excessive interference is experienced, the transmitter can be set to use only one frequency.

To lock a channel, turn off the transmitter power then hold HOIST DOWN and ROTATION CCW while turning the power on.

The Low Battery LED will blink several times. The number of flashes will indicate the channel number that it is locked on.

Channel Lock will remain active until the transmitter is turned off.

#### POWER ADJUSTMENT

The transmitter can be set at one of 4 power levels. Increasing the power will increase the range and reliability, but will decrease battery life.

To change the power setting activate and hold ENGINE SPEED and BOOM UP for 3 seconds. The red (Low Battery) LED will flash from 1 to 4 times to indicate the power level.

The power level will remain set until changed by the user, even if the transmitter is turned off.

#### ENGINE CONTROL (OPTIONAL)

If the FM system was ordered with the engine control option an engine control receiver will be included, if not it may be ordered separately. Contact your distributor or Liftmoore for more information.

#### TRANSMITTER

Both engine control switches are double acting momentary toggle switches. One controls start and stop and the other controls high idle and an auxiliary function.

#### RECEIVER

Both the start and stop output signals are momentary, i.e. the output signal is on only when the switch is held.

The auxiliary output is maintained. When the switch is pressed the signal toggles, i.e. the first time the switch is activated the signal turns on, the second time it is activated the signal turns off.

The high idle signal can be set up as either maintained or momentary as needed. If a positive voltage is supplied to pin 5 then the output is momentary, otherwise the output is maintained.



## OPTIONAL ENGINE CONTROL RECEIVER INSTALLATION

The engine control functions allow the user to start and stop the engine and also advance the idle, all from the crane remote pendant control.

The following instructions provide a general guideline for installing and wiring the receiver. Since engine controls vary from manufacture to manufacturer and even from year to year, it is impossible for Liftmoore to maintain specific information on your vehicle. You will have to contact the vehicle and/or engine manufacturer (contact information is provided below). Also, many new vehicles have a provisions for remote engine control built into the ECU, but these functions must be activated and/or programmed buy a dealer or authorized service center.

### MOUNTING THE RECEIVER

The receiver should be mounted vertically with the antenna up. For best reception, it should be mounted in line of site of operator. Since interfacing connections will generally be inside the cab, a good mounting place is the inside, back the cab with the antenna visible though the back glass. The receiver can be mounted outside of the cab, however it should NOT be mounted inside the engine compartment because of interference generated by the engine.

### ENGINE START

Engine start is accomplished by splicing the brown wire on the engine receiver control harness with the ECU start circuit.

### WARNING!

Engine start may bypass some manufactures safety functions such as clutch or neutral interlock. It is the installer's responsibility to ensure safe and proper installation.

### ENGINE STOP

If the ECU is not equipped with a remote engine kill circuit then a normally closed relay must be installed in the ECU power or engine run circuit. The gray wire on the engine control receiver harness is then connected to the solenoid coil. Activating the circuit will open the solenoid, killing the engine.

### NOTE!

It is advisable to include a small jumper wire that can be installed to bypass the solenoid should it fail, otherwise the engine would not run.

### ADVANCED IDLE

Many new diesel engines have an advanced idle control circuit built into to the ECU. Some automatically advance the idle when the PTO is activated. This feature may have to be activated and/or programmed by the dealer.

### NOTE!

Some engines also require activating a PTO circuit to prevent "Service Engine Soon" or other erroneous errors during PTO operation.

For gas engines or engines without this feature, an after-market throttle advance will have to be purchased separately.

## CONTACT INFORMATION

Your truck or engine dealer should be able to provide you with further assistance. Also check the manufacturer's body builder manual (some provided online). Before calling, please have your vehicles make, model, year, engine size and manufacturer, and VIN if available.

Ford Body Builders Advisory Service	1.877.840.4338
GM Upfitter Integration	1.800.875.4742
Peterbilt	1.940.591.4000
Caterpillar	1.800.847.4986
Cummins	1.800.343.7357

[www.fleet.ford.com/truckbbas](http://www.fleet.ford.com/truckbbas)  
[www.gmupfitter.com](http://www.gmupfitter.com)

## SAFETY SYSTEM

The safety system is designed to help prevent damage to the crane that would be caused by overload or two-blocking. The system consists of a load sensor, anti-two block device (optional on smaller, electric cranes), and limiting system control board.

When the applicable switch detects an overloading or two-block condition, the limiting system will prevent activation of winch up, and extend out since these directions would cause damage. Winch down, boom down, boom up, extend in, and power rotation will still function so that the crane can be moved to a safe configuration.

### CAUTION!

Never de-activate or override safety functions. Doing so can result in serious damage to the crane and possibly injury or death.

### LOAD SENSOR

A pressure activated switch in the elevation cylinder acts as a load sensor. This switch is normally closed and opens at the preset pressure corresponding to the load rating of the crane.

### CAUTION!

The load sensor will not function when the elevation cylinder is fully retracted and is inaccurate when the boom is below horizontal.

### CAUTION!

The operator must never rely strictly on the load sensor to determine overload conditions. The load and load limits must always be known and adhered to.

### ANTI-TWO BLOCK

The anti-two block device (optional on smaller electric cranes), mounted on the boom crown plate, consists of a normally open switch actuated by a lever. A weight is attached to the lever and holds the switch

closed. If the weight is lifted by the hook or travel block the switch opens.

The power and signal wires are wired through the cord reel, which is in turn wired to the ATB switch.

## LIMITING SYSTEM CONTROL

Two systems are included to limit crane overloads and wire rope breakage. When a crane overload occurs, the load sensor will stop winch up, extension out and boom down. To prevent breaking the wire rope, the Anti Two-Block device stops winch up and extension out when either is engaged.

The capacity of boom up is limited by the pressure setting of the relief valve in the manifold.

There is a one second delay before the deactivation of boom down when the load sensor is tripped to prevent false readings caused by pressure spikes.

## MISCELLANEOUS

### UP LIMIT SWITCH

The up limit switch prevents the elevation cylinder from reaching full extension. If the elevation cylinder were to "dead-head", the resulting pressure would activate the load sensor, preventing boom down. The boom would then have to be lowered using the manual operation buttons on the solenoid valves.

### CIRCUIT BREAKER, FUSE

For electric cranes a 150 Amp circuit breaker is supplied with the crane. It should be installed as close to the battery as possible. For hydraulic cranes a 10 Amp blade type fuse is supplied.

### DISCONNECT SWITCH

A power disconnect switch is supplied with the crane. Power to the crane should be turned off whenever not in use. This is to prevent inadvertent or unauthorized use and will help prevent corrosion at electrical connections.



## HYDRAULIC SYSTEM

Sterling HYD Proportional

The hydraulic system consists of the hydraulic swivel, manifold with solenoid valves, and actuators (cylinders, motors) Hydraulic power is received from an external hydraulic source, typically a PTO driven pump attached to the vehicle transmission. The hydraulic manifold is plumbed in series and uses open center valves so that more than one function can be operated simultaneously.

### SWIVEL

The hydraulic swivel is a two-port swivel that allows continuous, unlimited rotation. Refer to drawing for more information.

### MANIFOLD

The hydraulic manifold contains the system relief valve, proportional flow control valve, and a directional control valve for each function.

The system relief valve prevents damage that would be caused by over pressurizing the system. It is a cartridge type valve located at the pump port of the manifold. Factory setting is 3000PSI.

The proportional valve is an electrically operated flow control valve. Regulated flow is directed to the manifold while excess flow is returned to tank. Before activation, all flow is returned directly to tank, minimizing heat build up. During operation the flow is regulated proportionally to the input voltage<sup>(1)</sup> allowing the operator to control the speed of the crane. The valve cracks at approximately 2V and allows approximately

### MANUAL VALVE OPERATION

If electrical problems occur the proportional valve and function valves may be operated

7GPM at 6V. A screw on top of the valve is used to manually operate the valve.

(1) Technically, flow is directly proportional to amperage. Since the resistance is essentially constant, voltage is proportional to amperage. Within the accuracy required for this application, it can be said that the flow is directly proportional to the voltage

Each hydraulically operated function is controlled by a 4 way, 3 position open center solenoid valve. It is electrically operated and spring biased to center. A manual operation feature is also incorporated.

### CYLINDERS

Hydraulic cylinders are double acting cylinders with integrally mounted counterbalance valves. This valve performs 3 functions:

- Controls the rate of decent when lowering the load
- Keeps load from falling in the event of sudden loss of system pressure, such as when a hose bursts.
- Acts as a relief valve to prevent damage from induced load or thermal expansion.

It allows free flow to extend, then blocks flow until opened by pilot pressure to the retract port or when the relief pressure is reached.

Some cylinders utilize a pilot operated check valve on the retract port to prevent the cylinder from creeping out under no load conditions. This valve allows flow into, but prevents flow from the retract port, thus hydraulically locking the cylinder until opened by pilot pressure to the extend port.

manually. Refer to the manifold drawing for valve location and directions.

To operate the crane, both the function valve and the proportional valve must be opened. If only the proportional system is not



functioning, it will be easiest to manually set the proportional valve and operate the function with the pendant control. If the functions are not operating, it will be easiest to operate both the function valves and proportional valve manually.

To operate the function valves, pull the locking collar back to unlock it. The manual operation button may then be pushed or pulled depending on desired direction. The valve is spring bias to center so the function will stop when the manual operation button is released.

The proportional valve must also be opened for the crane to operate. It uses a screw type manual override that allows precise control of the speed. To set, operate a function valve, then turn knurled knob on the proportional valve counter-clockwise until the crane begins moving. Adjust until the desired speed is reached. When finished be sure to reset the valve by screwing the knob all the way in (clockwise).

**CAUTION!**

If the proportional valve is not reset the crane will operate without trigger input. This may result in unexpected motion of the crane, resulting in equipment damage or personal injury.

If hydraulic power is lost while a load is suspended, the load may be lowered by decreasing the setting on the counterbalance valve. This should only be done in extreme cases. The valve must be reset and tested before the crane is returned to normal use.

**WARNING!**

When the valve setting is decreased, the boom and cylinder may come down suddenly. Do not position yourself under the boom or position any part of your body between the cylinder and boom or between the cylinder and housing.

To decrease the setting, loosen the locknut on the valve, then **SLOWLY** turn the adjustment stem **CLOCKWISE** until the load begins to lower. Count the number of turns so that the valve can be immediately returned to its approximate setting.

Before the crane is returned to regular service, the valve must be precisely set and tested. Contact Liftmoore for exact setting and procedure information. The setting may be tested by lifting a known load near the moment rating.

**MANUAL LOWERING OF LOAD**

**WARNING!**

The following procedure should be used in extreme cases only. Improper application of this procedure could result in injury or death.

**WARNING!**

The following procedure requires adjusting a safety valve. If the valve is not returned to the correct setting it may fail to hold a load, resulting in injury or death.





## BASIC TROUBLESHOOTING

The following chart gives a quick reference to help identify and correct problems. Refer to the following pages for more detailed information.

PROBLEM	PROBABLE CAUSE	CORRECTIVE ACTION	
NO FUNCTIONS WORK	<p>Not receiving electrical power</p> <p>Not receiving hydraulic power</p> <p>Control problem</p>	<p>Check all connections Check all fuses and circuit breakers Check for electrical power at first electrical connection and trace back to crane</p> <p>Check flow from pump Deadhead cylinder and check pressure at pump</p> <p>See control section</p>	
FUNCTION NOT WORKING	<p>winch up, extension out not working</p> <p>Boom down, winch down, extension in not working</p> <p>Other function not working</p>	<p>No signal from ATB or Load sensor (switch tripped, bad switch, bad wiring or not receiving power)</p> <p>Relay card malfunction</p> <p>Not receiving enough pressure</p> <p>Faulty wiring</p> <p>Valve coils bad</p>	<p>Check input signal to relay board if no signal, trace back to switch</p> <p>Check LEDs on board for error codes and outputs</p> <p>Deadhead cylinder and check pressure at pump</p> <p>Check differential pressure valve for contamination</p> <p>Check relief valve for proper setting and possible contamination</p> <p>Check all wiring for breaks or shorts Check all ground wires for good connection</p> <p>Check coil resistance</p>
ALL FUNCTIONS SLOW	<p>Not receiving enough flow</p> <p>Low battery voltage Check with engine running</p> <p>* Proportional valve problem</p> <p>* Control problem</p>	<p>Check fluid levels Check all filters and any other restrictions</p> <p>Charge battery (BATTERY MAY BE BAD)</p> <p>Try manual operation of proportional valve</p> <p>Check voltage at valve for approx. at min and max(see troubleshooting form for specific valves)</p> <p>See control section</p>	



F1774-0  
11/02/10

HOUSTON, TEXAS  
FAX: (800) 824-5559 (USA & Canada)  
FAX: (713) 688-6324  
PHONE: (713) 688-5533  
www.iftmoore.com

## TROUBLESHOOTING SAFETY SYSTEM

DTCH Relay Card

To check functions controlled by the safety system check the status indicators. (See Relay Box Assembly drawing.) If only one of the safety functions is not working, activate that function and check for error codes and/or its output status indicator.

For non-FM systems, if the status indicator lights then the problem is in the wiring or in the solenoid coil. If the light does not illuminate, check the control pendant. If the control pendant is good then the crane control module needs to be replaced.

For FM systems, check for error codes. If none are present, see the FM Troubleshooting section.

If boom out, boom down and winch up are not working, confirm that the control board has power. Confirm that the board is receiving a signal from the ATB and load sensor.

If the error code is active, ensure that the crane is not overloaded and that the ATB lever is holding the switch closed. Check for voltage at the ATB and Load Sensor inputs.

### CHECK LOAD SENSOR SWITCH

If the load sensor input is not receiving voltage, locate the load sensor connector inside the crane housing. The plug side will have a red wire and a gray wire, the receptacle side will have a red and a white wire.

Disconnect and check for continuity between the two pins on the receptacle (switch side). If there is no continuity then the load sensor is bad and needs to be replaced.

### CHECK ATB SWITCH

If the ATB input is not receiving voltage remove the ATB housing cover and disconnect the connector. Check for continuity on the switch side. Lifting the weight should break the continuity. If either of these conditions is incorrect the switch is bad and needs to be replaced.

### CHECK CORD REEL

Check the ATB switch if not done so already. Locate the ATB connector inside the crane housing. The plug side will have a red wire and a black wire. The receptacle side will have a white wire and a black wire.

Disconnect the plug going to the switch. Check for continuity between the two pins on the receptacle. Have someone lift the weight on the ATB and continuity should be broken. If either of these conditions are incorrect then the cord reel is bad and needs to be replaced.

### CHECK POWER TO SAFETY SWITCHES

If the safety switch is good, check for voltage at pin 1 (the red wire) on the plug. If there is no voltage, follow the wire back to the 6-pin power distribution plug, checking for breaks or shorts.

Remove the power distribution receptacle (cap).

### NOTE!

Removing the cap will disconnect power to all electrical components. Be sure to replace the cap before continuing.

Check the cap for bent pins. Check that all wires are fully seated in the plug. If they are not, then remove the green locking wedge and push the wires forward until seated. Reinstall the wedge ensuring that no wires are pushed back.



## TROUBLESHOOTING THE PROPORTIONAL SYSTEM

21398 HALL EFFECT, 12V Duplomatic Coil

If no functions work or if all functions are slow when controlled by the pendant, but work correctly when the manual operation button is pressed on the proportional valve then the problem is with the proportional electronic control system.

### Proportional Valve Parameters

Cracking voltage	2.6V
Full open voltage	7.75V
Coil Resistance	3.66Ω

### CHECK VOLTAGE AT VALVE

Have the engine running to generate sufficient voltage (13-14V). As the trigger is pulled the valve voltage should start near zero, jump to the valve cracking voltage after slight trigger travel, increase steadily as the trigger is pulled, reaching the full open voltage.

If the voltages are correct, check the resistance across the coil. If the resistance differs significantly from the nominal resistance replace the coil.



F1447-B  
7/23/12

HOUSTON, TEXAS  
FAX: (800) 824-5559 (USA & Canada)  
FAX: (713) 688-6324  
PHONE: (713) 688-5533  
[www.iftmoore.com](http://www.iftmoore.com)

## TROUBLESHOOTING FM CONTROL SYSTEM

Kar-Tech 21318

If the crane does not operate, ensure that both the transmitter and receiver are on. Try disconnecting power to the crane receiver then reconnecting.

Check that the green transmit light on the transmitter and the green receive light on the receiver light up when a function is selected.

When the red and green lights on the transmitter blink simultaneously, the pressure switch is overloaded, and the crane will not elevate down, extend out, and winch up. If the ATB is off, the red and green lights on the transmitter will blink alternately, and the crane will not elevate down and extend out.

Check for error codes and correct as necessary.

### NOTE!

Error Code 1 will be active until a signal is received, as indicated by the green light illuminating.

Check that all connectors are secure.

Check for bent pins on the receiver connectors.

If the crane still does not work, try using the CAN cable. If the system works with the CAN cable the problem may be that the batteries on the transmitter are low.

If unable to resolve the problem, please contact Liftmoore, Inc. for further information.

### ERROR CODE CHART

	PROBLEM
1	RADIO OR CAN SIGNAL PROBLEM
2	LOW ENGINE BATTERY
3	ATB SWITCH OFF
4	OVERLOAD (PRESSURE SW ON)
5	E-STOP BUTTON PUSHED
6	WRONG TRANSMITTER OR BAD ID
7	TRIGGER ON BEFORE FUNCTION SWITCH
8	TRIGGER PROBLEM
9	FAULTY CIRCUIT TO ROTATION CW
10	FAULTY CIRCUIT TO ROTATION CCW
11	FAULTY CIRCUIT TO EXTENSION OUT
12	FAULTY CIRCUIT TO EXTENSION IN
13	FAULTY CIRCUIT TO BOOM UP
14	FAULTY CIRCUIT TO BOOM DOWN
15	FAULTY CIRCUIT TO HOIST UP
16	FAULTY CIRCUIT TO HOIST DOWN
17	FAULTY CIRCUIT TO PROP OUPUT



## SECTION 3 CRANE SPECIFICATIONS

### MODEL 60100 CRANES

MOMENT RATING                      60000 FT-LBS

MAX SINGLE LINE LOAD            5 000 LBS  
MAX DOUBLE LINE LOAD          10 000 LBS

#### LIFTING CAPACITIES AT VARIOUS LOAD RADII

LOAD RADIUS (FT)	CAPACITY (LBS)
<6	10000
7	8571
8	7500
10	6000
12	5000
14	4286
16	3750
18	3333
20	3000
21	2857
22	2727
24	2500

#### POWERED FUNCTIONS AND EXPECTED TIMES

WINCH	UP: 14 s	DOWN: 16 s	1 REVOLUTION
BOOM ELEVATION	UP: 30 s	DOWN: 25 s	
BOOM EXTENSION	OUT: 54 s	IN: 44 s	
ROTATION	90° 11 s		

#### HYDRAULIC REQUIREMENTS

PRESSURE	2750 PSI
FLOW	6 GPM

#### ELECTRICAL REQUIREMENTS

VOLTAGE	12 VDC
FUSE	15 AMP

NOTE: FUNCTION TIMES ARE BASED ON THESE INPUT VALUES



F1757-0  
9/15/10

HOUSTON, TEXAS  
FAX: (800) 824-5559 (USA & Canada)  
FAX: (713) 688-6324  
PHONE: (713) 688-5533  
[www.liftmoore.com](http://www.liftmoore.com)

<b>PERIODIC MAINTENANCE SCHEDULE</b>		
MODEL 60100 CRANES		
BOLTS		
MOUNTING BOLTS	1.25-7 GRADE 8 TORQUE 1,875 FT-LBS DRY	EVERY 4 MONTHS
BEARING BOLTS	5/8-11 GRADE 8 TORQUE 220 FT-LBS DRY	EVERY 4 MONTHS
LUBRICATION		
GREASE FITTINGS	SEE DRAWING 50048	EVERY OTHER WEEK
HYDRAULIC FLUID	STANDARD Chevron AW Hydraulic Oil 46 or equivalent SAE 15 weight oil  COLD WEATHER AW 32 or equivalent SAE 10 weight oil	CHECK DAILY, FILL AS NEEDED
WINCH GEARBOX	SAE 90 lubricant oil or Swepeco #201 Multi-Purpose Gear Lube	EVERY MONTH
ROTATION GEARBOX	EP 01 Grease	EVERY MONTH
BEARING (ZERK AND TEETH)	Oil Center Research PM 600 Military grease or equivalent Benton Based Grease NLGI Grade 2	EVERY 6 HOURS OF OPERATION
BOOM	Coat with "Slip Plate" made by Superior Graphite or similar solid lubricant coating	AS NEEDED



F1757-0  
9/15/10

HOUSTON, TEXAS  
FAX: (800) 824-5559 (USA & Canada)  
FAX: (713) 688-6324  
PHONE: (713) 688-5533  
[www.liftmoore.com](http://www.liftmoore.com)

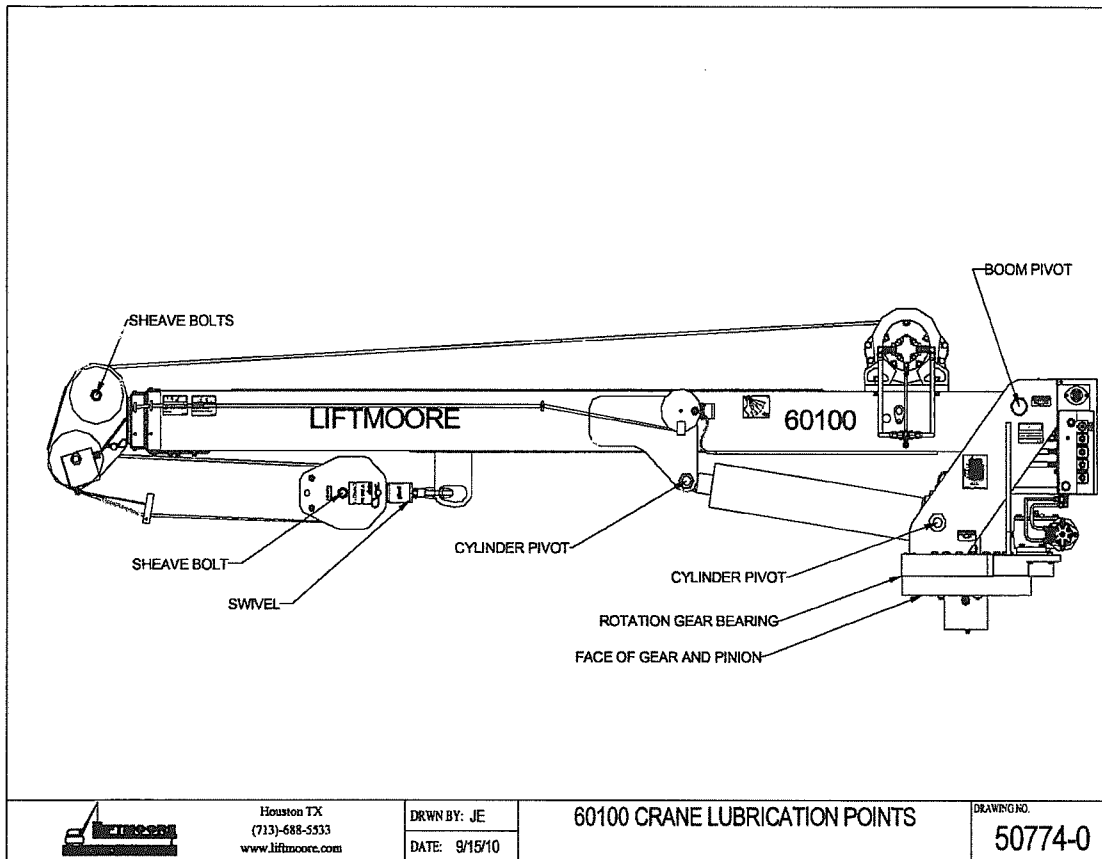

CRANE LUBRICATION POINTS



F1757-0  
9/15/10

HOUSTON, TEXAS  
 FAX: (800) 824-5559 (USA & Canada)  
 FAX: (713) 688-6324  
 PHONE: (713) 688-5533  
 www.liftmoore.com

THIS PAGE INTENTIONALLY LEFT BLANK



F1757-0  
9/15/10

HOUSTON, TEXAS  
FAX: (800) 824-5559 (USA & Canada)  
FAX: (713) 688-6324  
PHONE: (713) 688-5533  
[www.liftmoore.com](http://www.liftmoore.com)



**LIST FOR BOX, CRANE PARTS 60100**

P/N 25764 - BOX, CRANE PARTS 60100XP-24  
 BAIL ATB, RTZ TH2; KTG CONTROLS  
 P/N 22524 TRAVEL BLOCK

- 1) P/N 25749 - MANUAL, CRANE 60100XP-24..... 1pc
- 2) P/N 19487 - CW, 10 GA X 300" ..... 1pc
- 3) P/N 18457 - FUSE HOLDER, ATO 12GA SEALED ..... 1pc
- 4) P/N 21154 - FUSE, 30 AMP BLADE..... 1pc
- 5) P/N 32613 - ADAPTER, 8MJ-10MJ..... 1pc
- 6) P/N 17012 - SWITCH, TOGGLE SPST MAINT. /S ..... 1pc
- 7) P/N 17011 - BRACKET, SWITCH MNT. HYD. CRN. .... 1pc
- 8) P/N 16781 - TERMINAL, RING 10-12 GA #8..... 2pcs
- 9) P/N 17013 - PLATE, ON-OFF FOR TOGGLE SWCH..... 1pc
- 10) P/N 18600 - PLATE, CRANE-TRUCK STABILITY..... 1pc
- 11) P/N 22868 - INSTALLATION INTS. 72100..... 1pc
- 12) P/N 25047 - DECAL, LOAD CAPACITY 60K-11-24..... 1pc
- 13) P/N 23144 - LEVEL AND TAPE ASSEMBLY..... 1pc



F2078-0  
 05/15/13

HOUSTON, TEXAS  
 FAX: (800) 824-5559 (USA & Canada)  
 FAX: (713) 688-6324  
 PHONE: (713) 688-5533  
 www.liftmoore.com

**NOTE: INSTALL P/N 25704 WHITE/RED REFLECTIVE TAPE ON TOP CORNER ON BOTH SIDES OF EACH BOOM BELOW**  
**2ND INNER INSTALL 1" BACK FROM EDGE OF BOOM QTY-80"**  
**1ST INNER INSTALL 1" BACK FROM END OF PLATE QTY-80"**

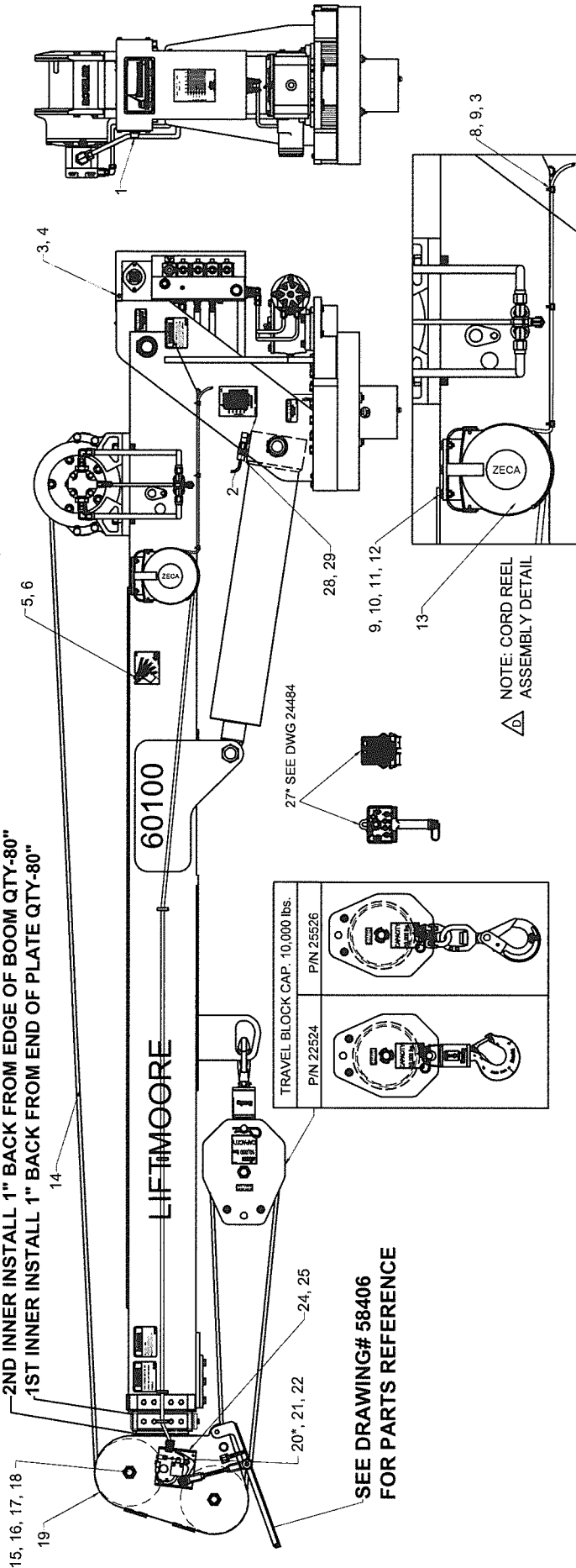

SEE DRAWING# 58406 FOR PARTS REFERENCE

ITEMS WITH \* HAVE DETAIL DRAWINGS

#	PN	DESCRIPTION	QTY	#	PN	DESCRIPTION	QTY	#	PN	DESCRIPTION	QTY
1	25362	EWB, DTCH HYD XP KTG W/HORN	1	14	24062	ROPE, WIRE 0.43 X 135' W/THIMBLE	1	27	24484	CONTROL, FM ASSY GUIDER XP	1
2	24061	PLATE, SERIAL 60100	1	15	32517	SCREW, SHEAVE SINGLE 1-8 4.00	2	28	20415	SWITCH, PRES. ASSY 2050PSI DTCH	1
3	30889	WASHER LOCK 0.25 GR5 PLATED	8	16	30838	NUT, HEX NYLOC 1.00-8 GR 5	2	29	32533	ADAPTER, 90° 4MP-4FP	1
4	30809	SCREW, HHC 0.25-20 X 0.50 GR 5	10	17	30936	ZERK, 0.25-28 STRAIGHT	2	NOT SHOWN			
5	22394	PENDULUM, LOAD RADIUS D/A. HD	2	18	31224	COVER, ZERK 1/4	2	19847	CONNECTOR, DTCH 2P PLUG	1	
6	31017	SCREW, SHOULDER 0.31-18 X 0.75	2	19	24063	SHEAVE ASSY 8.09PD X 0.43 ROPE	2	19845	CONNECTOR, DTCH 2P RECPT	1	
7	26582	SCREW, SOC HD 0.25-20 X 0.37 SS	3	20	25149	ATB ASSY, DEUTSCH CONN 72100	1	19846	WEDGE, DEUTSCH 2P PLUG	1	
8	24960	CLAMP, HOSE SUPPORT 0.25	3	21	32967	CLAMP, HOSE SUPPORT 0.62 ID	1	19848	WEDGE, DEUTSCH 2P RECPT	1	
9	70052	BRACKET, CORD REEL	1	22	30457	SCREW, HHC 0.25-20 X 0.75 GR5	2	24065	DECAL KIT 60100XP-24	1	
10	31110	WASHER, FLAT 0.25 GR5 PLATED	3	24	32658	PIN, CLEVIS 0.87 X 3.50	1				
11	30810	SCREW, HHC 0.25-20 X 1.00 GR5	3	25	31948	CLIP, HAIRPIN 0.87 - 1.00	1				
12	30833	NUT, HEX NYLOC 0.25-20 GR2	3								
13	25705	REEL, CORD ZECA 34 FT ASSY	1								

**LIFMOORE**  
Houston TX  
(713)-688-5533  
www.liftmoore.com

DRWN BY: JE  
DATE: 5/9/13

**CRANE ASSY 60100XP-24**  
BAIL ATB, ZECA REEL; NEW PADS

DRAWING NO.  
**25748-D**

TRANSMITTER AND RECEIVERS ARE PROGRAMMED TO FORM A MATCHED SET SO THAT A TRANSMITTER ONLY OPERATES ONE CRANE. IF EITHER PART IS REPLACED, THE RECEIVER MUST BE PROGRAMMED TO THE TRANSMITTER USING A TEMPORARY WIRING HARNESS AVAILABLE FROM LIFTMOORE.

P/N 24453 CONTROL, FM TRANS HYD XP DRA K

NOT SHOWN:

P/N 20185 WIRE, CTRL FM TEATHER 5P PLUG  
P/N 20186 CAR CHARGER, FM TRANS

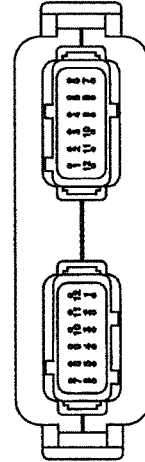
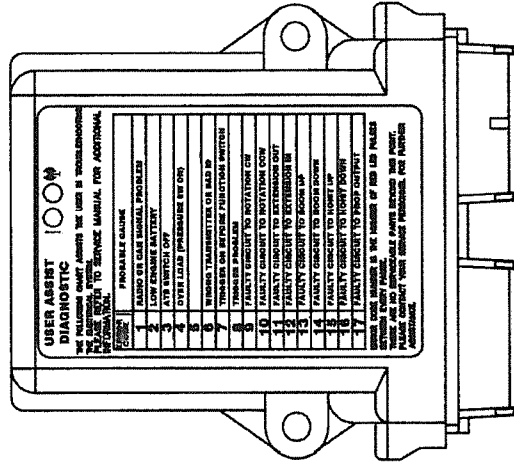
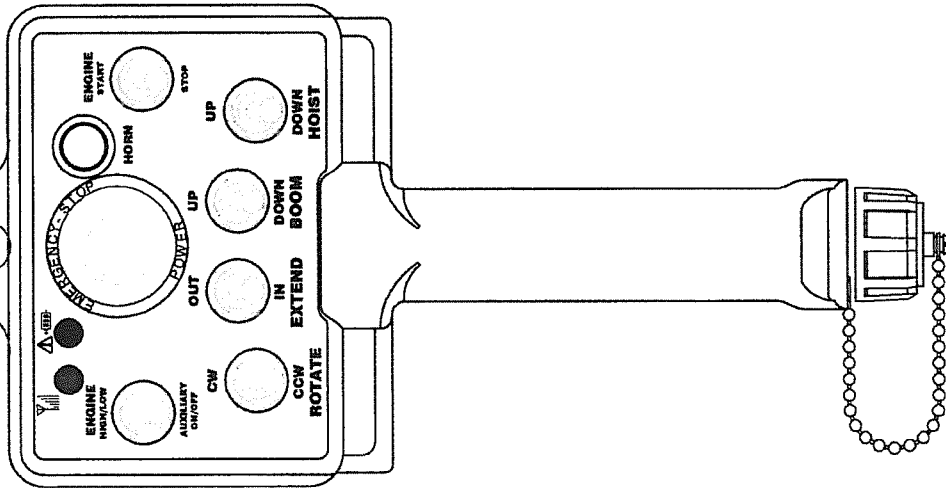

OPTIONAL:

P/N 24510 INTERNATIONAL WALL CHARGER 110V

P1:12 PIN DEUTSCH DTM13-12PA

PIN#	DESCRIPTION	COLOR
1	GROUND	BRN
2	CAN HIGH	WHT
3	CAN LOW	GRN
4	PROGRAMMING PIN	
5	ATB SWITCH IN (DI2)	YEL/BLK
6	PRESSURE SWITCH IN (ANO)	BLU/BLK
7	NO CONNECTION	
8	PRESSURE TRANSDUCER IN (AN2)	
9	NO CONNECTION	
10	NO CONNECTION	
11	HORN OUT PUT	
12	POWER (9 TO 35 VDC)	RED

P2:12 PIN DEUTSCH DTM13-12PB

PIN#	DESCRIPTION	COLOR
1	ROTATION CW OUTPUT	RED
2	ROTATION CCW OUTPUT	RED/BLK
3	EXTENSION OUT OUTPUT	ORN/BLK
4	EXTENSION IN OUTPUT	GRN/BLK
5	BOOM UP OUTPUT	GRN
6	BOOM DOWN OUTPUT	ORN
7	HOIST UP OUTPUT	BLU
8	HOIST DOWN OUTPUT	BLK
9	PROPORTIONAL	WHT/BLK
10	RS232 GND (PALM PILOT)	
11	RE232 RX (PALM PILOT)	
12	RS232 TX (PALM PILOT)	

Houston TX  
(713)-688-5533  
www.liftmoore.com

DRWN BY: JE  
DATE: 4/21/11

BOX, FM RECEIVER XP KT GUIDER  
WITH HORN OUTPUT

DRAWING NO.  
**24484-A**



P/N 24455 CONTROL, FM RECEIVER ENG/AUX GUIDER

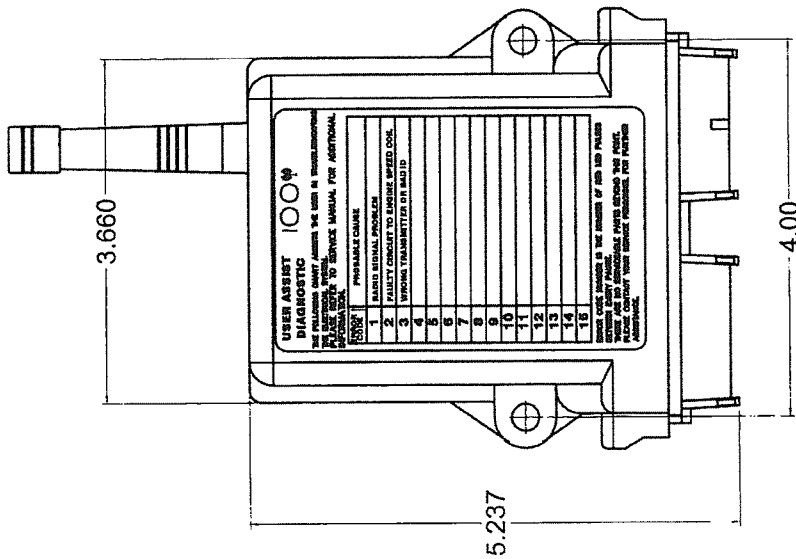

P/N 21336 EWH, ENGINE CTRL RCVR KTFM DRA

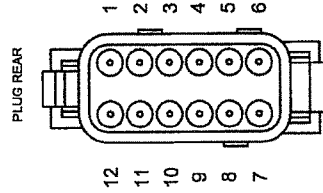
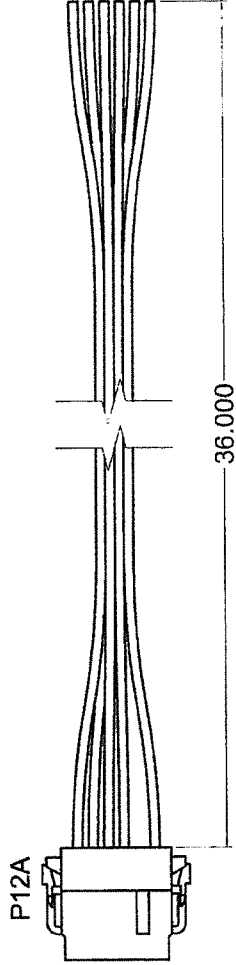

P12A - ENGINE RECEIVER		
PIN	COLOR	DESC
1	BLK	GRND
8	YEL/BLK	AUX
9	BRN	ENG START
10	GRY	ENG STOP
11	BLU/BLK	ENG HI IDLE
12	RED	PWR
SEAL PIN IN ALL OTHER CONTACTS		
SUPPLY VOLTAGE TO PIN 5 TO CHANGE ENG HI IDLE OUTPUT TO MOMENTARY		

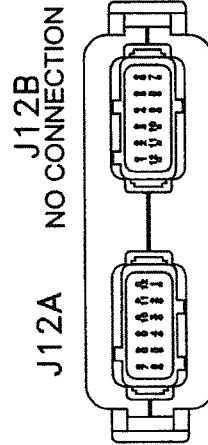

SEE FORM 1214 FOR GENERAL INFORMATION ON INTERFACING WITH ECM AND CONTACT INFORMATION FOR VEHICLE AND ENGINE MANUFACTURERS

Houston TX  
(713)-688-5533  
www.lifmoore.com

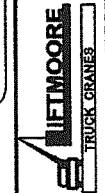

FM ENGINE CONTROL REPRESENTATION  
WITH AUXILIARY FUNCTION, 3RD GEN KTFM GUIDER

DRAWING NO.

24455-0

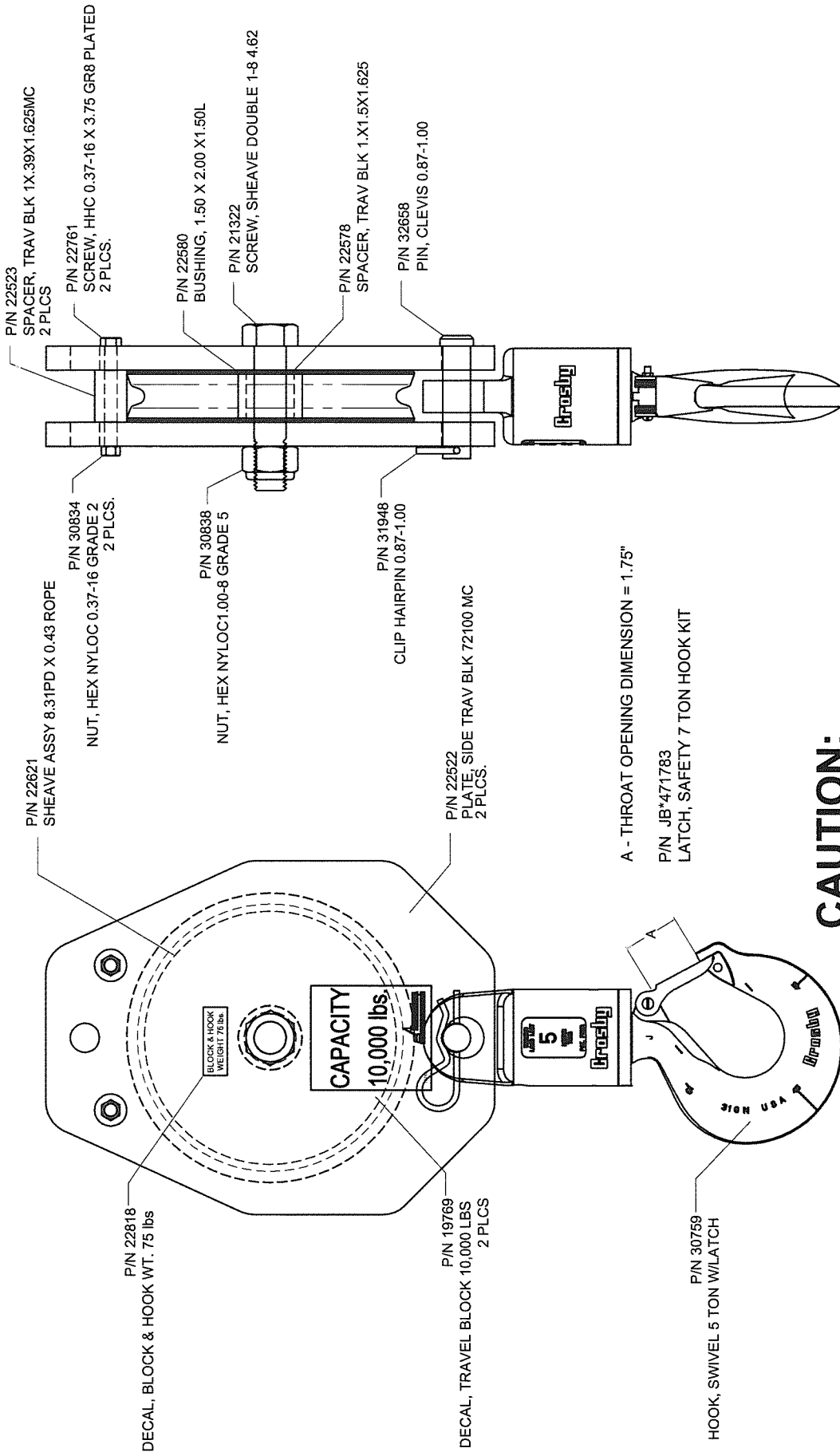

**CAUTION:**

NEVER USE A HOOK WHOSE THROAT OPENING HAS BEEN INCREASED, OR WHOSE TIP HAS BEEN BENT MORE THAN 10 DEGREES OUT OF PLANE FROM THE HOOK BODY, OR IS IN ANY WAY DISTORTED OR BENT.

DRAWING NO. <b>22524-C</b>	BLOCK, TRAV ASSY 10K lbs/9.0D 8.31PD X 0.43 ROPE: 10,000LBS	DRWN BY: JC DATE: 6/23/08	Houston TX (713)-688-5533 www.lifmoore.com 
-------------------------------	--	------------------------------	---

CROWN PLATE FOR REFERENCE ONLY

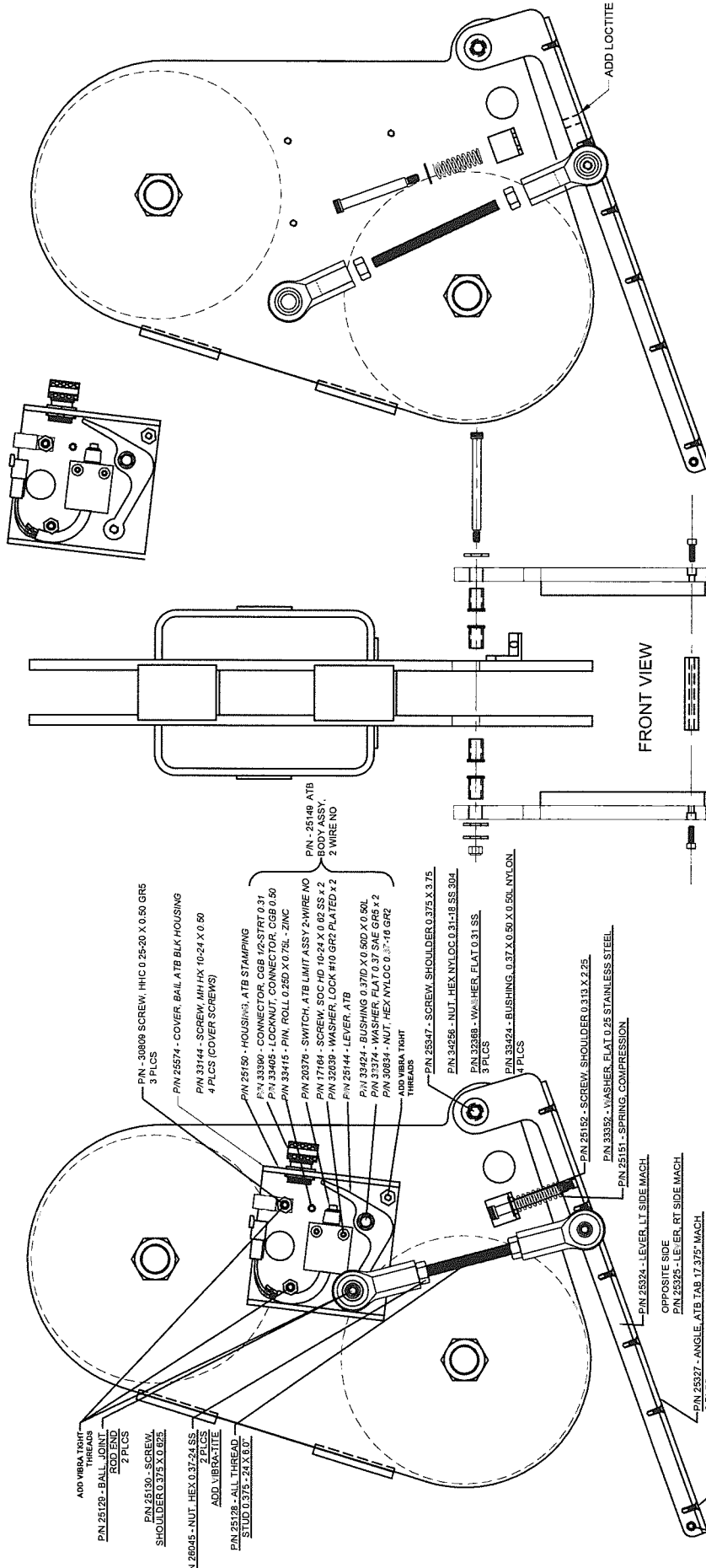

**NOTE**

P/N 25537 - KIT, BAIL ATB REPLACEMENT 72100  
 INCLUDED ALL UNDERLINED ITEMS FOR BAIL ATB

<p>DRAWING NO. <b>58406-G</b></p>	<p><b>ATB BAIL ASSY, DEUTSCH CONN</b>          TWO-WIRE NORMALLY OPEN 60100/72100 BAIL ATB LIFT SIDE</p>	<p>DRWN BY: JE          DATE: 12/7/12</p>	<p>Houston TX          (713)-688-5533          www.liftmoore.com</p> <p><b>LIFTMOORE</b>          TRUCK CRANES</p>
---------------------------------------	--	---	--

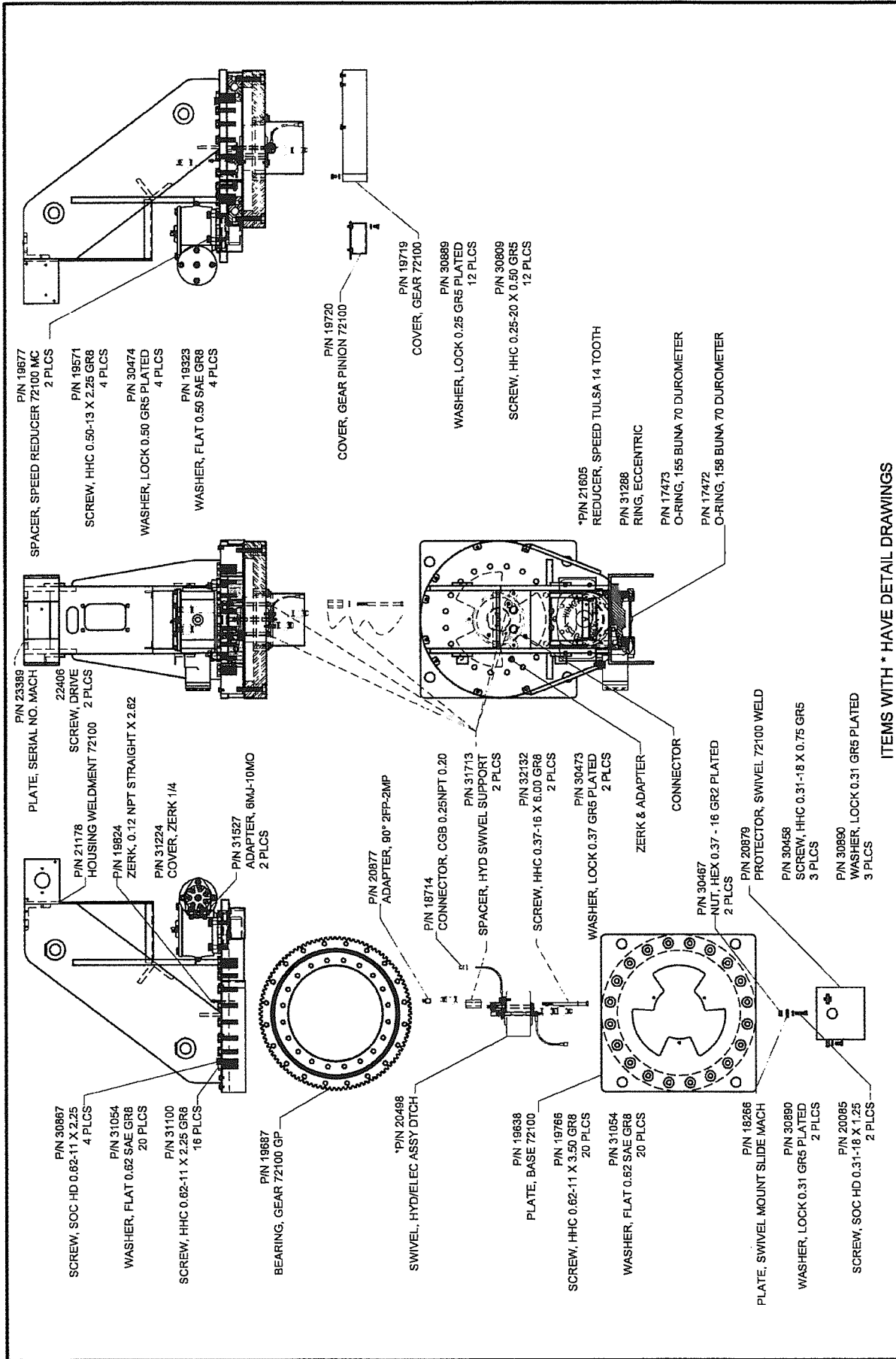

- P/N 19677 SPACER, SPEED REDUCER 72100 MC 2 PLCS
- P/N 19571 SCREW, HHC 0.50-13 X 2.25 GR8 4 PLCS
- P/N 30474 WASHER, LOCK 0.50 GR5 PLATED 4 PLCS
- P/N 19323 WASHER, FLAT 0.50 SAE GR8 4 PLCS
- P/N 19720 COVER, GEAR PINION 72100
- P/N 19719 COVER, GEAR 72100
- P/N 30889 WASHER, LOCK 0.25 GR5 PLATED 12 PLCS
- P/N 30809 SCREW, HHC 0.25-20 X 0.50 GR5 12 PLCS
- \*P/N 21605 REDUCER, SPEED TULSA 14 TOOTH
- P/N 31288 RING, ECCENTRIC
- P/N 17473 O-RING, 155 BUNA 70 DUROMETER
- P/N 17472 O-RING, 158 BUNA 70 DUROMETER
- P/N 23389 MOTOR, SERIAL NO. MACH
- 22406 SCREW, DRIVE
- P/N 21178 HOUSING WELDMENT 72100 2 PLCS
- P/N 19824 ZERK, 0.12 NPT STRAIGHT X 2.62
- P/N 31224 COVER, ZERK 1/4
- P/N 31527 ADAPTER, 6MJ-10MO 2 PLCS
- P/N 20877 ADAPTER, 90° 2FP-2MP
- P/N 18714 CONNECTOR, CGB 0.25NPT 0.20
- P/N 31713 SPACER, HYD SWIVEL SUPPORT 2 PLCS
- P/N 32132 SCREW, HHC 0.37-16 X 6.00 GR8 2 PLCS
- P/N 30473 WASHER, LOCK 0.37 GR5 PLATED 2 PLCS
- ZERK & ADAPTER
- CONNECTOR
- P/N 30467 NUT, HEX 0.37 - 16 GR2 PLATED 2 PLCS
- P/N 20879 PROTECTOR, SWIVEL 72100 WELD
- P/N 30458 SCREW, HHC 0.31-18 X 0.75 GR5 3 PLCS
- P/N 30890 WASHER, LOCK 0.31 GR5 PLATED 3 PLCS
- P/N 30867 SCREW, SOC HD 0.62-11 X 2.25 4 PLCS
- P/N 31054 WASHER, FLAT 0.62 SAE GR8 20 PLCS
- P/N 31100 SCREW, HHC 0.62-11 X 2.25 GR8 16 PLCS
- P/N 19687 BEARING, GEAR 72100 GP
- \*P/N 20498 SWIVEL, HYD/ELEC ASSY DTCH
- P/N 19638 PLATE, BASE 72100
- P/N 19766 SCREW, HHC 0.62-11 X 3.50 GR8 20 PLCS
- P/N 31054 WASHER, FLAT 0.62 SAE GR8 20 PLCS
- P/N 18286 PLATE, SWIVEL MOUNT SLIDE MACH
- P/N 30890 WASHER, LOCK 0.31 GR5 PLATED 2 PLCS
- P/N 20085 SCREW, SOC HD 0.31-18 X 1.25 2 PLCS

ITEMS WITH \* HAVE DETAIL DRAWINGS

	Houston TX (713)-688-5533 www.liftnoore.com	DRAWN BY: KSP DATE: 10/25/10	DRAWING NO. <b>21801-E</b>
	<b>BASE-HOUSING ASSY 72100XP TULSA</b> TULSA SPEED REDUCER		

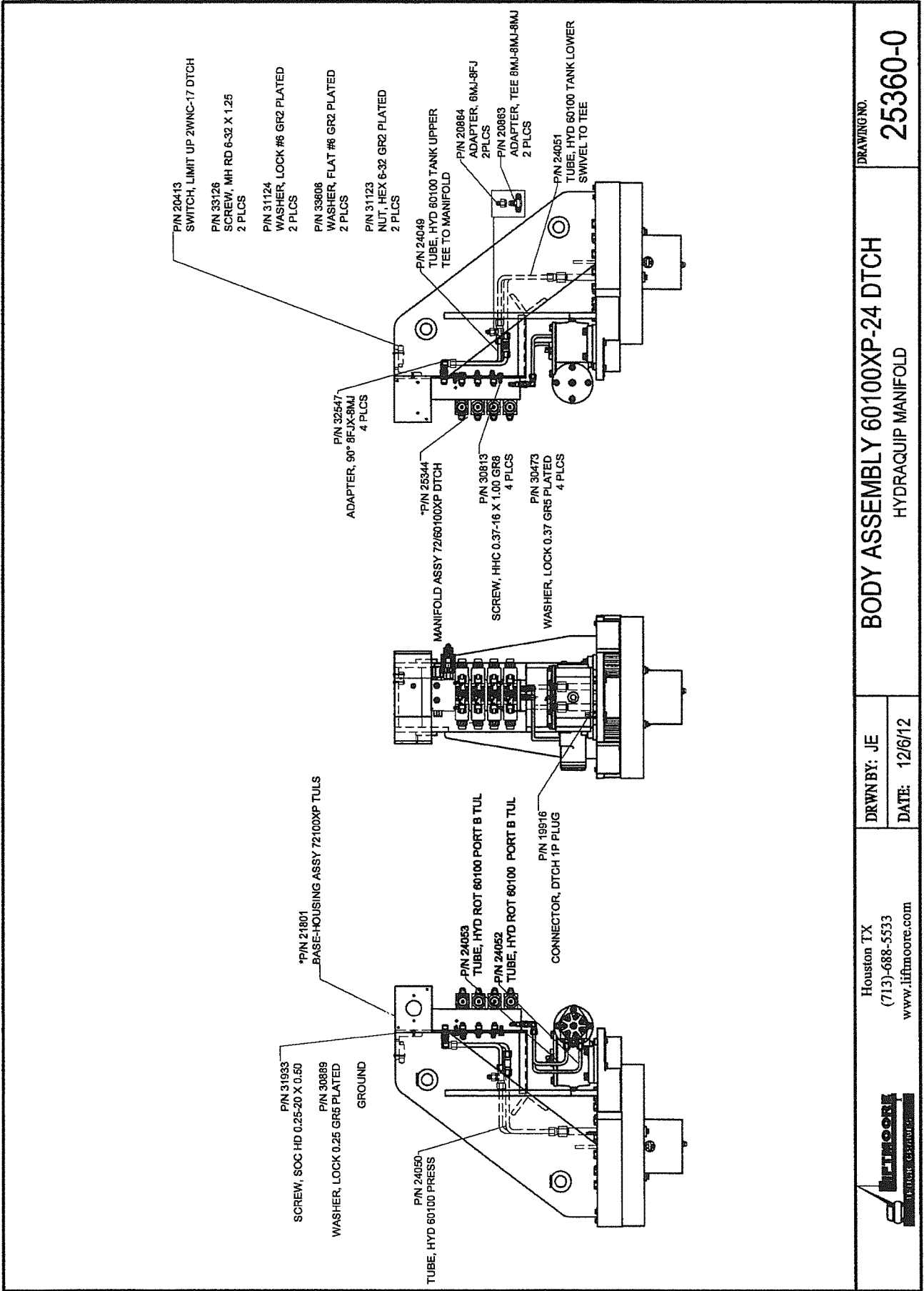

DRAWING NO.

25360-0

**BODY ASSEMBLY 60100XP-24 DTCH**  
HYDRAQUIP MANIFOLD

DRWN BY: JE

DATE: 12/6/12

Houston TX  
(713)-688-5533  
www.lifmoores.com





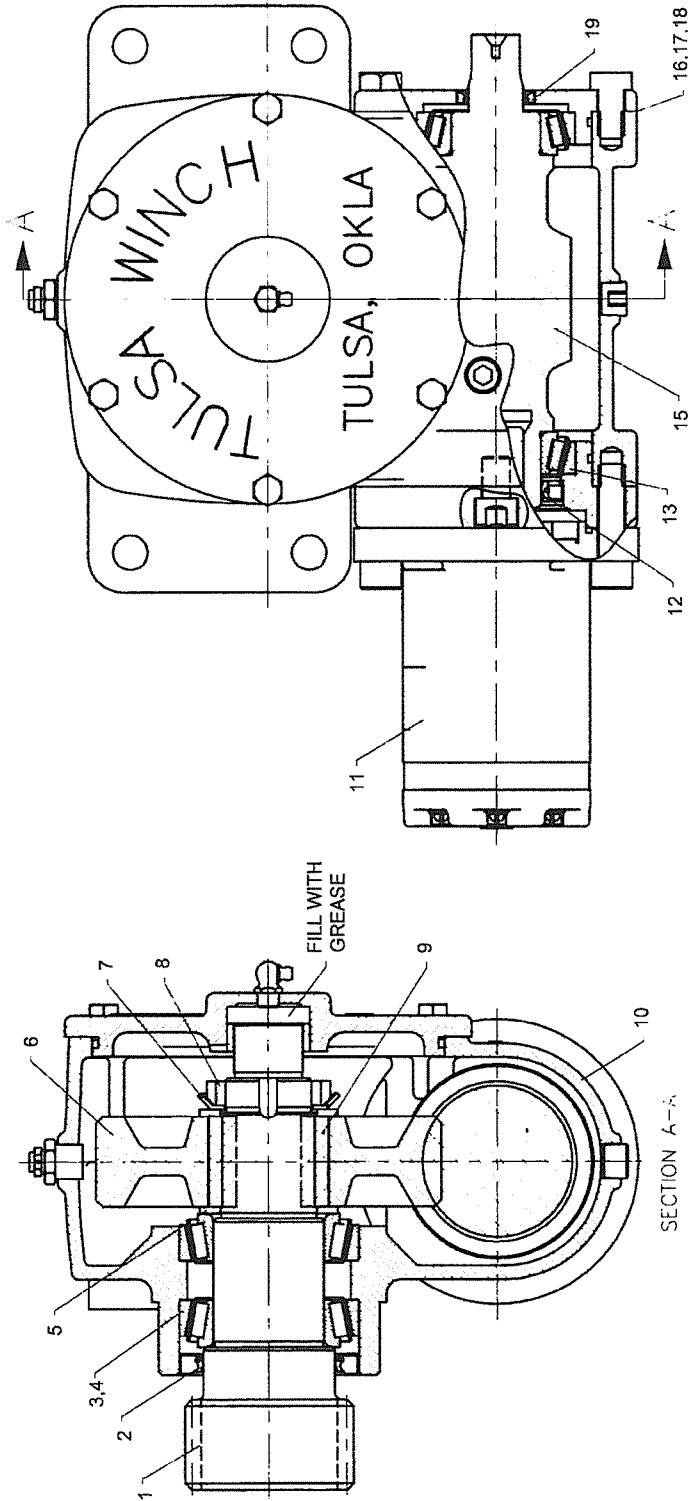

1. APPLY LOC-TITE TO THREADS OF SHAFT (ITEM 1) THEN TORQUE BEARING LOCKNUT (ITEM 8) TO 50 FT.-LBS. LOOSEN AND RETORQUE TO 20-30 FT.-LBS.
2. PAINT ALL EXTERIOR SURFACES EXCEPT GEAR, GEAR SHAFT, ECCENTRIC RING, AND HOUSING PILOT WITH TWI PRIME SPEC 709169 (WHITE PAINT).
3. SHIM AS NECESSARY TO ACHIEVE -.002 TO .000 WORM MOVEMENT AXIALLY. (USE SHIMS 42366, 42367, & 42368 TO ACHIEVE PROPER MOVEMENT).
4. FILL WITH E.P. 0 GREASE.

ITEMS WITH \* HAVE DETAIL DRAWINGS

#	PN	DESCRIPTION	QTY	#	PN	DESCRIPTION	QTY	#	PN	DESCRIPTION	QTY
1	TW*43469	SHAFT, OUTPUT, HFG938D	1	8	TW*26528	LOCKNUT	1	15	TW*43745	WORM, SR, HFG945D	1
2	TW*41979	SEAL, OIL, HFG938D	1	9	TW*40518	KEY	2	16	TW*42366	SHIM, G1600D	2
3	TW*41983	CUP, BEARING, HFG93	2	10	TW*43492	HOUSING, HFG938D	1	17	TW*42367	SHIM, G1600D	2
4	TW*41982	CONE, BEARING, HFG9	2	11	19978	MOTOR, HYD 4.50 CID CHAR-LYNN	1	18	TW*42368	SHIM, G1600D	2
5	TW*40510	WASHER, THRUST	2	12	TW*33155	SEAL, OIL	1	19	TW*24180	SEAL, OIL	1
6	TW*42578	GEAR, SR, HFG945D	1	13	TW*996515	CONE, BEARING	2				
7	TW*41299	WASHER, LOCK	1	14	TW*996516	CUP, BEARING	2				

Houston TX  
(713)-688-5533  
www.iffmoore.com



REDUCER, SPEED TULSA 14 TOOTH  
15K IN-LBS, 14T PINON, BEARING

DRAWING NO.

21605-0

**NOTE**

ON THE BOTTOM OF THE SWIVEL, THE TANK PORT USES A #10 FITTING, AND THE PRESSURE PORT USES A #8 FITTING.

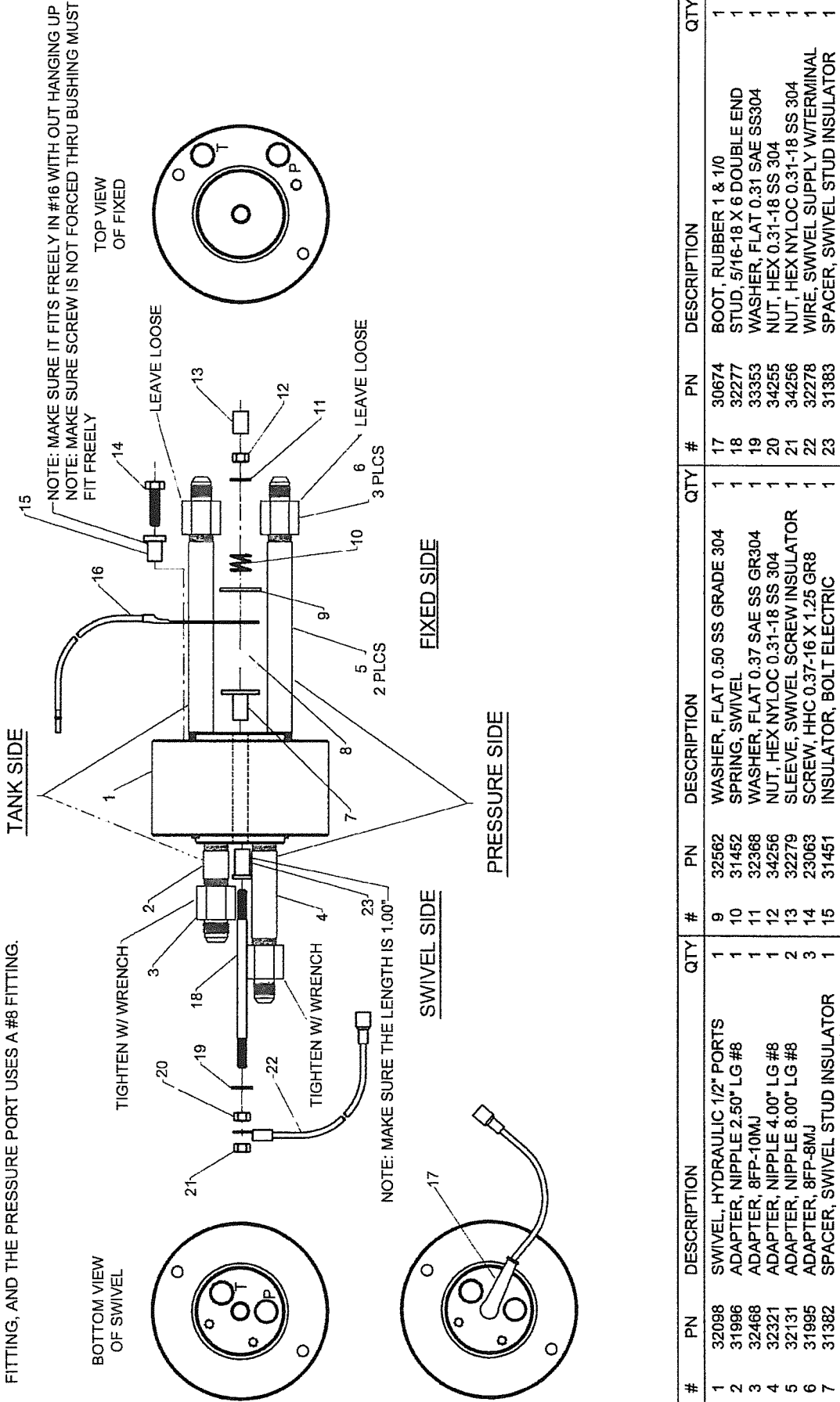

NOTE: MAKE SURE IT FITS FREELY IN #16 WITH OUT HANGING UP  
 NOTE: MAKE SURE SCREW IS NOT FORCED THRU BUSHING MUST FIT FREELY

TOP VIEW OF FIXED

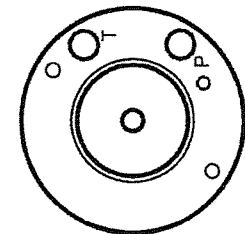

TANK SIDE

FIXED SIDE

PRESSURE SIDE

SWIVEL SIDE

BOTTOM VIEW OF SWIVEL

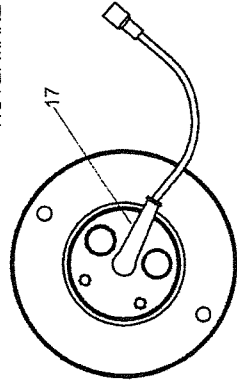
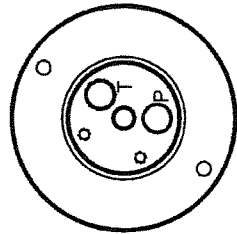

#	PN	DESCRIPTION	QTY	#	PN	DESCRIPTION	QTY	#	PN	DESCRIPTION	QTY
1	32088	SWIVEL, HYDRAULIC 1/2" PORTS	1	9	32562	WASHER, FLAT 0.50 SS GRADE 304	1	17	30674	BOOT, RUBBER 1 & 1/0	1
2	31986	ADAPTER, NIPPLE 2.50" LG #8	1	10	31452	SPRING, SWIVEL	1	18	32277	STUD, 5/16-18 X 6 DOUBLE END	1
3	32468	ADAPTER, 8FP-10MJ	1	11	32368	WASHER, FLAT 0.37 SAE SS GR304	1	19	33353	WASHER, FLAT 0.31 SAE SS304	1
4	32321	ADAPTER, NIPPLE 4.00" LG #8	1	12	34256	NUT, HEX NYLOC 0.31-18 SS 304	1	20	34255	NUT, HEX 0.31-18 SS 304	1
5	32131	ADAPTER, NIPPLE 8.00" LG #8	2	13	32279	SLEEVE, SWIVEL SCREW INSULATOR	1	21	34256	NUT, HEX NYLOC 0.31-18 SS 304	1
6	31985	ADAPTER, 8FP-8MJ	3	14	23063	SCREW, HHC 0.37-16 X 1.25 GR8	1	22	32278	WIRE, SWIVEL SUPPLY W/TERMINAL	1
7	31382	SPACER, SWIVEL STUD INSULATOR	1	15	31451	INSULATOR, BOLT ELECTRIC	1	23	31383	SPACER, SWIVEL STUD INSULATOR	1
8	31381	SPACER, SWIVEL UPPER - BRONZE	1	16	20500	WIRE, SWIVEL HOT PLATE ASSY D	1				

	Houston TX (713)-688-5533 www.liftmoore.com	SWIVEL, HYD/ELEC ASSY DTCH 1/2" PORTS, DEUTSCH CONNECTOR	DRAWING NO. <b>20498-E</b>
	DRWN BY: KSP DATE: 3/23/09		

BACK VIEW

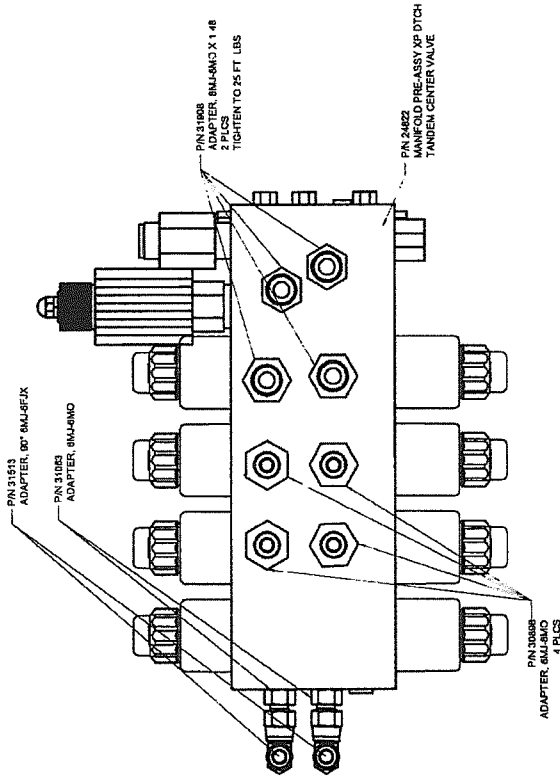

FRONT VIEW

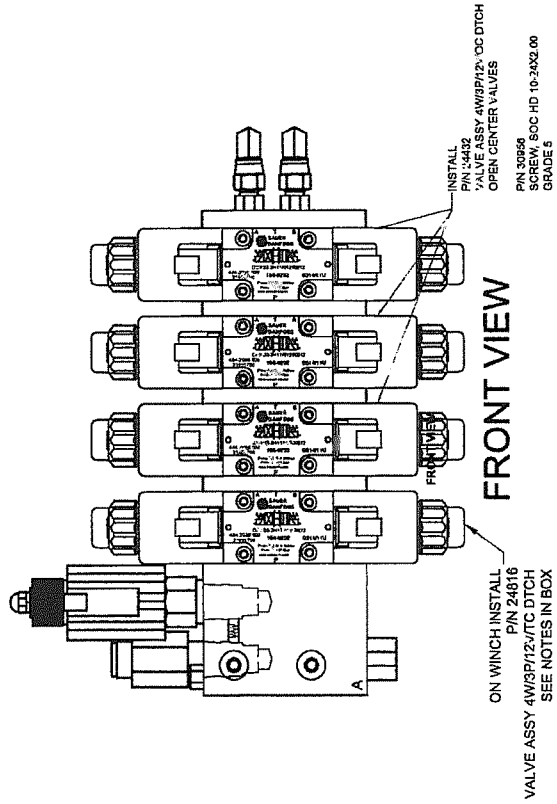

DRAWING NO.  
25344-0

MANIFOLD ASSY 72160100XP DTCH

DRWN BY: AA

DATE: 1/27/12

Houston TX  
(713)-688-5533  
www.liftmoore.com



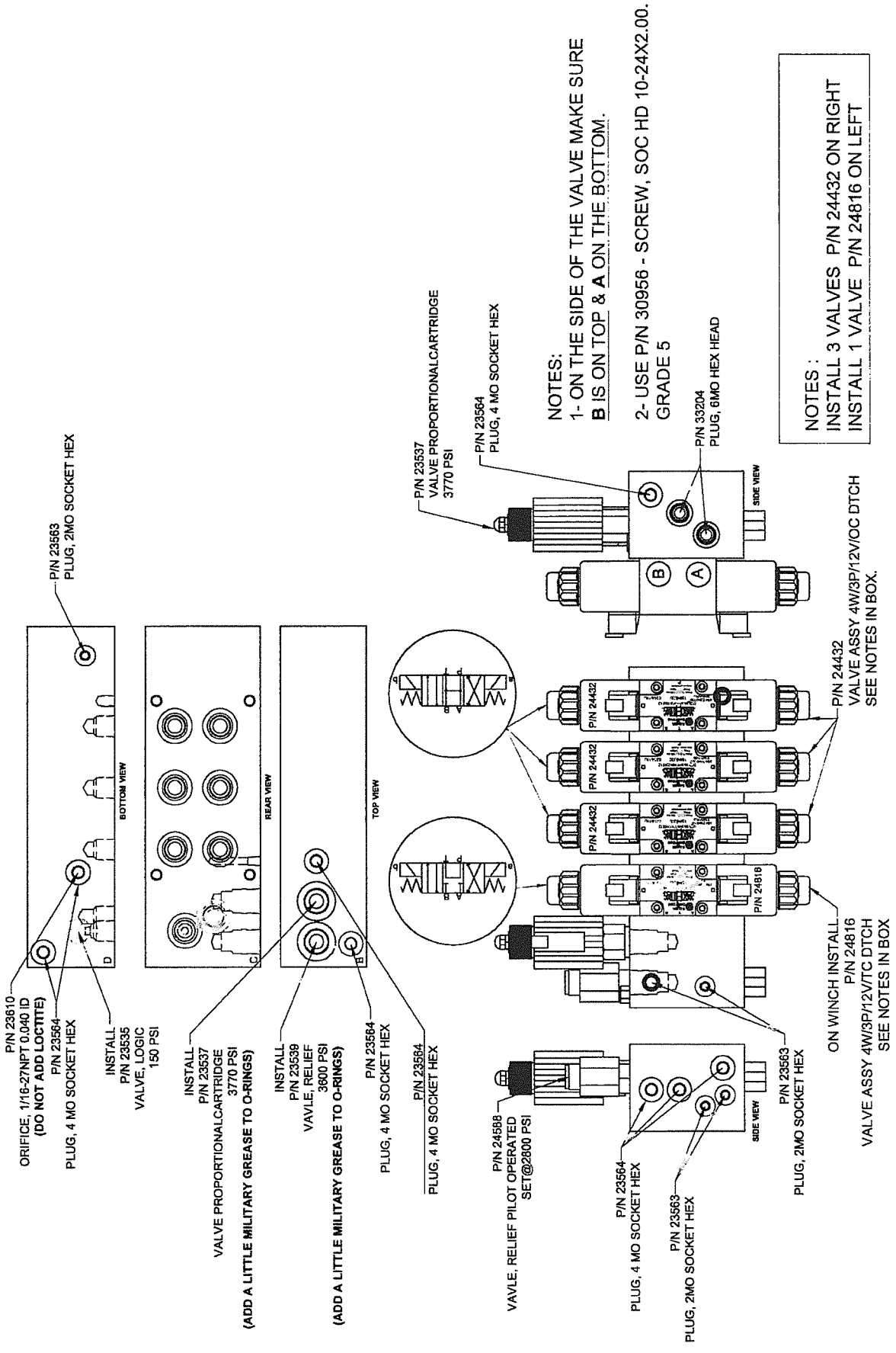

**NOTES:**  
 1- ON THE SIDE OF THE VALVE MAKE SURE **B** IS ON TOP & **A** ON THE BOTTOM.  
 2- USE P/N 30956 - SCREW, SOC HD 10-24X2.00.

**NOTES:**  
 INSTALL 3 VALVES P/N 24432 ON RIGHT  
 INSTALL 1 VALVE P/N 24816 ON LEFT

DRAWING NO. **24822-A**

**MANIFOLD PRE ASSY XP DTCH**  
 TANDEM CENTER VALVE

DRWN BY: JE  
 DATE: 12/21/11

ON WINCH INSTALL  
 P/N 24816  
 VALVE ASSY 4W/3P/12V/TC DTCH  
 SEE NOTES IN BOX

ON WINCH INSTALL  
 P/N 24432  
 VALVE ASSY 4W/3P/12V/IOC DTCH  
 SEE NOTES IN BOX

Houston, TX  
 (713)-688-5533  
 www.liftmoore.com



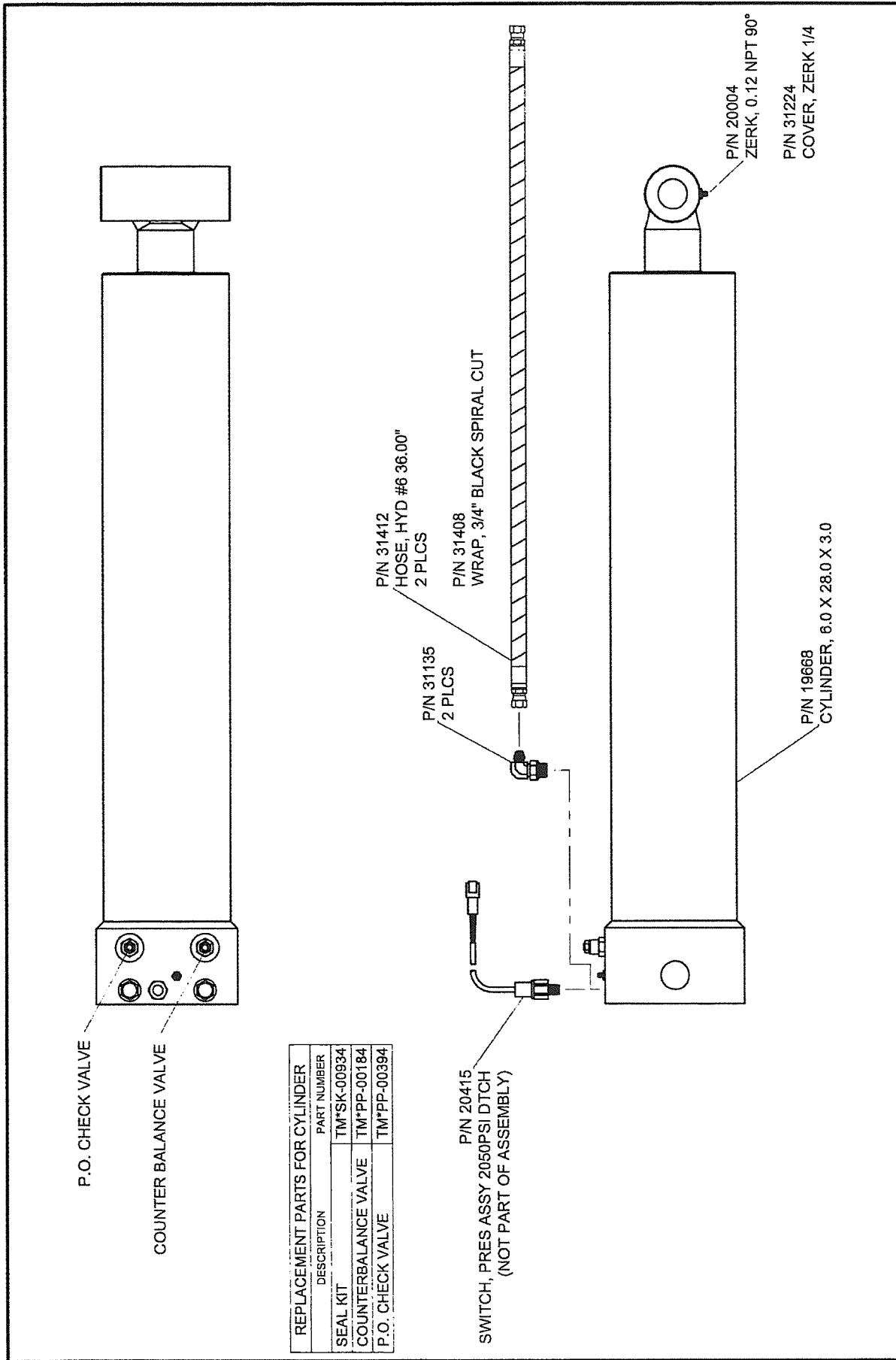

REPLACEMENT PARTS FOR CYLINDER	
DESCRIPTION	PART NUMBER
SEAL KIT	TM*SK-00934
COUNTERBALANCE VALVE	TM*PP-00184
P.O. CHECK VALVE	TM*PP-00394

	Houston TX (713)-688-5533 www.liftmoore.com	DRWN BY: JC DATE: 01/03/08	DRAWING NO. <b>19802-C</b>
	<b>CYLINDER ASSY 72100 ELEVLS</b>		

**NOTE: TORQUE ALL WEAR PAD SCREWS 0.37-16 TO 25 FT-LBS**

**NOTE: MAKE SURE ALL SEAMS ARE GRINDED BEFORE ASSEMBLY**

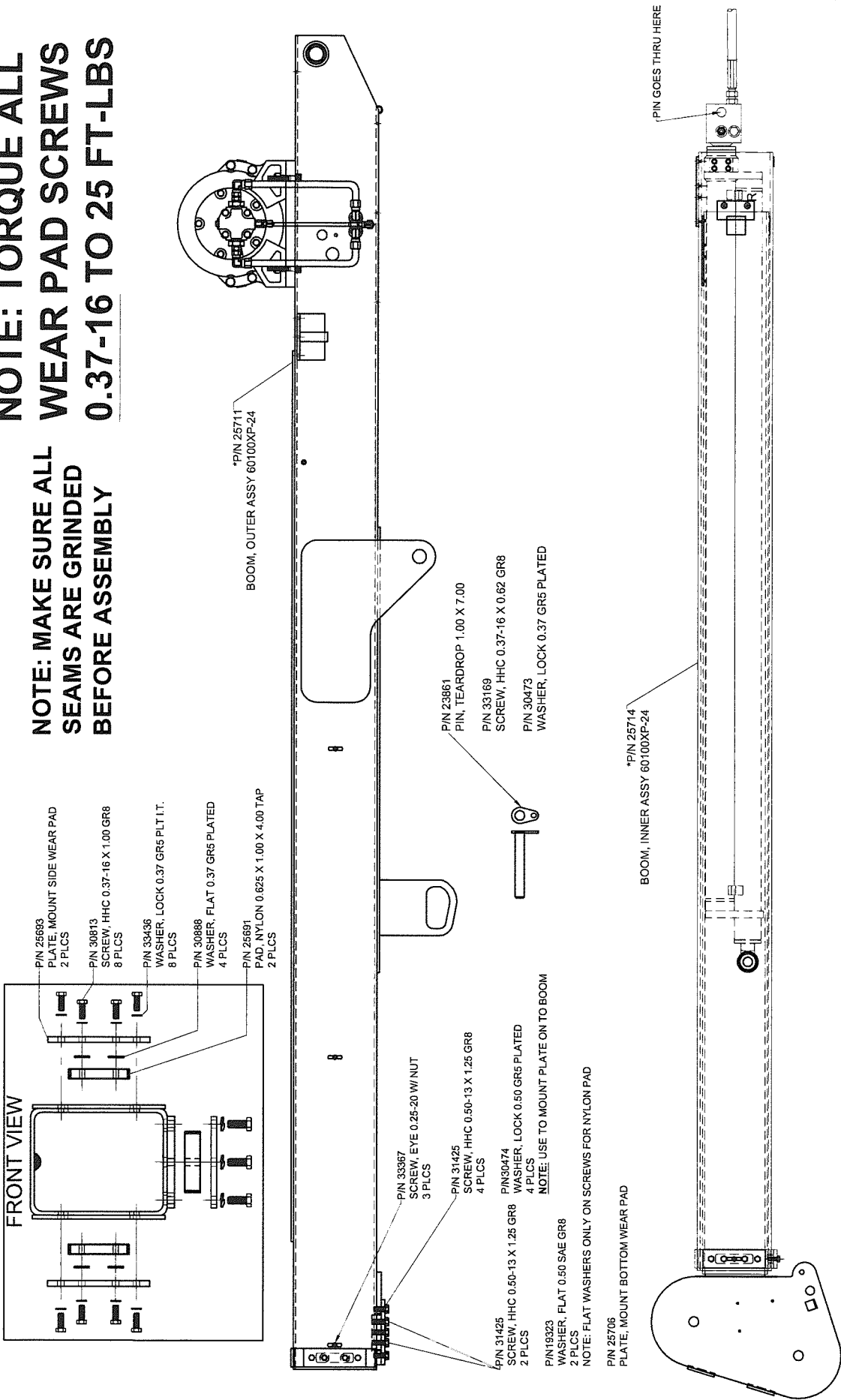

	Houston TX (713)-688-5533 www.liftmoore.com	DRWN BY: JE DATE: 5/8/13	BOOM ASSEMBLY 60100XP-24 BAIL ATB LEFT SIDE; NEW PADS, ZECA REEL	DRAWING NO. <b>25746-C</b>
--	---	-----------------------------	---	-------------------------------

**NOTE: TORQUE ALL WEAR PAD SCREWS 0.37-16 TO 25 FT-LBS**

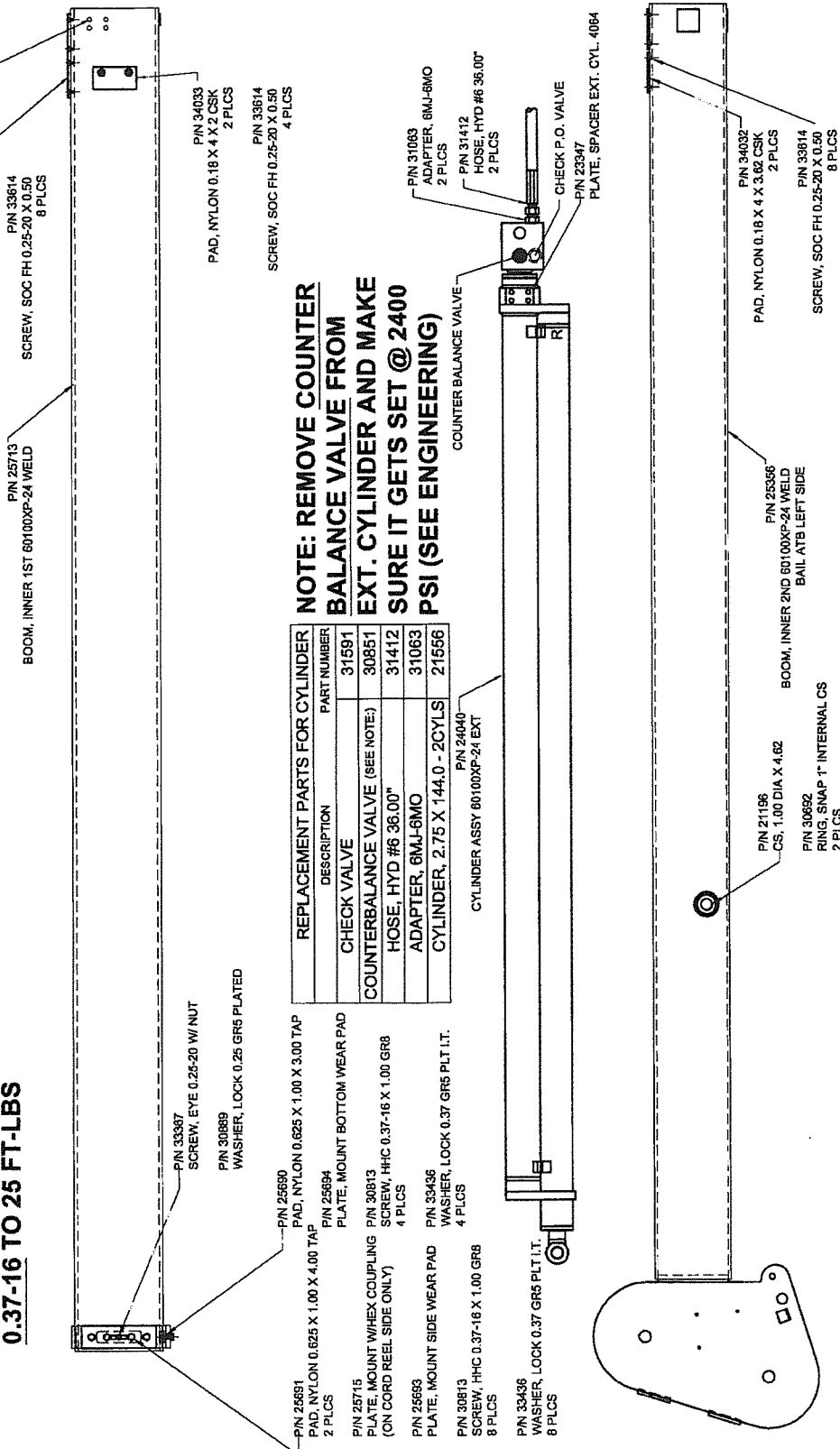

**NOTE: REMOVE COUNTER BALANCE VALVE FROM EXT. CYLINDER AND MAKE SURE IT GETS SET @ 2400 PSI (SEE ENGINEERING)**

REPLACEMENT PARTS FOR CYLINDER	
DESCRIPTION	PART NUMBER
CHECK VALVE	31591
COUNTERBALANCE VALVE (SEE NOTE)	30851
HOSE, HYD #6 36.00"	31412
ADAPTER, 6MJ-6MO	31063
CYLINDER, 2.75 X 144.0 - 2CYLS	21556

**HOUSTON LIFTMOORE**  
ELEVATOR SYSTEMS

Houston TX  
(713)-688-5533  
www.liftmoore.com

DRAWN BY: JE  
DATE: 5/8/13

DRAWING NO.  
**25714-0**

**BOOM, INNER ASSY 60100XP-24**  
BAIL ATB LEFT SIDE, ZECA CORD REEL

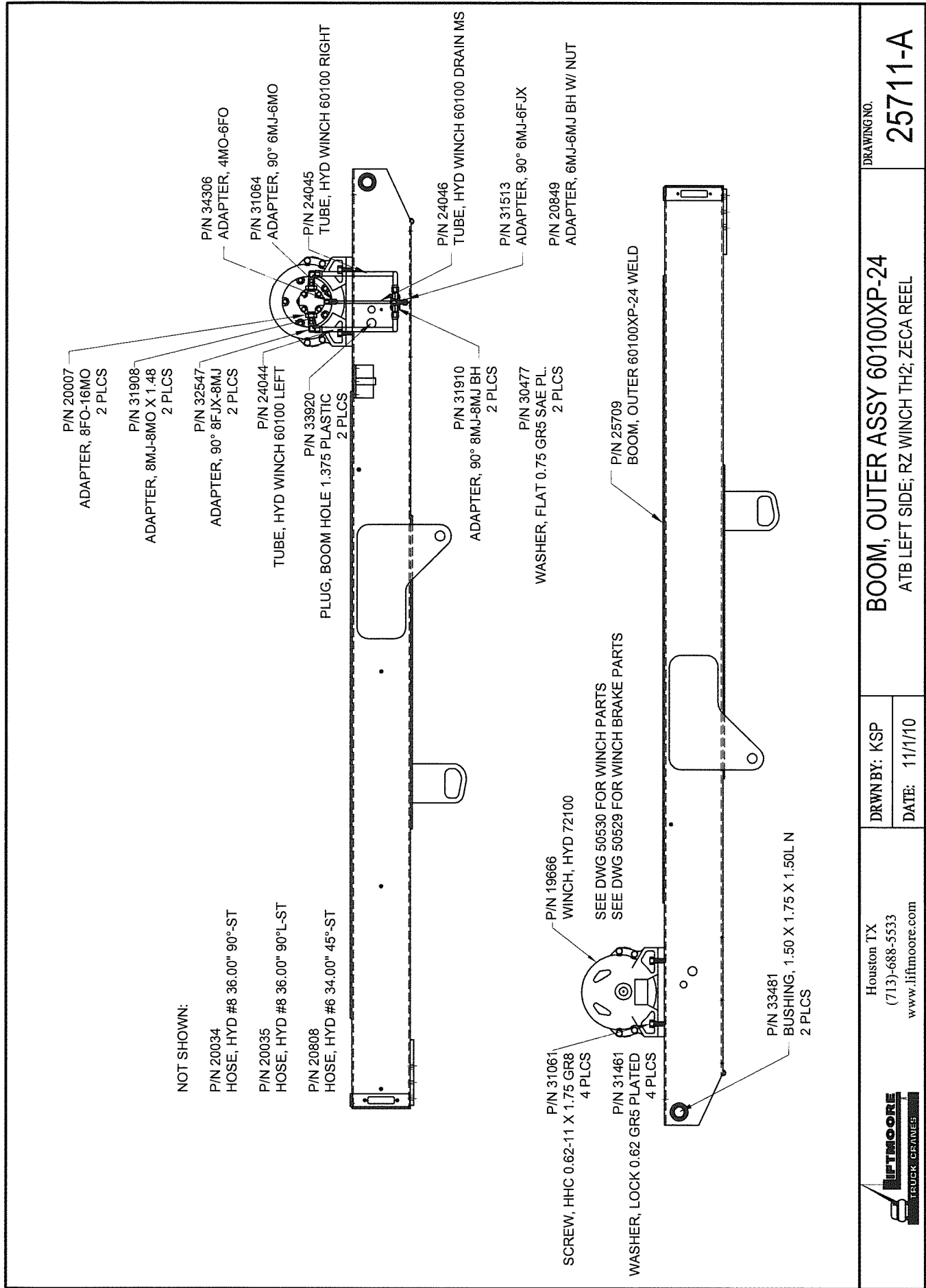

DRAWING NO.  
**25711-A**

**BOOM, OUTER ASSY 60100XP-24**  
 ATB LEFT SIDE; RZ WINCH TH2; ZECA REEL

DRWN BY: KSP  
 DATE: 11/1/10

Houston TX  
 (713)-688-5533  
 www.liftmoore.com





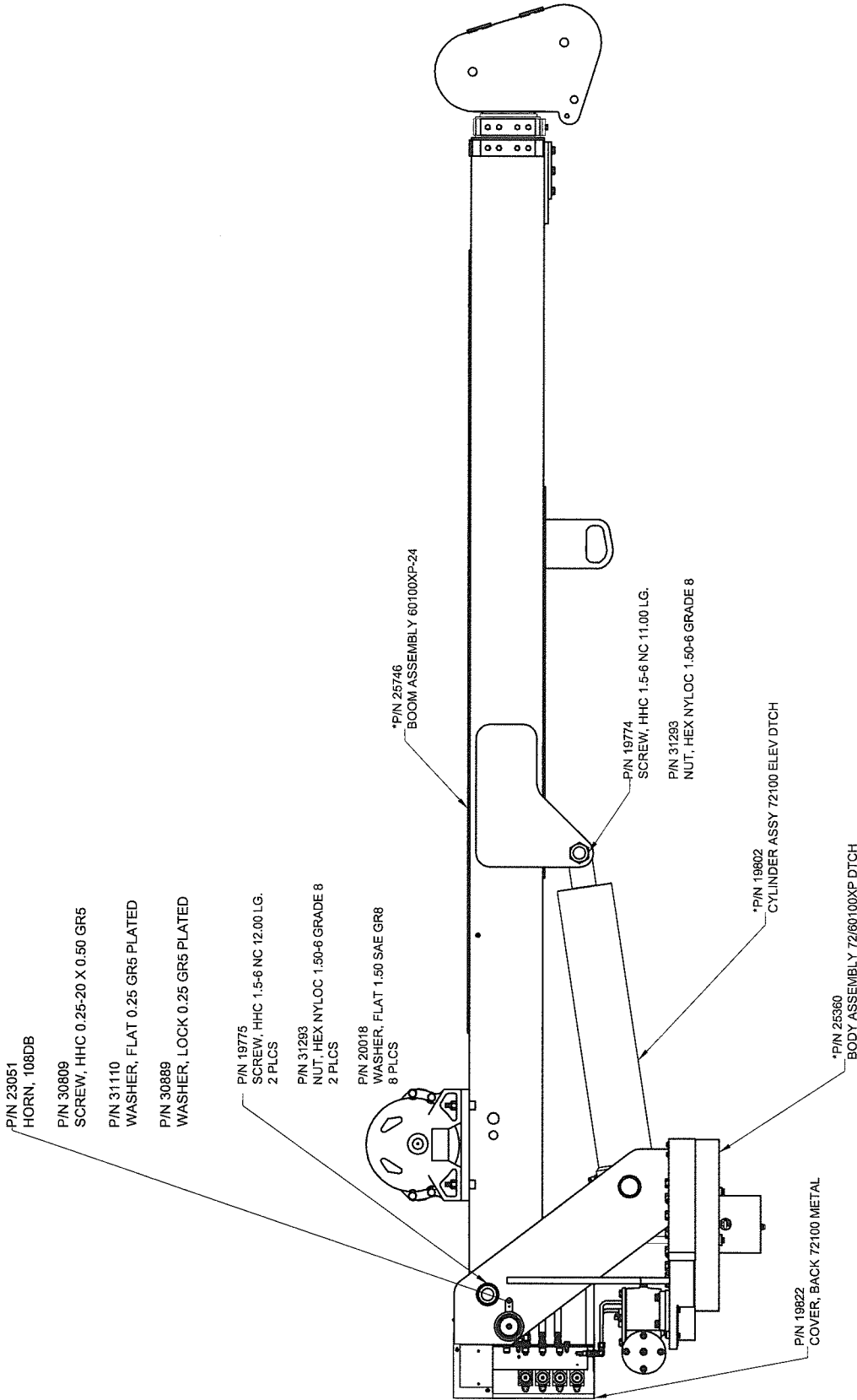

DRAWING NO.

25747-A

**BOOM-BODY 60100XP-24**

BAIL ATB, HORN, 108 DB, ZECA, NEW PADS

DRWN BY: JE

DATE: 12/6/12

Houston TX  
 (713)-688-5533  
 www.liftmoore.com



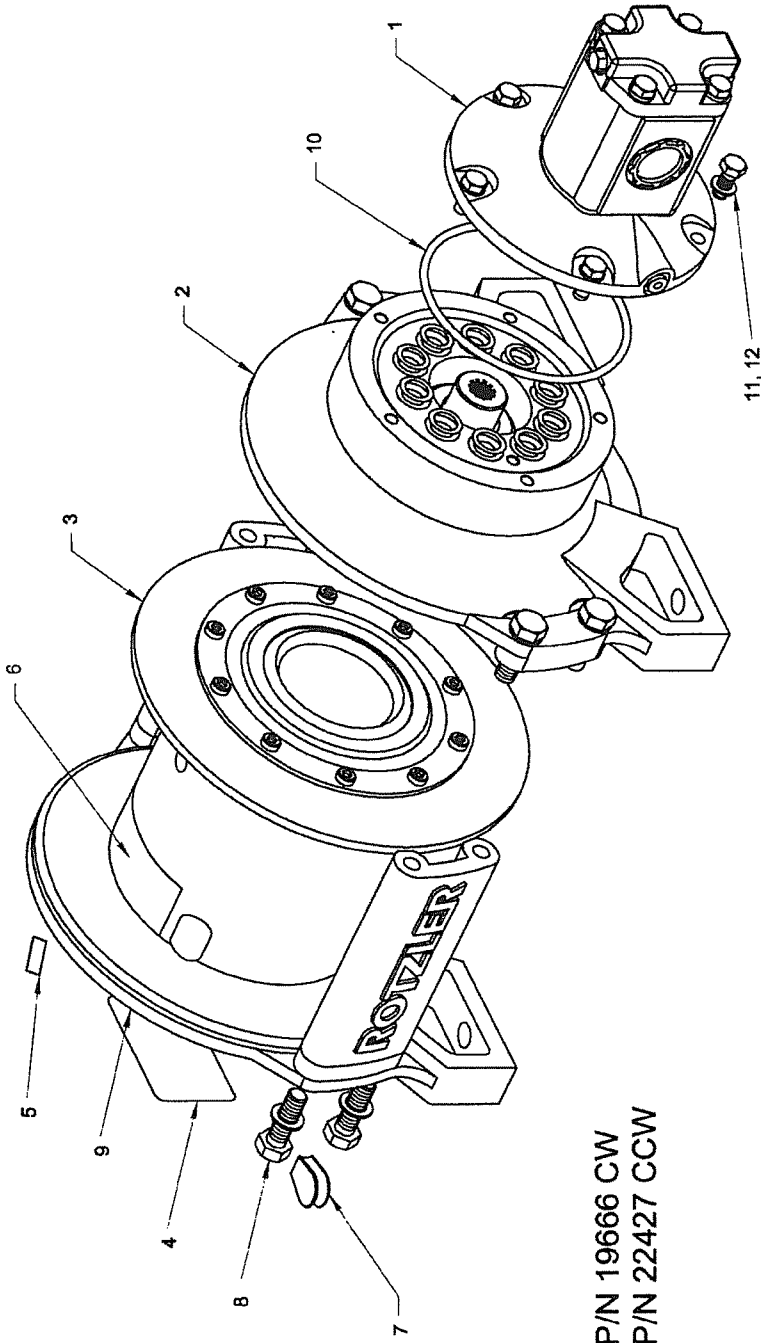

P/N 19666 CW  
P/N 22427 CCW

ITEMS WITH \* HAVE DETAIL DRAWINGS

#	PN	DESCRIPTION	QTY	#	PN	DESCRIPTION	QTY	#	PN	DESCRIPTION	QTY
1	RZ*M.TH2.CW	MOTOR ASSEMBLY TH2 CW	1	5	RZ**220-077	LABEL, NUMBER	1	9	RZ*220-022	WASHER, M14 DIN 433 PLATED	8
2	RZ*P.TH2.CW	PRIMARY ASSEMBLY TH2 CW	1	6	RZ**220-079	LABEL, ROTATION, CW	1	10	RZ*220-044	SEAL, O-RING #2-163	1
3	RZ*F.TH2	FINAL ASSEMBLY TH2	1	7	RZ**220-067C	CABLE WEDGE, TH2	1	11	RZ*220-032	SCREW, HHC M10 X 1.25-25MM GR8	5
4	RZ*220-065	LABEL, IDENTIFICATION	1	8	RZ*220-062	SCREW, HHC M14 X 2.00-40MM GR8	8	12	RZ*220-068	WASHER, M10 DIN 433 PLATED	5

	Houston TX (713)-688-5533 www.liftmoore.com	DWG, WINCH PARTS TH2 ROTZLER TH2 EXPLODED VIEW	DRAWING NO. <b>50530-B</b>
	DRWN BY: JC DATE: 2/23/07		

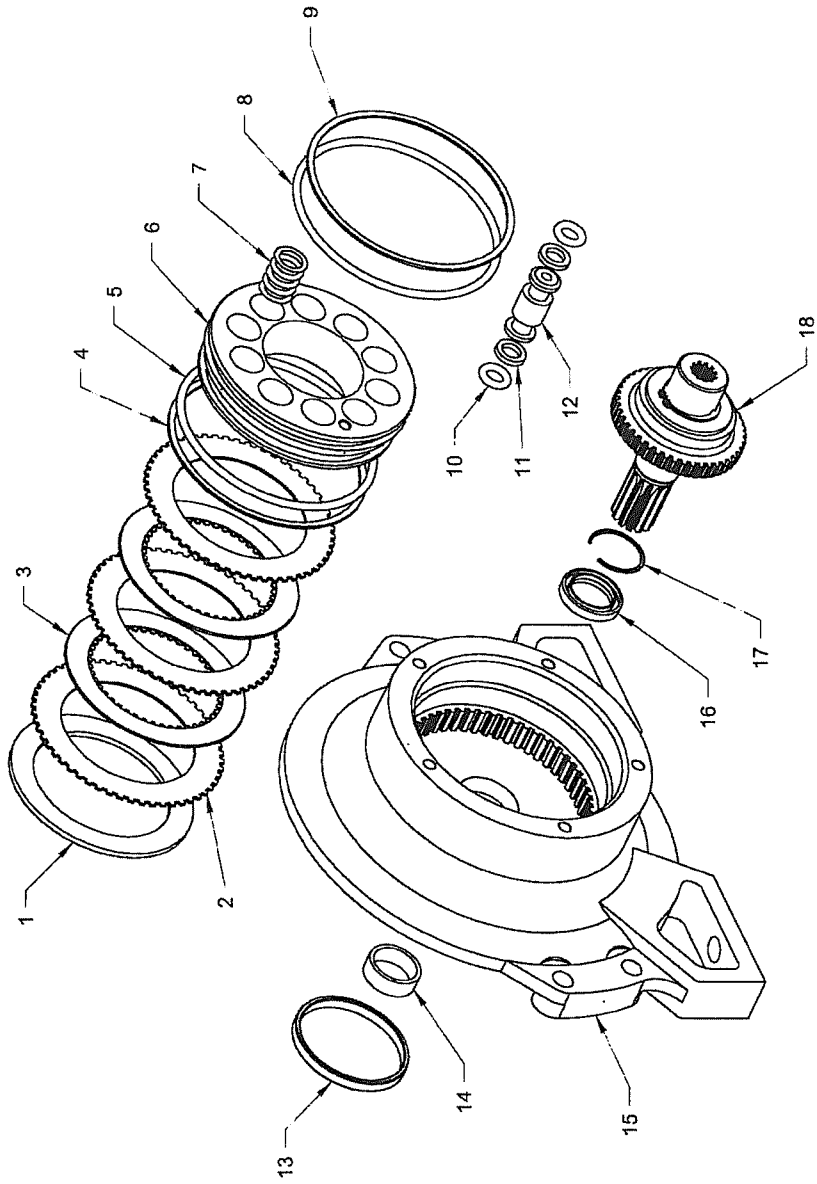

ITEMS WITH \* HAVE DETAIL DRAWINGS

#	PN	DESCRIPTION	QTY	#	PN	DESCRIPTION	QTY	#	PN	DESCRIPTION	QTY
1	RZ*220-015	BRAKE LOCATOR, TH2	1	8	RZ*220-043	SEAL, O-RING, #2-357	1	15	RZ*220-002	BASE, PRIMARY, TH2	1
2	RZ*220-038	BRAKE SEPARATOR, TH2	3	9	RZ*220-042	SEAL, BACKUP RING, #8-357	1	16	RZ*220-035	SEAL, BRAKE SHAFT, TH2	1
3	RZ*220-039	BRAKE DISC, TH2	2	10	RZ*220-047	SEAL, O-RING, #2-008	2	17	RZ*220-081	RETAINER, SPIROLOX #UR-162	1
4	RZ*220-040	SEAL, BACKUP RING, #8-356	1	11	RZ*220-048	SEAL, BACKUP RING, #8-008	2	18	C.TH2.CW	ASSEMBLY, CLUTCH, TH2-CW	1
5	RZ*220-041	SEAL, O-RING, #2-356	1	12	RZ*220-045	BRAKE CONDUIT, TH2	1	NOT SHOWN: RZ*220-093 WINCH SEAL KIT			
6	RZ*220-011	BRAKE PISTON, TH2	1	13	RZ*220-058	SLEEVE, ROTARY SHAFT SEAL, TH2	1				
7	RZ*220-016	SPRING, TH2	10	14	RZ*220-066	BEARING, SLEEVE, TH2	1				

	Houston TX (713)-688-5533 www.liftmoore.com	DWG, WINCH BRAKE PARTS TH2 ROTZLER	DRAWING NO. <b>50529-A</b>
	DRWN BY: S/JN DATE: 6/17/03		

CIRCUIT NUMBER AND DESCRIPTION		
COLOR	LENGTH	CONNECTIONS FUNCTION
RED	25"	P12B.1 P2-R.1 ROT CW
RED/BLK	25"	P12B.2 P2-RA.1 ROT CCW
GRN/BLK	21"	P12B.3 P2-XA.1 EXT OUT
ORN/BLK	21"	P12B.4 P2-XA.1 EXT IN
GRN	11"	P12B.5 P2-U.1 UP LIMIT SW
ORN	23"	P12B.6 P2-LA.1 BOOM DWN
BLU	19"	P12B.7 P2-HA.1 HOIST UP
BLK	19"	P12B.8 P2-HA.1 HOIST DWN
WHT/BLK	21"	P12B.9 P2-P.1 PROP
GRN	20"	P2-U.2 P2-L.1 BOOM UP
BRN	14"	P12A.1 TR-2 GRND
WHT	16"	P12A.2 J5C CAN HI
GRN	16"	P12A.3 J5D CAN LOW
YEL/BLK	11"	P12A.4 P2-ATB.2 ATB
BLU/BLK	11"	P12A.5 P2-PS.2 PRESS SW
RED	13"	P12A.12 P6.2 PWR
RED	12"	P6.3 P2-ATB.1 PWR, ATB
RED	12"	P6.4 P2-PS.1 PWR, PS
RED	17"	P6.5 J5A PWR, CAN
BRN	18"	J5.B TRC-2 CAN GRND
BLK	8"	P12A.11 BLUJFEM HORN 12V

BRN	5"	P12C.1 TR-1 MAIN GROUND
BRN	17"	P12C.2 P2-H.2 HOIST UP VAL GND
BRN	17"	P12C.3 P2-HA.2 HOIST DN VAL GND
BRN	21"	P12C.4 P2-L.2 ELEV UP VAL GND
BRN	21"	P12C.5 P2-LA.2 ELEV DWN VAL GND
BRN	19"	P12C.6 P2-XA.2 EXT OUT VALVE GND
BRN	19"	P12C.7 P2-X.2 EXT IN VALVE GND
BRN	23"	P12C.8 P2-RA.2 ROT. CCW VALVE
BRN	23"	P12C.9 P2-R.2 ROT. CW VALVE
BRN	19"	P12C.10 P2-P.2 PROP. GRND
BRN	20"	P12C.11 BF HORN GND

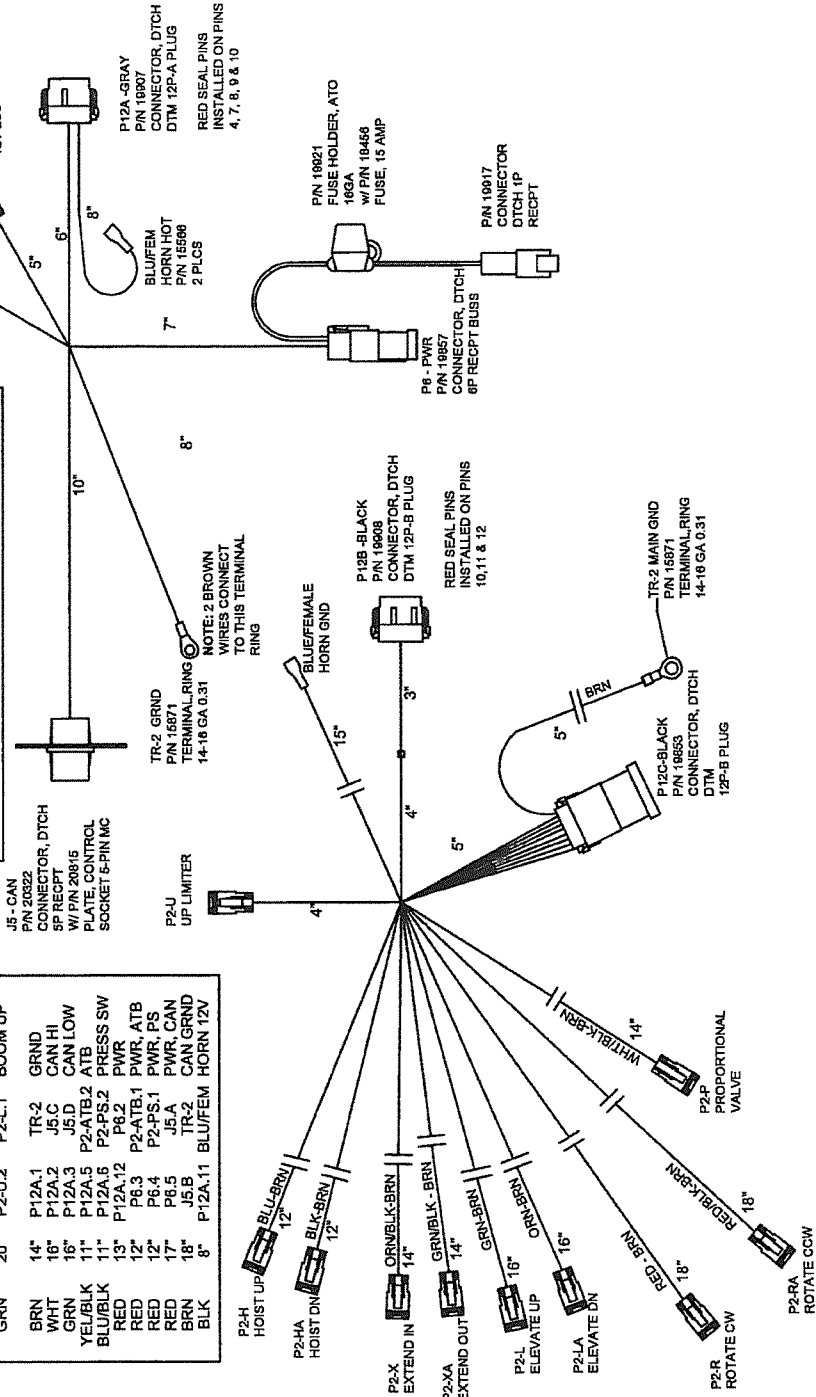

DRAWING NO. 25362-0

EWH, DTCH HYD XP 72100 KTG  
HORN OUTPUT, DTCH VALVES

DRWN BY: JE  
DATE: 11/29/12

Houston TX  
(713)-688-5533  
www.liftmore.com



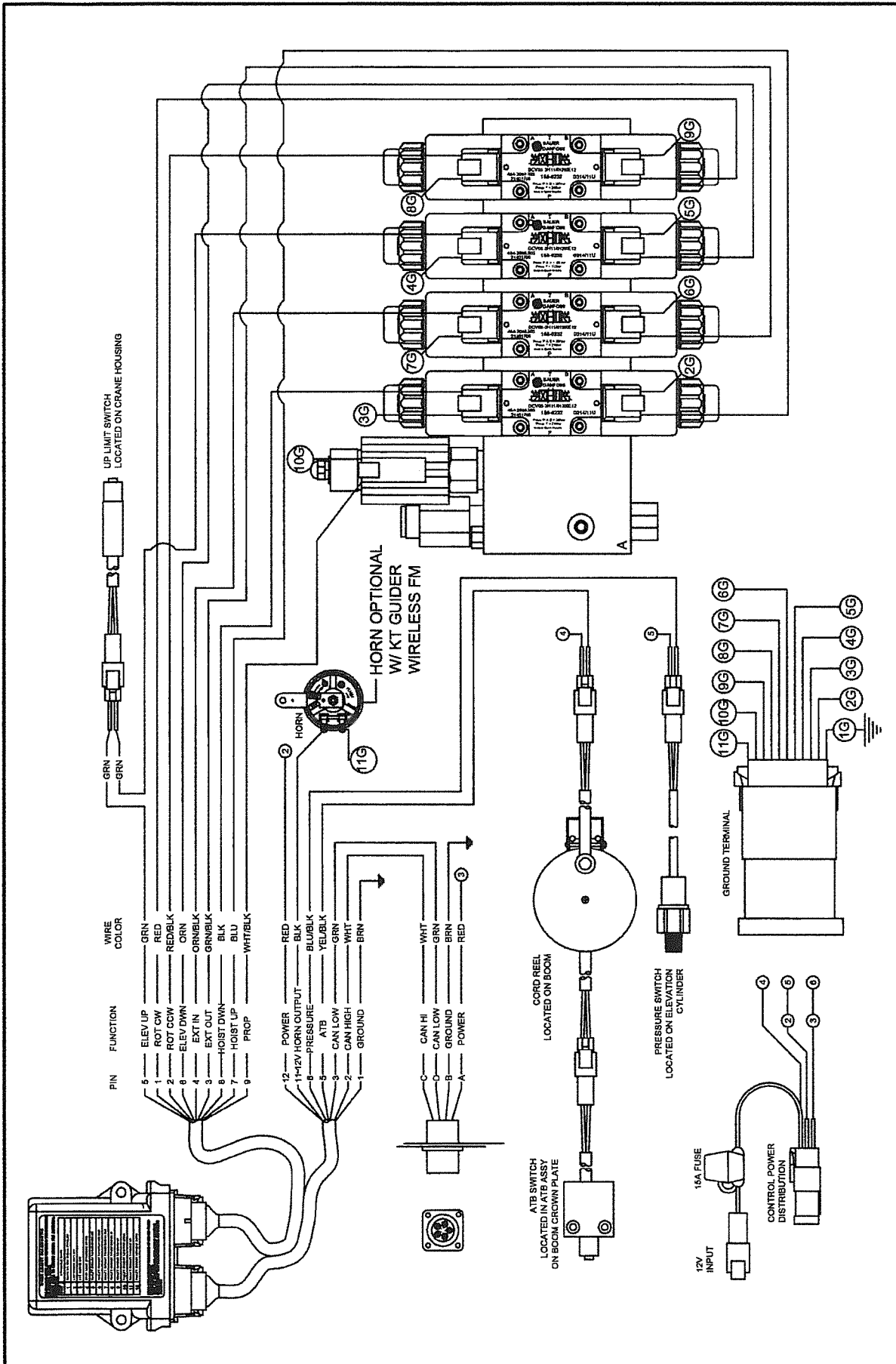

DRAWING NO. 50823-0

SCHEM, ELEC WIRING KTG XP  
SAUER DANFOSS VALVES

DRWN BY: JE  
DATE: 7/24/12

Houston TX  
(713)-688-5533  
www.liftmore.com



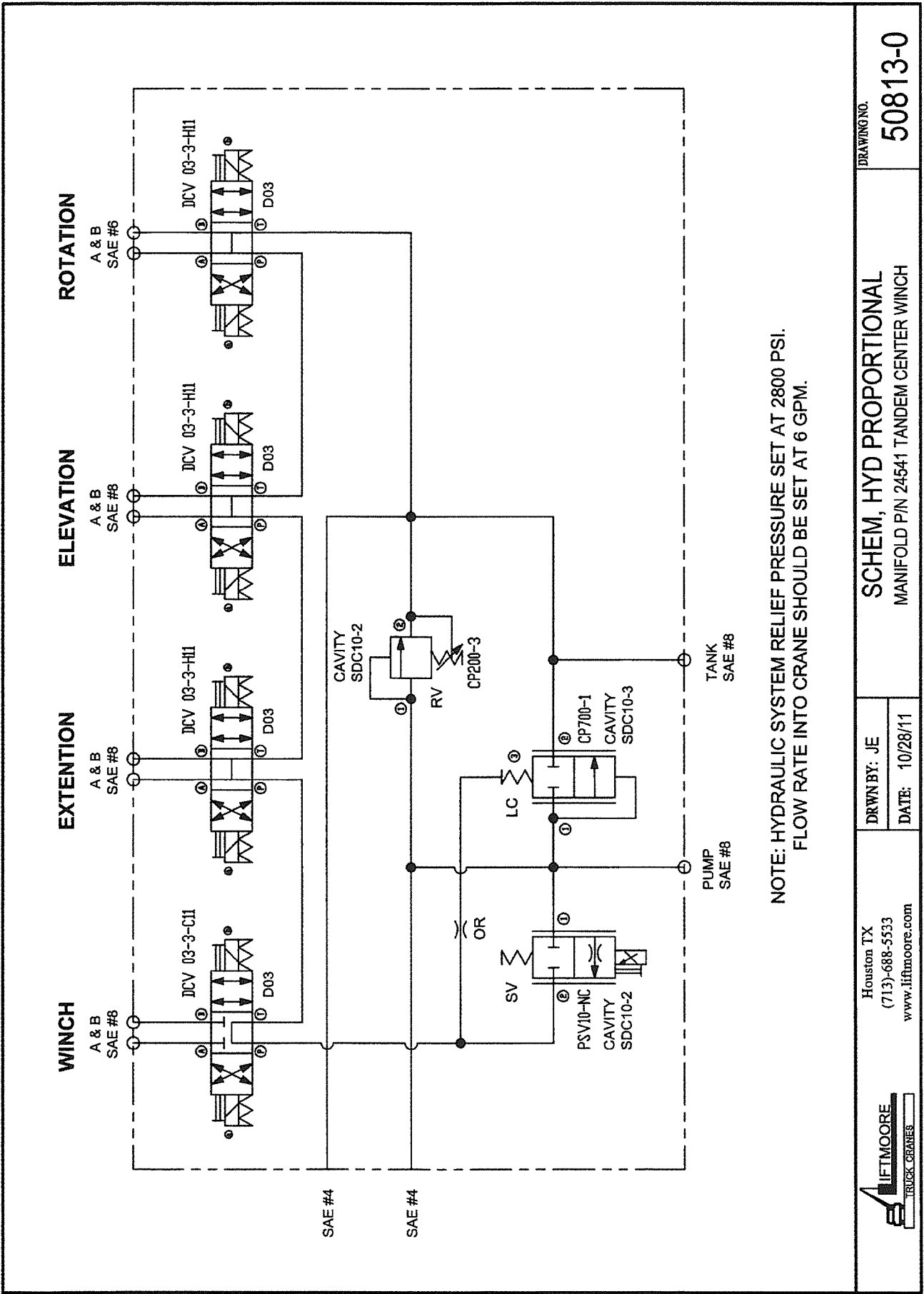

DRAWING NO.

50813-0

SCHEM, HYD PROPORTIONAL  
MANIFOLD P/N 24541 TANDEM CENTER WINCH

DRWN BY: JE  
DATE: 10/29/11

Houston TX  
(713)-688-5533  
www.liftmoore.com



NOTE: HYDRAULIC SYSTEM RELIEF PRESSURE SET AT 2800 PSI.  
FLOW RATE INTO CRANE SHOULD BE SET AT 6 GPM.

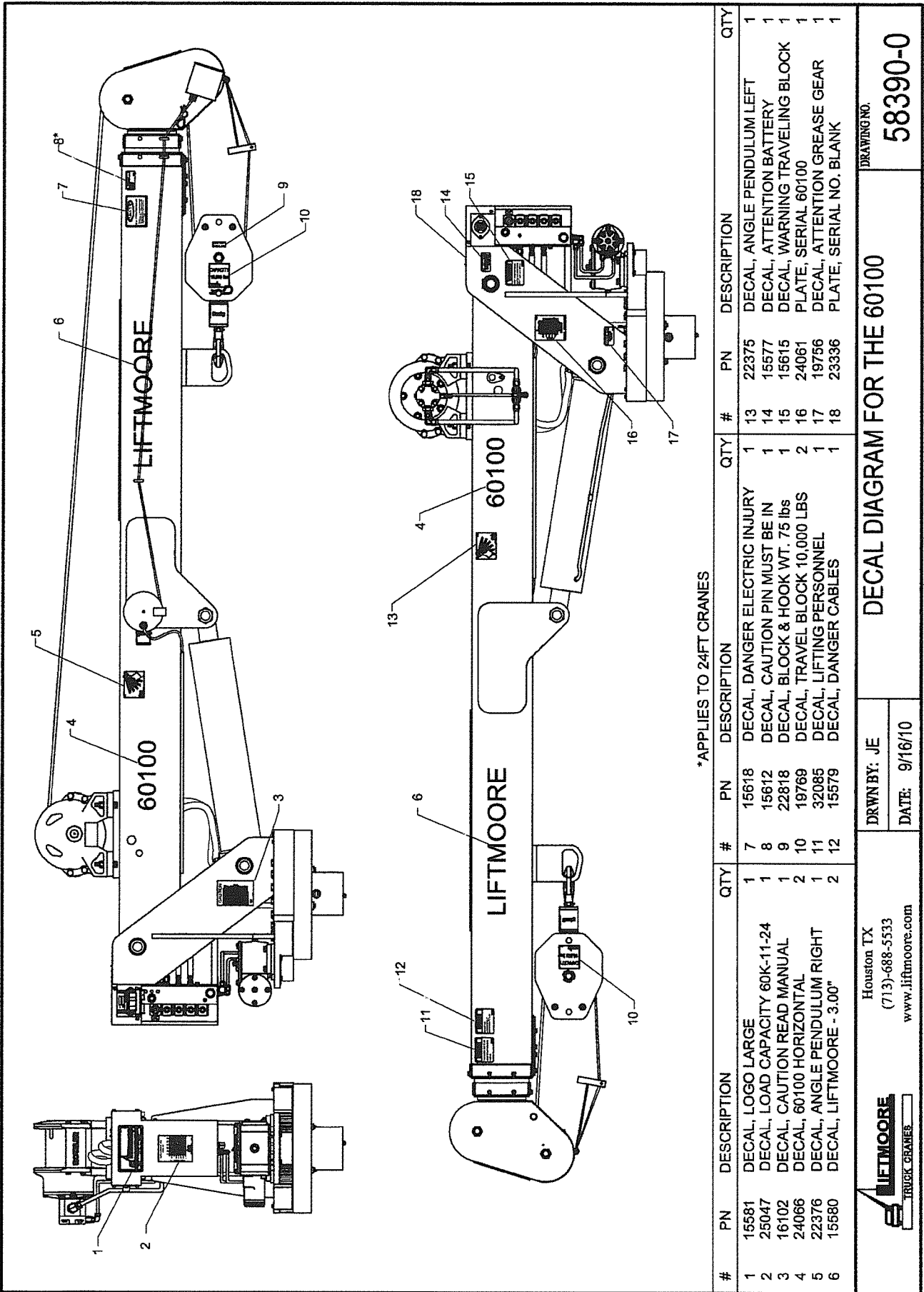

\*APPLIES TO 24FT CRANES

#	PN	DESCRIPTION	QTY	#	PN	DESCRIPTION	QTY	#	PN	DESCRIPTION	QTY
1	15581	DECAL, LOGO LARGE	1	7	15618	DECAL, DANGER ELECTRIC INJURY	1	13	22375	DECAL, ANGLE PENDULUM LEFT	1
2	25047	DECAL, LOAD CAPACITY 60K-11-24	1	8	15612	DECAL, CAUTION PIN MUST BE IN	1	14	15577	DECAL, ATTENTION BATTERY	1
3	16102	DECAL, CAUTION READ MANUAL	1	9	22818	DECAL, BLOCK & HOOK WT. 75 lbs	1	15	15615	DECAL, WARNING TRAVELING BLOCK	1
4	24066	DECAL, 60100 HORIZONTAL	2	10	19769	DECAL, TRAVEL BLOCK 10,000 LBS	2	16	24061	PLATE, SERIAL 60100	1
5	22376	DECAL, ANGLE PENDULUM RIGHT	1	11	32085	DECAL, LIFTING PERSONNEL	1	17	19756	DECAL, ATTENTION GREASE GEAR	1
6	15580	DECAL, LIFTMOORE - 3.00"	2	12	15579	DECAL, DANGER CABLES	1	18	23336	PLATE, SERIAL NO. BLANK	1

Houston TX  
(713)-688-5533  
www.liftmoore.com

DRWN BY: JE

DATE: 9/16/10

DECAL DIAGRAM FOR THE 60100

DRAWING NO. 58390-0

THIS DRAWING INTENTIONALLY LEFT BLANK

FOR FUTURE ADDITIONS

OR

A PART OR FEATURE IS NOT APPLICABLE TO THIS CRANE

DRAWING NO.

DRWN BY:

DATE:

Houston TX  
(713)-688-5533  
[www.liftmoore.com](http://www.liftmoore.com)





## **LIFTMOORE LIMITED WARRANTY**

### Parts and Structural

Liftmoore, Inc. warrants each LIFTMOORE crane to be free from defects in materials and workmanship for twelve (12) months from the date of delivery to the original customer. Under the terms of this warranty the crane structural components manufactured by LIFTMOORE, Inc. are warranted for thirty-six (36) months from the date of delivery to the original customer. LIFTMOORE, Inc. will repair or replace, as its sole discretion, any equipment or part that is returned f.o.b. to LIFTMOORE, Inc.'s plant at 7810 Pinemont Drive, Houston, Texas 77040, or to one of its authorized dealers, and is found by LIFTMOORE, Inc. or its authorized dealer to have been defective at the time of original delivery.

The foregoing warranty is the exclusive warranty made by LIFTMOORE, Inc. with respect to its cranes and is in lieu of all other warranties. ANY AND ALL OTHER WARRANTIES, EXPRESS OR IMPLIED, INCLUDING ANY WARRANTY OF MERCHANTABILITY OR FITNESS OF ANY CRANE FOR A PARTICULAR PURPOSE OR OPERATION, ARE HERBY EXPRESSLY DISCLAIMED.

The foregoing warranty applies only to LIFTMOORE cranes under normal use and service and does not apply in the event of damage caused by repair or alteration or damage during shipment, accident, negligence, overloading, or misuse, including operator's failure to follow any of the instructions issued with the crane.

This warranty is limited to the original purchaser and is not assignable. In order to submit a claim, the original purchaser must provide a copy of the original invoice for the crane in question within twelve (12) months following the delivery date and within 30 days from the date of repair.

The warranty applies only when the LIFTMOORE crane is used for commercial purposes and does not cover any purchase for use for personal, family or household purposes.

**LIMITATION OF LIABILITY:** LIFTMOORE, Inc.'s liability for any losses or damages resulting from any cause whatsoever, including LIFTMOORE, Inc.'s NEGLIGENCE or from a defective crane irrespective of whether such defects are discoverable or latent, shall in no event exceed the purchase price of the crane to which losses or damages are claimed, or at the election of LIFTMOORE, Inc., the repair or replacement of the defective crane.

In no event shall LIFTMOORE, Inc. be liable for any special, incidental, or consequential damages, including commercial losses or costs of any kind sustained by purchaser or any other person or for any damages for which purchaser may be liable to other persons by reason of any defect in any LIFTMOORE crane or any part thereof.

LIFTMOORE, Inc. reserves the right to make changes in design or construction of its cranes at any time without obligating itself to make such changes on cranes previously manufactured.

No agent, employee, or representative of LIFTMOORE, Inc. has authority to amend or modify the foregoing warranty or to bind LIFTMOORE, Inc. by any other warranty, guaranty, or assumption of liability.

In the event any provision of this warranty is for any reason held ineffective, the remaining provisions shall remain in full force and effect.

Some states do not allow limitations on how long an implied warranty lasts or the exclusion or limitation of incidental or consequential damages, so the above limitations and exclusions may not apply to you. This warranty gives you specific legal rights, and you may also have other legal rights that vary from state to state.



F1442-A  
01/01/2008

HOUSTON, TEXAS  
FAX: (800) 824-5559 (USA & Canada)  
FAX: (713) 688-6324  
PHONE: (713) 688-5533  
[www.liftmoore.com](http://www.liftmoore.com)