

**TABLE OF CONTENTS**  
 USERS MANUAL P/N 25485  
 CRANE 5000WX-20 BAIL ATB E- STOP  
 DTCH VALVE, HORN

**SECTION I  
 GENERAL OPERATION, INSPECTION, AND MAINTENANCE**

CRANE SAFETY RULES .....	F1122-B.....	1-1
INTRODUCTION .....	F1111-D.....	1-3
OPERATING RESTRICTIONS .....	F1112-F.....	1-4
OPERATING PRACTICES.....	F1112-F.....	1-4
INSPECTION AND MAINTENANCE.....	F1113-D.....	1-10
MONTHLY INSPECTION REPORT.....	F1123-B.....	1-12
ANNUAL INSPECTION REPORT .....	F1507-0.....	1-13

**SECTION II  
 CRANE SYSTEMS AND TROUBLESHOOTING**

ON/OFF PENDANT CONTROL SYSTEM .....	F1136-0.....	2-1
KHFM CONTROL SYSTEM .....	F1327-0.....	2-2
SAFETY SYSTEM.....	F1115-F.....	2-3
ELECTRIC HOIST.....	F1258-A.....	2-4
HYDRAULIC SYSTEM .....	F1145-C.....	2-5
TROUBLESHOOTING KHFM CONTROL SYSTEM.....	F1328-A.....	2-7
TROUBLESHOOTING SAFETY SYSTEM.....	F1254-A.....	2-8
TROUBLESHOOTING ELECTRIC HOIST .....	F1259-0.....	2-9
TROUBLESHOOTING HYDRAULIC SYSTEM.....	F1255-B.....	2-11

**SECTION III  
 CRANE SPECIFICATIONS**

LIFTING CAPACITIES .....	F1169-G.....	3-1
POWER FUNCTIONS AND SPEEDS .....	F1169-G.....	3-2
BOLT AND LUBRICATION SPECS.....	F1169-G.....	3-3
CRANE LUBRICATION POINTS .....	F1169-G.....	3-4

**SECTION IV  
 PARTS**

BOX PARTS LIST.....	F2030-A.....	4-1
CRANE ASSEMBLY .....	DWG.25484-C.....	4-2
PENDANT CONTROL.....	DWG.23197-B.....	4-3
RELAY BOX ASSEMBLY.....	DWG.22214-B.....	4-4
TRAVEL BLOCK ASSEMBLY .....	DWG.22529-F.....	4-5
ANTI-TWO BLOCK ASSEMBLY .....	DWG.58404-J.....	4-6
BOOM-BODY ASSEMBLY .....	DWG.25483-B.....	4-7
ELEVATION CYLINDER ASSEMBLY .....	DWG.24233-B.....	4-8
BODY ASSEMBLY .....	DWG.23824-F.....	4-9
MANIFOLD ASSEMBLY.....	DWG.22069-E.....	4-10
HYDRAULIC PUMP.....	DWG.23200-A.....	4-11
BASE-HOUSING ASSEMBLY .....	DWG.23823-B.....	4-12
ROTATION SPEED REDUCER.....	DWG.20232-0.....	4-13

**TABLE OF CONTENTS**  
USERS MANUAL P/N 25485  
CRANE 5000WX-20 BAIL ATB E- STOP  
DTCH VALVE, HORN

BOOM ASSEMBLY – 20 FT .....	DWG.25482-B .....	4-14
BOOM OUTER ASSEMBLY – 20 FT .....	DWG.23186-B .....	4-15
BOOM INNER ASSEMBLY – 20 FT .....	DWG.25481-A .....	4-16
WINCH .....	DWG.18884-D .....	4-17
WINCH PARTS LIST .....	DWG.18884-D .....	4-18
ELECTRICAL SCHEMATIC .....	DWG.50810-A .....	4-19
DECAL DIAGRAM .....	DWG.58298-C .....	4-20
WARRANTY .....	F1442-A	

## CRANE SAFETY RULES

### CAUTION!

1. READ AND UNDERSTAND OPERATOR'S MANUAL.
2. INSPECT VEHICLE AND CRANE, INCLUDING ITS OPERATION BEFORE DAILY USE.
3. USE THIS EQUIPMENT ONLY ON SOLID LEVEL GROUND WITH OUTRIGGERS OR JACKSTANDS PROPERLY SET.
4. BEFORE OPERATING THE CRANE REFER TO MAXIMUM LOAD CHART ON CRANE FOR OPERATING LOAD LIMITS.
5. BE SURE LOAD BEING LIFTED IS WITHIN SAFE WINCH CAPACITY AS WELL AS SAFE CRANE CAPACITY. MULTI-PART LINE OPERATION IS REQUIRED WHEN SINGLE LINE LOAD CAPACITY OF WINCH IS EXCEEDED.
6. DO NOT OPERATE, WALK, OR STAND UNDER THE BOOM OR ANY SUSPENDED LOAD.
7. ALWAYS PAY OUT LOAD LINE BEFORE EXTENDING BOOM. WIRE ROPE DAMAGE AND / OR BREAKAGE MAY OCCUR.
8. BOOM MUST BE IN ITS REST BEFORE MOVING VEHICLE.
9. BOOM TIP MUST BE DIRECTLY OVER THE LOAD BEFORE ANY LIFTING IS STARTED. DO NOT DRAG LOADS WITH THIS CRANE.
10. MAINTAIN THIS CRANE AS REQUIRED IN THE OWNER'S MANUAL.
11. DO NOT ALLOW PERSONNEL TO RIDE ON THE LOAD LINE, LOAD, OR BOOM OF THIS CRANE.
12. IT IS UNLAWFUL TO OPERATE THIS EQUIPMENT WITHIN TEN FEET OF HIGH VOLTAGE LINE



F1122-B  
05/12/08

HOUSTON, TEXAS  
FAX: (800) 824-5559 (USA & Canada)  
FAX: (713) 688-6324  
PHONE: (713) 688-5533  
[www.liftmoore.com](http://www.liftmoore.com)

THIS PAGE INTENTIONALLY LEFT BLANK



F1122-B  
05/12/08

HOUSTON, TEXAS  
FAX: (800) 824-5559 (USA & Canada)  
FAX: (713) 688-6324  
PHONE: (713) 688-5533  
[www.liftmoore.com](http://www.liftmoore.com)

## INTRODUCTION

This crane is a powerful machine designed to lift and move heavy loads. There are many hazards associated with these operations. Liftmoore has designed this crane to be as safe as possible but -

**IT IS THE OPERATOR'S RESPONSIBILITY TO PREVENT ACCIDENTS!**

This takes pre-planning, attention, and knowledge of basic principles and rules. Even if you have used similar cranes, reading this manual in its entirety will help prevent damage, injury, or even loss of life; benefits well worth the short amount of time it takes to read these pages.

### REGULATORY AUTHORITY

Use of this crane is governed by OSHA 29 CFR 1910.180 and may be governed by other federal, state, or local regulations.

**IT IS THE OPERATOR'S RESPONSIBILITY TO UNDERSTAND AND COMPLY WITH ALL APPLICABLE REGULATIONS GOVERNING THE OPERATION, INSPECTION, AND MAINTENANCE OF THIS CRANE.**

Personnel should be trained, tested, and certified, as recommended by OSHA and ANSI standards, before operating this crane.

### USING THIS MANUAL

This manual assumes that the crane is mounted on a typical service body type or similar truck, which is powered by the vehicle electrical or hydraulic system, and is controlled by either the standard pendant control or FM radio control sold by Liftmoore, Inc.

This manual is supplied to provide basic guidelines for the safe use, routine maintenance, and general inspections of this crane.

This manual is supplied to provide basic guidelines for the safe use, routine maintenance, and general inspections of this crane.

Laws, regulations, standards, or policies may be more restrictive than this manual. If a conflict exists for any limit or condition, the safest or most prohibitive shall be used. Under no circumstances shall the load, moment, or stability ratings be exceeded.

Pay particular attention to the following:

**WARNING!** – Draws attention to hazards, conditions, or procedures that if not observed could result in injury or death.

**CAUTION!** – Draws attention to hazards, conditions, or procedures that if not observed could result in damage to the crane, load, or other equipment. Equipment failure could in turn lead to injury or death.

**NOTE!** – Draws attention to conditions or procedures that are essential to emphasize.

For questions, interpretations, or to report errors, please contact Liftmoore, Inc, Engineering Dept.



F1111-D  
09/30/09

HOUSTON, TEXAS  
FAX: (800) 824-5559 (USA & Canada)  
FAX: (713) 688-6324  
PHONE: (713) 688-5533  
[www.liftmoore.com](http://www.liftmoore.com)

## OPERATING RESTRICTIONS

### DUTY CYCLE

For Electric Cranes the duty cycle time should be limited to 10%. This is limited by heat buildup in the motors and declining charge in the batteries. (Installing extra batteries near the crane helps keep the voltage at maximum.) (applies to Electric pump and winch only)

### PERSONNEL

LIFTING OR MOVING OF PERSONNEL IS STRICTLY PROHIBITED! This crane was neither designed nor intended to lift personnel. Under no circumstances should anyone be allowed to ride on the crane, line, or load. All non-essential personnel must be kept away when using the crane. The load must never be moved over people, nor must anyone be allowed to pass or stand under a suspended load.

### ELECTRICAL LINES

Consult ANSI B30.5 for operating procedures, minimum safe distances, and prohibited zones when working around electrical lines or poles.

When operating near electrical power lines, the crane must be positioned so that the distance from the crane to the lines or poles is equal to or greater than the length of the fully extended boom plus the minimum safe distance required.

All parts of the crane, line, and load must be kept a minimum safe distance from electrical power lines and poles. This distance is 10 feet for electrical lines carrying 50kV or less.

**UNDER NO CIRCUMSTANCES SHOULD A CRANE BE OPERATED UNDER ELECTRICAL POWER LINES.**

### REQUIRED CLEARANCE FOR NORMAL VOLTAGE IN OPERATION NEAR HIGH-VOLTAGE POWER LINES AND OPERATION IN TRANSIT WITH NO LOAD AND BOOM OR MAST LOWERED

Normal Voltage, kV (phase to phase)	Minimum required Clearance ft (m) [note (1)]
<b>Operation Near High Voltage Power Lines</b>	
Up to 50	10 (3.05)
Over 50 to 200	15 (4.60)
Over 200 to 350	20 (6.10)
Over 350 to 500	25 (7.62)
Over 500 to 750	35 (10.67)
<u>Over 750 to 1,000</u>	<u>45 (13.72)</u>
<b>Operation in Transit With no Load and Boom or Mast Lowered</b>	
Up to 0.75	4 (1.22)
Up to 0.75 to 50	6 (1.83)
Up to 50 to 345	10 (3.05)
Up to 345 to 750	16 (4.87)
<u>Up to 750 to 1,000</u>	<u>20 (6.10)</u>

#### NOTE:

- (1) Environmental conditions such as fog, smoke, or precipitation may require increased clearances.

## OPERATING PRACTICES

### SETUP

**POSITION** The vehicle must be positioned so that the load is kept as close to the crane base as possible to reduce the moment on the crane. Consideration must be given to starting and ending position as well as firmness and slope of the ground and any obstructions.

**OUTRIGGERS** The outriggers or jackstands must be firmly set and the vehicle as level as possible. This will reduce the stresses on the rotation drive and keep the load off the vehicle's suspension. Keep in mind that the weight on the vehicle will shift as the crane and load is rotated.

**MANUAL BOOM EXTENSION** If the manual extension part of the boom is



needed, it must be extended and the boom pin placed in the required position. Insert the pin and replace the pin's hairpin keeper before attempting to lift any load.

**LOAD LIMIT** The operator must understand the crane load chart. The operator must ensure that the load is within the load limits over the entire range which it will be moved. Be sure to include the weight of any lifting devices including the travel block.

The load limit chart is attached to the side of the crane to aid the operator.

The boom angle indicator and chart aids the operator in determining the load capacity at various boom angles and extensions. It also gives the load limit at that configuration.

**STABILITY** A stability chart must be posted near the crane. The operator must understand the stability chart. The crane may be de-rated over some areas of its operating radius.

**TRAVEL BLOCK** The operator must determine if the load is within the single line compatibility of the winch or if a multi-part line configuration is needed.

**REEVING** Ensure the proper routing of the rope through the sheaves and travel block. The rope must lie in the sheave groove and must not rub against any metal objects.

Ensure the rope is correctly wound on the winch drum. The crane assembly drawing will indicate if the rope must be wound over the top or bottom of the drum. The rope must never contact any part of the winch mounting.

### **WARNING!**

If the winch winding direction is reversed the brake will not work and the load will fall.

## **ATTACHING THE LOAD**

**POSITION** The boom tip must be moved over the load before lifting so that it will be lifted straight up.

### **CAUTION!**

Never drag a load with the crane. Dragging a load puts very high stresses on the crane for which it was not designed.

**ROPE** Check the rope condition to ensure it is not frayed or damaged. Ensure that the rope is not kinked and that it does not contact any sharp edges or make any sharp bends.

If using double line configuration, ensure that the lines are not twisted.

### **CAUTION!**

Never wrap the hoist rope around the load! Serious damage to the rope WILL occur.

**HOOK** Always make sure the load is applied to the throat of the hook. Never use a bent hook.

### **CAUTION!**

Always lift with the throat of the hook. Never lift with the load applied to the tip of the hook. Doing so will bend the hook.

**SLINGS** If the load does not have a lifting eye, use a nylon, chain, or other type of sling designed for lifting and rated for loads greater than that being lifted.

**BALANCE** Ensure the load will be secure and balanced when lifted. Ensure that the load cannot shift in the sling and that the sling cannot slide across the hook should the load become unbalanced.



F1112-F  
7/5/12

HOUSTON, TEXAS  
FAX: (800) 824-5559 (USA & Canada)  
FAX: (713) 688-6324  
PHONE: (713) 688-5533  
[www.iftmoore.com](http://www.iftmoore.com)

## 1-6

### LIFTING THE LOAD

Before lifting, ensure that the load is free from all mountings and is no way attached or stuck to anything.

Ensure that at least five full wraps remain on the winch drum at all times.

Test the winch brake by lifting the load a few inches and ensuring that it does not slip.

### HOLDING THE LOAD

The operator must keep the load in sight at all times once it is lifted.

The operator must never leave the controls once the load is lifted.

The operator must ensure that no one is allowed to pass or stand under a suspended load.

### CAUTION!

Never move the vehicle with a suspended load. Doing so will put dynamic loads on the crane for which it was not designed.

### MOVING THE LOAD

Before moving the load, make sure the path is free of any obstructions or people.

Avoid sudden accelerations or stops. Speeds must be kept to a minimum, especially rotation, to keep the load from swinging.

Avoid sudden reversing of direction. Do not reverse direction while the load is still moving.

Make sure that no part of the crane, boom, or load makes contact with any obstruction or comes within a minimum of ten feet from any electrical line.

### TRANSIT

While in transit, the crane must be stowed, preferably in a boom rest. The crane must be prevented from rotating and the hook prevented from swinging.



F1112-F  
7/5/12





HOUSTON, TEXAS  
FAX: (800) 824-5559 (USA & Canada)  
FAX: (713) 688-6324  
PHONE: (713) 688-5533  
[www.liftmoore.com](http://www.liftmoore.com)

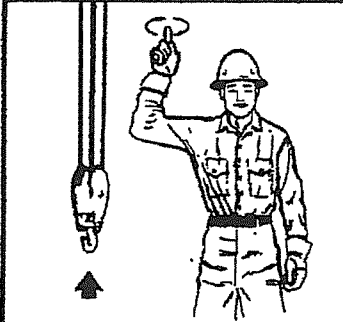
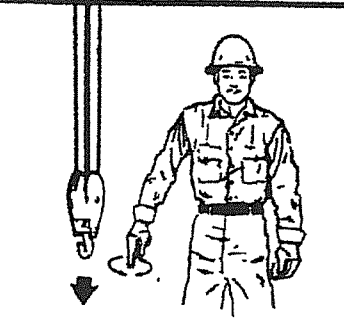
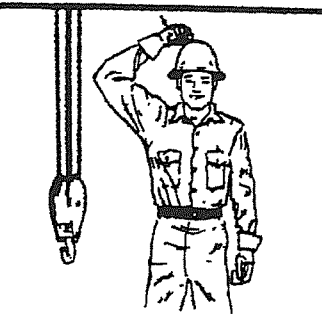
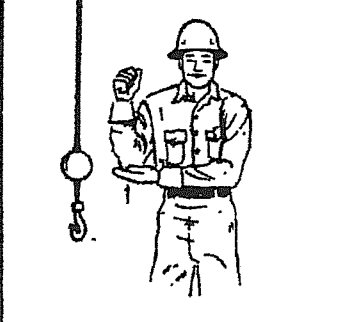
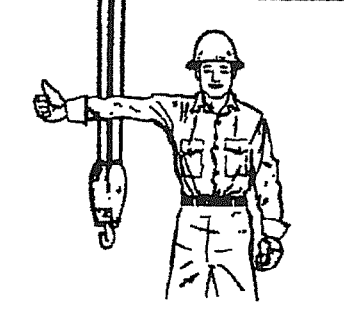
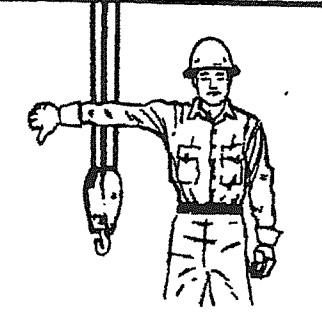
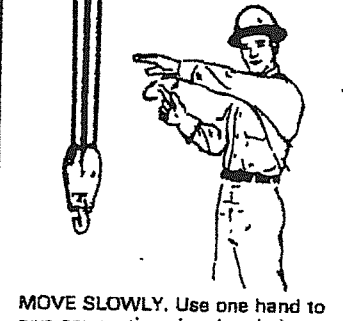
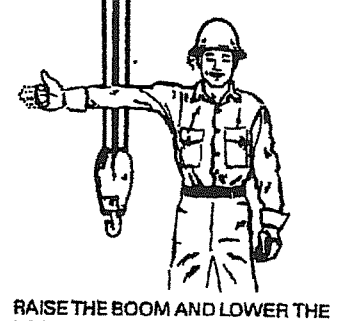
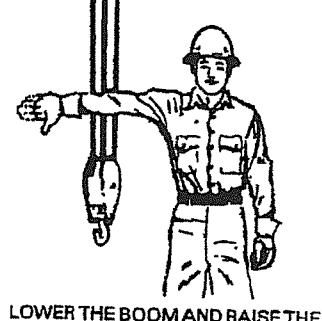

### Standard Hand Signals for Controlling Crane Operations

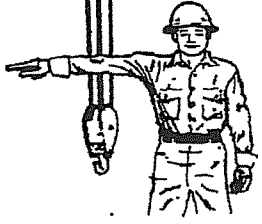
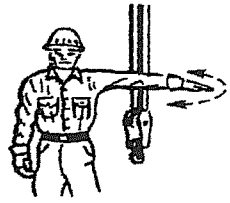
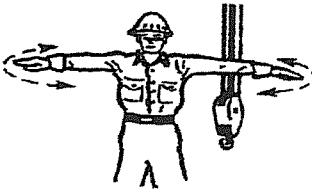
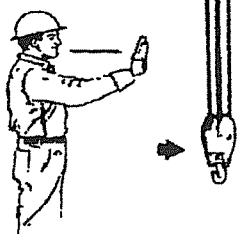
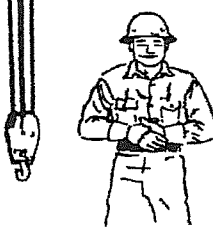
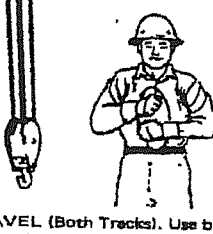
 <p><b>HOIST.</b> With forearm vertical, forefinger pointing up, move hand in small horizontal circle.</p>	 <p><b>LOWER.</b> With arm extended downward, forefinger pointing down, move hand in small horizontal circle.</p>	 <p><b>USE MAIN HOIST.</b> Tap fist on head; then use regular signals.</p>
 <p><b>USE WHIPLINE (Auxiliary Hoist).</b> Tap elbow with one hand; then use regular signals.</p>	 <p><b>RAISE BOOM.</b> Arm extended, fingers closed, thumb pointing upward.</p>	 <p><b>LOWER BOOM.</b> Arm extended, fingers closed, thumb pointing downward.</p>
 <p><b>MOVE SLOWLY.</b> Use one hand to give any motion signal and place other hand motionless in front of hand giving the motion signal. (Hoist slowly shown as example.)</p>	 <p><b>RAISE THE BOOM AND LOWER THE LOAD.</b> With arm extended, thumb pointing up, flex fingers in and out as long as load movement is desired.</p>	 <p><b>LOWER THE BOOM AND RAISE THE LOAD.</b> With arm extended, thumb pointing down, flex fingers in and out as long as load movement is desired.</p>

Standard Hand Signals for Controlling Crane Operations (Cont'd)

 <p><b>SWING.</b> Arm extended, point with finger in direction of swing of boom</p>	 <p><b>STOP</b> Arm extended, palm down, move arm back and forth horizontally</p>	 <p><b>EMERGENCY STOP.</b> Both arms extended, palms down, move arms back and forth horizontally.</p>
 <p><b>TRAVEL.</b> Arm extended forward, hand open and slightly raised, make pushing motion in direction of travel.</p>	 <p><b>DOG EVERYTHING.</b> Clasp hands in front of body.</p>	 <p><b>TRAVEL (Both Tracks).</b> Use both fists in front of body, making a circular motion about each other, indicating direction of travel, forward or backward. (For land cranes only.)</p>
 <p><b>TRAVEL (One Track)</b> Lock the track on side indicated by raised fist. Travel opposite track in direction indicated by circular motion of other fist, rotated vertically in front of body. (For land cranes only.)</p>	 <p><b>EXTEND BOOM (Telescoping Booms).</b> Both fists in front of body with thumbs pointing outward.</p>	 <p><b>RETRACT BOOM (Telescoping Booms).</b> Both fists in front of body with thumbs pointing toward each other.</p>



HOUSTON, TEXAS  
 FAX: (800) 824-5559 (USA & Canada)  
 FAX: (713) 688-6324  
 PHONE: (713) 688-5533  
 www.liftmoore.com

## Standard Hand Signals for Controlling Crane Operations (Cont'd)

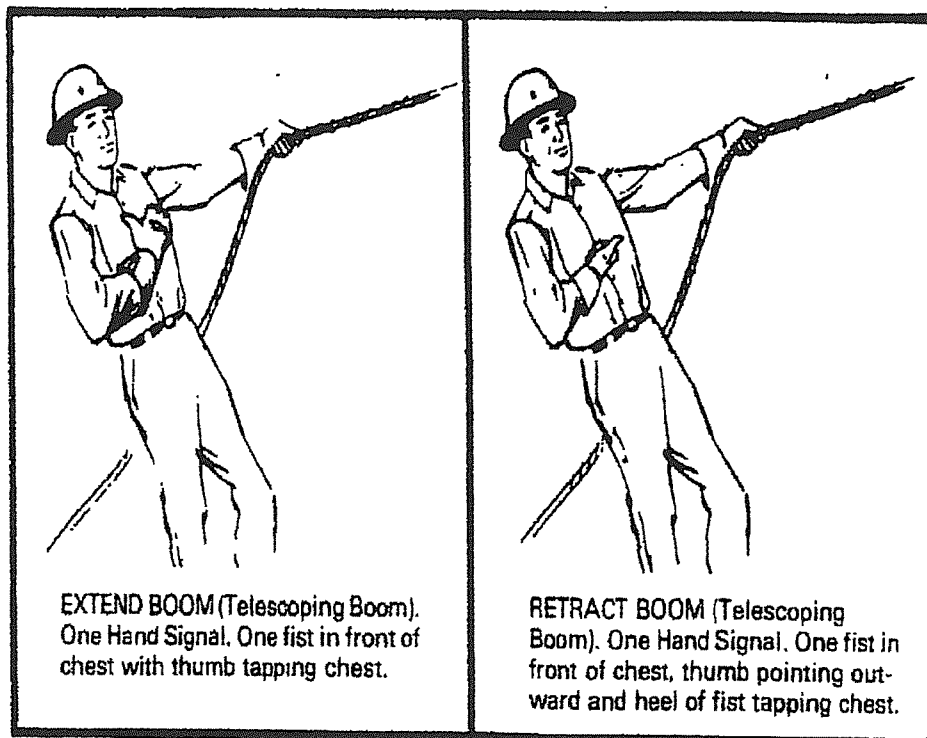

HOUSTON, TEXAS  
FAX: (800) 824-5559 (USA & Canada)  
FAX: (713) 688-6324  
PHONE: (713) 688-5533  
[www.liftmoore.com](http://www.liftmoore.com)

## INSPECTION AND MAINTENANCE

OSHA and ANSI require frequent and periodic inspections. Records of these inspections must be kept readily available. Liftmoore requires periodic maintenance to ensure proper operation and prolonged life of the crane.

### INSPECTION

#### DAILY INSPECTION

OSHA 29CFR 1910.180 (d)(2)(i) requires the following be checked daily prior to use:

- All control mechanisms for maladjustment interfering with proper operation as well as for excessive wear of components and contamination by lubricants or other foreign matter.
- All safety devices for malfunction. This should include the anti-two block and pressure switch.
- Deterioration or leakage in air or hydraulic systems.
- Crane hooks with deformations or cracks. For hooks with cracks or having more than 15 percent in excess of normal throat opening or more than 10 deg. twist from the plane of the unbent hook.
- Electrical apparatus for malfunctioning, signs of excessive deterioration, dirt, and moisture accumulation. This should include the battery terminals, master disconnect switch, electrical swivel
- The wire rope shall be replaced if any of the following conditions are noted:

- Kinking, crushing, bird-caging, or other damage
- Reductions from nominal diameter of more than one-sixty-fourth inch for diameters up to and including five-sixteenths inch, one-thirty-second inch for diameters three-eighths inch to and including one-half inch.
- Thimble is not in place or is damaged
- Any evidence of heat damage
- Six or more randomly distributed broken wires in 1 lay
- Three or more broken wires in 1 strand in 1 lay

#### MONTHLY INSPECTION

A thorough inspection of all ropes in use shall be made at least once a month and a certification record which includes the date of inspection, the signature of the person who performed the inspection and an identifier for the ropes shall be prepared and kept on file where readily available. All inspections shall be performed by an appointed or authorized person. Any deterioration, resulting in appreciable loss of original strength shall be carefully observed and determination made as to whether further use of the rope would constitute a safety hazard. Some of the conditions that could result in an appreciable loss of strength are the following:

- Reduction of rope diameter below nominal diameter due to loss of core support, internal or external corrosion, or wear of outside wires.
- A number of broken outside wires and the degree of distribution of concentration of such broken wires.



- Worn outside wires.
- Corroded or broken wires at end connections.
- Corroded, cracked, bent, worn, or improperly applied end connections.
- Severe kinking, crushing, cutting, or unstranding.

#### PERIODIC INSPECTION

An Annual Inspection Form is included in this manual. OSHA 29CFR 1910.180 (d)(2)ii) requires periodic inspections of this crane. Liftmoore recommends an annual inspection using the included form.

#### MAINTENANCE PRECAUTIONS

The crane should be maintained monthly for safety reasons and to reduce stress on the crane.

#### WARNING!

Never perform any maintenance while the crane has any type of load on it. Use the manual operation procedure to lower the load if necessary.

#### WARNING!

Hydraulic cylinders may have high pressure stored in them even after hydraulic power is removed.

The counterbalance and pilot operated check valve in the cylinder will always hold some pressure in the cylinder. Slightly extending the cylinder then retracting a small amount will relieve most of the pressure in the cylinder. **DO NOT DEADHEAD THE CYLINDER!** This will store the maximum amount of pressure in the cylinder. Care should be taken when either valve is removed from the cylinder as some pressure will still remain.

After any maintenance has been performed the crane shall not be operated until all guards have been reinstalled, all safety

devices reactivated, and maintenance equipment removed.

**LUBRICATION** Refer to the crane specification section for the periodic maintenance schedule and type of lubrication required.

**BOLTS** Bolts may loosen over time due to vibration; therefore they should be checked periodically. If bolts need to be replaced, make sure they are replaced with bolts of equal or greater strength. Check the periodic maintenance schedule (Crane Specification Section) for bolt specification and torque.

#### NOTE!

Sheave and boom and cylinder pivot bolts are not standard bolts. The shank and thread length of these bolts have been modified so that they do not pivot on the threads. Consult the parts section of this manual for part numbers of these bolts.

#### OTHER MAINTENANCE

Refer to parts drawings for any specific maintenance or adjustment procedures such as hydraulic winch brake, rotation drive gear set adjustment, Ect.



**MONTHLY INSPECTION REPORT**

Crane Model No. \_\_\_\_\_ Serial Number \_\_\_\_\_

- Are Boom Hitch Pins and Keepers in place? Yes \_\_\_\_\_ No \_\_\_\_\_
- Wire Line Hook with Safety Latch Working? Yes \_\_\_\_\_ No \_\_\_\_\_
- Is Hook OK, (Not bent)? Yes \_\_\_\_\_ No \_\_\_\_\_
- Is Thimble on Wire Rope OK? Yes \_\_\_\_\_ No \_\_\_\_\_
- Is Traveling Block in use? Yes \_\_\_\_\_ No \_\_\_\_\_
- Is Wire Rope OK, not kinked or frayed? Yes \_\_\_\_\_ No \_\_\_\_\_
- Are all Boom Sections straight? Yes \_\_\_\_\_ No \_\_\_\_\_
- Are Sheave Bolts in place and tight? Yes \_\_\_\_\_ No \_\_\_\_\_
- Do all Sheaves rotate easily? Yes \_\_\_\_\_ No \_\_\_\_\_
- Are Mounting Bolts tight? Yes \_\_\_\_\_ No \_\_\_\_\_
- Is Anti Two-Block functioning properly? Yes \_\_\_\_\_ No \_\_\_\_\_
- Is Boom Angle Indicator in place and functioning and is Chart legible? Yes \_\_\_\_\_ No \_\_\_\_\_
- Are Cylinder Mounting Bolts secure? Yes \_\_\_\_\_ No \_\_\_\_\_
- Are Winch Mounting Bolts tight? Yes \_\_\_\_\_ No \_\_\_\_\_
- When stopped does winch drift less than 1.0 Inches? Yes \_\_\_\_\_ No \_\_\_\_\_
- Is Load Chart in place and easily read? Yes \_\_\_\_\_ No \_\_\_\_\_
- Are functions on Pendant operating correctly? Yes \_\_\_\_\_ No \_\_\_\_\_
- Is Hydraulic Reservoir full? Yes \_\_\_\_\_ No \_\_\_\_\_
- Is Outrigger straight and functioning? Yes \_\_\_\_\_ No \_\_\_\_\_

Any items checked 'No' must be repaired before using this crane.



F1123-B  
03/26/07

HOUSTON, TEXAS  
 FAX: (800) 824-5559 (USA & Canada)  
 FAX: (713) 688-6324  
 PHONE: (713) 688-5533  
 www.iftmoore.com

## ANNUAL CRANE CERTIFICATION (29CFR1910.180)

OWNER \_\_\_\_\_

MODEL NUMBER \_\_\_\_\_ SERIAL NUMBER \_\_\_\_\_

DATE \_\_\_\_\_

Check the following:

 Crane Mounting Bolts (Torque) Winch mounting Bolts (Torque) Boom mounting bolts Cylinder mounting bolts Cracks on boom (Check when extended) Extension Pads not worn excessively Cracks on housing Weld cracks on boom Weld cracks on housing Boom swing approximately one inch or less at boom tip when retracted Hydraulic leaks Hoses not chafed or cracked

Sheaves not cracked

 Boom Tip Traveling Block Sheaves not worn excessively Boom Tip Traveling Block Sheaves rotate freely Boom Tip Traveling Block

*Load Chart in place and legible*

*Boom angle chart in place and legible*

*Labels in place (See manufacturer's chart)*

*Crane Hook Throat Opening within 15% of standard*

*Crane Hook not bent more than 10 degrees from plane*

*Hook safety latch operating properly*

*Booms pin(s) and Keeper(s) in place (Manual Extension Section)*

*Wire Rope removed if the following occurs:*

*Six randomly distributed broken wires in one lay or three broken wires in one strand in one lay.*

*Wear of one-third the original diameter of outside individual wires.*

*Kinking, crushing, bird-caging or any other damage.*

*Evidence of heat damage.*

*Reduction from nominal diameter of more than one sixty-fourth inch for diameters to five-sixteenths diameter and one-thirty-second inch for diameters three-eighths to one-half inch.*

*Wire Line installed as manufacturer requires.*

*Protective covers in place*

*Grease crane as required*

*Check fluid level*

*Winch*

*Gearbox*

*Reservoir*



*Control system for proper operation*

*Winch Up and Down*

*Boom Up and Down*

*Boom In and Out*

*Rotation CW and CCW*

*Anti Two-Block (Required on Power Extendible Cranes) interrupts:*

*Boom Down*

*Boom Out*

*Winch Up*

*Boom Up stopped by Up Limit Switch*

*Outrigger or jackstand operable*

*Outrigger crushing decal in place*

*Outrigger and Jackstand operates properly*

*Boom rest in place and used*

*Load Sensor trips when overloaded*

*Winch Down does not overrun when stopped*

*Crane stability chart in place and visible.*

*I certify that I have performed the above tests and that any deficiencies were corrected and now comply as above.*

*Signed* \_\_\_\_\_

*Print Name* \_\_\_\_\_

*Company* \_\_\_\_\_

*Address* \_\_\_\_\_

*City* \_\_\_\_\_ *State* \_\_\_\_\_

*I:\FORMS\F1507-0.doc*

F1507-0  
6/26/12

THIS PAGE INTENTIONALLY LEFT BLANK



HOUSTON, TEXAS  
FAX: (800) 824-5559 (USA & Canada)  
FAX: (713) 688-6324  
PHONE: (713) 688-5533  
[www.liftmoore.com](http://www.liftmoore.com)

## ON/OFF PENDANT CONTROL SYSTEM

Liftmoore cranes are electrically controlled using the hand-held pendant, which works in conjunction with the crane control module to operate powered functions.

### PENDANT

All user inputs are facilitated by the remote pendant control. The pendant consists of pistol grip housing, wire, and control plug. The control plug mates with the crane control socket.

### CRANE CONTROL MODULE

For ON/OFF (non-proportional) cranes the crane control module contains only the limiting system control board. It is a single printed circuit board enclosed in a rugged, sealed housing. Status LEDs are located on the circuit board to aid in troubleshooting.

The limiting system control is part of the safety system. Refer to that section for more information.

### OPERATION

Plug the pendant into the crane control socket. Ensure all pins are straight and free of dirt, moisture, and corrosion. Turn the locking ring approximately 1/3 turn until it clicks into the locked position.

Select the function switch and direction as indicated on the label for the desired operation.

## CARE AND MAINTENANCE

The pendant control is designed to be as rugged and maintenance free as possible; however, care should be used in handling and storage as it is expensive to replace.

Follow these simple practices:

- Keep the pendant out of the weather
- When not in use, store the pendant inside the vehicle or body compartment
- Do not wrap the wire too tightly as internal damage to the wires may result
- Do not place sharp or heavy object on the cord

### NOTE!

The pendant is designed to be weatherproof not waterproof. It may be used in inclement weather, but if left outside or where water can puddle, water can seep inside.

Maintenance should be limited to routine inspection of the plug, wire, and fasteners.



## KMFM CONTROL SYSTEM

KMFM – KAR-TECH MINI FM

The Liftmoore FM control system Model KMFM is a microprocessor-based radio remote control system, which allows wireless crane control. The receiver connects to the standard crane control socket, just like the wired pendant, so it is easily retrofitted and does not prevent use of the standard wired pendant.

### RECEIVER

The receiver features encapsulated electronics for weather resistance and LEDs for user diagnostics. It is mounted to the crane and connects to the crane control socket. Upon user input, the receiver energizes the applicable function valves and/or solenoids, just as the wired pendant does.

### TRANSMITTER

The transmitter is a pocket sized, hand held unit featuring an on/off power switch, push button switches for each function, and two diagnostics LEDs. It is powered by 2 AA Alkaline batteries and includes a power saving feature, which turns itself off if idle for 2 minutes

### DIAGNOSTIC LEDS

There is a green and a red LED located inside the receiver and on the transmitter.

The green LED will blink every ½ second if there is communication between the transmitter and the receiver. It will blink every second if there is no communication.

The transmitter's red LED will blink once every second if the batteries are low and need to be replaced.

Error codes are indicated by a number of flashes of the red LED. For example, 4 blinks and a pause means output number 3 has a problem. See the trouble shooting section for more information.

## MOUNTING

### MOUNTING

The FM receiver should be mounted so that it is protected from physical damage. It should be as high as possible with the antenna pointing upwards. A temporary mounting method, such as magnets or Velcro, is recommended so that it may be removed when not in use.

### OPERATION

POWER ON- PRESS AND HOLD POWER BUTTON UNTIL GREEN LIGHT BEGINS FLASHING.

POWER OFF- PRESS AND HOLD POWER BUTTON UNTIL GREEN & RED LIGHTS STOP FLASHING.

### REPLACEMENT OF COMPONENTS

Each transmitter is encoded with a digital ID that is programmed to its specific receiver. The receiver then only accepts signals from that transmitter so multiple cranes may be operated in the same vicinity without interference. If either component needs to be replaced, the receiver must be programmed to accept the new transmitter ID. Contact Liftmoore, Inc. for more information.

### RETROFIT

The system design allows for easy retrofit. The only crane modification required is the simple addition of a ground wire to the control socket. This does not prevent the use of the wired pendant.



## SAFETY SYSTEM

The safety system is designed to help prevent damage to the crane that would be caused by overload or two-blocking. The system consists of a load sensor, anti-two block device (optional on smaller, electric cranes), and limiting system control board.

When the applicable switch detects an overload or two-block condition, the limiting system will prevent activation of winch up, boom down, and extend out since these directions would cause damage. Winch down, boom up, extend in, and power rotation will still function so that the crane can be moved to a safe configuration.

### CAUTION!

Never de-activate or override safety functions. Doing so can result in serious damage to the crane and possibly injury or death.

### LOAD SENSOR

A pressure activated switch in the elevation cylinder acts as a load sensor. This switch is normally closed and opens at the preset pressure corresponding to the load rating of the crane.

### CAUTION!

The load sensor will not function when the elevation cylinder is fully retracted and is inaccurate when the boom is below horizontal.

### CAUTION!

The operator must never rely strictly on the load sensor to determine overload conditions. The load and load limits must always be known and adhered to.

### ANTI-TWO BLOCK

The anti-two block device (optional on smaller electric cranes), mounted on the boom crown plate, consists of a normally open switch actuated by a lever. A weight is attached to the lever and holds the switch

closed. If the weight is lifted by the hook or travel block the switch opens.

The power and signal wires are wired through the cord reel, which is in turn wired to the ATB switch.

### LIMITING SYSTEM CONTROL

The limiting system control prevents output of winch up, boom down and extend out if it is not receiving a signal from either the ATB or load sensor.

The ATB does not trip boom down when winch is mounted on the boom.

There is a one second delay before deactivation of boom down when the load sensor is tripped to prevent false readings caused by pressure spikes.

## MISCELLANEOUS

### UP LIMIT SWITCH

The up limit switch prevents the elevation cylinder from reaching full extension. If the elevation cylinder were to "dead-head", the resulting pressure would activate the load sensor, preventing boom down. The boom would then have to be lowered using the manual operation buttons on the solenoid valves.

### CIRCUIT BREAKER, FUSE

For electric cranes a 150 Amp circuit breaker is supplied with the crane. It should be installed as close to the battery as possible. For hydraulic cranes a 10 Amp blade type fuse is supplied.

### DISCONNECT SWITCH

A power disconnect switch is supplied with the crane. Power to the crane should be turned off whenever not in use. This is to prevent inadvertent or unauthorized use and will help prevent corrosion at electrical connections.



## ELECTRIC HOIST

Series Wound Motor

This Liftmoore crane features an electrically driven planetary gear hoist. The hoist is powered in both directions and features an automatic internal brake to positively control the load. It is permanently lubricated.

### MOTOR

The hoist motor is a direct current (DC), reversible motor. It is Series Wound – the field coils (terminals F1 & F2) and armature (terminal A) must be connected in series. The fourth, unmarked terminal is ground.

### CAUTION!

The hoist motor is rated for intermittent duty. Duty cycle is limited to 5 minutes in 30 to allow the hoist to cool. Extended use can damage the motor and brake.

### THERMAL SWITCH

The motor incorporates a normally closed thermal switch to help prevent damage. When the motor heats up the switch will open, preventing hoist up. When the motor cools, the switch will close automatically.

### CAUTION!

When the thermal switch opens, hoist down will continue to function, but will continue to build heat. If the load cannot be safely lowered quickly, discontinue use until the motor cools. Motor and brake damage may result.

### BRAKE

The hoist features a single acting, overrunning brake. It automatically activates to hold the load and assist in lowering the load.

### WARNING!

Overheating the brake may result in permanent damage and possible failure of the brake. Replace any damaged components before continuing use.

### WARNING!

The hoist brake only functions in one direction. If the hoisting direction is reversed by reversing the rope winding direction the brake will not hold and the load will fall. Serious injury or death could result.

The brake is factory set and is not adjustable. If the brake fails to hold the load or if downward drift becomes excessive the brake must be replaced.

### DIRECTIONAL CONTROL

A sealed contactor that incorporates three double pole-double throw relays controls motor direction. The contactor allows for directional control and provides dynamic braking in the neutral position.

The power, ground, and motor wires are connected to the top bolted terminals, which are clearly labeled. Signal wires are connected to the 3 male spade disconnect terminals on the front of the contactor.

Signal voltage, controlled by the pendant, energizes the applicable relays and controls the direction of the current flow through the field windings, F1 & F2, then directs current through the armature, A.

When the DOWN (right) terminal is energized, current flows from motor terminal F1 to F2, then to A. Energizing the UP (Left) terminal directs current from F2 to F1, then to A. The center terminal is the ground for UP coil. The DOWN coil is internally grounded.



F1258-A  
4/05/07

HOUSTON, TEXAS  
FAX: (800) 824-5559 (USA & Canada)  
FAX: (713) 688-6324  
PHONE: (713) 688-5533  
[www.liftmoore.com](http://www.liftmoore.com)

## HYDRAULIC SYSTEM FOR ELECTRIC CRANES

The hydraulic system consists of the hydraulic pump, manifold, solenoid valves, cylinders, motors, and tubing and hoses. Hydraulic power is generated by the electrically driven hydraulic pump on the outside of the housing. The hydraulic system is plumbed in series so that more than one function can be operated simultaneously.

### PUMP

The hydraulic pump assembly consists of a DC permanent magnet electric motor, pump, and reservoir.

The motor is activated by the pump solenoid. The solenoid is energized by the pendant control whenever a hydraulic function is activated.

The pump provides fluid pressure to power hydraulic functions. The system incorporates an adjustable relief valve to prevent damage that can be caused by over pressurizing the system.

Fluid is drawn from and returned to the reservoir. Servicing the hydraulic pump consist of maintaining the oil level. The reservoir should be kept as full as possible to prevent condensation from forming inside the tank. Also ensure the oil is not contaminated by water, dirt, rust, etc. See crane specification sheet for hydraulic oil type.

### SOLENOID VALVES

Each hydraulically operated function is controlled by a 4-way, 3-position open center solenoid valve. It is electrically operated and spring biased to center. A manual operation button is incorporated in the coil-retaining nut. Valves are mounted to the series manifold.

### CYLINDERS

Most hydraulic cylinders are double acting cylinders with integrally mounted counterbalance valve and pilot operated check valves. Refer to the cylinder drawings for specific information.

All cylinders use a counter-balance load holding cartridge valve on the extend port. This valve performs 3 functions:

- Controls the rate of decent when lowering the load
- Keeps load from falling in the event of sudden loss of system pressure, such as when a hose bursts.
- Acts as a relief valve to prevent damage from induced load or thermal expansion.

It allows free flow to extend then blocks flow until opened by pilot pressure to the retract port or when the relief pressure is reached.

Some cylinders utilize a pilot operated check valve on the retract port to prevent the cylinder from creeping out under no load conditions. This valve allows flow into, but prevents flow from the retract port, thus hydraulically locking the cylinder until opened by pilot pressure to the extend port.

### MOTORS

#### THE HYDRAULIC MOTOR USED BY THE ROTATION DRIVE IS A HIGH-TORQUE, LOW-SPEED CONSTANT DISPLACEMENT MOTOR. MANUAL OPERATION

If electrical problems occur the solenoid valves may be operated manually by depressing the manual operation button incorporated in the coil-retaining nut. Using a blunt object such as a bolt or screwdriver handle may be required to assist operation if high pressures are needed. Refer to the manifold drawing for function valves and directions.

If possible, activate the pump by activating a hydraulic function on the pendant. If this does not work, then energize the pump solenoid using a jumper from the hot side of



the solenoid to the coil post where the WHT/BLK wire is connected. If this fails also then battery voltage can be applied directly to the pump motor.

If hydraulic power is lost while a load is suspended, the load can be lowered by decreasing the setting on the counter-balance valve. This should only be done in extreme cases. The valve must be reset before the crane is returned to use.

**WARNING!**

The boom may fall if the adjustment is made too fast. Do not stand where the boom may hit you if it falls. Serious injury or death may result

**WARNING!**

The area between the boom and the cylinder, the boom and the housing, and the cylinder and the housing will change as the boom position changes and could form pinch points. Do not position any part of your body in these areas as it may be pinched or crushed as the boom lowers.

To decrease the setting, loosen the locknut on the valve, then slowly turn the adjustment stem **CLOCKWISE** until the load begins to lower. Count the number of turns so that the valve can be returned to its original setting.

Alternately, a pressure gage must be put on the retract port to adjust the setting so that approx. 1800 PSI is required to lower the boom with no load.

Test the setting by lifting a known load near the moment rating.





# TROUBLESHOOTING KMFM CONTROL SYSTEM

If the crane does not operate, ensure that both the transmitter and receiver are on. Try disconnecting power to the crane receiver then reconnecting.

Run the crane using the wire pendant to confirm that the problem is the wireless unit.

Check that the green transmit light on the transmitter and the green receive light on the receiver light up when a function is selected.

Check for error codes and correct as necessary.

### NOTE!

The green transmit light is located inside the transmitter.

Check that all connectors are secure.

Check for bent pins on the receiver connectors.

If the transmit and receive LEDs are both lit when a function is selected and no error codes are given contact Liftmoore, Inc. for further information.

### Receiver Error Code Chart

	PROBLEM
1	RADIO SIGNAL PROBLEM
2	FAULTY CIRCUIT TO HOIST UP
3	FAULTY CIRCUIT TO HOIST DOWN
4	FAULTY CIRCUIT TO BOOM UP
5	FAULTY CIRCUIT TO BOOM DOWN
6	FAULTY CIRCUIT TO ROTATION CW
7	FAULTY CIRCUIT TO ROTATION CCW
8	FAULTY CIRCUIT TO EXTENSION OUT
9	FAULTY CIRCUIT TO EXTENSION IN
10	FAULTY CIRCUIT TO PUMP RELAY

ERROR CODE NUMBER IS THE NUMBER OF RED LIGHT BLINKS BETWEEN EVERY PAUSE

### Transmitter Error Code Chart

	PROBLEM
1	LOW BATTERY
2	FAULTY CIRCUIT TO HOIST UP
3	FAULTY CIRCUIT TO HOIST DOWN
4	FAULTY CIRCUIT TO BOOM UP
5	FAULTY CIRCUIT TO BOOM DOWN
6	FAULTY CIRCUIT TO ROTATION CW
7	FAULTY CIRCUIT TO ROTATION CCW
8	FAULTY CIRCUIT TO EXTENSION OUT
9	FAULTY CIRCUIT TO EXTENSION IN
10	FAULTY CIRCUIT TO PUMP RELAY

ERROR CODE NUMBER IS THE NUMBER OF RED LIGHT BLINKS BETWEEN EVERY PAUSE.



F1328-A  
4/03/07

HOUSTON, TEXAS  
FAX: (800) 824-5559 (USA & Canada)  
FAX: (713) 688-6324  
PHONE: (713) 688-5533  
www.liftmoore.com

## TROUBLESHOOTING SAFETY SYSTEM

DTC Relay Card

To check functions controlled by the safety system check the status indicators. (See Relay Box Assembly drawing.) If only one of the safety functions is not working, activate that function and check for error codes and/or its output status indicator.

For non-FM systems, if the status indicator lights then the problem is in the wiring or in the solenoid coil. If the light does not illuminate, check the control pendant. If the control pendant is good then the crane control module needs to be replaced.

For FM systems, check for error codes. If none are present, see the FM Troubleshooting section.

If boom out, boom down and winch up are not working, confirm that the control board has power. Confirm that the board is receiving a signal from the ATB and load sensor.

If the error code is active, ensure that the crane is not overloaded and that the ATB lever is holding the switch closed. Check for voltage at the ATB and Load Sensor inputs.

### CHECK LOAD SENSOR SWITCH

If the load sensor input is not receiving voltage, locate the load sensor connector inside the crane housing. The plug side will have a red wire and a gray wire, the receptacle side will have a red and a white wire.

Disconnect and check for continuity between the two pins on the receptacle (switch side). If there is no continuity then the load sensor is bad and needs to be replaced.

### CHECK ATB SWITCH

If the ATB input is not receiving voltage remove the ATB housing cover and disconnect the connector. Check for continuity on the switch side. Lifting the weight should break the continuity. If either of these conditions is incorrect the switch is bad and needs to be replaced.

### CHECK CORD REEL

Check the ATB switch if not done so already. Locate the ATB connector inside the crane housing. The plug side will have a red wire and a black wire. The receptacle side will have a white wire and a black wire.

Disconnect the plug going to the switch. Check for continuity between the two pins on the receptacle. Have someone lift the weight on the ATB and continuity should be broken. If either of these conditions are incorrect then the cord reel is bad and needs to be replaced.

### CHECK POWER TO SAFETY SWITCHES

If the safety switch is good, check for voltage at pin 1 (the red wire) on the plug. If there is no voltage, follow the wire back to the 6-pin power distribution plug, checking for breaks or shorts.

Remove the power distribution receptacle (cap).

### NOTE!

Removing the cap will disconnect power to all electrical components. Be sure to replace the cap before continuing.

Check the cap for bent pins. Check that all wires are fully seated in the plug. If they are not, then remove the green locking wedge and push the wires forward until seated. Reinstall the wedge ensuring that no wires are pushed back.



## TROUBLESHOOTING ELECTRIC HOIST

Series Wound, Contactor Controlled

### IMPORTANT NOTE!

The importance of first physically checking every connection between the battery and the crane cannot be overstressed!

Poor connections or poor grounding account for a large percentage of hoist problems. Time is often wasted chasing other probable causes only to eventually find a loose or corroded connection. **Measuring the voltage is not sufficient.** Often a poor connection will allow enough amperage to operate a meter or test light, but not enough to operate the hoist, which requires very high amperage.

If the problem is random and intermittent then it is almost assuredly a loose or bad connection.

Another common problem is low battery voltage. Even if the battery is good when troubleshooting begins, running the winch can quickly drain a battery. If it can be done safely, it is best to have the vehicle running.

Also check the control socket and plug for bent, corroded, or dirty pins.

### CAUTION!

As the motor approaches stall, due to low voltage or excessive load, a very rapid heat build up occurs which will quickly damage the motor. If the motor is not turning, do not operate the switch for more than a second. Allow the motor to cool between attempts to make it run.

### CAUTION!

Do NOT attempt to run if there is no load on the MOTOR, such as when the motor is removed from the hoist. Motor over-speed will result, which will damage the motor.

## HOIST OPERATES IN ONLY ONE DIRECTION

If the hoist only operates in one direction then the problem is **not** the motor. Swap the control wires on the contactor. Activating the pendant switch in the working direction should now operate the hoist in the previous non-working direction.

**Example:** if hoist up is not working, after swapping the control wires activating the hoist down switch should cause the hoist to go up.

If it does then the hoist and contactor are working correctly and the problem is in the pendant or crane wiring. If it does not then the problem is the contactor or brake.

If the motor tries to turn but stalls then the problem is most likely the brake.

If the control wires were swapped in the previous step, return them to their original positions. Swap the motor field wires labeled F1 and F2. It is usually easiest to swap them at the motor.

Activating the pendant switch in the working direction should now operate the hoist in the previous non-working direction.

**Example:** if hoist up is not working, after swapping the motor wires activating the hoist down switch should cause the hoist to go up.

If it does, then one side of the contactor is not working and it needs to be replaced.

If it does not work, the problem is a brake malfunction. Inspect the brake installation. Correct any problems found. The brake cannot be repaired. Replace if any damage is found.



F1259-0  
10/22/04

HOUSTON, TEXAS  
FAX: (800) 824-5559 (USA & Canada)  
FAX: (713) 688-6324  
PHONE: (713) 688-5533  
[www.liftmoore.com](http://www.liftmoore.com)

## HOIST DOES NOT RUN IN EITHER DIRECTION

If the hoist does not run in either direction then the problem is either lack of power to the control socket or pendant, lack of sufficient power to the motor, the contactor dynamic braking coil, or hoist brake malfunction.

If any other function works or if the contactor clicks when the switch is activated then the control socket is getting power.

If all power connections have not been checked, do so now. Also ensure that the battery still has sufficient power. As a rule of thumb, if it has enough power to start the engine, then it is good.

Once sufficient power is ensured, if there is any indication that the motor is trying to turn but stalls the problem is the brake – have it replaced.

If there is no indication that the motor is trying to turn, attempt to run the motor directly. Disconnect the wire from the F2 terminal at the contactor and touch it to the + terminal. If the motor turns, the contactor is malfunctioning and needs to be replaced. If the motor does not turn then it is malfunctioning and needs to be replaced.

## TESTING THE PENDANT AND CONTROL WIRING

### TESTING THE PENDANT AND CONTROL WIRING

If the problem is narrowed to the control wiring, it is most likely do to a cut or disconnected wire. A visual inspection of the wiring should be made and repairs made as necessary.

Refer to the pendant drawing and schematic for pin function and locations.

If no visual defects are found and if a continuity tester is available, disconnect the pendant and check for continuity between the control socket pin and terminal at the contactor.

Alternately, a piece of wire or metal object may be used to short between the control socket power pin and the socket hoist pin(s). If the hoist operates then the problem is in the pendant.

If not, check for power at the control socket power pin. If there is no power, trace the wiring back, checking each connection until the problem is found. Correct as necessary.

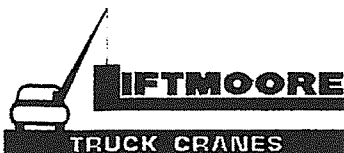

## TROUBLESHOOTING HYDRAULIC PUMP

Electric Pump, 14P Socket

### IMPORTANT NOTE!

The importance of first physically checking every connection between the battery and the crane cannot be overstressed!

Poor connections or poor grounding account for a large percentage of electrical problems. Time is often wasted chasing other probable causes only to eventually find a loose or corroded connection. **Measuring the voltage is not sufficient.** Often a poor connection will allow enough amperage to operate a meter or test light, but not enough to operate the motor, which requires very high amperage.

If the problem is random and intermittent then it is almost assuredly a loose or bad connection.

Another common problem is low battery voltage. Even if the battery is good when troubleshooting begins, running the motor can quickly drain a battery. If it can be done safely, it is best to have the vehicle running.

Also check the control socket and plug for bent, corroded, or dirty pins.

### CAUTION!

As the motor approaches stall, due to low voltage or excessive load, a very

rapid heat build up occurs which will quickly damage the motor. If the motor is not turning, do not operate the switch for more than a second. Allow the motor to cool between attempts to make it run.

### FOAMY FLUID

If the fluid foams then the problem is the pump seal – have it replaced.

### PUMP DOES NOT RUN

If both the pump and winch are not working, the problem is power related or control wiring related. Troubleshoot those areas first.

If the solenoid is actuating it will make a clicking noise. If the solenoid is not clicking, check for power at the coil input (small screw terminal) on solenoid when the Boom Up switch is activated. If there is no power then the problem is the electrical wiring harness or pendant control wiring.(refer. to CONTROL TROUBLESHOOTING CHART).

If the coil is getting power when the switch is activated, but not clicking then the problem is most likely the solenoid.

If the solenoid is clicking check for full power input to the solenoid. Trace the wiring back to the crane input, checking for power at each connection until the problem is found. If full electrical power to the motor is confirmed then the motor is faulty and should be replaced.



F1255-B  
01-10-11

HOUSTON, TEXAS  
FAX: (800) 824-5559 (USA & Canada)  
FAX: (713) 688-6324  
PHONE: (713) 688-5533  
[www.liftmoore.com](http://www.liftmoore.com)

THIS PAGE INTENTIONALLY LEFT BLANK



HOUSTON, TEXAS  
FAX: (800) 824-5559 (USA & Canada)  
FAX: (713) 688-6324  
PHONE: (713) 688-5533  
[www.liftmoore.com](http://www.liftmoore.com)

## SECTION 3 CRANE SPECIFICATIONS

### MODEL 5000 CRANES

MOMENT RATING                    25 000 FT-LBS

MAX SINGLE LINE LOAD        2 500 LBS

MAX DOUBLE LINE LOAD       5 000 LBS

LIFTING CAPACITIES AT VARIOUS LOAD RADII

LOAD RADIUS (FT)	CAPACITY (LBS)
5	5000
8	3125
10	2500
12	2083
14	1823
16	1562
18	1388
20	1250

POWERED FUNCTIONS AND EXPECTED TIMES

WINCH	UP: 2.9 s	DOWN: 2.8 s	1 REVOLUTION
BOOM ELEVATION	UP: 20.0 s	DOWN: 20.2 s	
BOOM EXTENSION	OUT: 28.0 s	IN: 24.5 s	
ROTATION	90°	17.8	

ELECTRICAL REQUIREMENTS

VOLTAGE	12 VDC
FUSE	15 AMP
CIRCUIT BREAKER	150 AMP

NOTE: FUNCTION TIMES ARE BASED ON THESE INPUT VALUES



F1169-G  
9/18/15

HOUSTON, TEXAS  
FAX: (800) 824-5559 (USA & Canada)  
FAX: (713) 688-6324  
PHONE: (713) 688-5533  
[www.liftmoore.com](http://www.liftmoore.com)

PERIODIC MAINTENANCE SCHEDULE		
MODEL 5000 CRANES		
BOLTS		
MOUNTING BOLTS	7/8-9 GRADE 8 TORQUE 600FT-LBS DRY	EVERY 4 MONTHS
BEARING BOLTS	5/8-11 GRADE 8 TORQUE 220FT-LBS DRY	EVERY 4 MONTHS
LUBRICATION		
GREASE FITTINGS	SEE DRAWING 50048	EVERY OTHER WEEK
HYDRAULIC FLUID	STANDARD Chevron AW Hydraulic Oil 46 or equivalent SAE 15 weight oil  COLD WEATHER AW 32 or equivalent SAE 10 weight oil	CHECK DAILY, FILL AS NEEDED
ROTATION GEARBOX	Sunco Prestige 740 EP or NLGI Grade 0	EVERY MONTH
BEARING (ZERK AND TEETH)	Oil Center Research PM 600 Military grease or equivalent Benton Based Grease NLGI Grade 2	EVERY 6 HOURS OF OPERATION



F1169-G  
9/18/15

HOUSTON, TEXAS  
FAX: (800) 824-5559 (USA & Canada)  
FAX: (713) 688-6324  
PHONE: (713) 688-5533  
[www.liftmoore.com](http://www.liftmoore.com)



## CRANE LUBRICATION POINTS

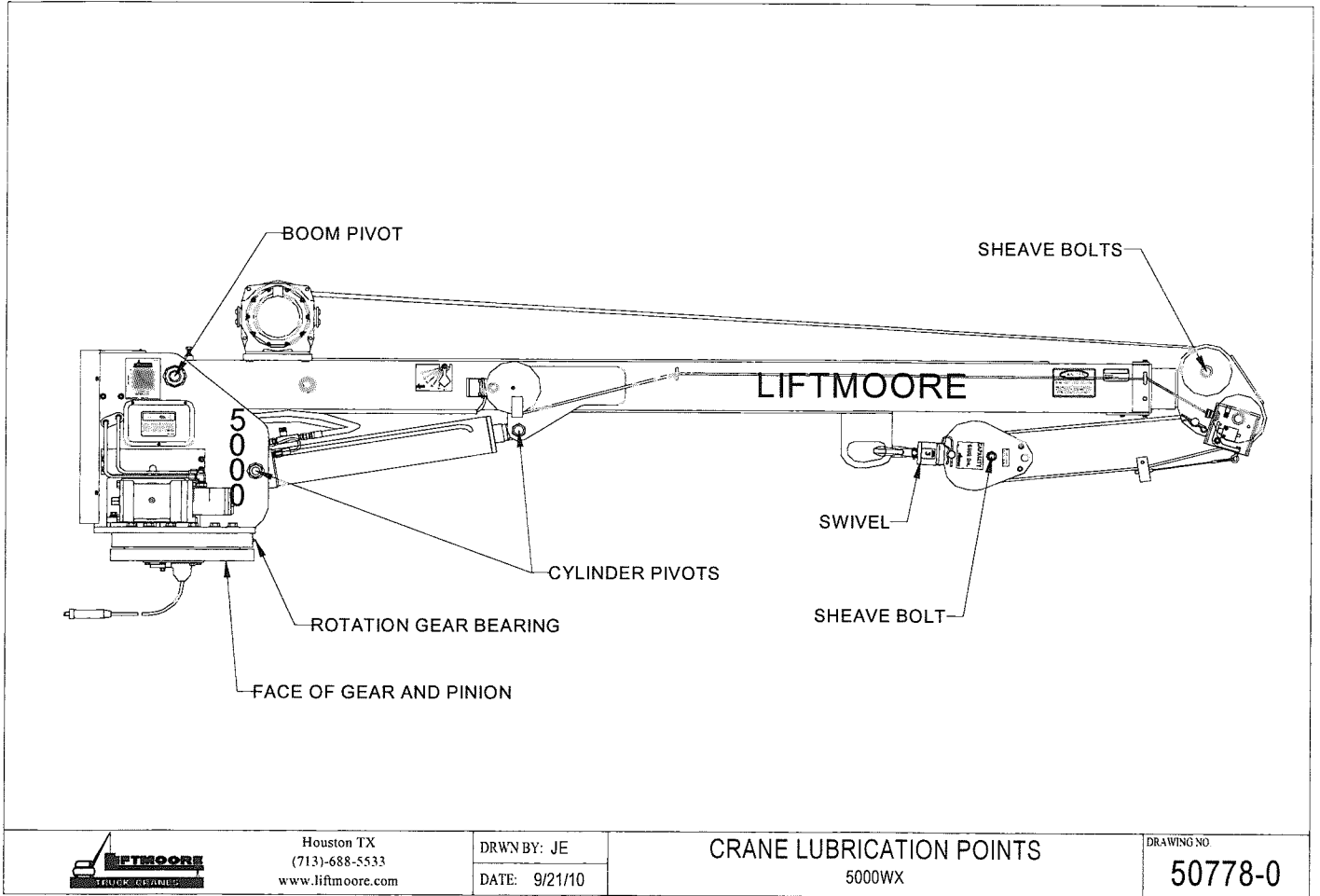

F1169-G  
9/18/15

HOUSTON, TEXAS  
 FAX: (800) 824-5559 (USA & Canada)  
 FAX: (713) 688-6324  
 PHONE: (713) 688-5533  
 www.liftmoore.com

THIS PAGE INTENTIONALLY LEFT BLANK



F1169-G  
9/18/15

HOUSTON, TEXAS  
FAX: (800) 824-5559 (USA & Canada)  
FAX: (713) 688-6324  
PHONE: (713) 688-5533  
[www.liftmoore.com](http://www.liftmoore.com)

## LIST FOR BOX, CRANE PARTS 5000WX-20 HORN

Items with \* have detailed DWG's.

P/N 25486 - BOX, CRANE PARTS 5000WX-20  
ATB LS; E-STOP; HORN

- 1) P/N 25485 – MANUAL, CRANE 5000WX-20.....1pc
- 2) \*P/N 22529 – BLOCK, TRAV ASSY 5.0K LBS/5.3D.....1pc
- 3) P/N 33203 – PIN, HITCH 0.75 X 6.00 W/H-PIN.....1pc
- 4) P/N 16878 – BREAKER, CIRCUIT 150 AMP.....2pc
- 5) P/N 24846 – BREAKER, CIRCUIT 200 AMP.....1pc
- 6) P/N 16923 – TERMINAL, LUG #1/0 0.25 DIA.....2pc
- 7) P/N 30766 – SWITCH, DISCONNECT.....4pc
- 8) P/N 17010 – BRACKET, SWITCH MNT. ELE. CRN.....1pc
- 9) P/N 17062 – TERMINAL LUG #1/0 GA 0.37 DIA... ..1pc
- 10) P/N 31837 – WIRE, BATTERY 1/0 GA 0.31DIA.....2pc
- 11) P/N 15737 – TERMINAL, RING 10-12 GA #8.....1pc
- 12) P/N 30728 – WIRE, GROUND #4 X 36" LONG.....1pc
- 13) P/N MH\*01143 – CAP, BREATHER ¾ NPT-MONARCH.....1pc
- 14) P/N 22434 – INSTALLATION INTS. 5000 & 6036.....1pc
- 15) P/N 18600 – PLATE, CRANE-TRUCK STABILITY.....1pc
- 16) P/N 25013 – DECAL, LOAD CAPACITY 25,000.....1pc
- 17) P/N 23144—LEVEL AND TAPE ASSEMBLY.....1pc



F2030-A  
05/13/15

HOUSTON, TEXAS  
FAX: (800) 824-5559 (USA & Canada)  
FAX: (713) 688-6324  
PHONE: (713) 688-5533  
[www.liftmoore.com](http://www.liftmoore.com)

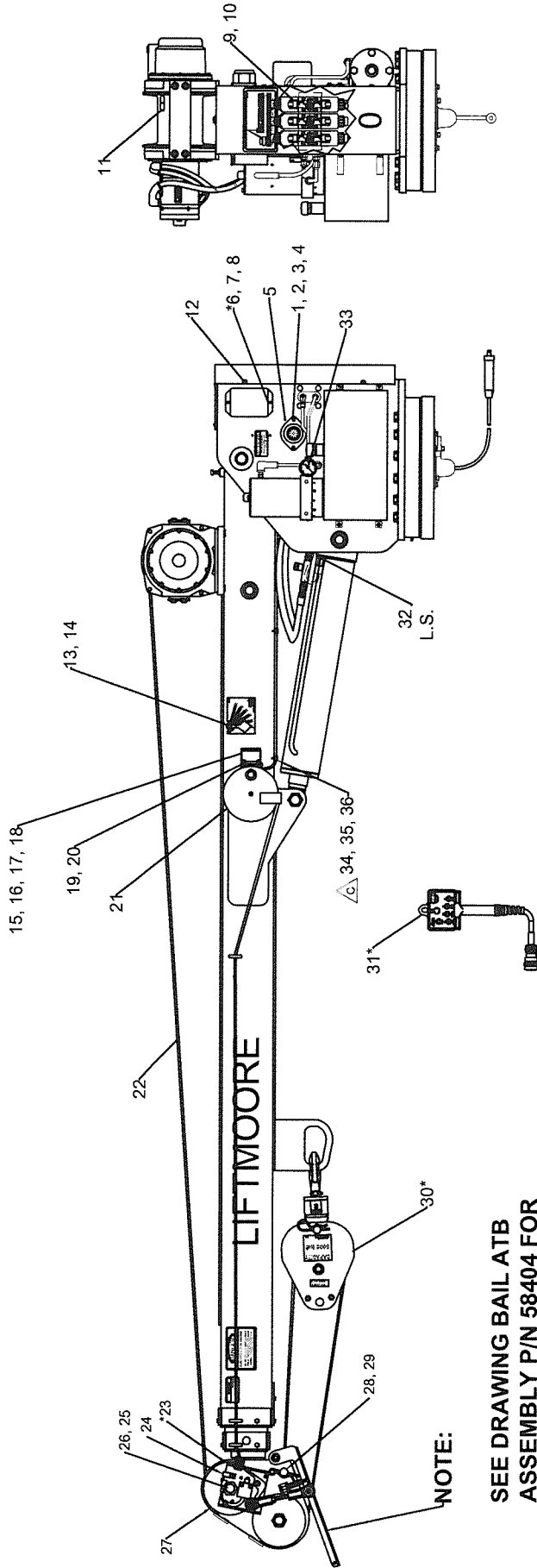

**NOTE:**  
SEE DRAWING BAIL ATB  
ASSEMBLY P/N 58404 FOR  
ASSEMBLY REFERENCE  
& PART NUMBERS

ITEMS WITH \* HAVE DETAIL DRAWINGS

#	PN	DESCRIPTION	QTY	#	PN	DESCRIPTION	QTY	#	PN	DESCRIPTION	QTY
1	23770	EWB, DTCH ELEC 60X/50X KMFM	1	15	70012	BRACKET, CORD REEL	1	29	31948	CLIP, HAIRPIN 0.87 - 1.00	1
2	30809	SCREW, HHC 0.25-20 X 0.50 GR5	1	16	30833	NUT, HEX NYLOC 0.25-20 GR2	2	30	22529	BLOCK, TRAV ASSY 5.0K LBS/5.3D	1
3	30457	SCREW, HHC 0.25-20 X 0.75 GR5	1	17	31110	WASHER, FLAT 0.25 GR5 PLATED	2	31	23197	CONTROL, PENDANT E-STOP	1
4	30833	NUT, HEX NYLOC 0.25-20 GR2	1	18	30457	SCREW, HHC 0.25-20 X 0.75 GR5	2	32	20415	SWITCH, PRES ASSY 2050PSI/DTCH	1
5	33144	SCREW, MH HX 10-24 X 0.50	1	19	33410	SCREW, MH RD 10-24 X 3.00	1	33	23188	PRESSURE GAUGE, 0-3000 PSI	1
6	22214	BOARD, RELAY 3RD G X ATB-BD	1	20	33409	NUT, HEX NYLOC 10-24 GR2	1	34	24960	CLAMP, HOSE SUPPORT 0.25 ID	1
7	33376	SCREW, SOC HD 10-24 X 0.75 SS	2	21	20407	REEL, CORD 20 FT ASSY DTCH	1	35	30889	WASHER, LOCK 0.25 GR5 PLATED	3
8	33409	NUT, HEX NYLOC 10-24 GR2	2	22	30608	ROPE, WIRE 0.31 X 80' WTH&LP	1	36	26582	SCREW, SOC HD 0.25-20 X 0.37SS	3
9	24432	VALVE ASSY 4W/3P/12V/OC DTCH	3	23	25149	ATB BODY BAIL ASSY, DEUTS:CON	1	NOT SHOWN:			
10	30956	SCREW, SOC HD 10-24 X 2.00	12	24	32957	CLAMP, HOSE SUPPORT 0.62 ID	1	19847	CONNECTOR, DTCH 2P PLUG	1	
11	70041	NUT, HEX 0.44-20 GR2	1	25	34468	SCREW, SHEAVE SINGLE 1-8 3.25	2	19845	CONNECTOR, DTCH 2P RECPT	1	
12	32589	SCREW, HWHSMS 0.25-20 X 0.75	4	26	30838	NUT, HEX NYLOC 1.00-8 GRADE 5	2	19846	WEDGE, DEUTSCH 2P PLUG	1	
13	22394	PENDULUM, LOAD RADIUS DIA. HD	2	27	21108	SHEAVE ASSY 5.31PD X 0.31 ROPE	2	19848	WEDGE, DEUTSCH 2P RECPT	1	
14	31017	SCREW, SHOULDER 0.31-18 X 0.75	2	28	32668	PIN, CLEVIS 0.87 X 3.50 PLATED	1	33067	DECAL KIT 5000-20 & 5000X-20	1	

**LIFTMOORE**  
TRUCK CRANES

Houston TX  
(713)-688-5533  
www.liftmoore.com

DRWN BY: JE

DATE: 1/4/13

**CRANE ASSY 5000WX-20**

BAIL ATB, E-STOP, D VAL WITHORN

DRAWING NO.  
**25484-C**

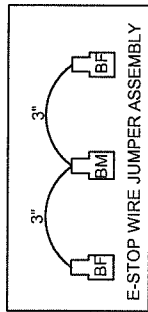
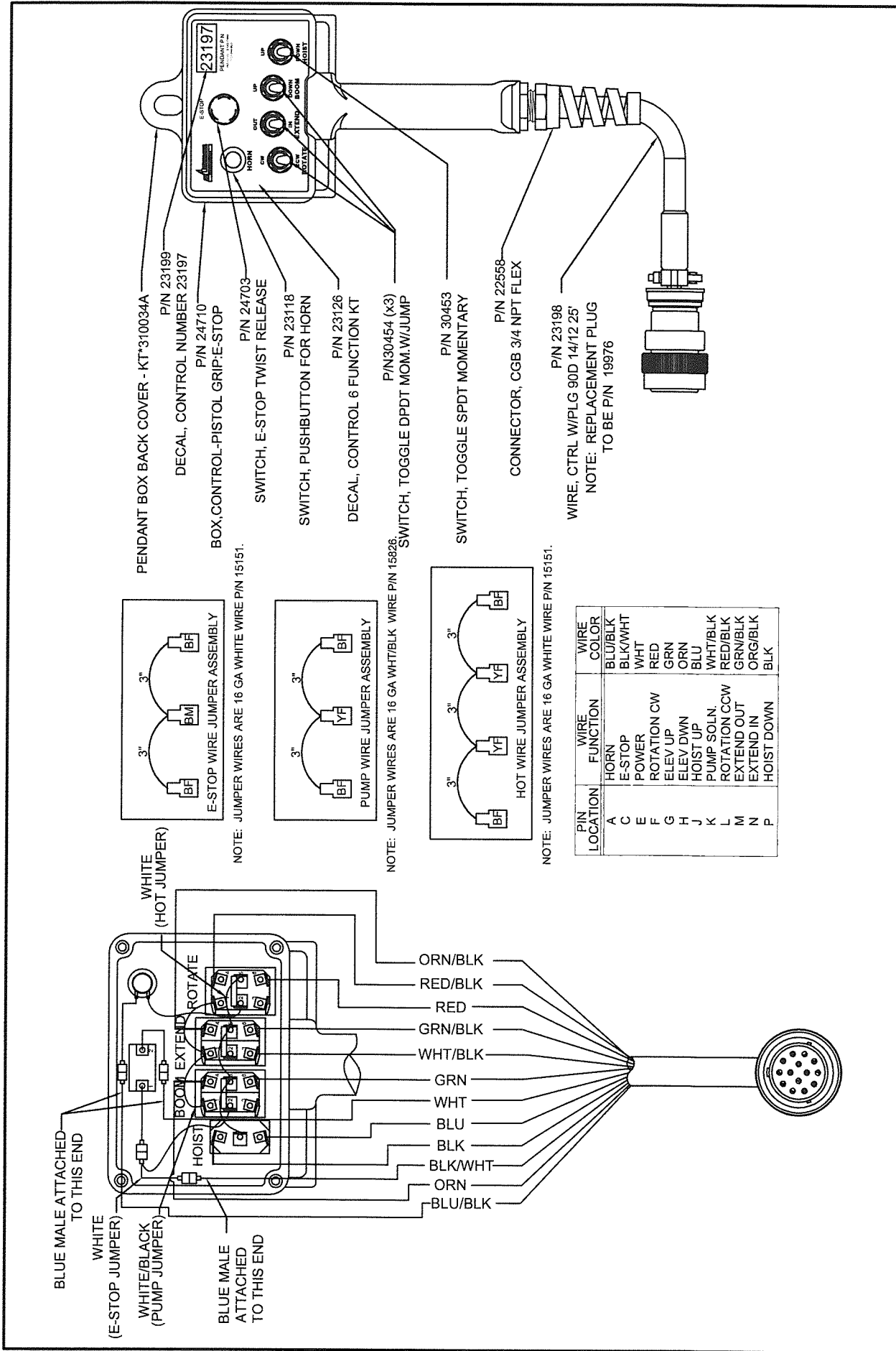

NOTE: JUMPER WIRES ARE 16 GA WHITE WIRE P/N 15151.

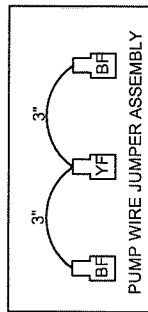

NOTE: JUMPER WIRES ARE 16 GA WHT/BLK WIRE P/N 15826.

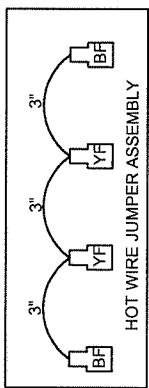

NOTE: JUMPER WIRES ARE 16 GA WHITE WIRE P/N 15151.

PIN LOCATION	WIRE FUNCTION	WIRE COLOR
A	HORN	BLU/BLK
C	E-STOP	BLK/WHT
E	POWER	WHT
F	ROTATION CW	RED
G	ELEV UP	GRN
H	ELEV DWN	ORN
J	HOIST UP	BLU
K	PUMP SOLN.	WHT/BLK
L	ROTATION CCW	RED/BLK
M	EXTEND OUT	GRN/BLK
N	EXTEND IN	ORG/BLK
P	HOIST DOWN	BLK

Houston TX  
(713)-688-5533  
www.liftmoore.com



DRWN BY: KSP  
DATE: 7/2/09

**CONTROL, PENDANT 5000/6036**  
WITH E-STOP AND HORN SWITCH

DRAWING NO.

**23197-B**

3RD GENERATION RELAY BOARD	
Pin No.	Description
1	Ground
2	No Connection
3	No Connection
4	Pressure Switch Input
5	ATB Switch Input
6	Winch Up Switch Input
7	Elevation Down Switch Input
8	Extension Out Switch Input
9	Extension Out Output
10	Elevation Down Output
11	Winch Up Output
12	Supply (9 To 30 VDC)

### ERROR CODE CHART

ERROR CODE COUNT	PROBABLE CAUSE
1	No Input To ATB Switch Input
2	No Input To Pressure Switch Input Or Overload Condition
3	Short Or Overload To Winch Up Output
4	Short Or Overload To Elevation Down Output
5	Short Or Overload To Extension Out Output
6	Trigger Input Out Of Range

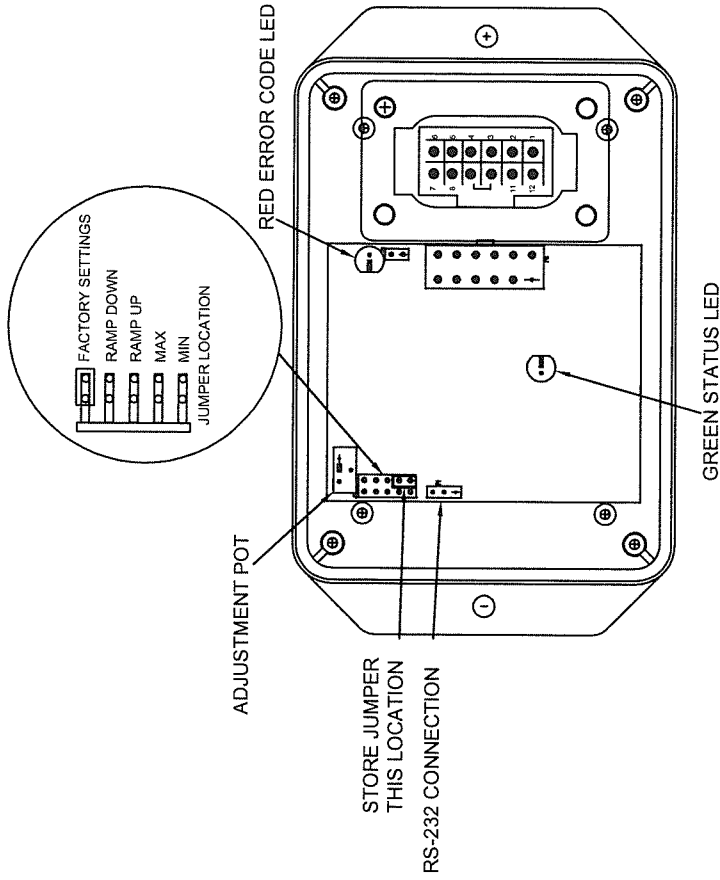

To Display an error code, the controller turns on and off the error code LED a certain number of times with a pause at the end. It repeats the code until the problem is resolved. The **Error Code Chart** is provided to assist the service personnel in troubleshooting the system.

	Houston TX (713)-688-5533 www.liftmoore.com	DRWN BY: JC DATE: 06/05/07	DRAWING NO. <b>22214-B</b>
	<b>BOARD, RELAY 3RD G X ATB-BD</b> REPROGRAM; ON/OFF		

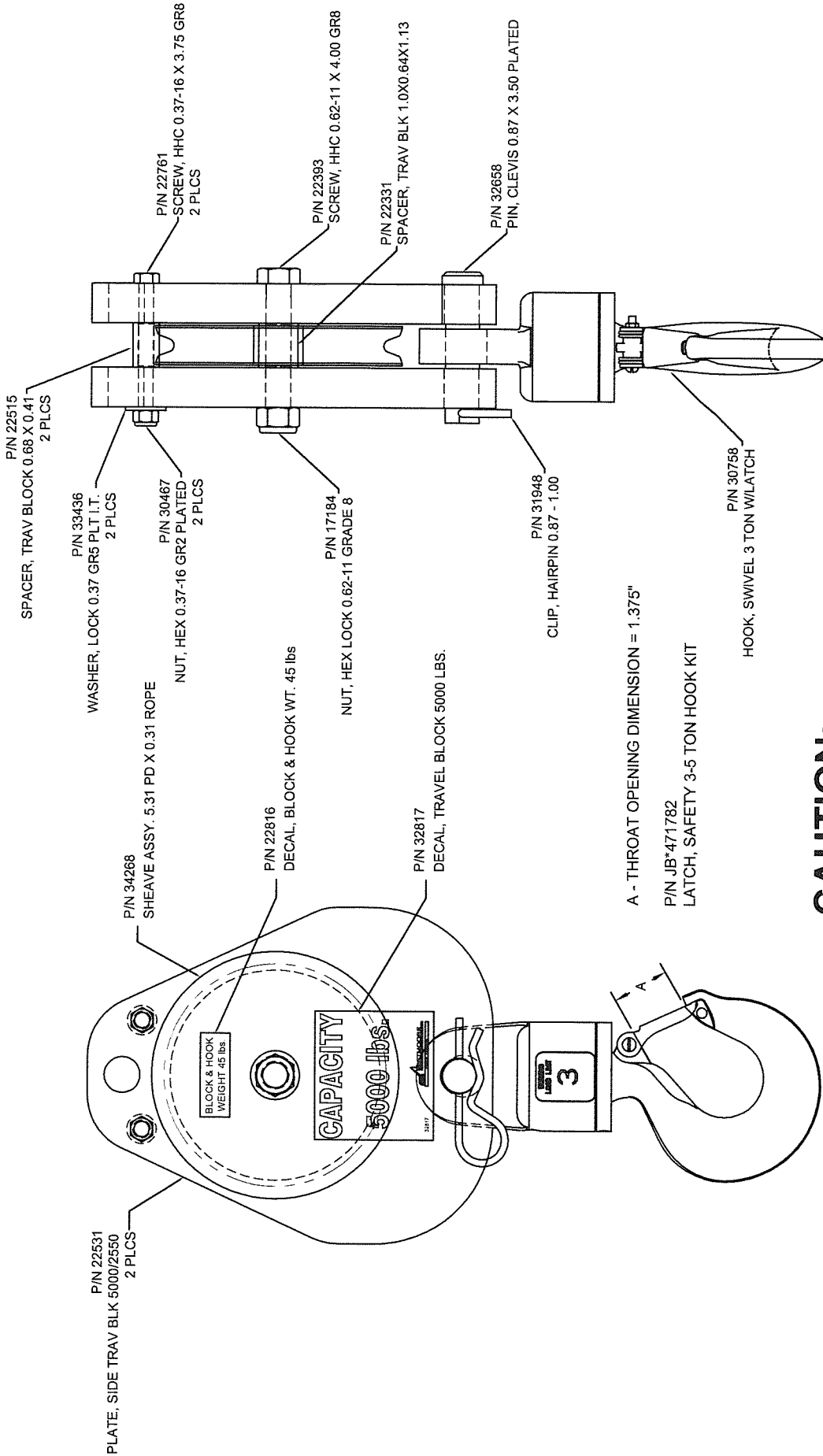

**CAUTION:**

NEVER USE A HOOK WHOSE THROAT OPENING HAS BEEN INCREASED, OR WHOSE TIP HAS BEEN BENT MORE THAN 10 DEGREES OUT OF PLANE FROM THE HOOK BODY, OR IS IN ANY WAY DISTORTED OR BENT.

Houston TX (713)-688-5533 www.liftmoore.com	DRWN BY: JC	<b>BLOCK, TRAV ASSY 5.0K LBS/5.3D</b> 5.31PD X 0.31 ROPE; 5K LBS	DRAWING NO. <b>22529-F</b>
	DATE: 6/23/08		



CROWN PLATE FOR REFERENCE ONLY

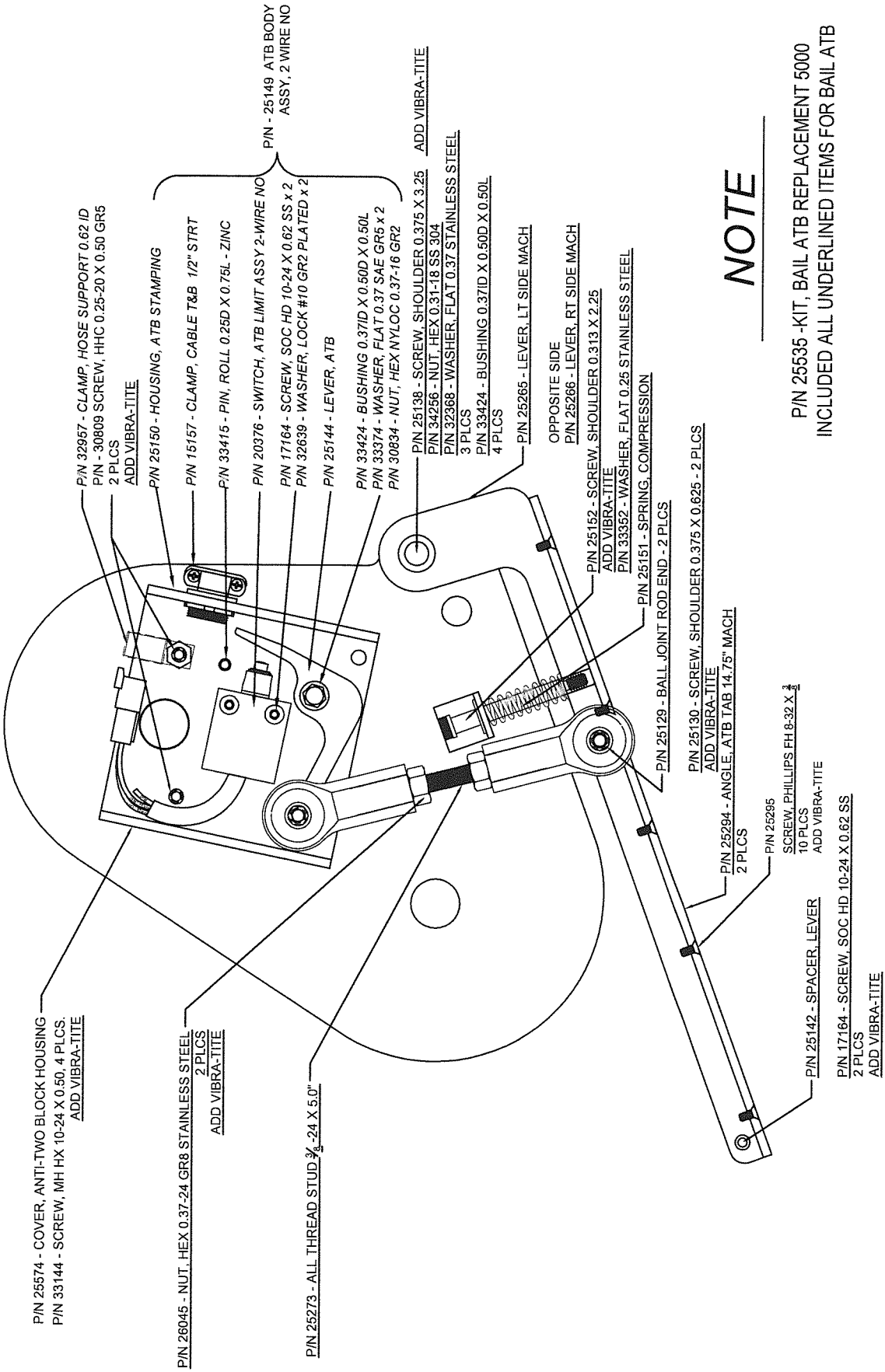

**NOTE**

PIN 25535 -KIT, BAIL ATB REPLACEMENT 5000  
 INCLUDED ALL UNDERLINED ITEMS FOR BAIL ATB

Houston TX (713)-688-5533 www.liftmoore.com	DRAWN BY: AA	ATB BAIL ASSY, DEUTSCH CONN TWO-WIRE NORMALLY OPEN 5000 / 2550 BAIL ATB LEFT SIDE	DRAWING NO. <b>58404-J</b>
	DATE: 10/15/12		





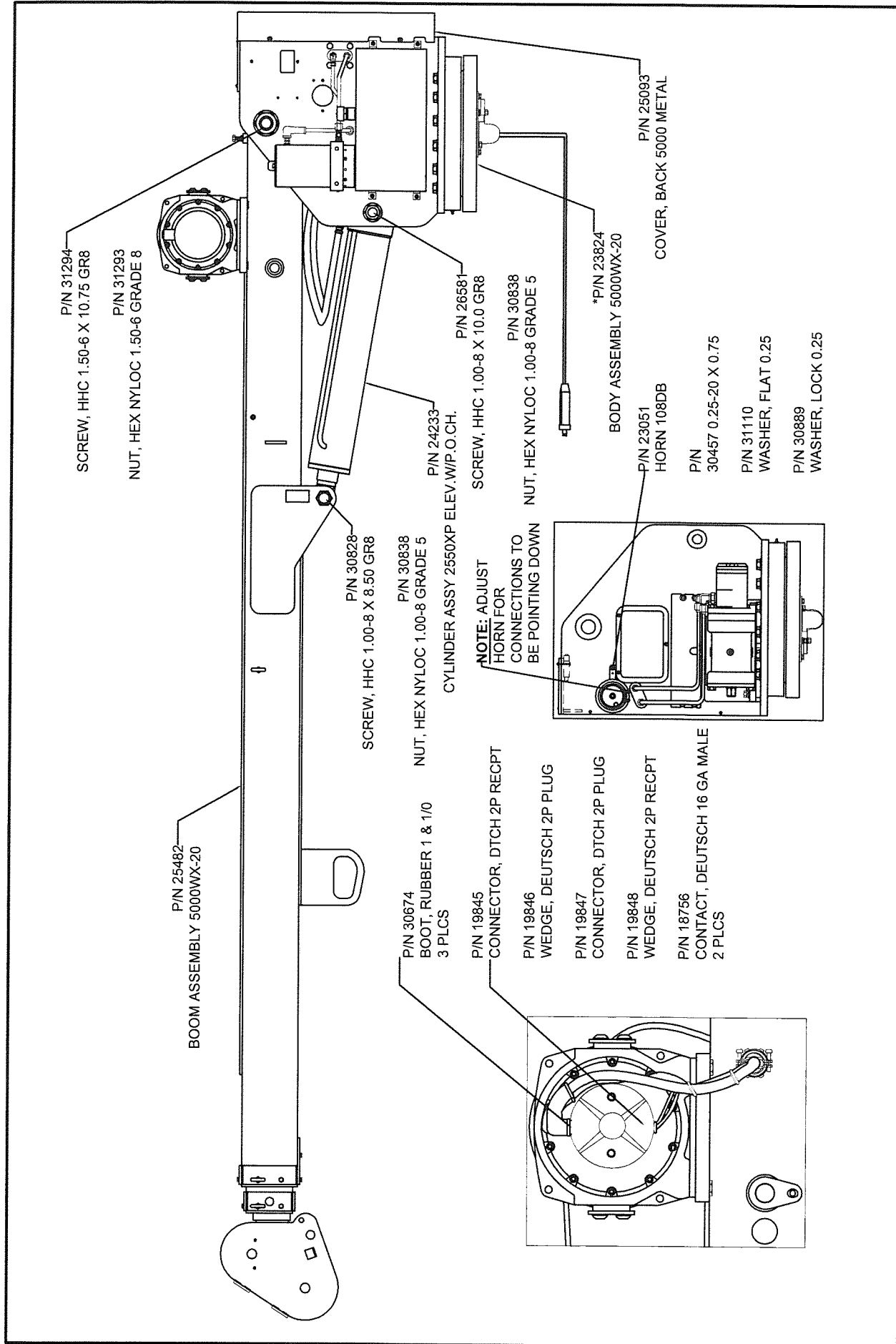

	Houston TX (713)-688-5533 www.liftmoore.com	DRWN BY: JE DATE: 1/4/13	DRAWING NO. <b>25483-B</b>
	<b>BOOM-BODY ASSY 5000WX-20 HORN</b> BAIL ATB; E-STOP; HORN		

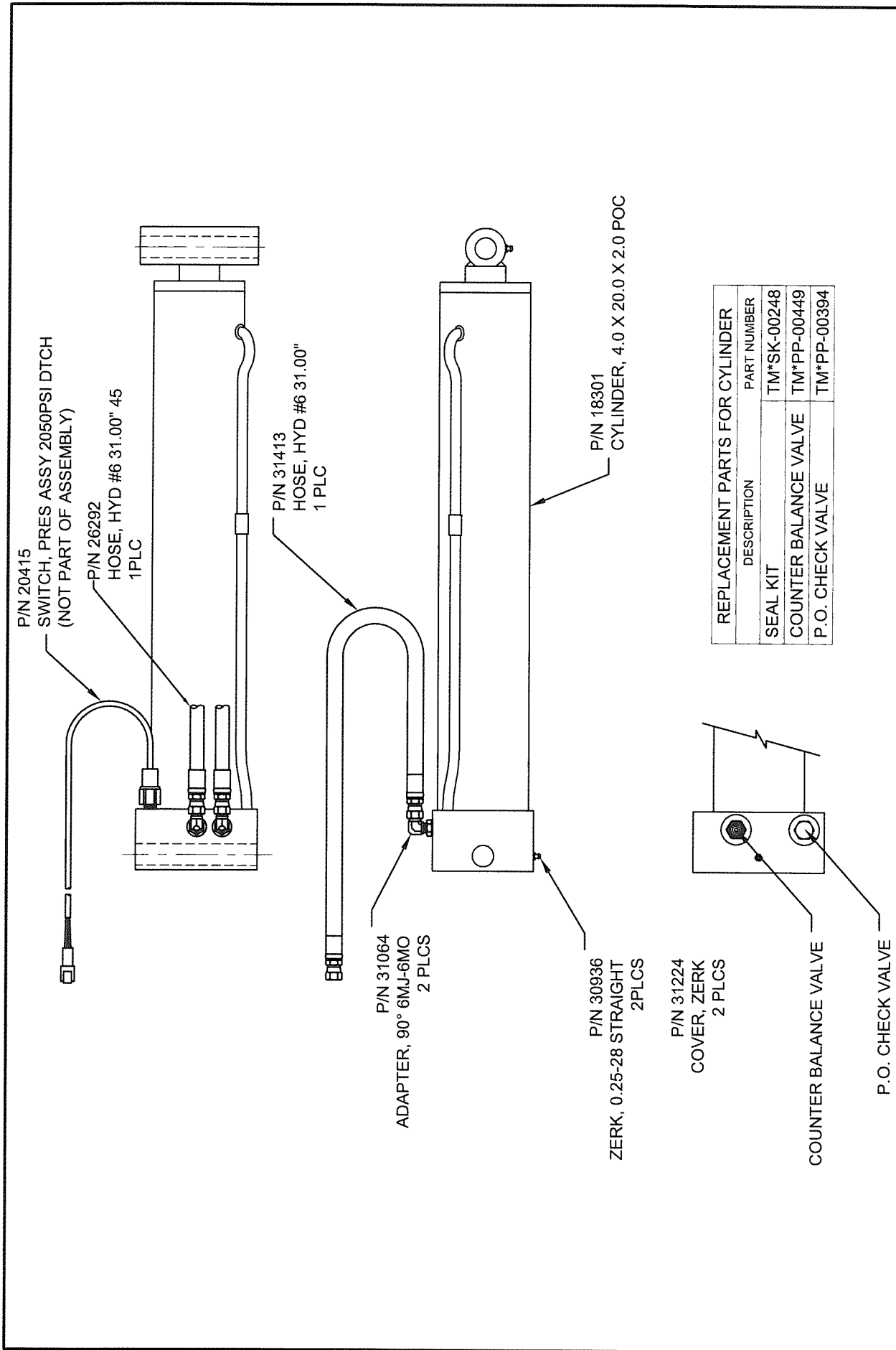

REPLACEMENT PARTS FOR CYLINDER	
DESCRIPTION	PART NUMBER
SEAL KIT	TM*SK-00248
COUNTER BALANCE VALVE	TM*PP-00449
P.O. CHECK VALVE	TM*PP-00394

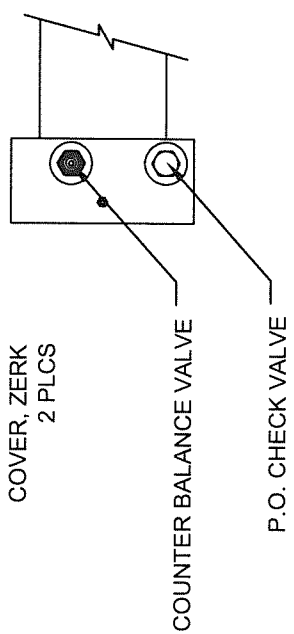

DRAWING NO.  
**24233-B**

**CYLINDER ASSY 5000X ELEV DTCH**  
W/ BEST METAL CYLINDER

DRWN BY: JE  
DATE: 12/10/10

Houston TX  
(713)-688-5533  
www.liftmoore.com





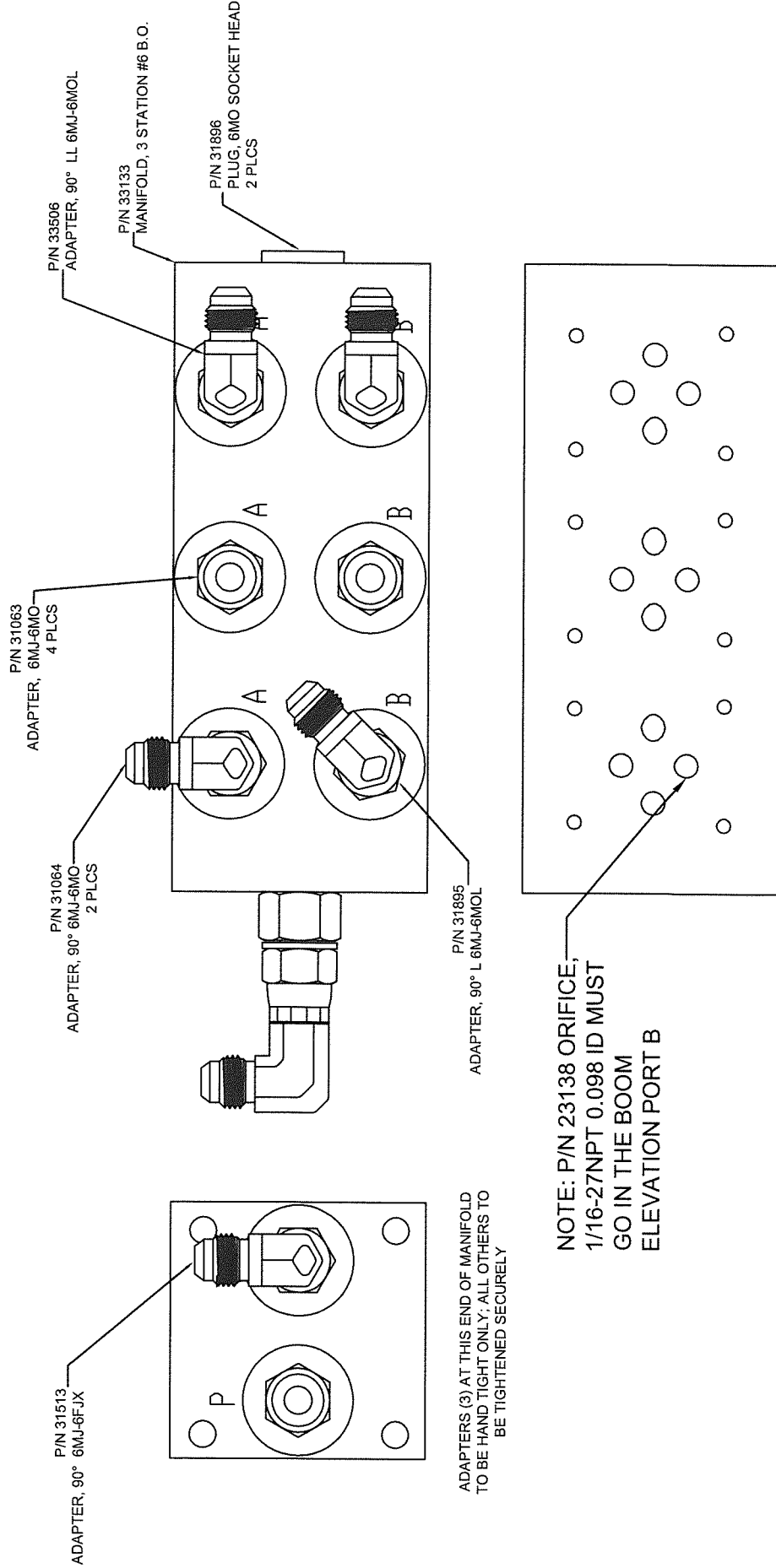

ADAPTERS (3) AT THIS END OF MANIFOLD TO BE HAND TIGHT ONLY; ALL OTHERS TO BE TIGHTENED SECURELY

NOTE: P/N 23138 ORIFICE, 1/16-27NPT 0.098 ID MUST GO IN THE BOOM ELEVATION PORT B

	Houston TX (713)-688-5533 www.liftmoore.com	DRWN BY: KSP DATE: 7/21/09	MANIFOLD ASSEMBLY 6036X #6 X #6 PORTS MANIFOLD	DRAWING NO. <b>22069-E</b>
--	---	-------------------------------	---	-------------------------------

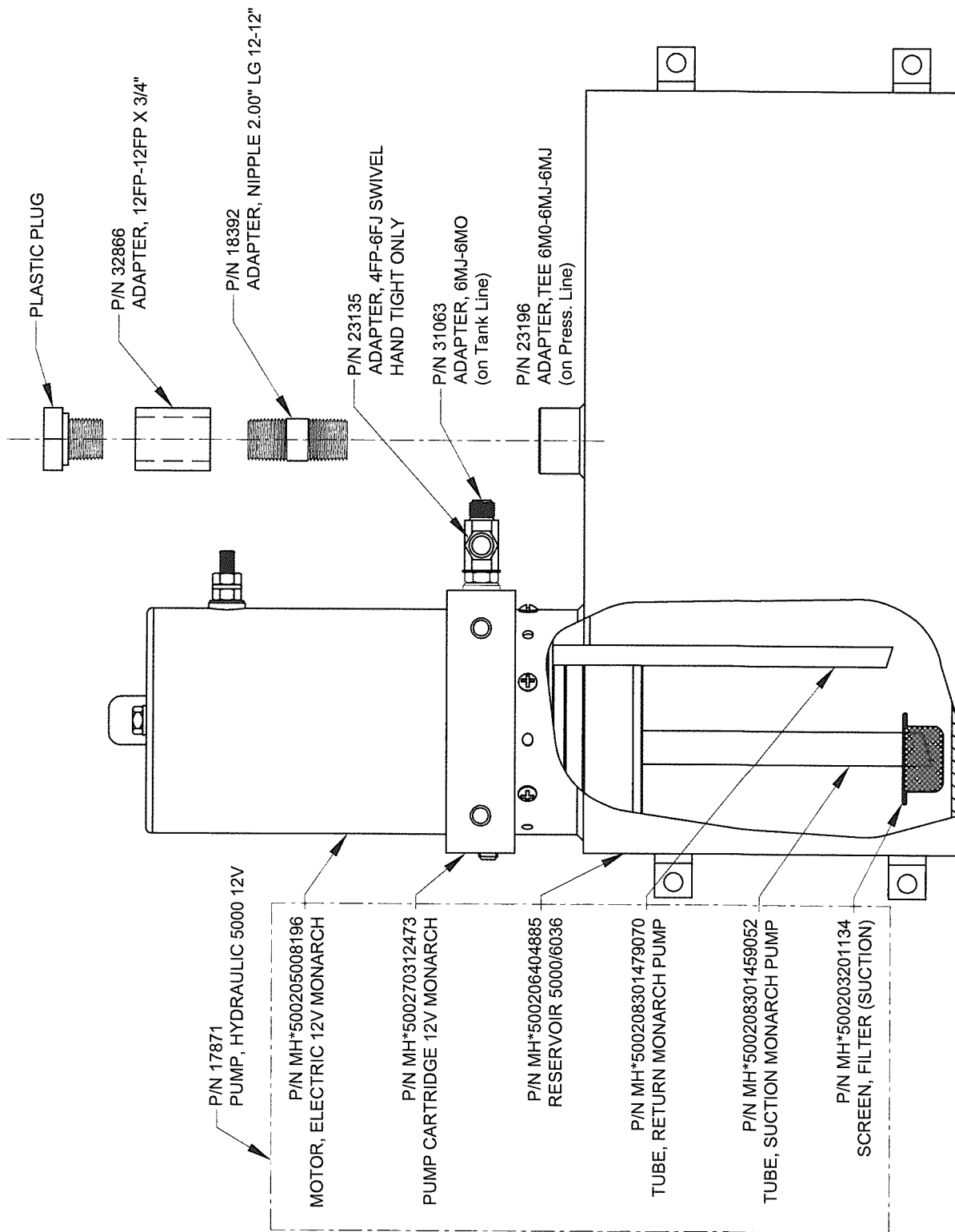

DRAWING NO. **23200-A**

**PUMP ASSEMBLY 5000/6036**  
MONARCH PUMP

DRWN BY: KSP  
DATE: 7/2/09

Houston TX  
(713)-688-5533  
www.liftmoore.com



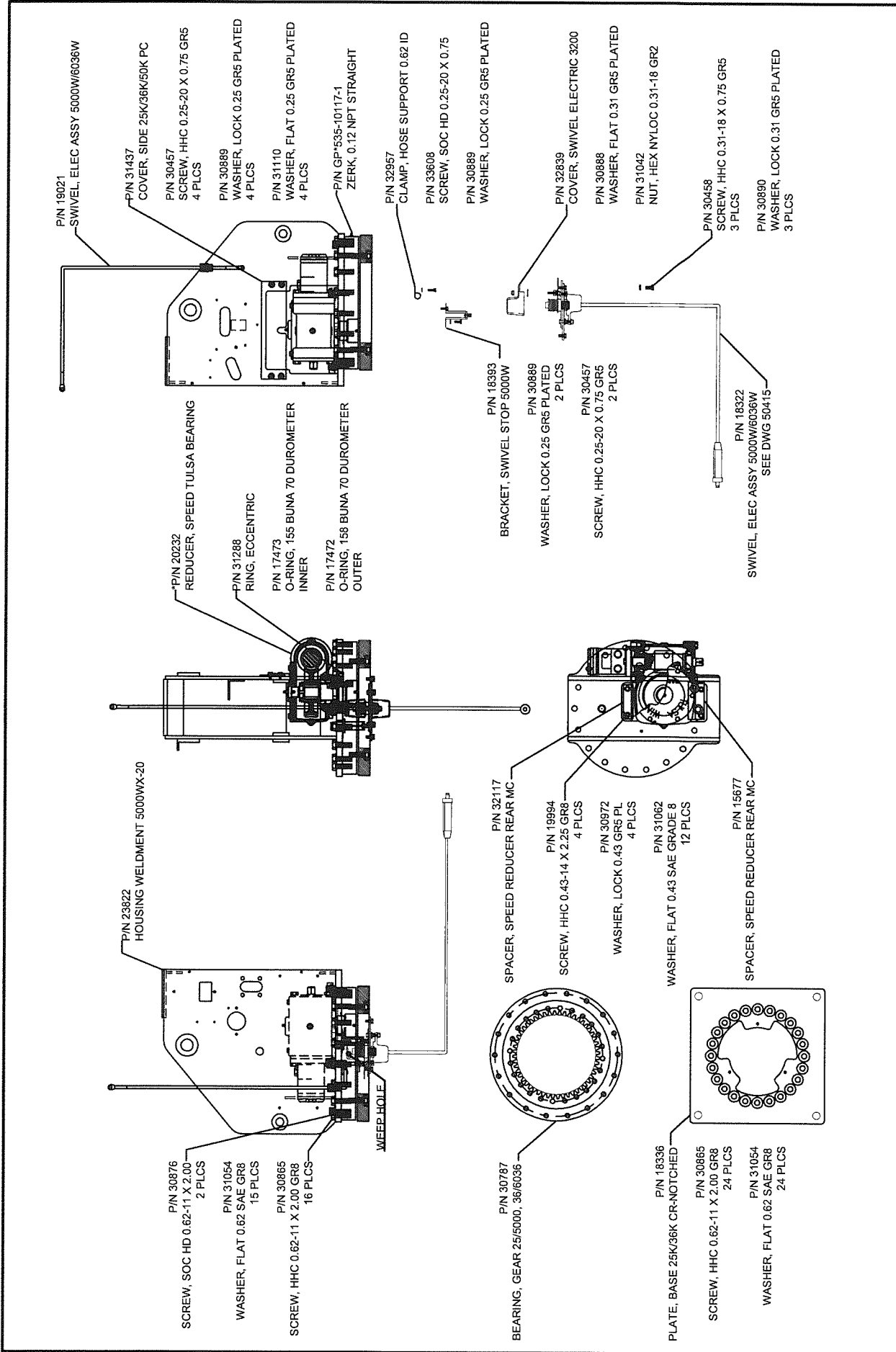

Houston TX  
 (713)-688-5533  
 www.liftmoore.com

DRWN BY: IS  
 DATE: 6/29/10

BASE-HOUSING ASSY 5000WX-20  
 L.S. ATB; E-STOP

DRAWING NO. 23823-B

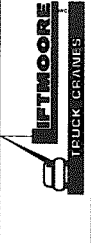

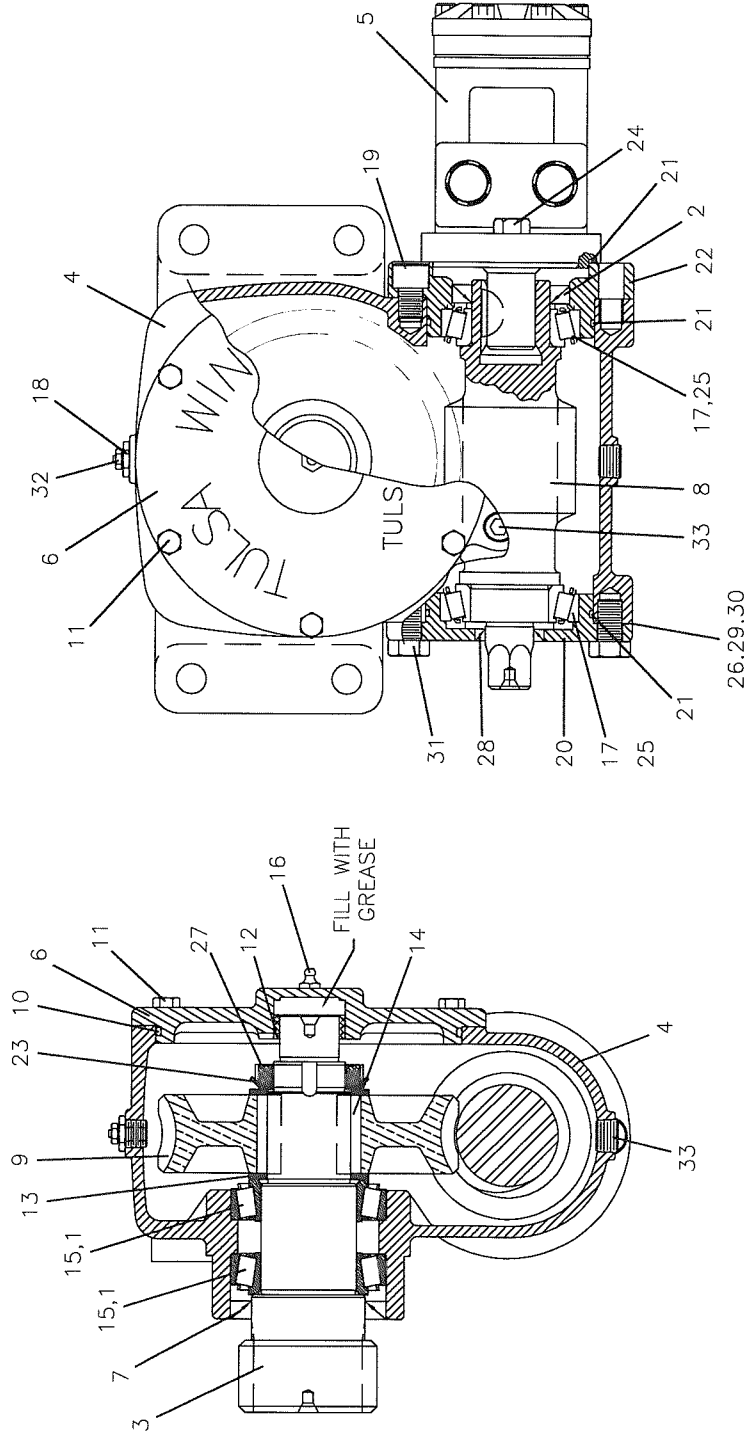

#	PN	DESCRIPTION	QTY	#	PN	DESCRIPTION	QTY	#	PN	DESCRIPTION	QTY
1	TW*41983	CUP, BEARING, HFG93	2	13	TW*40510	WASHER, THRUST	2	25	TW*996516	CUP, BEARING	2
2	TW*33155	SEAL, OIL	1	14	TW*40518	KEY	2	26	TW*42366	SHIM, G1600D	2
3	TW*43742	SHAFT, OUTPUT, PINION	1	15	TW*41982	CONE, BEARING, HFG9	2	27	TW*26528	LOCKNUT	1
4	TW*43492	HOUSING, 900D	1	16	TW*21128	FITTING, GREASE ZERK	1	28	TW*24180	SEAL, OIL	1
5	TW*42765	MOTOR, HYDRAULIC	1	17	TW*996515	CONE, BEARING	2	29	TW*42367	SHIM, G1600D	2
6	TW*42000	COVER, HFG938D	1	18	TW*12208	BUSHING, PIPE	1	30	TW*42368	SHIM, G1600D	2
7	TW*41979	SEAL, OIL, HFG938D	1	19	TW*43537	CAPSCREW, SOCKET HEAD	2	31	TW*24943	CAPSCREW	4
8	TW*43745	WORM, SR, HFG945D	1	20	TW*43467	CAP, END, 900D	1	32	TW*20375	BREATHER	1
9	TW*42578	GEAR, SR, HFG945D	1	21	TW*32566	O-RING	3	33	TW*32220	PLUG, PIPE	2
10	TW*40547	O-RING	6	22	TW*43465	CAP, END, MOTOR	1	34	TW*709169	PAINT, WHITE	1
11	TW*40407	CAPSCREW	1	23	TW*41299	LOCKWASHER	1				
12	TW*17451	BUSHING, HFG900D	1	24	TW*10381	CAPSCREW	2				

Houston TX  
 (713)-688-5533  
 www.liftmoore.com



REDUCER, SPEED TULSA BEARING

DRAWING NO.

20232-0

DRWN BY: SJN

DATE: 9/5/02

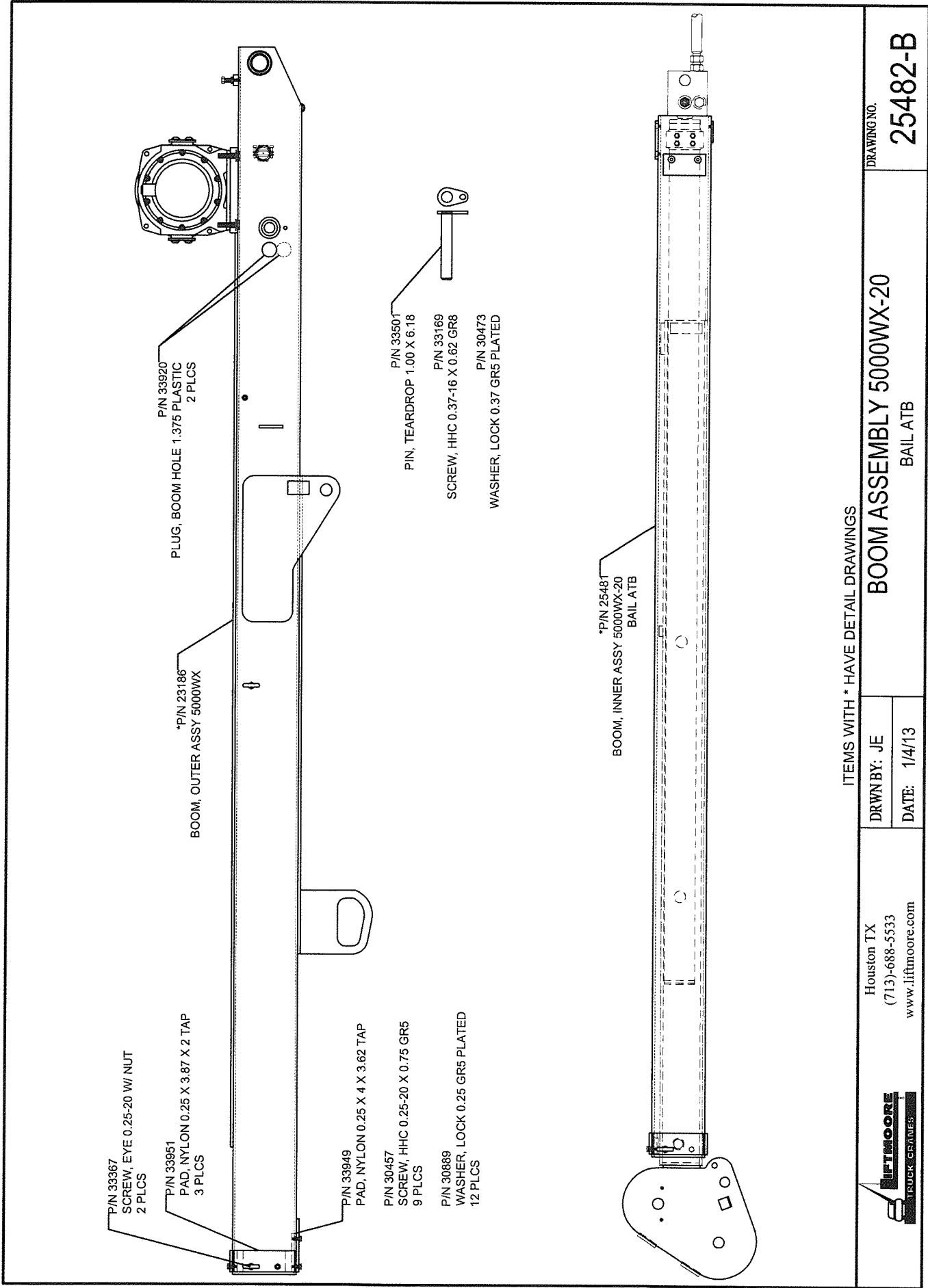

ITEMS WITH \* HAVE DETAIL DRAWINGS

DRWN BY: JE  
DATE: 1/4/13

Houston TX  
(713)-688-5533  
www.liftmoore.com



BOOM ASSEMBLY 5000WX-20  
BAIL ATB

DRAWING NO.

25482-B



- P/N 31949  
PLATE, LIMIT SWITCH ADJ. MACH
- P/N 30812  
SCREW, HHC 0.37-16 X 1.25 GR8
- P/N 30467  
NUT, HEX 0.37-16 GR2 PLATED
- P/N 30457  
SCREW, HHC 0.25-20 X 0.75 GR5  
2 PLCS
- P/N 30889  
WASHER, LOCK 0.25 GR5 PLATED  
2 PLCS

FOR UPLIMIT SWITCH

- P/N 30892  
CLAMP, CABLE T&B 1" STRT

P/N 23185  
BOOM, OUTER 5000WX WELD

- P/N 18884  
WINCH, ELEC 12VDC 5000W/6036W  
SEE DWG 50459 FOR WINCH PARTS

- P/N 33481  
BUSHING, 1.50 X 1.75 X 1.50L N  
2 PLCS

- P/N 70027  
SCREW, HHC M12 X 1.75-45MM GR8  
4 PLCS
- P/N 19323  
WASHER, FLAT 0.50 SAE GR8  
4 PLCS

	Houston TX (713)-688-5533 www.liftmoore.com	DRWN BY: JC DATE: 06/17/09	DRAWING NO. <b>23186-B</b>
<b>BOOM, OUTER ASSY 5000WX</b> DC 3000 WINCH; ATB LEFT SIDE			

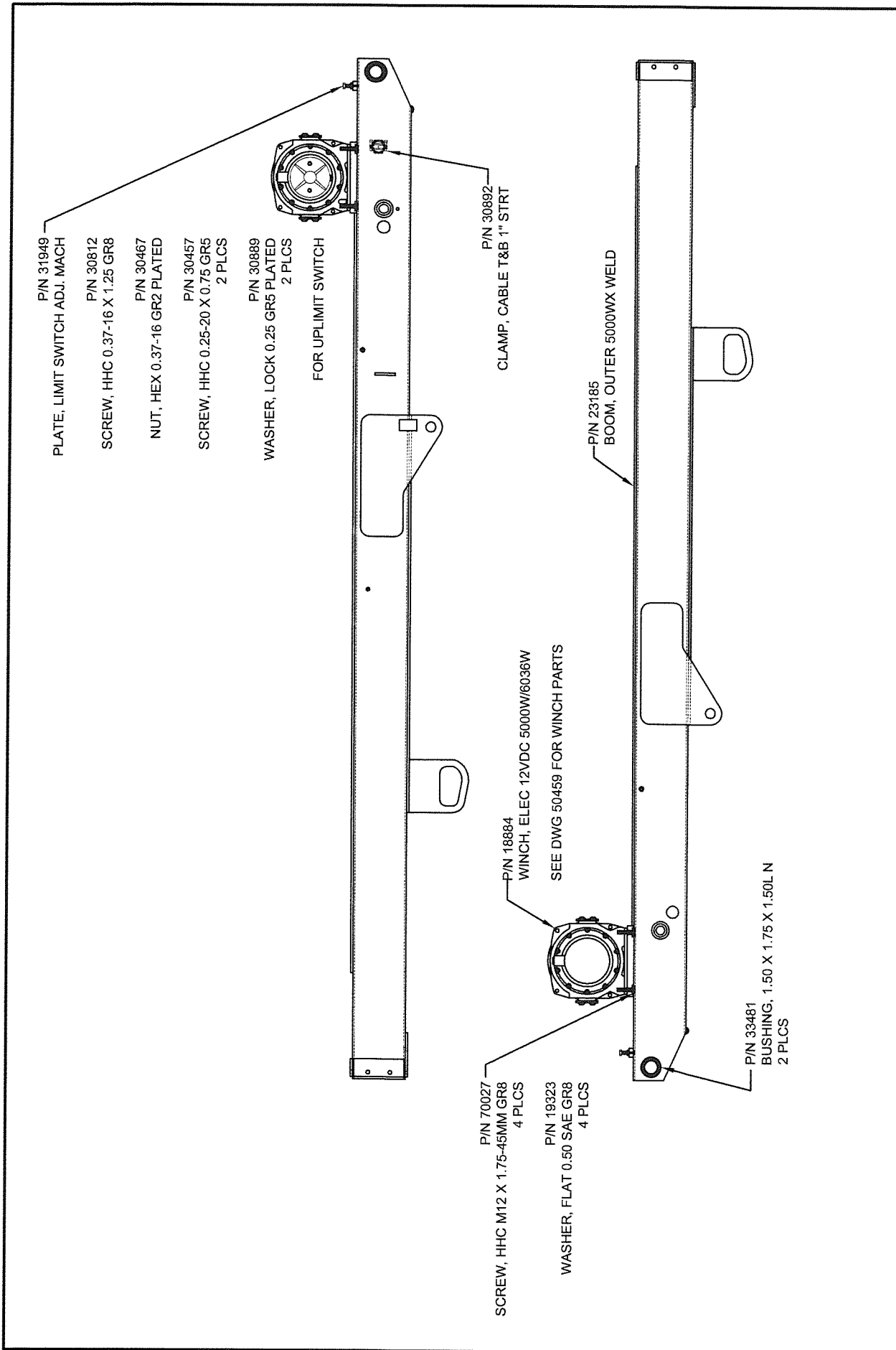

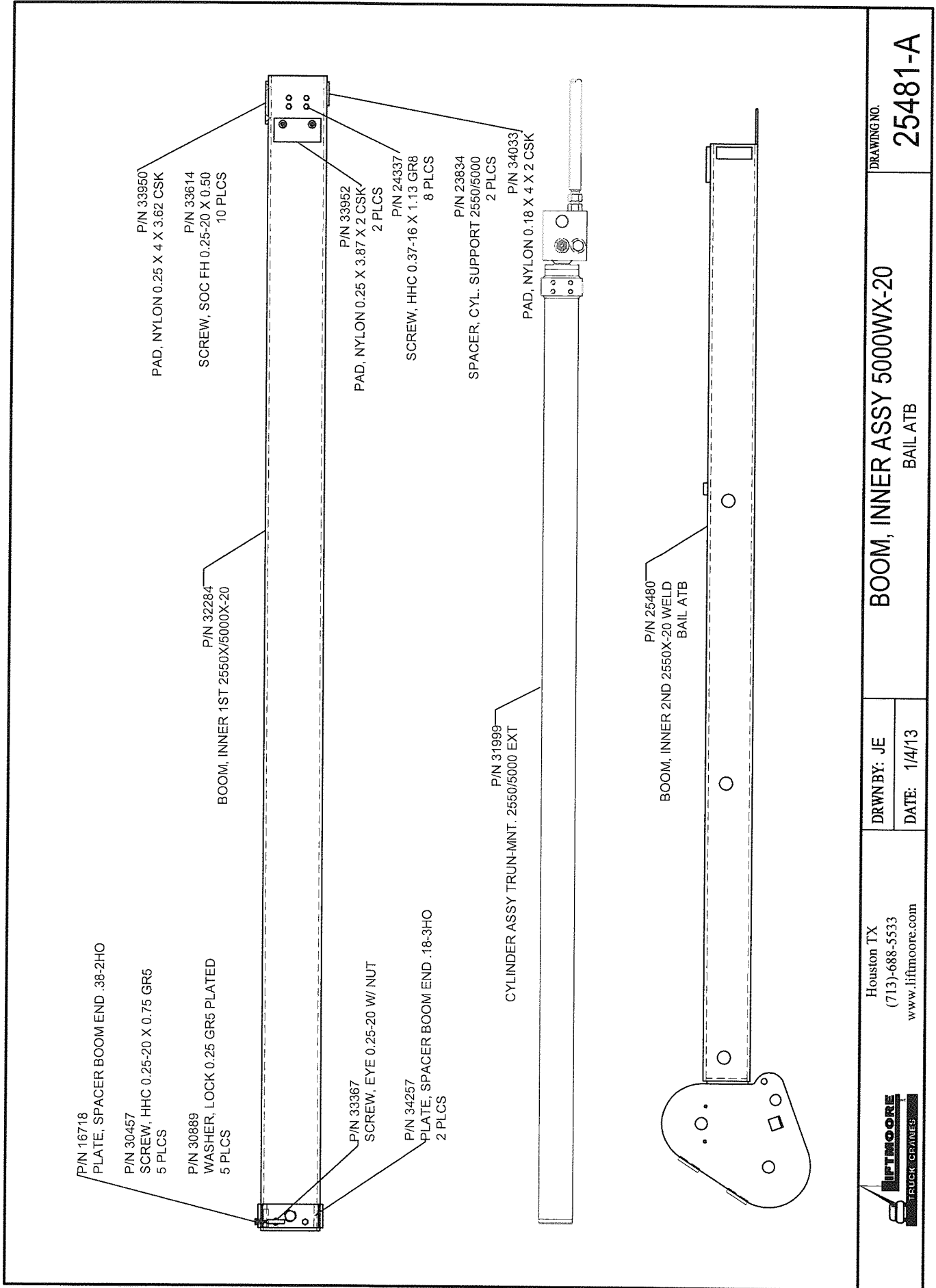

Houston TX  
 (713)-688-5533  
 www.liftmoore.com

DRWN BY: JE  
 DATE: 1/4/13

BOOM, INNER ASSY 5000WX-20  
 BAIL ATB

DRAWING NO.

25481-A



**WINCH DC3000 -12VDC P/N 18884**

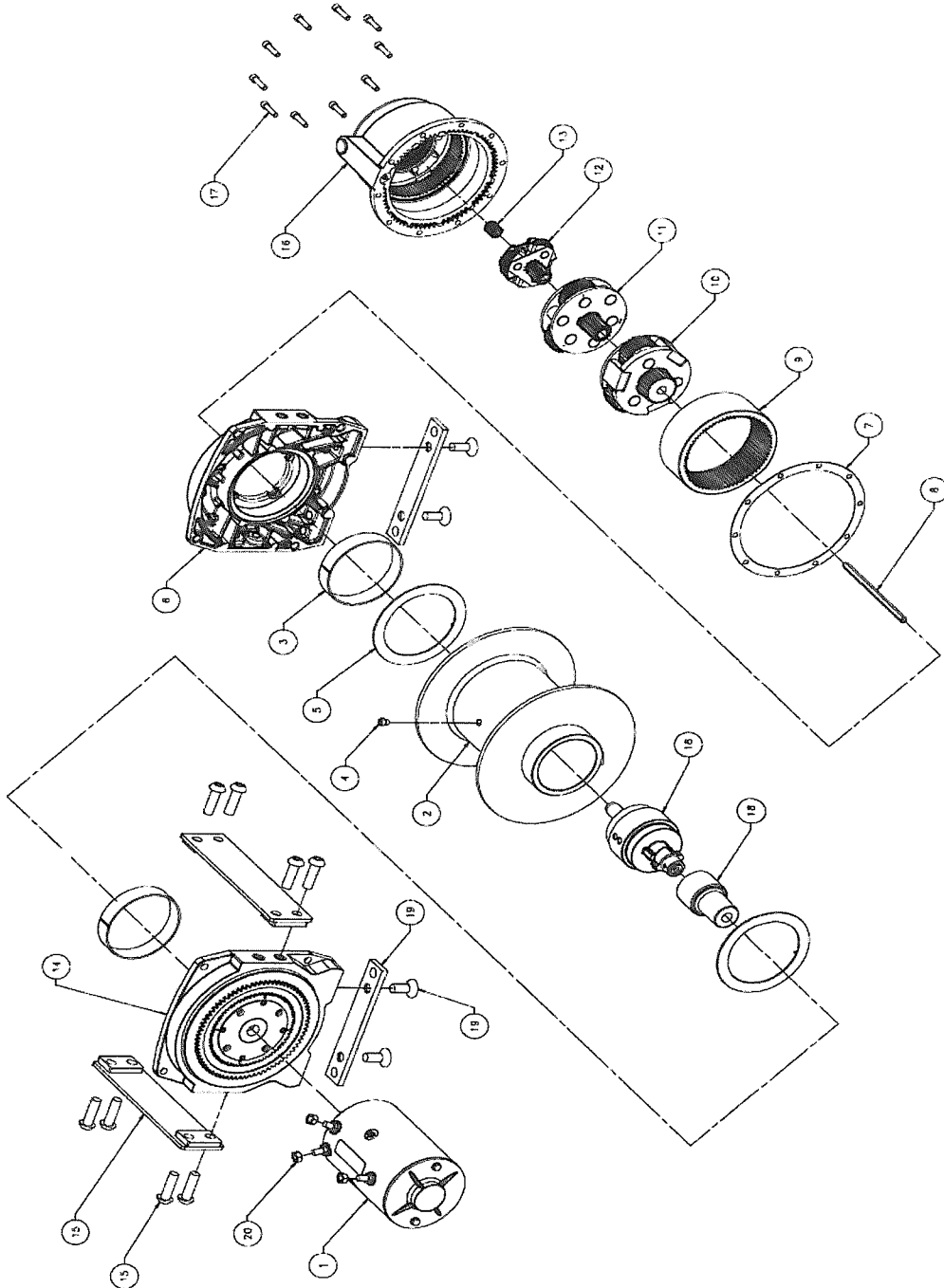

18884-D  
05/12/15

HOUSTON, TEXAS  
FAX: (800) 824-5559 (USA & Canada)  
FAX: (713) 688-6324  
PHONE: (713) 688-5533  
[www.liftmoore.com](http://www.liftmoore.com)

## SERVICE PARTS LIST: DC3000 HOIST-12V P/N 18884

ITEM REFERENCE	ITEM / KIT No.
1. (MTO)S/P ELECTRIC MOTOR, 12VDC	WI*31681
2. DRUM SUBASSY, DC3000	WI*39924
3. BUSHING DRUM NYLATRON	WI*30274
4. (KB) SET SCREW, DOG POINT, M10	WI*36974
5. WASHER, THRUST, NYLATRON, CIM	WI*30277
6. (MTO)S/P DRUM SUPPORT ASSY	WI*31675
7. GASKET, RING GEAR	WI*14964
8. (HEX) SHAFT, DRIVE, 5/16 X 6.0	WI*37188
9. RING GEAR, (PH) STAGE 3, FS WN	WI*18336
10. CARRIER ASSY, 3RD STG, 30T PLT	WI*33413
11. CARRIER ASSY, 2ND STG, 31T PLT	WI*33417
12. CARRIER (PH) ASSY, STG 1,24P X 12	WI*27837
13. GEAR, SUN, 12 TEETH, FS WN	WI*19574
14. (MTO)S/P DRUM SUPPORT ASSY	WI*31680
15. SVC KIT PLATE, TIE BAR	WI*85581
16. S/P GEAR HOUSING ASSY W/CLUTCH	WI*62797
17. CAP SCREW SOC HD 1/4 X 1	WI*1448
18. (MTO) S/P BREAK ASSY, 3000#	WI*37467
19. SVC KIT PLATE, SPACER	WI*85582
20. NUT,HEX,M8 X 1.25,GR8.8,STEEL	WI*13455



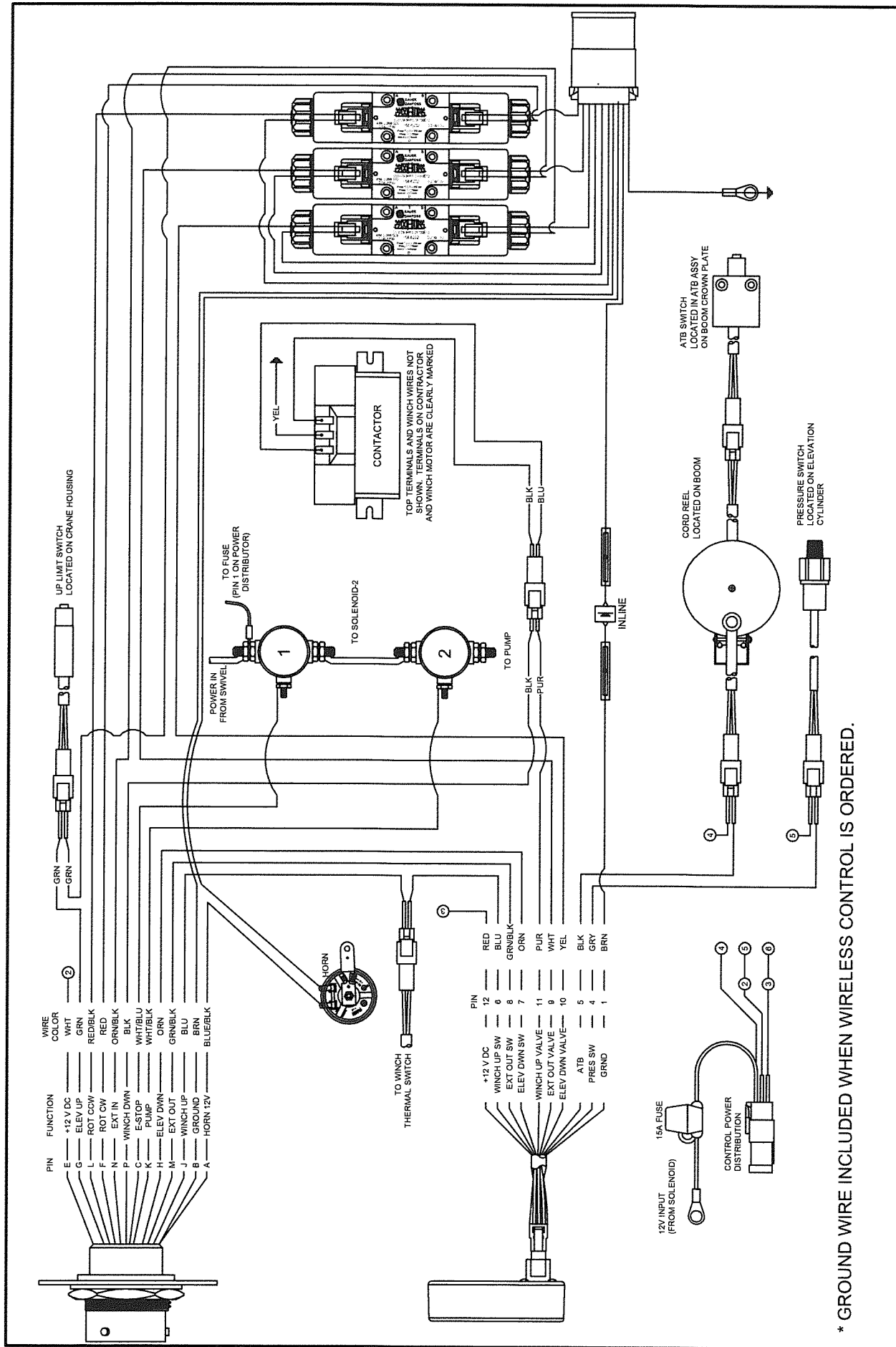

DRAWING NO.  
**50810-A**

**SCHEM, ELEC DTCH 5000/6036 HORN**  
E-STOP, SAUER DANFOSS

DRWN BY: JE  
DATE: 10/5/11

Houston TX  
(713)-688-5533  
www.liftmoore.com

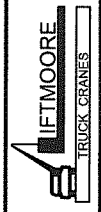

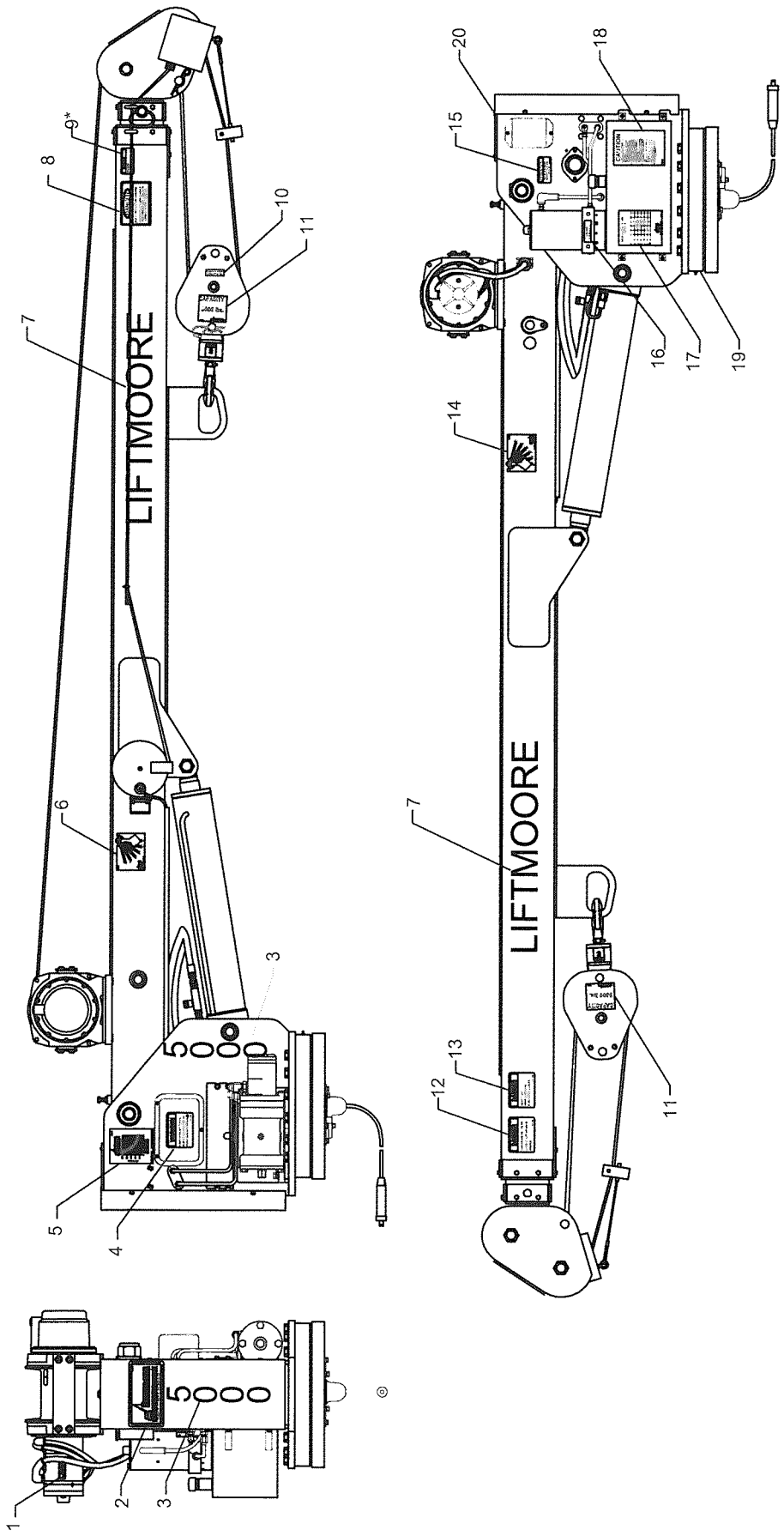

\*APPLIES TO 20FT CRANES

#	PN	DESCRIPTION	QTY	#	PN	DESCRIPTION	QTY	#	PN	DESCRIPTION	QTY
1	32608	DECAL, MOTOR MAGNETS DAMAGE	1	8	15618	DECAL, DANGER ELECTRIC INJURY	1	15	15577	DECAL, ATTENTION BATTERY	1
2	15581	DECAL, LOGO LARGE	1	9	15612	DECAL, CAUTION PIN MUST BE IN	1	16	16103	DECAL, USE 46AW HYD. OIL	1
3	15761	DECAL, 5000	2	10	22816	DECAL, BLOCK & HOOK WT. 45 lbs	1	17	22379	DECAL, LOAD CAPACITY 25K-10-20	1
4	15615	DECAL, WARNING TRAVELING BLOCK	1	11	32817	DECAL, TRAVEL BLOCK 5000 LBS.	2	18	16102	DECAL, CAUTION READ MANUAL	1
5	19020	PLATE, SERIAL 5000W-2-PRT LINE	1	12	32085	DECAL, LIFTING PERSONNEL	1	19	19756	DECAL, ATTENTION GREASE GEAR	1
6	22376	DECAL, ANGLE PENDULUM RIGHT	1	13	15579	DECAL, DANGER CABLES	1	20	23336	PLATE, SERIAL NO. BLANK	1
7	15580	DECAL, LIFTMOORE - 3.00"	2	14	22375	DECAL, ANGLE PENDULUM LEFT	1				

Houston TX  
(713)-688-5533  
www.liftmoore.com

**DECAL DIAGRAM FOR THE**  
5000W & WX

DRAWING NO.  
**58298-C**

DRWN BY: JC

DATE: 11/25/09

## **LIFTMOORE LIMITED WARRANTY**

### Parts and Structural

Liftmoore, Inc. warrants each LIFTMOORE crane to be free from defects in materials and workmanship for twelve (12) months from the date of delivery to the original customer. Under the terms of this warranty the crane structural components manufactured by LIFTMOORE, Inc. are warranted for thirty-six (36) months from the date of delivery to the original customer. LIFTMOORE, Inc. will repair or replace, as its sole discretion, any equipment or part that is returned f.o.b. to LIFTMOORE, Inc.'s plant at 7810 Pinemont Drive, Houston, Texas 77040, or to one of its authorized dealers, and is found by LIFTMOORE, Inc. or its authorized dealer to have been defective at the time of original delivery.

The foregoing warranty is the exclusive warranty made by LIFTMOORE, Inc. with respect to its cranes and is in lieu of all other warranties. ANY AND ALL OTHER WARRANTIES, EXPRESS OR IMPLIED, INCLUDING ANY WARRANTY OF MERCHANTABILITY OR FITNESS OF ANY CRANE FOR A PARTICULAR PURPOSE OR OPERATION, ARE HERBY EXPRESSLY DISCLAIMED.

The foregoing warranty applies only to LIFTMOORE cranes under normal use and service and does not apply in the event of damage caused by repair or alteration or damage during shipment, accident, negligence, overloading, or misuse, including operator's failure to follow any of the instructions issued with the crane.

This warranty is limited to the original purchaser and is not assignable. In order to submit a claim, the original purchaser must provide a copy of the original invoice for the crane in question within twelve (12) months following the delivery date and within 30 days from the date of repair.

The warranty applies only when the LIFTMOORE crane is used for commercial purposes and does not cover any purchase for use for personal, family or household purposes.

**LIMITATION OF LIABILITY:** LIFTMOORE, Inc.'s liability for any losses or damages resulting from any cause whatsoever, including LIFTMOORE, Inc.'s NEGLIGENCE or from a defective crane irrespective of whether such defects are discoverable or latent, shall in no event exceed the purchase price of the crane to which losses or damages are claimed, or at the election of LIFTMOORE, Inc., the repair or replacement of the defective crane.

In no event shall LIFTMOORE, Inc. be liable for any special, incidental, or consequential damages, including commercial losses or costs of any kind sustained by purchaser or any other person or for any damages for which purchaser may be liable to other persons by reason of any defect in any LIFTMOORE crane or any part thereof.

LIFTMOORE, Inc. reserves the right to make changes in design or construction of its cranes at any time without obligating itself to make such changes on cranes previously manufactured.

No agent, employee, or representative of LIFTMOORE, Inc. has authority to amend or modify the foregoing warranty or to bind LIFTMOORE, Inc. by any other warranty, guaranty, or assumption of liability.

In the event any provision of this warranty is for any reason held ineffective, the remaining provisions shall remain in full force and effect.

Some states do not allow limitations on how long an implied warranty lasts or the exclusion or limitation of incidental or consequential damages, so the above limitations and exclusions may not apply to you. This warranty gives you specific legal rights, and you may also have other legal rights that vary from state to state.

