

TABLE OF CONTENTS
 USERS MANUAL 25188
 MANUAL, CRANE 2550XP-16 HALL EFFECT
 ATB LS;HORN; GAUGE

SECTION I GENERAL OPERATION, INSPECTION, AND MAINTENANCE

CRANE SAFETY RULES	F1122-B	1-1
INTRODUCTION	F1111-D	1-3
OPERATING RESTRICTIONS	F1112-F	1-4
OPERATING PRACTICES.....	F1112-F	1-4
INSPECTION AND MAINTENANCE.....	F1113-D	1-10
MONTHLY INSPECTION REPORT.....	F1123-B	1-12
ANNUAL INSPECTION REPORT	F1507-B	1-13

SECTION II CRANE SYSTEMS AND TROUBLESHOOTING

PROPORTIONAL CONTROL SYSTEM	F1126-A	2-1
SAFETY SYSTEM.....	F1769-0.....	2-2
PROPORTIONAL HYDRAULIC SYSTEM	F1668-0.....	2-3
BASIC TROUBLESHOOTING CHART.....	F1774-0.....	2-5
CONTROL TROUBLESHOOTING CHART.....	F1796-0.....	2-6
TROUBLESHOOTING, GENERAL.....	F1127-B	2-7
TROUBLESHOOTING PROPORTIONAL SYSTEM	F1447-A.....	2-10

SECTION III CRANE SPECIFICATIONS

LIFTING CAPACITIES	F1133-D	3-1
POWER FUNCTIONS AND SPEEDS	F1133-D	3-1
BOLT AND LUBRICATION SPECS.....	F1133-D.....	3-2
CRANE LUBRICATION POINTS	F1133-D	3-3

SECTION IV PARTS

BOX PARTS LIST.....	F1982-0.....	4-1
CRANE ASSEMBLY	DWG.25187-0	4-2
PENDANT CONTROL	DWG.24694-0	4-3
RELAY BOX ASSEMBLY.....	DWG.22569-A	4-4
TRAVEL BLOCK ASSEMBLY	DWG.22529-F.....	4-5
ANTI-TWO BLOCK ASSEMBLY	DWG.22908-A	4-6
BOOM-BODY ASSEMBLY	DWG.25115-0	4-7
ELEVATION CYLINDER ASSEMBLY	DWG.23543-A	4-8
BODY ASSEMBLY	DWG.25113-0	4-9
MANIFOLD ASSEMBLY.....	DWG.24994-0	4-10
MANIFOLD PRE-ASSEMBLY	DWG.24993-0	4-11
BASE-HOUSING ASSEMBLY	DWG.23224-D	4-12
ROTATION SPEED REDUCER.....	DWG.20232-0	4-13
ELECTRIC SWIVEL	DWG.20498-E.....	4-14



TABLE OF CONTENTS
USERS MANUAL 25188
MANUAL, CRANE 2550XP-16 HALL EFFECT
ATB LS;HORN; GAUGE

BOOM ASSEMBLY – 16 FT	DWG.23542-0	4-15
BOOM OUTER ASSEMBLY – 16 FT & 20 FT	DWG.22900-0	4-16
BOOM INNER ASSEMBLY – 16 FT	DWG.23541-0	4-17
WINCH.....	DWG.33528-0	4-18
WINCH BRAKE	DWG.50231-B	4-19
ELECTRICAL WIRING HARNESS	DWG.25125-0	4-20
ELECTRICAL SCHEMATIC.....	DWG.50826-0	4-21
HYDRAULIC SCHEMATIC	DWG.50801-A	4-22
DECAL DIAGRAM	DWG.58322-B	4-23
WARRANTY.....	F1442-A	



CRANE SAFETY RULES

CAUTION!

1. READ AND UNDERSTAND OPERATOR'S MANUAL.
2. INSPECT VEHICLE AND CRANE, INCLUDING ITS OPERATION BEFORE DAILY USE.
3. USE THIS EQUIPMENT ONLY ON SOLID LEVEL GROUND WITH OUTRIGGERS OR JACKSTANDS PROPERLY SET.
4. BEFORE OPERATING THE CRANE REFER TO MAXIMUM LOAD CHART ON CRANE FOR OPERATING LOAD LIMITS.
5. BE SURE LOAD BEING LIFTED IS WITHIN SAFE WINCH CAPACITY AS WELL AS SAFE CRANE CAPACITY. MULTI-PART LINE OPERATION IS REQUIRED WHEN SINGLE LINE LOAD CAPACITY OF WINCH IS EXCEEDED.
6. DO NOT OPERATE, WALK, OR STAND UNDER THE BOOM OR ANY SUSPENDED LOAD.
7. ALWAYS PAY OUT LOAD LINE BEFORE EXTENDING BOOM. WIRE ROPE DAMAGE AND / OR BREAKAGE MAY OCCUR.
8. BOOM MUST BE IN ITS REST BEFORE MOVING VEHICLE.
9. BOOM TIP MUST BE DIRECTLY OVER THE LOAD BEFORE ANY LIFTING IS STARTED. DO NOT DRAG LOADS WITH THIS CRANE.
10. MAINTAIN THIS CRANE AS REQUIRED IN THE OWNER'S MANUAL.
11. DO NOT ALLOW PERSONNEL TO RIDE ON THE LOAD LINE, LOAD, OR BOOM OF THIS CRANE.
12. IT IS UNLAWFUL TO OPERATE THIS EQUIPMENT WITHIN TEN FEET OF HIGH VOLTAGE LINE



F1122-B
05/12/08

HOUSTON, TEXAS
FAX: (800) 824-5559 (USA & Canada)
FAX: (713) 688-6324
PHONE: (713) 688-5533
www.iftmoore.com

THIS PAGE INTENTIONALLY LEFT BLANK



F1122-B
05/12/08

HOUSTON, TEXAS
FAX: (800) 824-5559 (USA & Canada)
FAX: (713) 688-6324
PHONE: (713) 688-5533
www.liftmoore.com

INTRODUCTION

This crane is a powerful machine designed to lift and move heavy loads. There are many hazards associated with these operations. Liftmoore has designed this crane to be as safe as possible but -

IT IS THE OPERATOR'S RESPONSIBILITY TO PREVENT ACCIDENTS!

This takes pre-planning, attention, and knowledge of basic principles and rules. Even if you have used similar cranes, reading this manual in its entirety will help prevent damage, injury, or even loss of life; benefits well worth the short amount of time it takes to read these pages.

REGULATORY AUTHORITY

Use of this crane is governed by OSHA 29 CFR 1910.180 and may be governed by other federal, state, or local regulations.

IT IS THE OPERATOR'S RESPONSIBILITY TO UNDERSTAND AND COMPLY WITH ALL APPLICABLE REGULATIONS GOVERNING THE OPERATION, INSPECTION, AND MAINTENANCE OF THIS CRANE.

Personnel should be trained, tested, and certified, as recommended by OSHA and ANSI standards, before operating this crane.

USING THIS MANUAL

This manual assumes that the crane is mounted on a typical service body type or similar truck, which is powered by the vehicle electrical or hydraulic system, and is controlled by either the standard pendant control or FM radio control sold by Liftmoore, Inc.

This manual is supplied to provide basic guidelines for the safe use, routine maintenance, and general inspections of this crane.

This manual is supplied to provide basic guidelines for the safe use, routine maintenance, and general inspections of this crane.

Laws, regulations, standards, or policies may be more restrictive than this manual. If a conflict exists for any limit or condition, the safest or most prohibitive shall be used. Under no circumstances shall the load, moment, or stability ratings be exceeded.

Pay particular attention to the following:

WARNING! – Draws attention to hazards, conditions, or procedures that if not observed could result in injury or death.

CAUTION! – Draws attention to hazards, conditions, or procedures that if not observed could result in damage to the crane, load, or other equipment. Equipment failure could in turn lead to injury or death.

NOTE! – Draws attention to conditions or procedures that are essential to emphasize.

For questions, interpretations, or to report errors, please contact Liftmoore, Inc, Engineering Dept.



F1111-D
09/30/09

HOUSTON, TEXAS
FAX: (800) 824-5559 (USA & Canada)
FAX: (713) 688-6324
PHONE: (713) 688-5533
www.liftmoore.com

OPERATING RESTRICTIONS

DUTY CYCLE

For Electric Cranes the duty cycle time should be limited to 10%. This is limited by heat buildup in the motors and declining charge in the batteries. (Installing extra batteries near the crane helps keep the voltage at maximum.) (applies to Electric pump and winch only)

PERSONNEL

LIFTING OR MOVING OF PERSONNEL IS STRICTLY PROHIBITED! This crane was neither designed nor intended to lift personnel. Under no circumstances should anyone be allowed to ride on the crane, line, or load. All non-essential personnel must be kept away when using the crane. The load must never be moved over people, nor must anyone be allowed to pass or stand under a suspended load.

ELECTRICAL LINES

Consult ANSI B30.5 for operating procedures, minimum safe distances, and prohibited zones when working around electrical lines or poles.

When operating near electrical power lines, the crane must be positioned so that the distance from the crane to the lines or poles is equal to or greater than the length of the fully extended boom plus the minimum safe distance required.

All parts of the crane, line, and load must be kept a minimum safe distance from electrical power lines and poles. This distance is 10 feet for electrical lines carrying 50kV or less.

UNDER NO CIRCUMSTANCES SHOULD A CRANE BE OPERATED UNDER ELECTRICAL POWER LINES.

REQUIRED CLEARANCE FOR NORMAL VOLTAGE IN OPERATION NEAR HIGH-VOLTAGE POWER LINES AND OPERATION IN TRANSIT WITH NO LOAD AND BOOM OR MAST LOWERED

Normal Voltage, kV (phase to phase)	Minimum required Clearance ft (m) [note (1)]
Operation Near High Voltage Power Lines	
Up to 50	10 (3.05)
Over 50 to 200	15 (4.60)
Over 200 to 350	20 (6.10)
Over 350 to 500	25 (7.62)
Over 500 to 750	35 (10.67)
<u>Over 750 to 1,000</u>	<u>45 (13.72)</u>
Operation in Transit With no Load and Boom or Mast Lowered	
Up to 0.75	4 (1.22)
Up to 0.75 to 50	6 (1.83)
Up to 50 to 345	10 (3.05)
Up to 345 to 750	16 (4.87)
<u>Up to 750 to 1,000</u>	<u>20 (6.10)</u>

NOTE:

- (1) Environmental conditions such as fog, smoke, or precipitation may require increased clearances.

OPERATING PRACTICES

SETUP

POSITION The vehicle must be positioned so that the load is kept as close to the crane base as possible to reduce the moment on the crane. Consideration must be given to starting and ending position as well as firmness and slope of the ground and any obstructions.

OUTRIGGERS The outriggers or jackstands must be firmly set and the vehicle as level as possible. This will reduce the stresses on the rotation drive and keep the load off the vehicle's suspension. Keep in mind that the weight on the vehicle will shift as the crane and load is rotated.

MANUAL BOOM EXTENSION If the manual extension part of the boom is



F1112-F
7/5/12

HOUSTON, TEXAS
FAX: (800) 824-5559 (USA & Canada)
FAX: (713) 688-6324
PHONE: (713) 688-5533
www.iftmoore.com

needed, it must be extended and the boom pin placed in the required position. Insert the pin and replace the pin's hairpin keeper before attempting to lift any load.

LOAD LIMIT The operator must understand the crane load chart. The operator must ensure that the load is within the load limits over the entire range which it will be moved. Be sure to include the weight of any lifting devices including the travel block.

The load limit chart is attached to the side of the crane to aid the operator.

The boom angle indicator and chart aids the operator in determining the load capacity at various boom angles and extensions. It also gives the load limit at that configuration.

STABILITY A stability chart must be posted near the crane. The operator must understand the stability chart. The crane may be de-rated over some areas of its operating radius.

TRAVEL BLOCK The operator must determine if the load is within the single line compatibility of the winch or if a multi-part line configuration is needed.

REEVING Ensure the proper routing of the rope through the sheaves and travel block. The rope must lie in the sheave groove and must not rub against any metal objects.

Ensure the rope is correctly wound on the winch drum. The crane assembly drawing will indicate if the rope must be wound over the top or bottom of the drum. The rope must never contact any part of the winch mounting.

WARNING!

If the winch winding direction is reversed the brake will not work and the load will fall.

ATTACHING THE LOAD

POSITION The boom tip must be moved over the load before lifting so that it will be lifted straight up.

CAUTION!

Never drag a load with the crane. Dragging a load puts very high stresses on the crane for which it was not designed.

ROPE Check the rope condition to ensure it is not frayed or damaged. Ensure that the rope is not kinked and that it does not contact any sharp edges or make any sharp bends.

If using double line configuration, ensure that the lines are not twisted.

CAUTION!

Never wrap the hoist rope around the load! Serious damage to the rope WILL occur.

HOOK Always make sure the load is applied to the throat of the hook. Never use a bent hook.

CAUTION!

Always lift with the throat of the hook. Never lift with the load applied to the tip of the hook. Doing so will bend the hook.

SLINGS If the load does not have a lifting eye, use a nylon, chain, or other type of sling designed for lifting and rated for loads greater than that being lifted.

BALANCE Ensure the load will be secure and balanced when lifted. Ensure that the load cannot shift in the sling and that the sling cannot slide across the hook should the load become unbalanced.



F1112-F
7/5/12

HOUSTON, TEXAS
FAX: (800) 824-5559 (USA & Canada)
FAX: (713) 688-6324
PHONE: (713) 688-5533
www.iftmoore.com

LIFTING THE LOAD

Before lifting, ensure that the load is free from all mountings and is no way attached or stuck to anything.

Ensure that at least five full wraps remain on the winch drum at all times.

Test the winch brake by lifting the load a few inches and ensuring that it does not slip.

HOLDING THE LOAD

The operator must keep the load in sight at all times once it is lifted.

The operator must never leave the controls once the load is lifted.

The operator must ensure that no one is allowed to pass or stand under a suspended load.

CAUTION!

Never move the vehicle with a suspended load. Doing so will put dynamic loads on the crane for which it was not designed.

MOVING THE LOAD

Before moving the load, make sure the path is free of any obstructions or people.

Avoid sudden accelerations or stops. Speeds must be kept to a minimum, especially rotation, to keep the load from swinging.

Avoid sudden reversing of direction. Do not reverse direction while the load is still moving.



Make sure that no part of the crane, boom, or load makes contact with any obstruction or comes within a minimum of ten feet from any electrical line.

TRANSIT



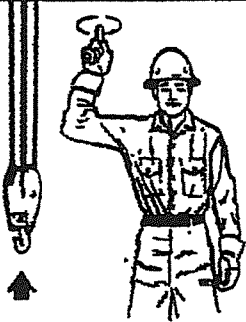
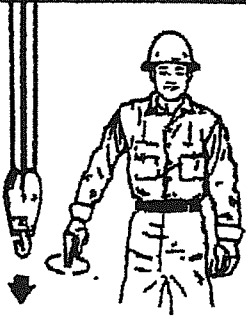
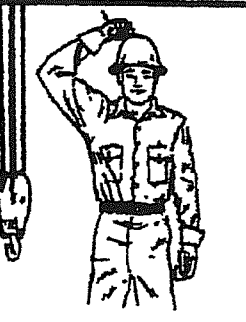

While in transit, the crane must be stowed, preferably in a boom rest. The crane must be prevented from rotating and the hook prevented from swinging.

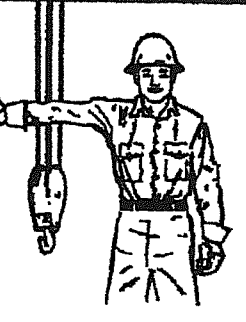
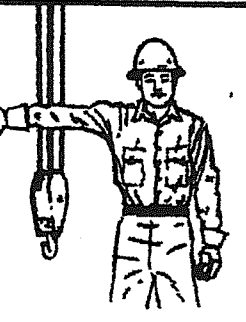
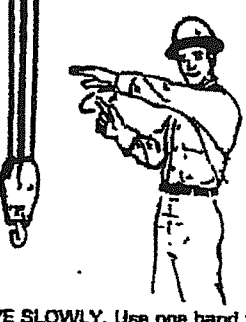
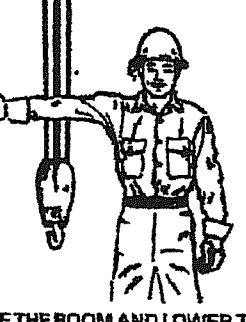
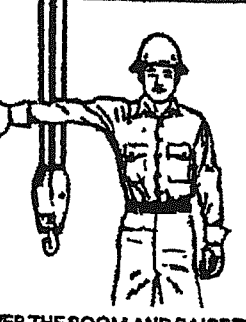

Standard Hand Signals for Controlling Crane Operations

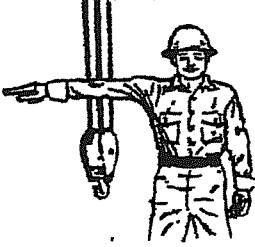
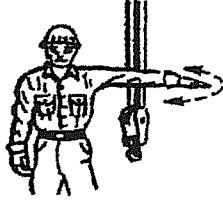
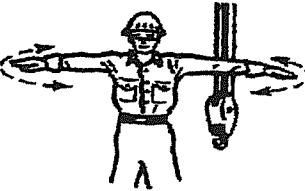
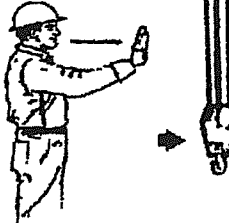
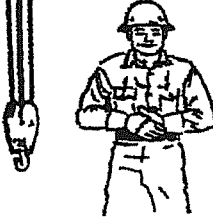
 <p>HOIST. With forearm vertical, forefinger pointing up, move hand in small horizontal circle.</p>	 <p>LOWER. With arm extended downward, forefinger pointing down, move hand in small horizontal circle.</p>	 <p>USE MAIN HOIST. Tap flat on head; then use regular signals.</p>
 <p>USE WHIPLINE (Auxiliary Hoist). Tap elbow with one hand; then use regular signals.</p>	 <p>RAISE BOOM. Arm extended, fingers closed, thumb pointing upward.</p>	 <p>LOWER BOOM. Arm extended, fingers closed, thumb pointing downward.</p>
 <p>MOVE SLOWLY. Use one hand to give any motion signal and place other hand motionless in front of hand giving the motion signal. (Hoist slowly shown as example.)</p>	 <p>RAISE THE BOOM AND LOWER THE LOAD. With arm extended, thumb pointing up, flex fingers in and out as long as load movement is desired.</p>	 <p>LOWER THE BOOM AND RAISE THE LOAD. With arm extended, thumb pointing down, flex fingers in and out as long as load movement is desired.</p>

Standard Hand Signals for Controlling Crane Operations (Cont'd)

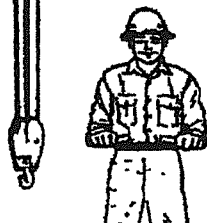
 <p>SWING. Arm extended, point with finger in direction of swing of boom</p>	 <p>STOP. Arm extended, palm down, move arm back and forth horizontally</p>	 <p>EMERGENCY STOP. Both arms extended, palms down, move arms back and forth horizontally.</p>
 <p>TRAVEL. Arm extended forward, hand open and slightly raised, make pushing motion in direction of travel.</p>	 <p>DOG EVERYTHING. Clasp hands in front of body.</p>	 <p>TRAVEL (Both Tracks). Use both fists in front of body, making a circular motion about each other, indicating direction of travel, forward or backward. (For land cranes only.)</p>
 <p>TRAVEL (One Track) Lock the track on side indicated by raised fist. Travel opposite track in direction indicated by circular motion of other fist, raised vertically in front of body. (For land cranes only.)</p>	 <p>EXTEND BOOM (Telescoping Booms). Both fists in front of body with thumbs pointing outward.</p>	 <p>RETRACT BOOM (Telescoping Booms). Both fists in front of body with thumbs pointing toward each other.</p>



HOUSTON, TEXAS
 FAX: (800) 824-5559 (USA & Canada)
 FAX: (713) 688-6324
 PHONE: (713) 688-5533
 www.iftmoore.com

Standard Hand Signals for Controlling Crane Operations (Cont'd)

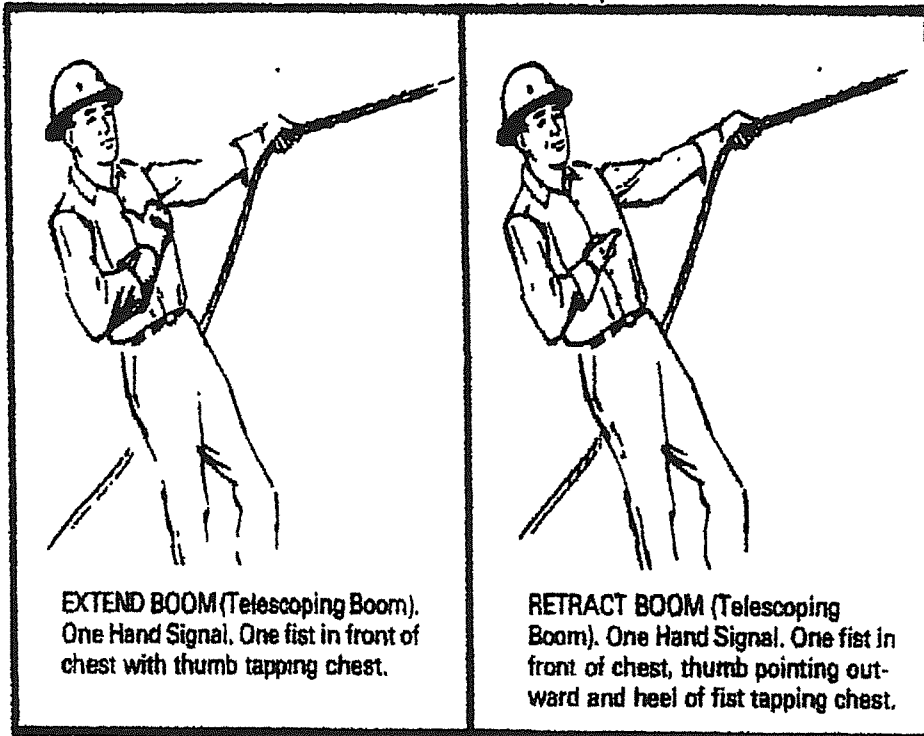

HOUSTON, TEXAS
 FAX: (800) 824-5559 (USA & Canada)
 FAX: (713) 688-6324
 PHONE: (713) 688-5533
www.liftmoore.com

INSPECTION AND MAINTENANCE

OSHA and ANSI require frequent and periodic inspections. Records of these inspections must be kept readily available. Liftmoore requires periodic maintenance to ensure proper operation and prolonged life of the crane.

INSPECTION

DAILY INSPECTION

OSHA 29CFR 1910.180 (d)(2)(i) requires the following be checked daily prior to use:

- All control mechanisms for maladjustment interfering with proper operation as well as for excessive wear of components and contamination by lubricants or other foreign matter.
- All safety devices for malfunction. This should include the anti-two block and pressure switch.
- Deterioration or leakage in air or hydraulic systems.
- Crane hooks with deformations or cracks. For hooks with cracks or having more than 15 percent in excess of normal throat opening or more than 10 deg. twist from the plane of the unbent hook.
- Electrical apparatus for malfunctioning, signs of excessive deterioration, dirt, and moisture accumulation. This should include the battery terminals, master disconnect switch, electrical swivel
- The wire rope shall be replaced if any of the following conditions are noted:

- Kinking, crushing, bird-caging, or other damage
- Reductions from nominal diameter of more than one-sixty-fourth inch for diameters up to and including five-sixteenths inch, one-thirty-second inch for diameters three-eighths inch to and including one-half inch.
- Thimble is not in place or is damaged
- Any evidence of heat damage
- Six or more randomly distributed broken wires in 1 lay
- Three or more broken wires in 1 strand in 1 lay

MONTHLY INSPECTION

A thorough inspection of all ropes in use shall be made at least once a month and a certification record which includes the date of inspection, the signature of the person who performed the inspection and an identifier for the ropes shall be prepared and kept on file where readily available. All inspections shall be performed by an appointed or authorized person. Any deterioration, resulting in appreciable loss of original strength shall be carefully observed and determination made as to whether further use of the rope would constitute a safety hazard. Some of the conditions that could result in an appreciable loss of strength are the following:

- Reduction of rope diameter below nominal diameter due to loss of core support, internal or external corrosion, or wear of outside wires.
- A number of broken outside wires and the degree of distribution of concentration of such broken wires.



F1113-D
10/27/10

HOUSTON, TEXAS
FAX: (800) 824-5559 (USA & Canada)
FAX: (713) 688-6324
PHONE: (713) 688-5533
www.liftmoore.com

- Worn outside wires.
- Corroded or broken wires at end connections.
- Corroded, cracked, bent, worn, or improperly applied end connections.
- Severe kinking, crushing, cutting, or unstranding.

PERIODIC INSPECTION

An Annual Inspection Form is included in this manual. OSHA 29CFR 1910.180 (d)(2)ii) requires periodic inspections of this crane. Liftmoore recommends an annual inspection using the included form.

MAINTENANCE PRECAUTIONS

The crane should be maintained monthly for safety reasons and to reduce stress on the crane.

WARNING!

Never perform any maintenance while the crane has any type of load on it. Use the manual operation procedure to lower the load if necessary.

WARNING!

Hydraulic cylinders may have high pressure stored in them even after hydraulic power is removed.

The counterbalance and pilot operated check valve in the cylinder will always hold some pressure in the cylinder. Slightly extending the cylinder then retracting a small amount will relieve most of the pressure in the cylinder. **DO NOT DEADHEAD THE CYLINDER!** This will store the maximum amount of pressure in the cylinder. Care should be taken when either valve is removed from the cylinder as some pressure will still remain.

After any maintenance has been performed the crane shall not be operated until all guards have been reinstalled, all safety

devices reactivated, and maintenance equipment removed.

LUBRICATION Refer to the crane specification section for the periodic maintenance schedule and type of lubrication required.

BOLTS Bolts may loosen over time due to vibration; therefore they should be checked periodically. If bolts need to be replaced, make sure they are replaced with bolts of equal or greater strength. Check the periodic maintenance schedule (Crane Specification Section) for bolt specification and torque.

NOTE!

Sheave and boom and cylinder pivot bolts are not standard bolts. The shank and thread length of these bolts have been modified so that they do not pivot on the threads. Consult the parts section of this manual for part numbers of these bolts.

OTHER MAINTENANCE

Refer to parts drawings for any specific maintenance or adjustment procedures such as hydraulic winch brake, rotation drive gear set adjustment, Ect.



MONTHLY INSPECTION REPORT

Crane Model No. _____ Serial Number _____

Are Boom Hitch Pins and Keepers in place?	Yes _____ No _____
Wire Line Hook with Safety Latch Working?	Yes _____ No _____
Is Hook OK, (Not bent)?	Yes _____ No _____
Is Thimble on Wire Rope OK?	Yes _____ No _____
Is Traveling Block in use?	Yes _____ No _____
Is Wire Rope OK, not kinked or frayed?	Yes _____ No _____
Are all Boom Sections straight?	Yes _____ No _____
Are Sheave Bolts in place and tight?	Yes _____ No _____
Do all Sheaves rotate easily?	Yes _____ No _____
Are Mounting Bolts tight?	Yes _____ No _____
Is Anti Two-Block functioning properly?	Yes _____ No _____
Is Boom Angle Indicator in place and functioning and is Chart legible?	Yes _____ No _____
Are Cylinder Mounting Bolts secure?	Yes _____ No _____
Are Winch Mounting Bolts tight?	Yes _____ No _____
When stopped does winch drift less than 1.0 Inches?	Yes _____ No _____
Is Load Chart in place and easily read?	Yes _____ No _____
Are functions on Pendant operating correctly?	Yes _____ No _____
Is Hydraulic Reservoir full?	Yes _____ No _____
Is Outrigger straight and functioning?	Yes _____ No _____

Any items checked 'No' must be repaired before using this crane.



F1123-B
03/26/07

HOUSTON, TEXAS
 FAX: (800) 824-5559 (USA & Canada)
 FAX: (713) 688-6324
 PHONE: (713) 688-5533
 www.liftmoore.com

ANNUAL CRANE CERTIFICATION (29CFR1910.180)

OWNER _____

MODEL NUMBER _____ SERIAL NUMBER _____

DATE _____

Check the following:

 Crane Mounting Bolts (Torque) Winch mounting Bolts (Torque) Boom mounting bolts Cylinder mounting bolts Cracks on boom (Check when extended) Extension Pads not worn excessively Cracks on housing Weld cracks on boom Weld cracks on housing Boom swing approximately one inch or less at boom tip when retracted Hydraulic leaks Hoses not chafed or cracked

Sheaves not cracked

 Boom Tip Traveling Block Sheaves not worn excessively Boom Tip Traveling Block Sheaves rotate freely Boom Tip Traveling Block

Load Chart in place and legible

 Boom angle chart in place and legible

 Labels in place (See manufacturer's chart)

 Crane Hook Throat Opening within 15% of standard

 Crane Hook not bent more than 10 degrees from plane

 Hook safety latch operating properly

 Booms pin(s) and Keeper(s) in place (Manual Extension Section)

 Wire Rope removed if the following occurs:

Six randomly distributed broken wires in one lay or three broken wires in one strand in one lay.

Wear of one-third the original diameter of outside individual wires.

Kinking, crushing, bird-caging or any other damage.

Evidence of heat damage.

Reduction from nominal diameter of more than one sixty-fourth inch for diameters to five-sixteenths diameter and one-thirty-second inch for diameters three-eighths to one-half inch.

 Wire Line installed as manufacturer requires.

 Protective covers in place

 Grease crane as required

Check fluid level

 Winch

 Gearbox

 Reservoir

Control system for proper operation *Winch Up and Down* *Boom Up and Down* *Boom In and Out* *Rotation CW and CCW**Anti Two-Block (Required on Power Extendible Cranes) interrupts:* *Boom Down* *Boom Out* *Winch Up* *Boom Up stopped by Up Limit Switch* *Outrigger or jackstand operable* *Outrigger crushing decal in place* *Outrigger and Jackstand operates properly* *Boom rest in place and used* *Load Sensor trips when overloaded* *Winch Down does not overrun when stopped* *Crane stability chart in place and visible.*

I certify that I have performed the above tests and that any deficiencies were corrected and now comply as above.

Signed _____

Print Name _____

Company _____

Address _____

City _____ *State* _____

I:\FORMS\F1507-0.doc

F1507-0
6/26/12

THIS PAGE INTENTIONALLY LEFT BLANK



HOUSTON, TEXAS
FAX: (800) 824-5559 (USA & Canada)
FAX: (713) 688-6324
PHONE: (713) 688-5533
www.iftmoore.com

PROPORTIONAL PENDANT CONTROL SYSTEM

(WIRED OR FM)

Liftmoore cranes are electrically controlled using the hand-held pendant, which works in conjunction with the crane control module to operate powered functions and precisely regulate speed.

PENDANT - WIRED

All user inputs are facilitated by the remote pendant control. The pendant consists of pistol grip housing, wire, and control plug. The control plug mates with the crane control socket. The control socket is usually mounted on the valve cover. Optionally, the socket may be mounted below the crane with wires installed through the crane's base.

The pistol grip housing contains an on/off switch, one momentary contact switch for each function, and a trigger for regulating speed.

CRANE CONTROL MODULE

The crane control module contains the proportional valve driver and the limiting system control. It consists of a single printed circuit board enclosed in a rugged, sealed housing. Status LEDs are located on the circuit board to aid in troubleshooting.

The proportional valve driver supplies a regulated voltage to the pendant trigger, interprets the signal returned from the trigger, and then outputs an appropriate signal to the proportional valve.

The limiting system control is part of the safety system. Refer to that section for more information.

OPERATION

Plug the pendant into the crane control socket. Ensure all pins are straight and free of dirt, moisture, and corrosion. Turn the

locking ring approximately 1/3 turn until it clicks into the locked position.

Turn the pendant control switch on.

Select the function switch and direction as indicated on the label for the desired operation.

WARNING!

Never pull the trigger before operating the selection switch. Doing so will cause sudden acceleration and uncontrolled motion of the load.

SLOWLY squeeze the trigger until the desired speed is reached. Do not operate the function any faster than necessary. Be especially careful when rotating loads to prevent swinging.

When stopping, slowly release the trigger before releasing the function switch.

CARE AND MAINTENANCE

The pendant control is designed to be as rugged and maintenance free as possible; however, care should be used in handling and storage as it is expensive to replace.

Follow these simple practices:

- Keep the pendant out of the weather
- When not in use, store the pendant inside the vehicle
- Do not wrap the wire too tightly as internal damage to the wires may result
- Do not place sharp or heavy object on the cord

NOTE!

The pendant is designed to be weatherproof not waterproof. It may be used in inclement weather, but if left outside or where water can puddle, water can seep inside.

Maintenance should be limited to routine inspection of the plug, wire, and fasteners.



SAFETY SYSTEM

The safety system is designed to help prevent damage to the crane that would be caused by overload or two-blocking. The system consists of a load sensor, anti-two block device (optional on smaller, electric cranes), and limiting system control board.

When the applicable switch detects an overloading or two-block condition, the limiting system will prevent activation of winch up, and extend out since these directions would cause damage. Winch down, boom down, boom up, extend in, and power rotation will still function so that the crane can be moved to a safe configuration.

CAUTION!

Never de-activate or override safety functions. Doing so can result in serious damage to the crane and possibly injury or death.

LOAD SENSOR

A pressure activated switch in the elevation cylinder acts as a load sensor. This switch is normally closed and opens at the preset pressure corresponding to the load rating of the crane.

CAUTION!

The load sensor will not function when the elevation cylinder is fully retracted and is inaccurate when the boom is below horizontal.

CAUTION!

The operator must never rely strictly on the load sensor to determine overload conditions. The load and load limits must always be known and adhered to.

ANTI-TWO BLOCK

The anti-two block device (optional on smaller electric cranes), mounted on the boom crown plate, consists of a normally open switch actuated by a lever. A weight is attached to the lever and holds the switch

closed. If the weight is lifted by the hook or travel block the switch opens.

The power and signal wires are wired through the cord reel, which is in turn wired to the ATB switch.

LIMITING SYSTEM CONTROL

Two systems are included to limit crane overloads and wire rope breakage. When a crane overload occurs, the load sensor will stop winch up, extension out and boom down. To prevent breaking the wire rope, the Anti Two-Block device stops winch up and extension out when either is engaged.

The capacity of boom up is limited by the pressure setting of the relief valve in the manifold.

There is a one second delay before the deactivation of boom down when the load sensor is tripped to prevent false readings caused by pressure spikes.

MISCELLANEOUS

UP LIMIT SWITCH

The up limit switch prevents the elevation cylinder from reaching full extension. If the elevation cylinder were to "dead-head", the resulting pressure would activate the load sensor, preventing boom down. The boom would then have to be lowered using the manual operation buttons on the solenoid valves.

CIRCUIT BREAKER, FUSE

For electric cranes a 150 Amp circuit breaker is supplied with the crane. It should be installed as close to the battery as possible. For hydraulic cranes a 10 Amp blade type fuse is supplied.

DISCONNECT SWITCH

A power disconnect switch is supplied with the crane. Power to the crane should be turned off whenever not in use. This is to prevent inadvertent or unauthorized use and will help prevent corrosion at electrical connections.



HYDRAULIC SYSTEM

Integrated Hyd Proportional

The hydraulic system consists of the hydraulic swivel, manifold with solenoid valves, cylinders, motors, and tubing and hoses. Hydraulic power is received from an external hydraulic source, typically a PTO driven pump attached to the vehicle transmission. The hydraulic system uses open center valves in series so that multiple functions can be operated simultaneously.

SWIVEL- (NOT USED IN 1032 OR 1640)

The hydraulic swivel is a two-port swivel that allows continuous, unlimited rotation. Refer to drawing for more information.

MANIFOLD - DWG 50771

The hydraulic manifold consists of a differential pressure sensing flow control valve, the system relief valve, proportional flow control valve, and 4 way directional control valves.

The Logic valve is a pilot operated pressure compensated flow control cartridge valve. It supplies the required flow to the manifold and returns excess flow to the tank so that pressure drop and heat build up are minimized.

The system relief valve prevents damage that would be caused by excessive pressure in the system. It is a cartridge type valve. Factory setting is 2800PSI.

The proportional valve is an electrically operated flow control valve. It allows the operator to control the flow, and therefore the speed, of the selected functions. The flow output is directly proportional to the electrical input. The valve may be operated manually by depressing the manual operation button on the top of the valve.

Each hydraulically operated function is controlled by a 4 way, 3 position open center solenoid valve. It is electrically operated and spring biased to center. A manual operation button is incorporated in the coil retaining nut.

CYLINDERS

Hydraulic cylinders are double acting cylinders with integrally mounted counterbalance valve and pilot operated check valves. Refer to the cylinder drawings for specific information.

All cylinders use a counter-balance load holding cartridge valve on the extend port. This valve performs 3 functions:

- Controls the rate of decent when lowering the load
- Keeps load from falling in the event of sudden loss of system pressure, such as when a hose bursts.
- Acts as a relief valve to prevent damage from induced load or thermal expansion.

It allows free flow to extend then blocks flow until opened by pilot pressure to the retract port or when the relief pressure is reached.

Some cylinders utilize a pilot operated check valve on the retract port to prevent the cylinder from creeping out under no load conditions. This valve allows flow into, but prevents flow from the retract port, thus hydraulically locking the cylinder until opened by pilot pressure to the extend port.

MOTORS

The hydraulic motors used by the rotation drive and hydraulic winch are high torque, low speed constant displacement motor.



MANUAL OPERATION

If electrical problems occur the solenoid valves may be operated manually. Refer to the manifold drawing for function valves and directions.

Directional control valves are manually operated by depressing the boot at the end of the valve. Use a blunt object (e.g. bolt or screwdriver handle) to assist in the operation.

Proportional valves are operated with either a boot or a small screw. Depress the boot or turn the screw slowly while operating a function to determine optimum speed. Turning the screw all the way in will result in rapid crane movement.

If hydraulic power is lost while a load is suspended, the load may be lowered by decreasing the setting on the counterbalance valve. This should only be done in extreme cases. The valve must be reset before the crane is returned to use.

To decrease the setting, loosen the locknut on the valve, then slowly turn the adjustment stem **CLOCKWISE** until the load begins to lower. Count the number of turns so that the valve can be returned to its original setting.

Alternately, a pressure gage must be put on the retract port to adjust the setting so that approx. 1800 PSI is required to lower the boom with no load.

Test the setting by lifting a known load near the moment rating of the crane.



BASIC TROUBLESHOOTING

The following chart gives a quick reference to help identify and correct problems. Refer to the following pages for more detailed information.

PROBLEM	PROBABLE CAUSE	CORRECTIVE ACTION	
NO FUNCTIONS WORK	<p>Not receiving electrical power</p> <p>Not receiving hydraulic power</p> <p>Control problem</p>	<p>Check all connections Check all fuses and circuit breakers Check for electrical power at first electrical connection and trace back to crane</p> <p>Check flow from pump Deadhead cylinder and check pressure at pump</p> <p>See control section</p>	
FUNCTION NOT WORKING	<p>winch up, extension out not working</p> <p>Boom down, winch down, extension in not working</p> <p>Other function not working</p>	<p>No signal from ATB or Load sensor (switch tripped, bad switch, bad wiring or not receiving power)</p> <p>Relay card malfunction</p> <p>Not receiving enough pressure</p> <p>Faulty wiring</p> <p>Valve coils bad</p>	<p>Check input signal to relay board if no signal, trace back to switch</p> <p>Check LEDs on board for error codes and outputs</p> <p>Deadhead cylinder and check pressure at pump</p> <p>Check differential pressure valve for contamination</p> <p>Check relief valve for proper setting and possible contamination</p> <p>Check all wiring for breaks or shorts Check all ground wires for good connection</p> <p>Check coil resistance</p>
ALL FUNCTIONS SLOW	<p>Not receiving enough flow</p> <p>Low battery voltage Check with engine running</p> <p>* Proportional valve problem</p> <p>* Control problem</p>	<p>Check fluid levels Check all filters and any other restrictions</p> <p>Charge battery (BATTERY MAY BE BAD)</p> <p>Try manual operation of proportional valve</p> <p>Check voltage at valve for approx. at min and max(see troubleshooting form for specific valves)</p> <p>See control section</p>	



F1774-0
11/02/10

HOUSTON, TEXAS
FAX: (800) 824-5559 (USA & Canada)
FAX: (713) 688-6324
PHONE: (713) 688-5533
www.liftmoore.com

CONTROL TROUBLESHOOTING CHART

WIRE PENDANT

No functions working	Not receiving power	<p>Check crane control socket Pin E ensure that it is receiving 12V</p> <p>With the plug disconnected, activate a function switch then check continuity between Pin E and the activated function/direction pin</p> <p>For example: activate Hoist Down and check for continuity between Pin E and Pin P</p>
One function not working	Faulty wiring/switch malfunction	With the plug disconnected, activate the function that is not working and check for continuity between Pin E and corresponding function pin
<p>All functions slow</p> <p>(APPLIES TO PROPORTIONAL CRANES ONLY)</p>	<p>Trigger problem</p> <p>Valve driver problem</p>	<p>Check Crane RELAY BOX for Error Codes and Proportional Output Voltage</p> <p>Calibrate valve driver board</p>

FIGURE

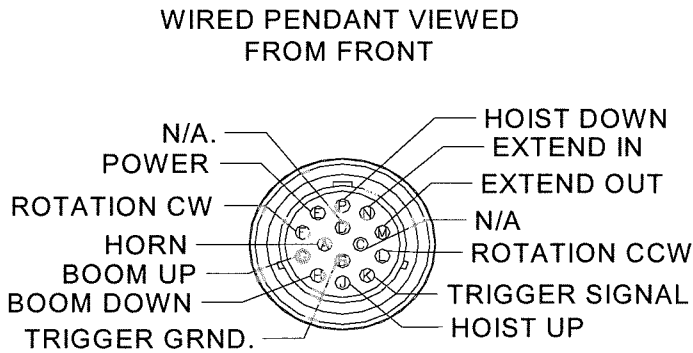

To Display an error code, the controller turns on and off the error code LED a certain number of times with a pause at the end. It repeats the code until the problem is resolved. The **Error Code Chart** is provided to assist the service personnel in troubleshooting the system.

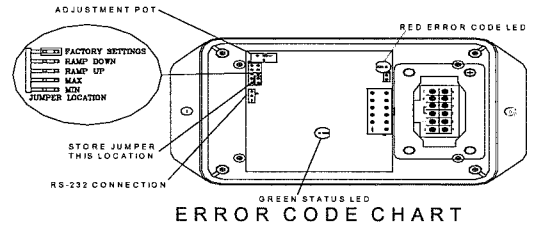

ERROR CODE CHART

ERROR CODE COUNT	PROBABLE CAUSE
1	No Input To ATB Switch Input
2	No Input To Pressure Switch Input Or Overload Condition
3	Short Or Overload To Winch Up Output
4	Short Or Overload To Elevation Down Output
5	Short Or Overload To Extension Out Output
6	Trigger Input Out Of Range

Figure 2 CONTROL PLUG ON PENDANT 24694

**Figure 1 RELAY BOX
SEE DWG**



TROUBLESHOOTING HYDRAULIC CRANES

GENERAL

If a problem exists, always start with the basics and work towards the more complicated.

First ensure that the crane is receiving full voltage and the pump is generating full flow and pressure. Typical requirements are 12VDC, 6GPM, and 2750PSI. Refer to the crane specification sheet for specifics.

Next determine if the problem is electrical or hydraulic. In general, if the crane can be operated manually, then the problem is electrical. If manual operation does not work then the problem is hydraulic.

If no function is working the problem may be loss of electrical or hydraulic power. Make sure that the crane is getting power. Also make sure that the system is getting power.

If functions do not work under load or if hoist down, boom down, and extend in do not work the problem is likely lack of pressure. This may be caused by inadequate supply pressure or malfunction or contamination in the DPS or system relief valve.

If hoist up, boom down, or extend out do not work, the problem may be in the safety system. If all three of these functions do not work and other functions do the problem must be in the safety system. The status indicators on the crane control module circuit board should confirm any errors.

If the crane has proportional control and either no functions work or all functions are slow, refer to the proportional troubleshooting section.

SAFETY SYSTEM

To check functions controlled by the safety system check the status indicators. If only one of the safety functions is not working,

activate that function and check for error codes and/or its output status indicator.

For non-FM systems, if the status indicator lights then the problem is in the wiring or in the solenoid coil. If the light does not illuminate, check the control pendant. If the control pendant is good then the crane control module needs to be replaced.

For FM systems, check for error codes. If none are present, see the FM Troubleshooting section.

If all three safety functions are not working confirm that the control board has power. Confirm that the board is receiving a signal from the ATB and load sensor. If the board is not receiving both signals Error Code 4 (Error Code 4 or 5 for the FM) should be active.

If the error code is active, ensure that the crane is not overloaded and that the ATB lever is holding the switch closed. Check for voltage at the ATB and Load Sensor inputs.

CHECK LOAD SENSOR SWITCH

If the load sensor input is not receiving voltage, locate the load sensor connector inside the crane housing. The plug side will have a red wire and a gray wire, the receptacle side will have a red and a white wire.

Disconnect and check for continuity between the two pins on the receptacle (switch side). If there is no continuity then the load sensor is bad and needs to be replaced.

CHECK ATB SWITCH

If the ATB input is not receiving voltage remove the ATB housing cover and disconnect the connector. Check for continuity on the switch side. Lifting the weight should break the continuity. If either of these conditions is incorrect the switch is bad and needs to be replaced.

CHECK CORD REEL

Check the ATB switch if not done so already. Locate the ATB connector inside the crane



housing. The plug side will have a red wire and a black wire. The receptacle side will have a white wire and a black wire.

Disconnect the plug going to the switch. Check for continuity between the two pins on the receptacle. Have someone lift the weight on the ATB and continuity should be broken. If either of these conditions are incorrect then the cord reel is bad and needs to be replaced.

CHECK POWER TO SAFETY SWITCHES

If the safety switch is good, check for voltage at pin 1 (the red wire) on the plug. If there is no voltage, follow the wire back to the 6-pin power distribution plug, checking for breaks or shorts.

Remove the power distribution receptacle (cap).

NOTE!

Removing the cap will disconnect power to all electrical components. Be sure to replace the cap before continuing.

Check the cap for bent pins. Check that all wires are fully seated in the plug. If they are not, then remove the green locking wedge and push the wires forward until seated. Reinstall the wedge ensuring that no wires are pushed back.

Check the input voltage to the plug (the pin the fuse holder is connected to). If there is no voltage there, then no component will get power. Check the fuse in the crane and any other fuse or circuit breaker that may be installed. Start at the battery and trace the wiring back to the crane checking for power at each component until the problem is found.



SOLENOID VALVES

If one function does not work, try to operate it manually. If it does not work either the solenoid or the applicable actuator is malfunctioning. Contact Liftmoore for more information.

If it works manually, then the problem is electrical. Disconnect the electrical connector going to the applicable solenoid valve.

Check the voltage between the applicable direction pin on the plug (harness side) and ground. When the switch is activated, the voltage should be 12V (battery voltage).

If no voltage is received, check the continuity between the pin and the applicable pin on the crane control socket. If there is no continuity, then a wire must be broken. If the wiring is good, then the problem is with the control pendant.

If the voltage checks good, check the resistance on the coil. Connect an ohmmeter to the applicable pin on the receptacle and ground. The resistance should be between 5 and 6 ohm. If the resistance is near zero then the coil is shorted and needs to be replaced.

If the circuit is open then check where the coil is grounded on the valve. Also check for continuity between the manifold and the crane. If there is no continuity, remove one of the manifold mounting bolts and clean under the head and reinstall.

PENDANT (NON-FM)

If no functions work, check that Pin E on the crane control socket has power.

If the crane control socket is getting power, then check that the power wire is not broken. Select a function and direction then check continuity between pin E and the activated function/direction on the pendant control plug. If there is no continuity then the pendant needs to be repaired or replaced.

If a function is not working, check continuity between that function and Pin E on the pendant control plug. There should be continuity once the switch is activated in selected direction. The continuity should break when the switch is released. If not, the pendant needs to be repaired



TROUBLESHOOTING THE PROPORTIONAL SYSTEM

21398 HALL EFFECT, 12V Diplomatic Coil

If no functions work or if all functions are slow when controlled by the pendant, but work correctly when the manual operation button is pressed on the proportional valve then the problem is with the proportional electronic control system.

Proportional Valve Parameters

Cracking voltage	2.6V
Full open voltage	7.75V
Coil Resistance	3.66Ω

CHECK VOLTAGE AT VALVE

Have the engine running to generate sufficient voltage (13-14V). As the trigger is pulled the valve voltage should start near zero, jump to the valve cracking voltage after slight trigger travel, increase steadily as the trigger is pulled, reaching the full open voltage.

If the voltages are correct, check the resistance across the coil. If the resistance differs significantly from the nominal resistance replace the coil.

THE FOLLOWING APPLIES TO NON-FM CONTROL SYSTEMS ONLY. FOR FM SYSTEMS, REFER TO THE FM TROUBLESHOOTING SECTION OR CONTACT LIFTMOORE, INC FOR MORE INFORMATION.

VALVE DRIVER BOARD CALIBRATION

Refer to Relay Board Drawing .

Remove the relay board from the Deutsch box.

WARNING!

DO NOT allow board to contact any metal object.

Slightly pull the trigger (to obtain minimum voltage), hold, and use a screwdriver to turn R1 CCW to decrease- CW to increase. Next, fully pull the trigger (to obtain maximum voltage), hold, and turn R2 CCW to decrease- CW to increase. The voltage of R1 might change as R2 is changing or vice versa. Recheck the Min and the Max voltages. If voltage is correct, reassemble the board; otherwise, repeat.

If problem persists contact Liftmoore, Inc. for further instructions.



SECTION 3 CRANE SPECIFICATIONS

MODEL 2550 CRANES

MOMENT RATING 25 000 FT-LBS

MAX SINGLE LINE LOAD 2 500 LBS

MAX DOUBLE LINE LOAD 5 000 LBS

LIFTING CAPACITIES AT VARIOUS LOAD RADII:

LOAD RADIUS (FT)	CAPACITY (LBS)
≤ 5	5000
8	3125
10	2500
12	2083
14	1785
16	1562
18	1388
20	1250

POWERED FUNCTIONS AND APPROXIMATE TIMES:

WINCH	UP: 5 s	DOWN: 5 s	1 REVOLUTION
BOOM ELEVATION	UP: 12 s	DOWN: 10 s	
BOOM EXTENSION	OUT: 14 s	IN: 10 s	
ROTATION	90° 16 s		

HYDRAULIC REQUIREMENTS:

PRESSURE	2500 PSI
FLOW	6 GPM

ELECTRICAL REQUIREMENTS:

VOLTAGE	12 VDC
FUSE	15 AMP

NOTE: FUNCTION TIMES ARE BASED ON THESE INPUT VALUES



F1133-D
12/17/08

HOUSTON, TEXAS
FAX: (800) 824-5559 (USA & Canada)
FAX: (713) 688-6324
PHONE: (713) 688-5533
www.liftmoore.com

PERIODIC MAINTENANCE SCHEDULE		
MODEL 2550 CRANES		
BOLTS		
MOUNTING BOLTS	7/8-9 GRADE 8 TORQUE 600FT-LBS DRY	EVERY 4 MONTHS
BEARING BOLTS	5/8-11 GRADE 8 TORQUE 220FT-LBS DRY	EVERY 4 MONTHS
LUBRICATION		
GREASE FITTINGS	SEE DRAWING 50048	EVERY OTHER WEEK
HYDRAULIC FLUID	STANDARD Chevron AW Hydraulic Oil 46 or equivalent SAE 15 weight oil COLD WEATHER AW 32 or equivalent SAE 10 weight oil	CHECK DAILY, FILL AS NEEDED
WINCH GEARBOX	Sunep 460 or equivalent ISO Grade 460 or AGMA Grade 7EP	EVERY MONTH
ROTATION GEARBOX	Sunco Prestige 740 EP or NLGI Grade 0	EVERY MONTH
BEARING (ZERK AND TEETH)	Oil Center Research PM 600 Military grease or equivalent Benton Based Grease NLGI Grade 2	EVERY 6 HOURS OF OPERATION
BOOM	Coat with "Slip Plate" made by Superior Graphite or similar solid lubricant coating	AS NEEDED



F1133-D
12/17/08

HOUSTON, TEXAS
FAX: (800) 824-5559 (USA & Canada)
FAX: (713) 688-6324
PHONE: (713) 688-5533
www.liftmoore.com

CRANE LUBRICATION POINTS

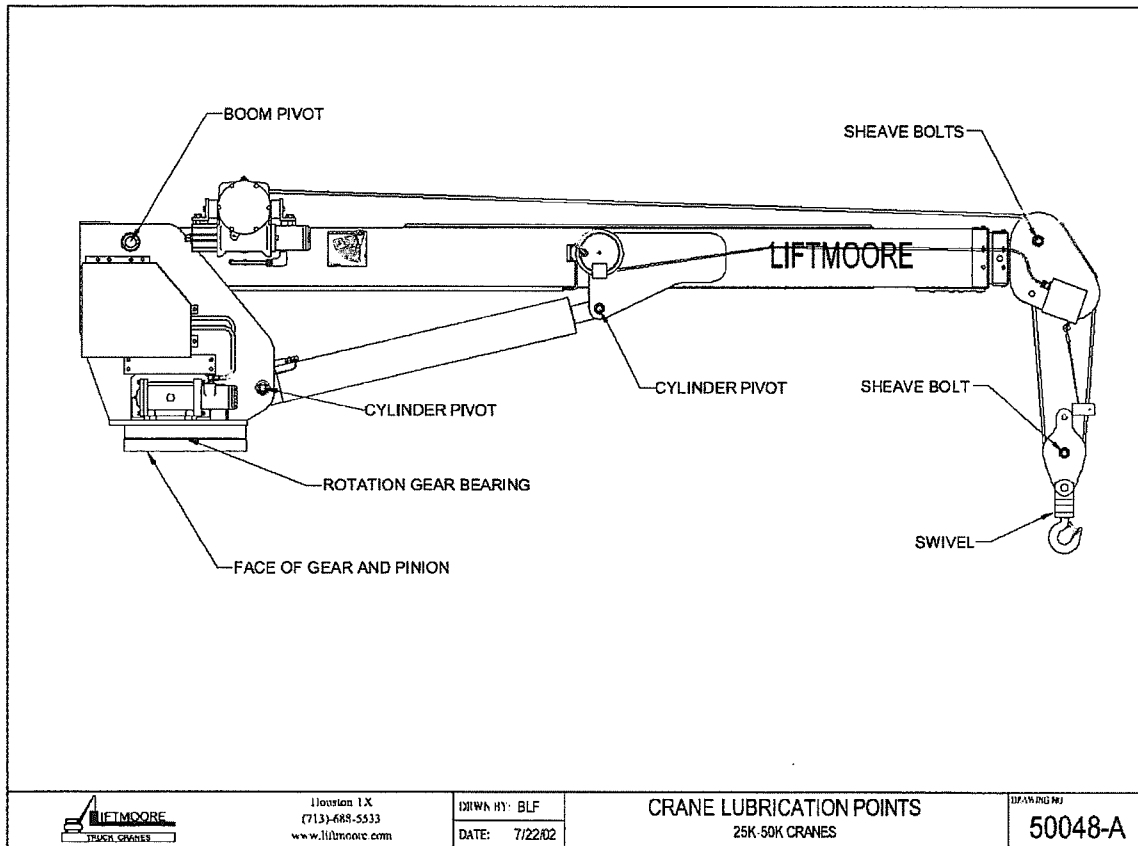

F1133-D
12/17/08

HOUSTON, TEXAS
 FAX: (800) 824-5559 (USA & Canada)
 FAX: (713) 688-6324
 PHONE: (713) 688-5533
 www.liftmoore.com

THIS PAGE INTENTIONALLY LEFT BLANK



F1133-D
12/17/08

HOUSTON, TEXAS
FAX: (800) 824-5559 (USA & Canada)
FAX: (713) 688-6324
PHONE: (713) 688-5533
www.liftmoore.com

LIST FOR BOX, CRANE PARTS 2550XP

Items with * have detailed DWG's.

P/N 25189 - BOX, CRANE PARTS 2550XP-16
ATB LS;W/HORN, GAUGE

- 1) P/N 25188 - MANUAL, CRANE 2550XP-16 HE.....1pc
- 2) *P/N 22910 - BLOCK, TRAV ASSY 5.0K LBS/5.3D.....1pc
- 3) P/N 22912 - LINK, COUPLING G-10-10.....1pc
- 4) P/N 19487 - CW, 10 GA X 300".....1pc
- 5) P/N 18457 - FUSE HOLDER, ATO 12GA SEALED.....1pc
- 6) P/N 21154 - FUSE, 30 AMP BLADE.....1pc
- 7) P/N 32613 - ADAPTER, 8MJ-10MJ.....1pc
- 8) P/N 17012 - SWITCH, TOGGLE SPST MAINT. /S1pc
- 9) P/N 17011 - BRACKET, SWITCH MNT. HYD. CRN.....1pc
- 10) P/N 16781 - TERMINAL, RING 10-12 GA #8.....2pcs
- 11) P/N 17013 - PLATE, ON-OFF FOR TOGGLE SWCH.1pc
- 12) P/N 22426 - INSTALLATION INTS. 2550,3660..1pc
- 13) P/N 18600 - PLATE, CRANE-TRUCK STABILITY CHART.....1pc
- 14) P/N 22379 - DECAL, LOAD CAPACITY 25K-10-20.....1pc
- 15) P/N 23144 - LEVEL & TAPE ASSEMBLY.....1pc



F1982-0
09/24/12

HOUSTON, TEXAS
FAX: (800) 824-5559 (USA & Canada)
FAX: (713) 688-6324
PHONE: (713) 688-5533
www.liftmoore.com

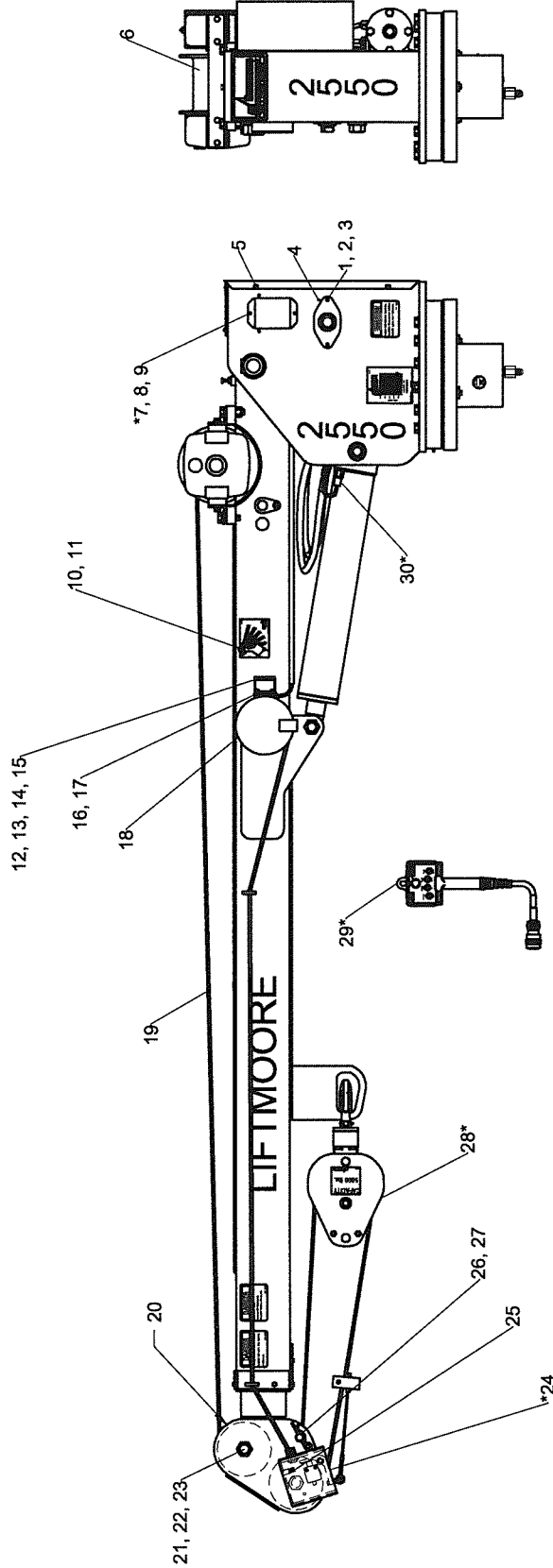

ITEMS WITH * HAVE DETAIL DRAWINGS

#	PN	DESCRIPTION	QTY	#	PN	DESCRIPTION	QTY	#	PN	DESCRIPTION	QTY
1	25125	EWI, DTCH HYD 3RD G XP ATB-BD	1	15	30457	SCREW, HHC 0.25-20 X 0.75 GR5	2	29	24694	CONTROL, PENDANT XP HALL TRIG	1
2	30457	SCREW, HHC 0.25-20 X 0.75 GR5	2	16	33410	SCREW, MH RD 10-24 X 3.00	1	30	20415	SWITCH, PRES ASSY 2050PSI DTCH	1
3	30889	WASHER, LOCK 0.25 GR5 PLATED	2	17	33409	NUT, HEX NYLOC 10-24 GR2	1				
4	30989	SCREW, HWHSMS #8 X 0.50	1	18	20407	REEL, CORD 20 FT ASSY DTCH	1				
5	32589	SCREW, HWHSMS 0.25-20 X 0.75	4	19	30608	ROPE, WIRE 0.31 X 80" W/TH&LP	1				
6	30528	SCREW, SET 0.37-16 X 0.75	1	20	21108	SHEAVE ASSY 5.31PD X 0.31 ROPE	2				
7	22569	BOARD, RELAY 3RD G XP ATB-BD	1	21	34468	SCREW, SHEAVE SINGLE 1-8 3.25	2				
8	17164	SCREW, SOC HD 10-24 X 0.62 SS	2	22	31258	WASHER, FLAT 1.00 SAE GRADE 8	2				
9	32639	WASHER, LOCK #10 GR2 PLATED	2	23	30838	NUT, HEX NYLOC 1.00-8 GRADE 5	2				
10	22394	PENDULUM, LOAD RADIUS DIA. HD	2	24	22908	ATB ASSY, DEUTSCH CONNECTOR	1				
11	31017	SCREW, SHOULDER 0.31-18 X 0.75	2	25	32957	CLAMP, HOSE SUPPORT 0.62 ID	1				
12	70012	BRACKET, CORD REEL	1	26	32658	PIN, CLEVIS 0.87 X 3.50 PLATED	1				
13	30833	NUT, HEX NYLOC 0.25-20 GR2	2	27	31948	CLIP, HAIRPIN 0.87 - 1.00	1				
14	31110	WASHER, FLAT 0.25 GR5 PLATED	2	28	22529	BLOCK, TRAV ASSY 5.0K LBS/5.3D	1				

NOT SHOWN:

- 19847 CONNECTOR, DTCH 2P PLUG
- 19845 CONNECTOR, DTCH 2P RECPT
- 19846 WEDGE, DEUTSCH 2P PLUG
- 19848 WEDGE, DEUTSCH 2P RECPT
- 19020 PLATE, SERIAL 5000W-2-PRT LINE
- 31865 DECAL KIT 2550-16 & 2550X-16
- 23123 PRESSURE GAUGE, 0-3000 PSI
- 23135 ADAPTER, 4FP-6FJ SWIVEL

LIFTMOORE
TRUCK CRANES

Houston TX
(713)-688-5533
www.liftmoore.com

DRWN BY: JE

DATE: 9/21/12

CRANE ASSY 2550XP-16 E-STOP

L.S. ATB, E-STOP, S.D. VALVES, HORN, GAUGE

DRAWING NO.
25187-0

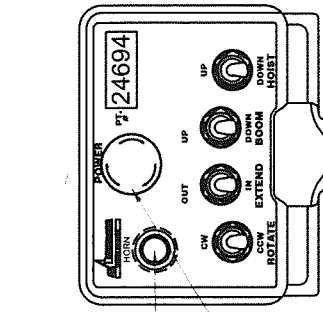

P/N 23121
PUSH BUTTON ASSEMBLY

P/N 23117
SWITCH, E-STOP TWIST RELEASE

P/N 22558
CONNECTOR, CGB 3/4 NPT FLEX

P/N 15566
TERMINAL P.O FEMALE 14-16 GA

P/N 32118
TERMINAL P.O MALE 14-16 GA

SOLDER WIRES
TO E-STOP SWITCH
3" WHT

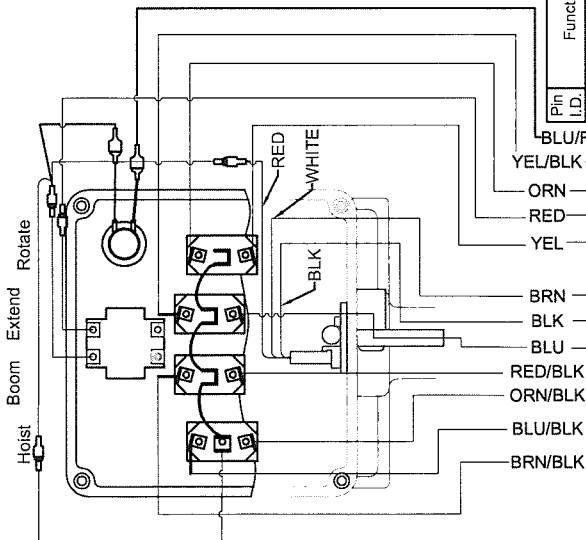
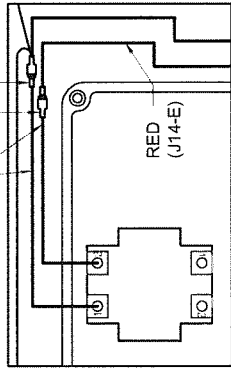

Pin ID.	Function	Color	Color Code 'B'
A	HORN	BLU/RED	N/A
B	TRIGGER GRND	BLK	BLK/WHT
C	SEAL PIN	N/A	N/A
D	SEAL PIN	N/A	N/A
E	POWER	RED	WHT
F	ROTATION CW	YEL	RED
G	BOOM UP	RED/BLK	GRN
H	BOOM DWN	BRN/BLK	ORN
J	HOIST UP	ORN/BLK	BLU
K	TRIGGER SIGNAL	BRN	WHT/BLK
L	ROTATION CCW	ORN	RED/BLK
M	EXTEND OUT	BLU	GRN/BLK
N	EXTEND IN	YEL/BLK	ORN/BLK
P	HOIST DOWN	BLU/BLK	BLK

- COLOR CODE B IS USED FOR REPAIR

NOTE: TIE OFF BLK/RED & ORG/RED
PLUG ORG/RED WIRE WITH BLUE MALE P/N 32118

WIRE COLORS ARE FOR ORIGINAL PENDANT
MADE WITH 16 CONDUCTOR CABLE.
REPLACEMENT CABLES MAY HAVE
DIFFERENT NUMBER OF CONDUCTORS
AND DIFFERENT COLORS.
CONTACT LIFTMOORE, INC IF COLOR CODE
DOES NOT MATCH CURRENT CONDITION OF PENDANT.

P/N 15838
YELLOW TERMINAL, P.O. MALE
10-12 GA.

P/N 32118
TERMINAL P.O MALE 14-16 GA

3' RED x 3

P/N 15566
TERMINAL P.O FEMALE 14-16 GA

P/N 19976 - PLUG, CONTROL 14-PIN DEUTSCH KIT

Houston TX
(713)-688-5533
www.liftmoore.com

DRWN BY: JE

DATE: 10/25/11

DRAWING NO.
24694-0

3RD GENERATION RELAY BOARD	
Pin No.	Description
1	Ground
2	Trigger Signal Input
3	Proportional Valve Output
4	Pressure Switch Input
5	ATB Switch Input
6	Winch Up Switch Input
7	Elevation Down Switch Input
8	Extension Out Switch Input
9	Extension Out Output
10	Elevation Down Output
11	Winch Up Output
12	Supply (9 To 30 VDC)

ERROR CODE CHART

ERROR CODE COUNT	PROBABLE CAUSE
1	No Input To ATB Switch Input
2	No Input To Pressure Switch Input Or Overload Condition
3	Short Or Overload To Winch Up Output
4	Short Or Overload To Elevation Down Output
5	Short Or Overload To Extension Out Output
6	Trigger Input Out Of Range

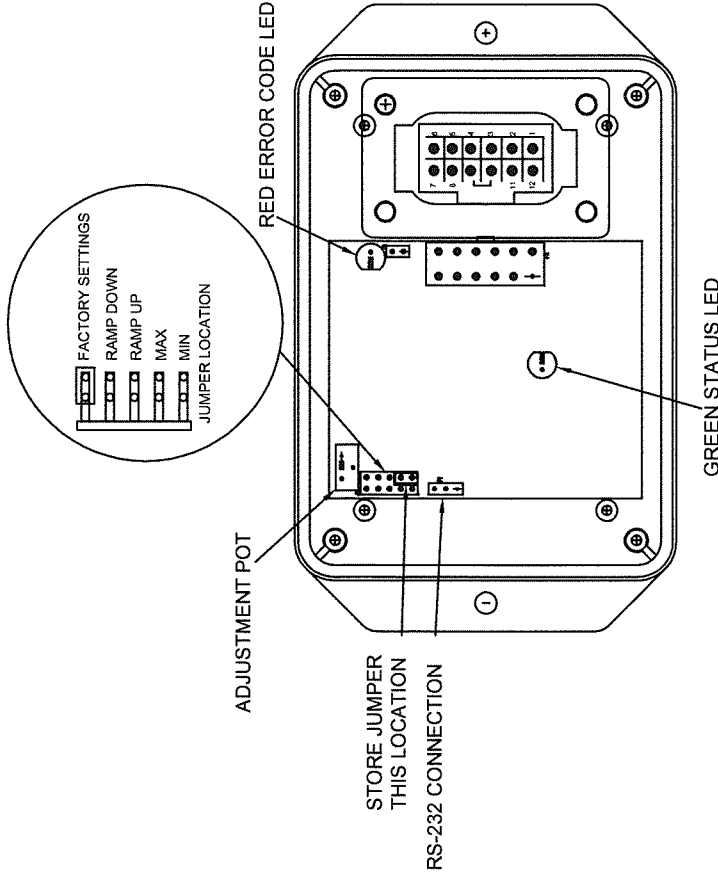

To Display an error code, the controller turns on and off the error code LED a certain number of times with a pause at the end. It repeats the code until the problem is resolved. The **Error Code Chart** is provided to assist the service personnel in troubleshooting the system.

DRAWING NO.
22569-A

BOARD, RELAY 3RD G XP ATB-BD
ATB DOES NOT STOP BOOM DOWN

DRWN BY: JC
DATE: 06/11/07

Houston TX
(713)-688-5533
www.iftmoore.com



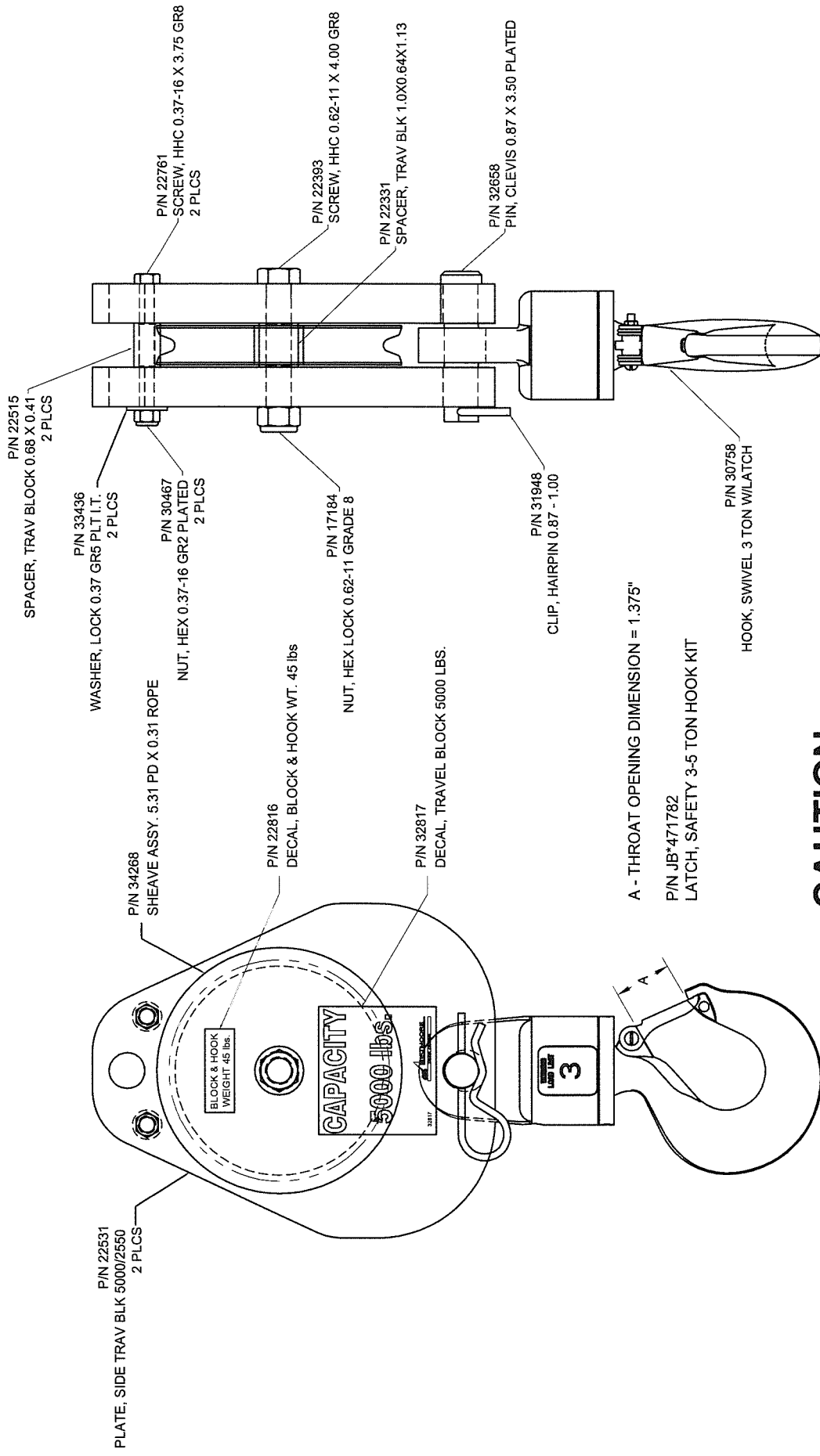

CAUTION:

NEVER USE A HOOK WHOSE THROAT OPENING HAS BEEN INCREASED, OR WHOSE TIP HAS BEEN BENT MORE THAN 10 DEGREES OUT OF PLANE FROM THE HOOK BODY, OR IS IN ANY WAY DISTORTED OR BENT.

Houston TX (713)-688-5533 www.liftmoore.com	DRWN BY: JC	BLOCK, TRAV ASSY 5.0K LBS/5.3D 5.31PD X 0.31 ROPE; 5K LBS	DRAWING NO. 22529-F
	DATE: 6/23/08		



NOTE: WIRE SHOULD BE SECURED TO SHEAVE BOLT TO ENSURE THAT IT DOES NOT INTERFERE WITH THE LEVER

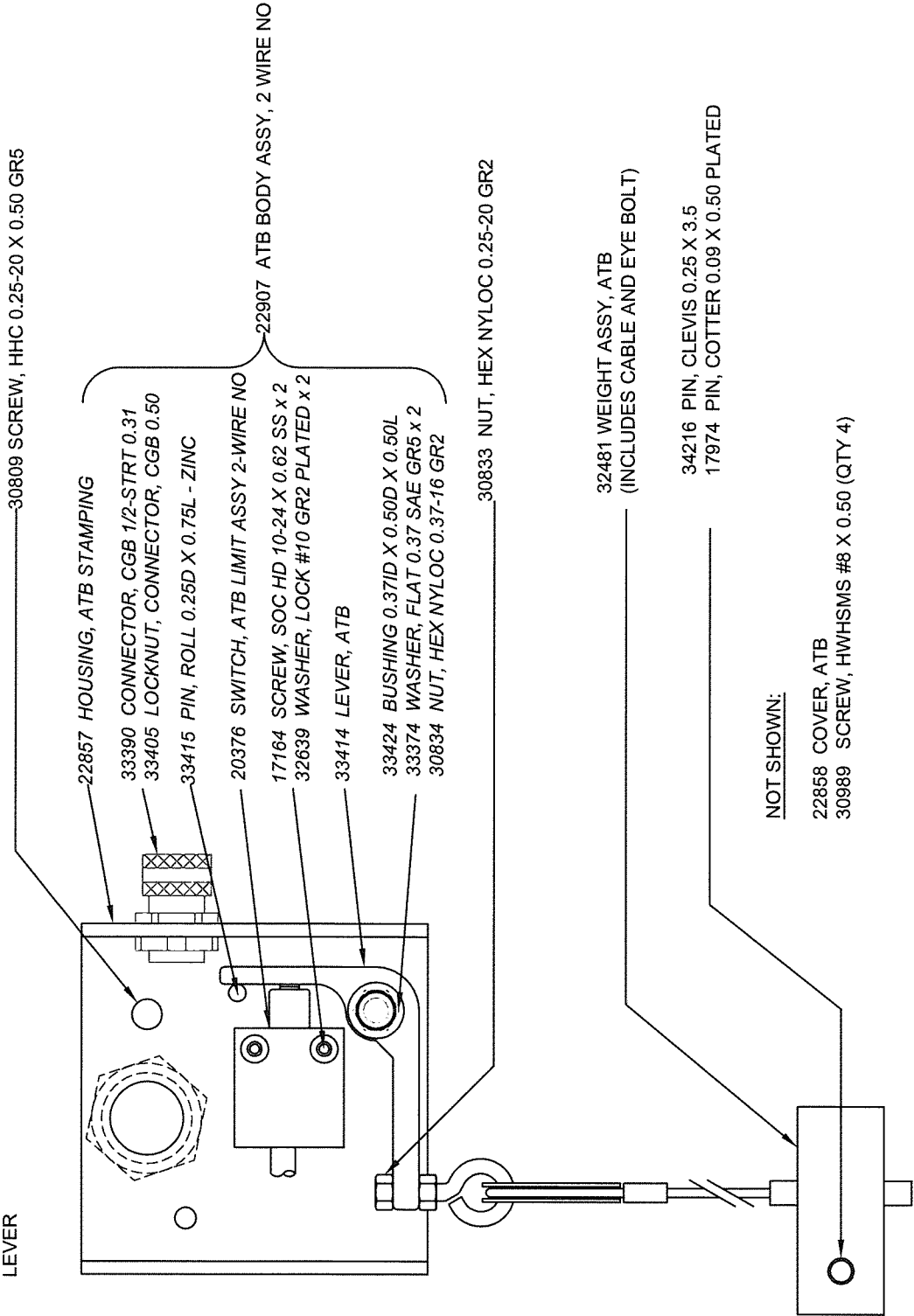

DRAWING NO.
22908-A

ATB ASSY, DEUTSCH CONN
TWO-WIRE NORMAL OPEN; LEFT SIDE

DRWN BY: JC
DATE: 07/02/09

Houston TX
(713)-688-5533
www.lifmoore.com



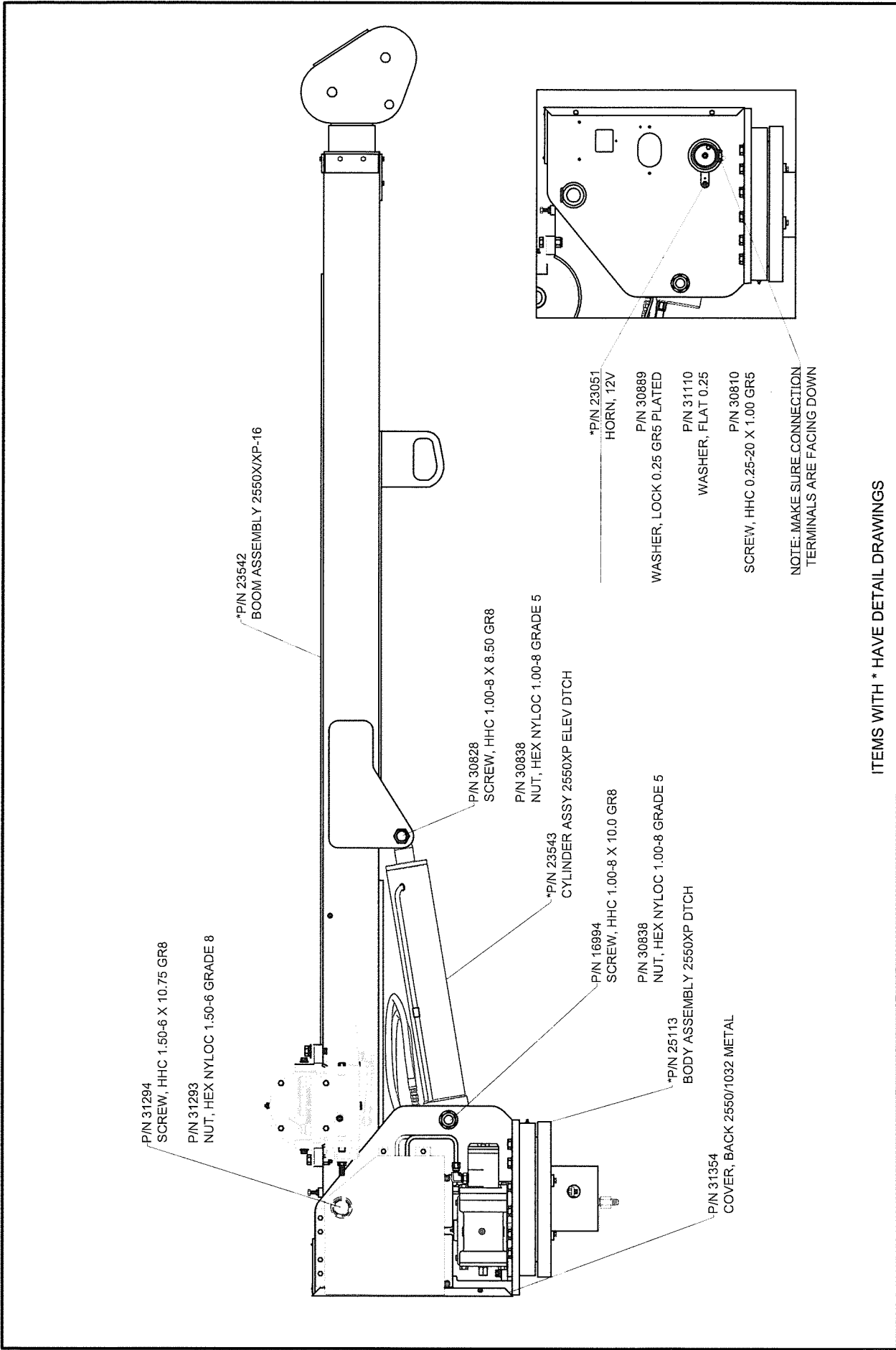

ITEMS WITH * HAVE DETAIL DRAWINGS

DRWN BY: JE
DATE: 8/29/12

Houston TX
(713)-688-5533
www.liftmoore.com



BOOM-BODY ASSY 2550XP-16 DTCH
ATB L.S.; NEW MANIFOLD, HORN, GAUGE

DRAWING NO.
25115-0

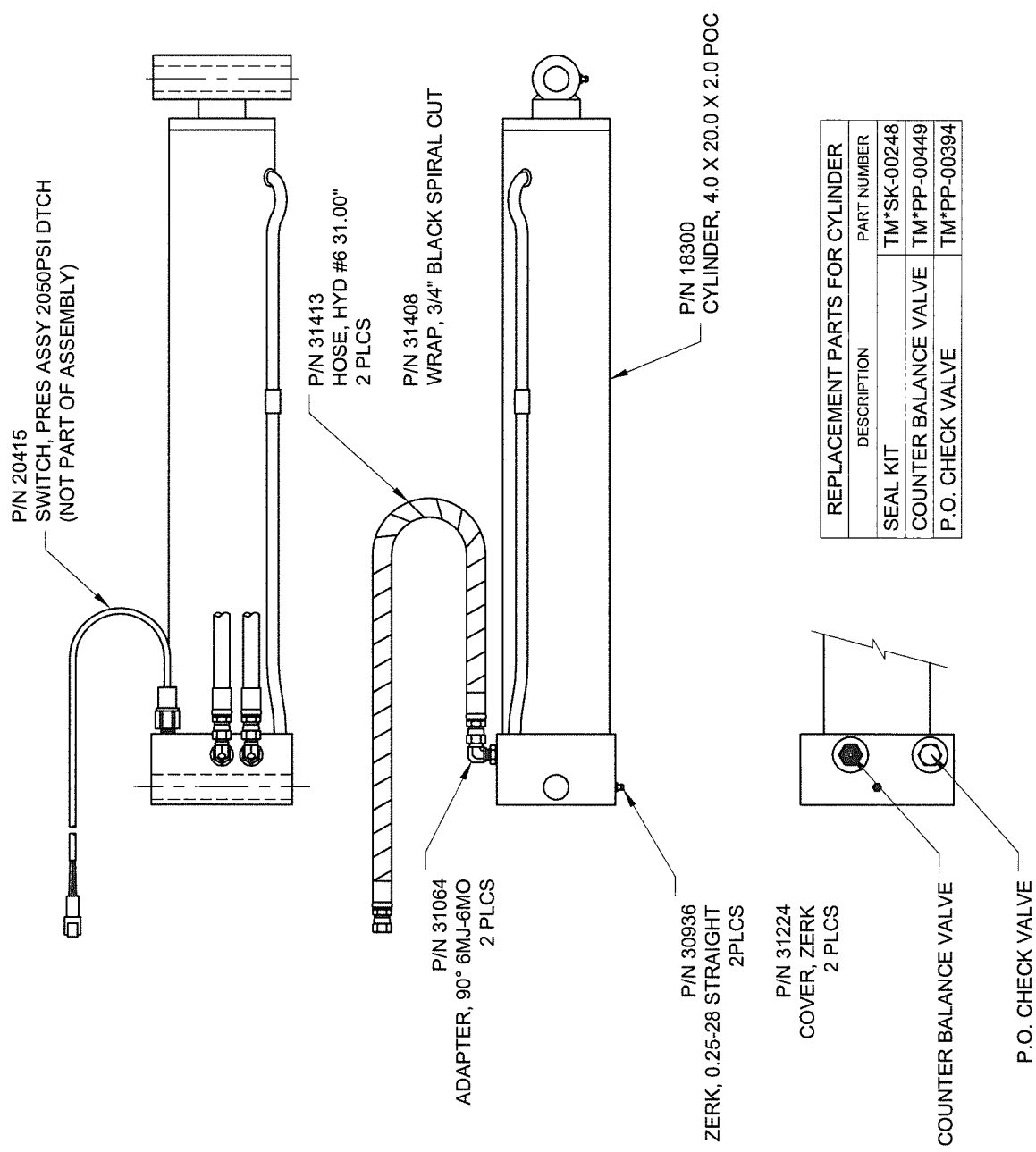

REPLACEMENT PARTS FOR CYLINDER	
DESCRIPTION	PART NUMBER
SEAL KIT	TM*SK-00248
COUNTER BALANCE VALVE	TM*PP-00449
P.O. CHECK VALVE	TM*PP-00394

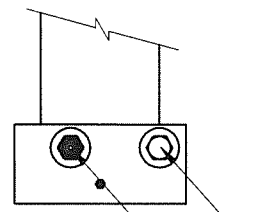

DRAWING NO.
23543-A

CYLINDER ASSY 2550XP ELEV DTCH
W/ BEST METAL CYLINDER

DRWN BY: JC
DATE: 02/26/10

Houston TX
(713)-688-5533
www.iftmoore.com



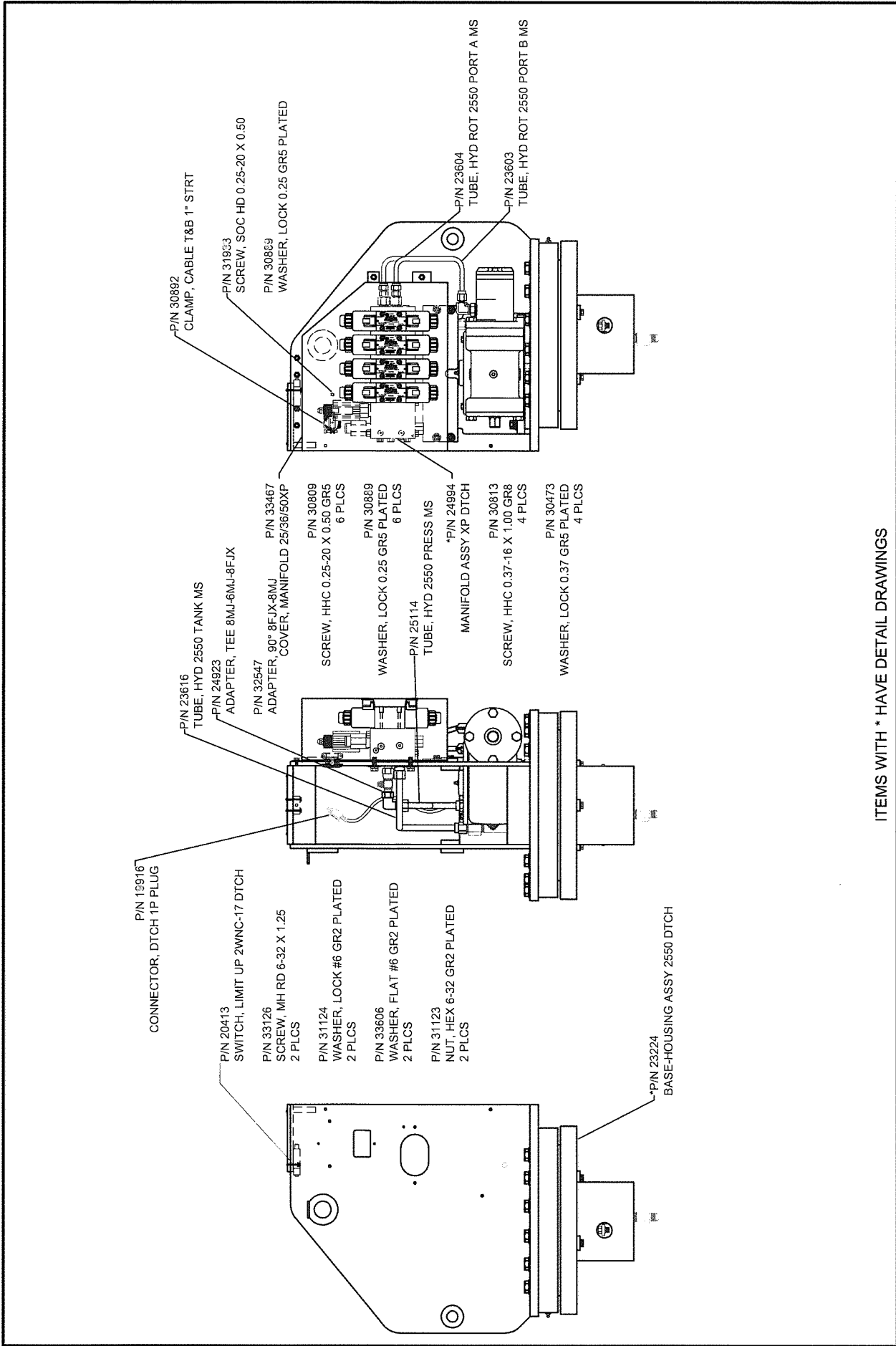

ITEMS WITH * HAVE DETAIL DRAWINGS

Houston TX
 (713)-688-5533
 www.lifmoore.com



BODY ASSEMBLY 2550/2525 XP
 FOR BOTH R.B.; SAUER DANFOSS VALVES MANIFOLD

DRAWING NO.

25113-0

DRWN BY: JE
 DATE: 8/28/12

BACK VIEW

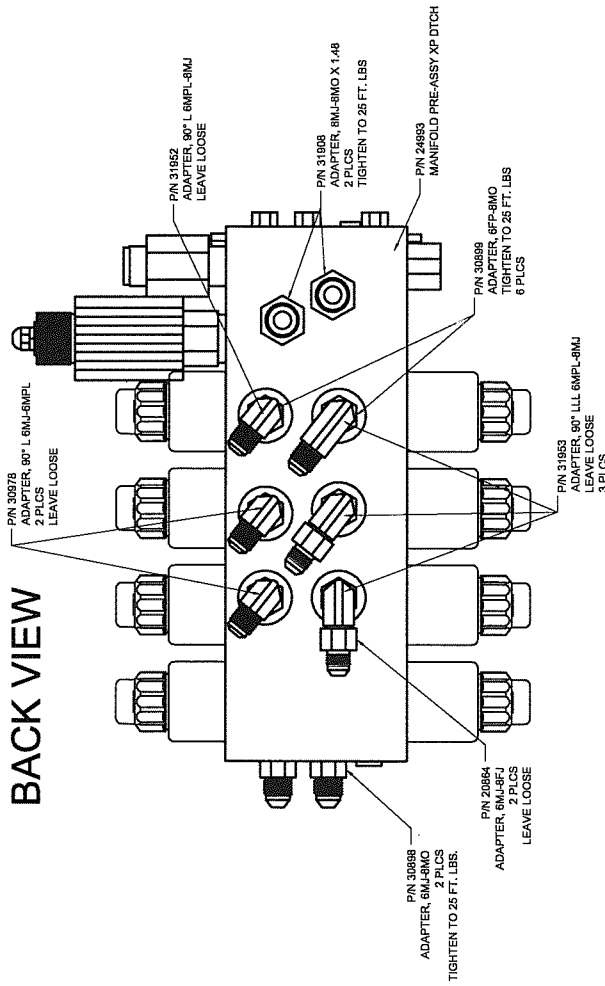

FRONT VIEW

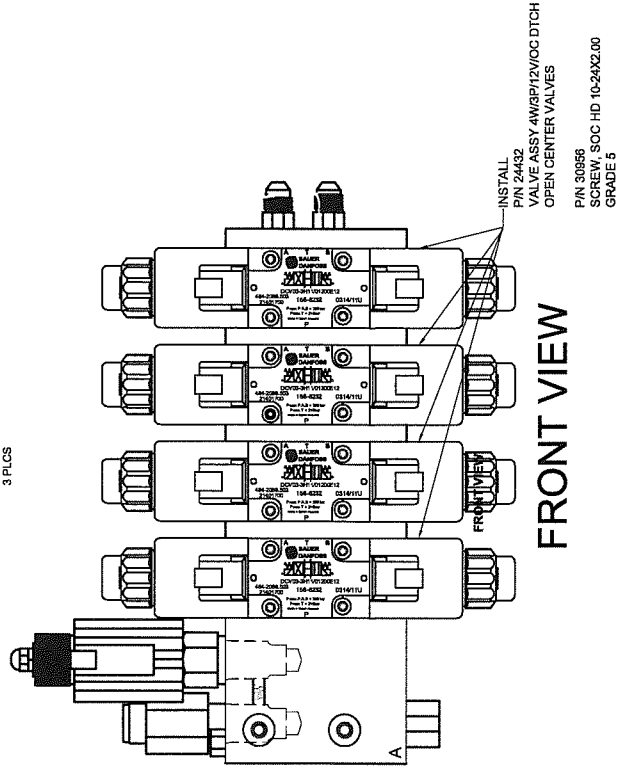

DRAWING NO.
24994-0

MANIFOLD ASSY XP DTCH
FOR 2550, 3660

DRWN BY: JE
DATE: 6/8/12

Houston TX
(713)-688-5533
www.liftmoore.com



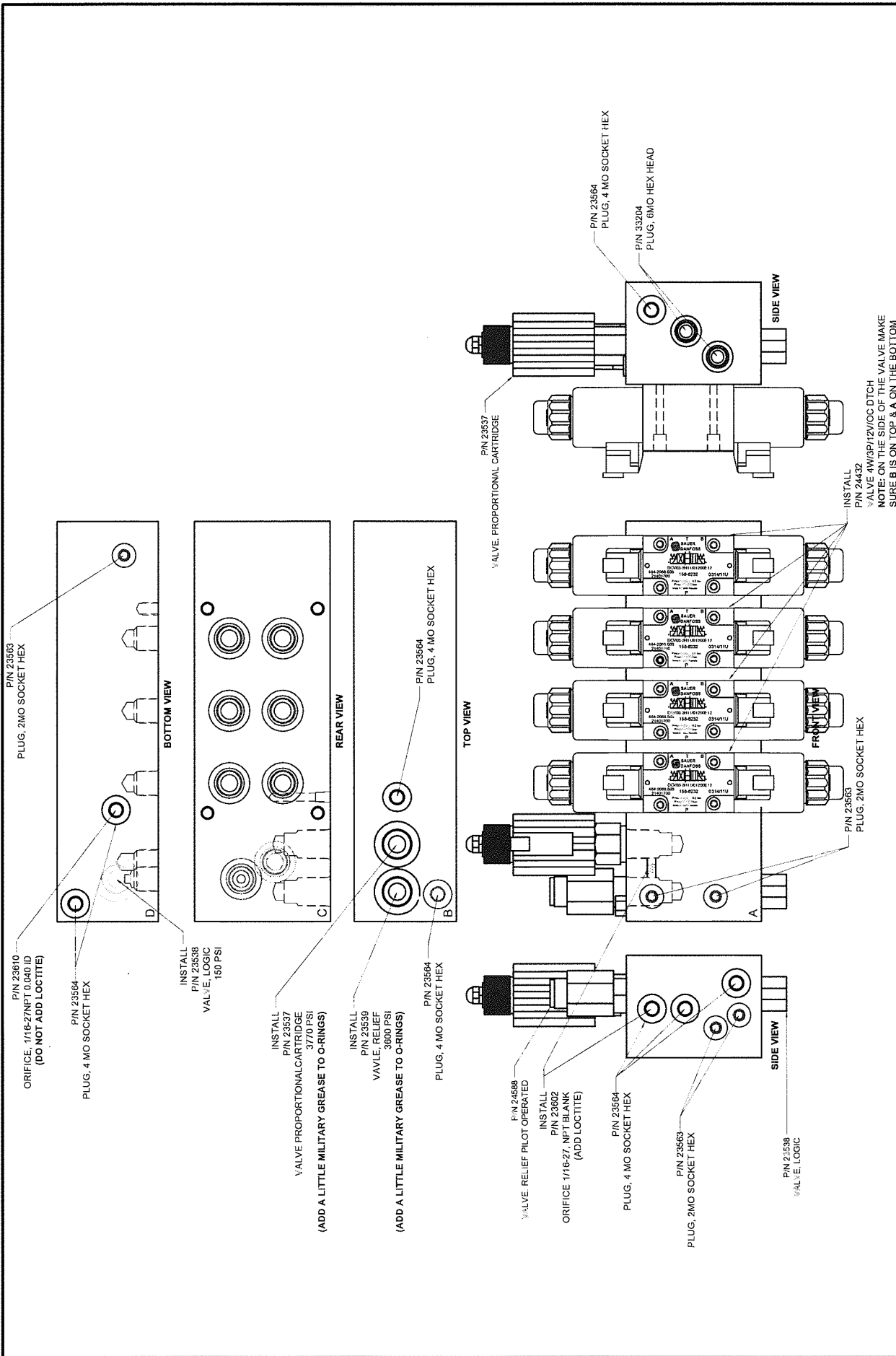

DRAWING NO.
24993-0

MANIFOLD PRE-ASSY XP DTCH

DRWN BY: JE
DATE: 6/4/12

Houston TX
(713)-688-5533
www.liftmoore.com



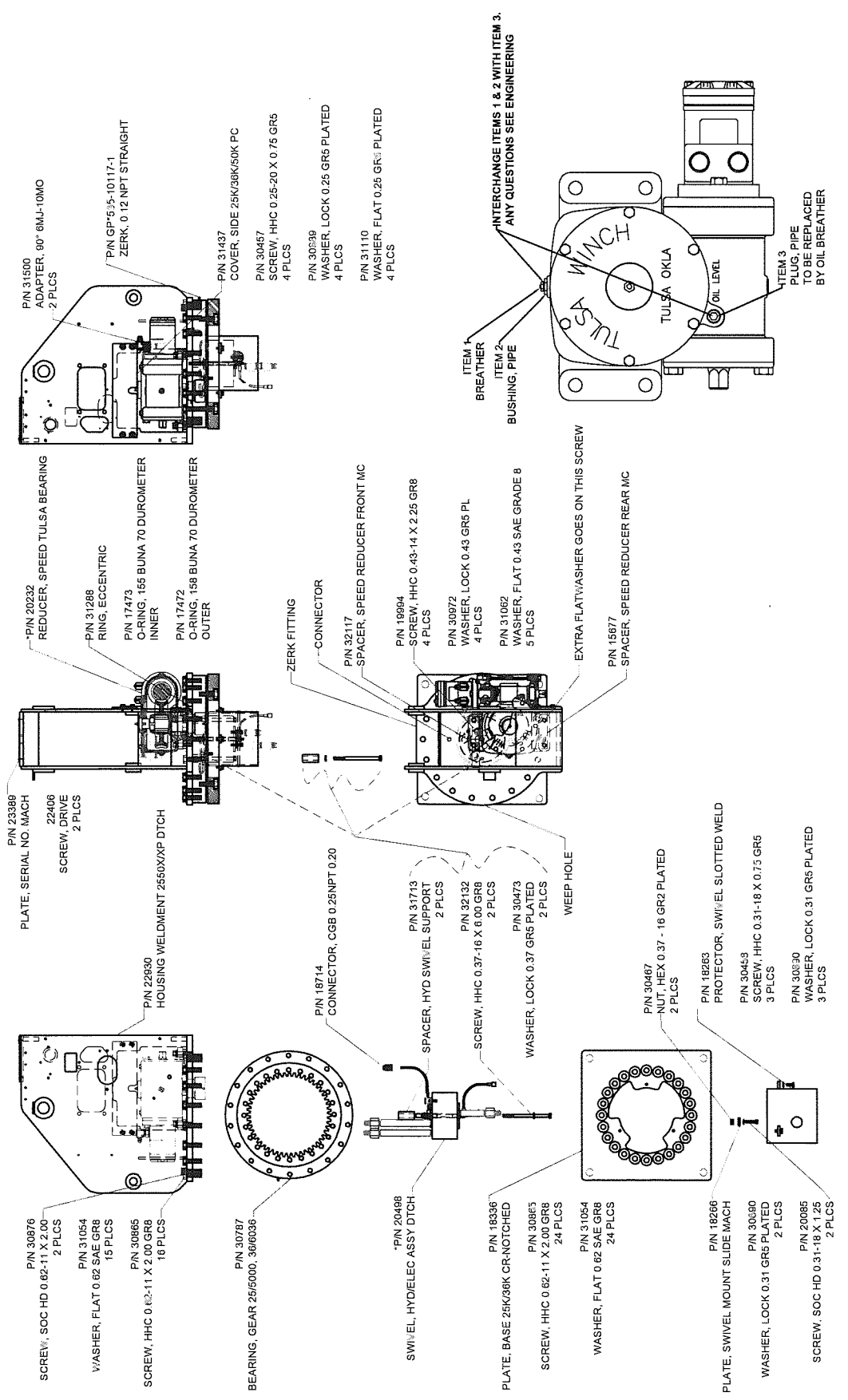

ITEMS WITH * HAVE DETAIL DRAWINGS

DRAWING NO.
23224-D

BASE-HOUSING ASSY 2525/2550
FOR 22209, 19742 & 21398 R.B.

DRWN BY: JC
DATE: 12/14/09

Houston TX
(713)-688-5533
www.lifmoore.com



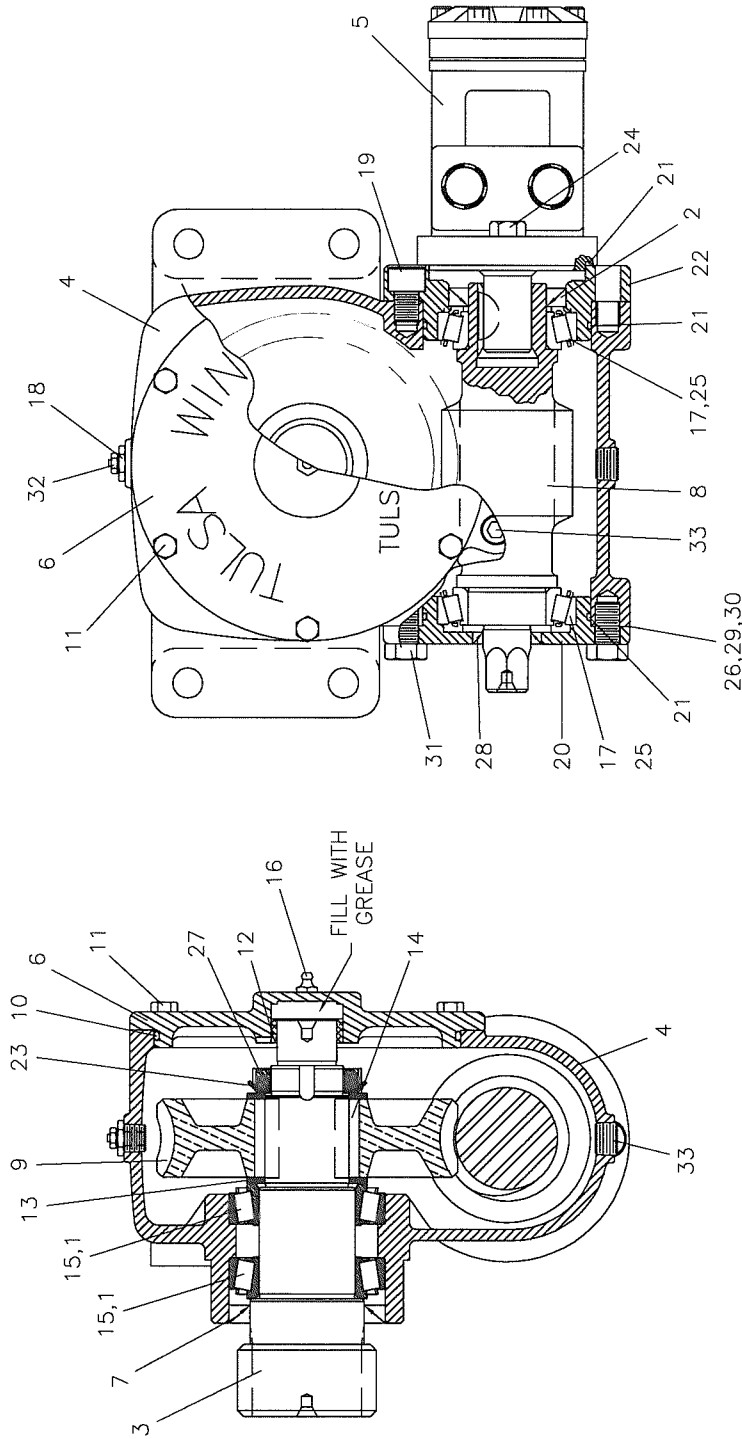

#	PN	DESCRIPTION	QTY	#	PN	DESCRIPTION	QTY	#	PN	DESCRIPTION	QTY
1	TW*41983	CUP, BEARING, HFG93	2	13	TW*40510	WASHER, THRUST	2	25	TW*996516	CUP, BEARING	2
2	TW*33155	SEAL, OIL	1	14	TW*40518	KEY	2	26	TW*42366	SHIM, G1600D	2
3	TW*43742	SHAFT, OUTPUT, PINION	1	15	TW*41982	CONE, BEARING, HFG9	2	27	TW*26628	LOCKNUT	1
4	TW*43492	HOUSING, 900D	1	16	TW*21128	FITTING, GREASE ZERK	1	28	TW*24180	SEAL, OIL	1
5	TW*42765	MOTOR, HYDRAULIC	1	17	TW*996515	CONE, BEARING	2	29	TW*42367	SHIM, G1600D	2
6	TW*42000	COVER, HFG938D	1	18	TW*12208	BUSHING, PIPE	1	30	TW*42368	SHIM, G1600D	2
7	TW*41979	SEAL, OIL, HFG938D	1	19	TW*43537	CAPSCREW, SOCKET HEAD	2	31	TW*24943	CAPSCREW	4
8	TW*43745	WORM, SR, HFG945D	1	20	TW*43467	CAP, END, 900D	1	32	TW*20375	BREATHER	1
9	TW*42578	GEAR, SR, HFG945D	1	21	TW*32566	O-RING	3	33	TW*32220	PLUG, PIPE	2
10	TW*40547	O-RING	1	22	TW*43465	CAP, END, MOTOR	1	34	TW*709169	PAINT, WHITE	1
11	TW*40407	CAPSCREW	6	23	TW*41299	LOCKWASHER	1				
12	TW*17451	BUSHING, HFG900D	1	24	TW*10381	CAPSCREW	2				

Houston TX
 (713)-688-5533
 www.iftmoore.com



REDUCER, SPEED TULSA BEARING

DRAWING NO.

20232-0

DRWN BY: SJN

DATE: 9/5/02

NOTE

ON THE BOTTOM OF THE SWIVEL, THE TANK PORT USES A #10 FITTING, AND THE PRESSURE PORT USES A #8 FITTING.

TANK SIDE

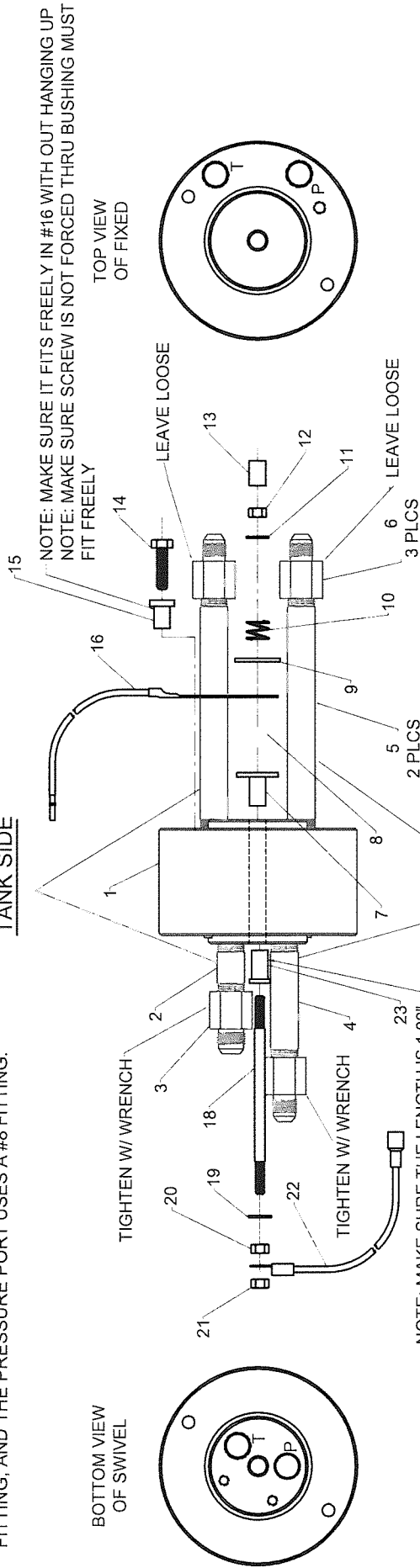

SWIVEL SIDE

FIXED SIDE

PRESSURE SIDE

#	PN	DESCRIPTION	QTY	#	PN	DESCRIPTION	QTY	#	PN	DESCRIPTION	QTY
1	32098	SWIVEL, HYDRAULIC 1/2" PORTS	1	9	32562	WASHER, FLAT 0.50 SS GRADE 304	1	17	30674	BOOT, RUBBER 1 & 1/0	1
2	31996	ADAPTER, NIPPLE 2.50" LG #8	1	10	31452	SPRING, SWIVEL	1	18	32277	STUD, 5/16-18 X 6 DOUBLE END	1
3	32468	ADAPTER, 8FP-10MJ	1	11	32368	WASHER, FLAT 0.37 SAE SS GR304	1	19	33353	WASHER, FLAT 0.31 SAE SS304	1
4	32321	ADAPTER, NIPPLE 4.00" LG #8	1	12	34256	NUT, HEX NYLOC 0.31-18 SS 304	1	20	34255	NUT, HEX 0.31-18 SS 304	1
5	32131	ADAPTER, NIPPLE 8.00" LG #8	2	13	32279	SLEEVE, SWIVEL SCREW INSULATOR	1	21	34256	NUT, HEX NYLOC 0.31-18 SS 304	1
6	31995	ADAPTER, 8FP-8MJ	3	14	23063	SCREW, HHC 0.37-16 X 1.25 GR8	1	22	32278	WIRE, SWIVEL SUPPLY W/TERMINAL	1
7	31382	SPACER, SWIVEL STUD INSULATOR	1	15	31451	INSULATOR, BOLT ELECTRIC	1	23	31383	SPACER, SWIVEL STUD INSULATOR	1
8	31381	SPACER, SWIVEL UPPER - BRONZE	1	16	20500	WIRE, SWIVEL HOT PLATE ASSY D	1				



Houston TX
(713)-688-5533
www.iftmoore.com

DRWN BY: KSP
DATE: 3/23/09

SWIVEL, HYD/ELEC ASSY DTCH
1/2" PORTS, DEUTSCH CONNECTOR

DRAWING NO.
20498-E

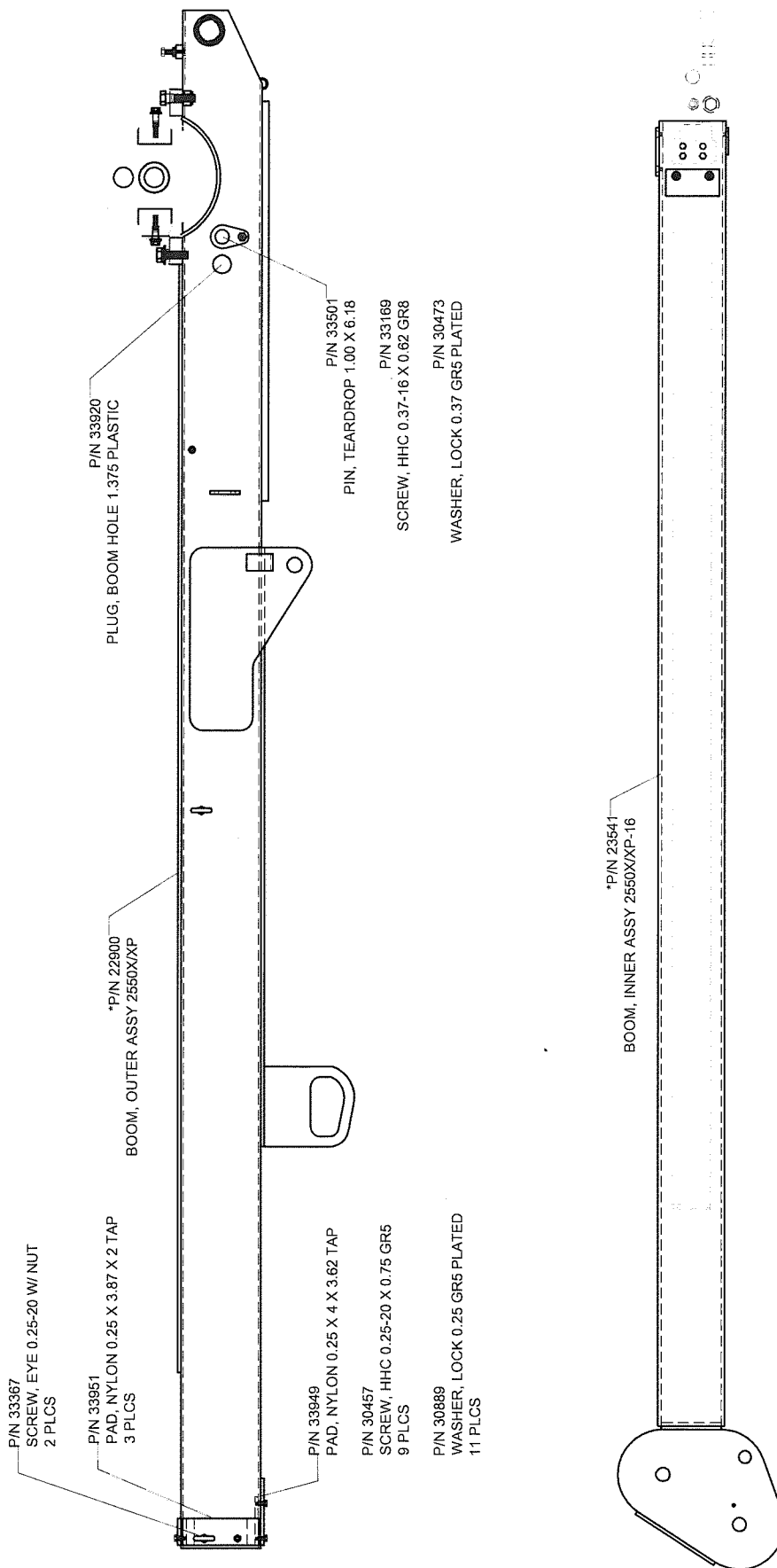

ITEMS WITH * HAVE DETAIL DRAWINGS

DRWN BY: JC
DATE: 02/26/10

Houston TX
(713)-688-5533
www.liftmoore.com



BOOM ASSEMBLY 2550XXP-16
ATB ON LEFT SIDE

DRAWING NO.

23542-0

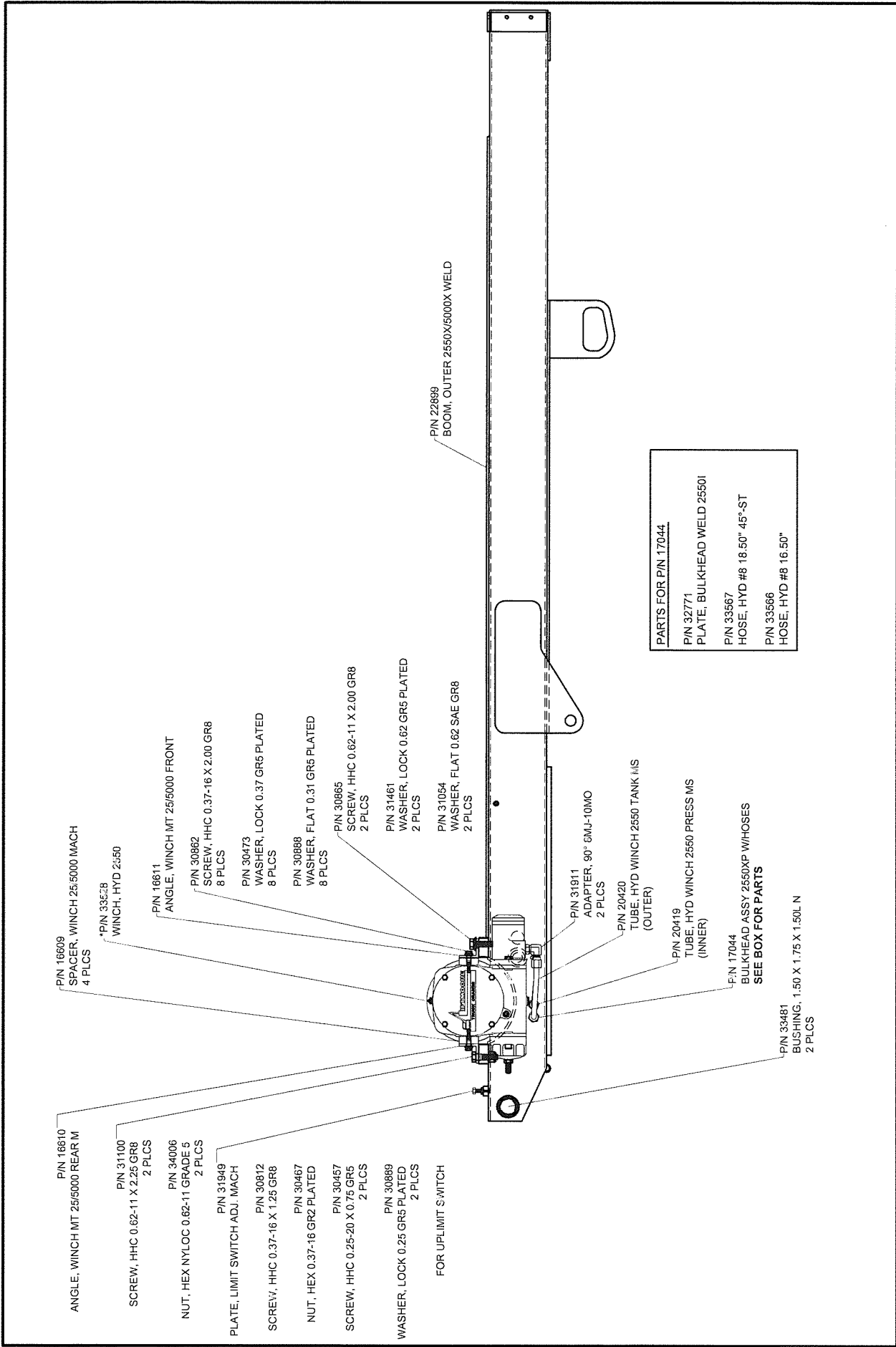

PARTS FOR P/N 17044
 P/N 32771
 PLATE, BULKHEAD WELD 2550I
 P/N 33567
 HOSE, HYD #8 18.50" 45°-ST
 P/N 33566
 HOSE, HYD #8 16.50"

	Houston TX (713)-688-5533 www.liftmoore.com	DRWN BY: JC DATE: 12/15/08	BOOM, OUTER ASSY 2550X/XP-16 & 20 W/ATB ON LEFT SIDE	DRAWING NO. 22900-0
--	---	-------------------------------	---	-------------------------------

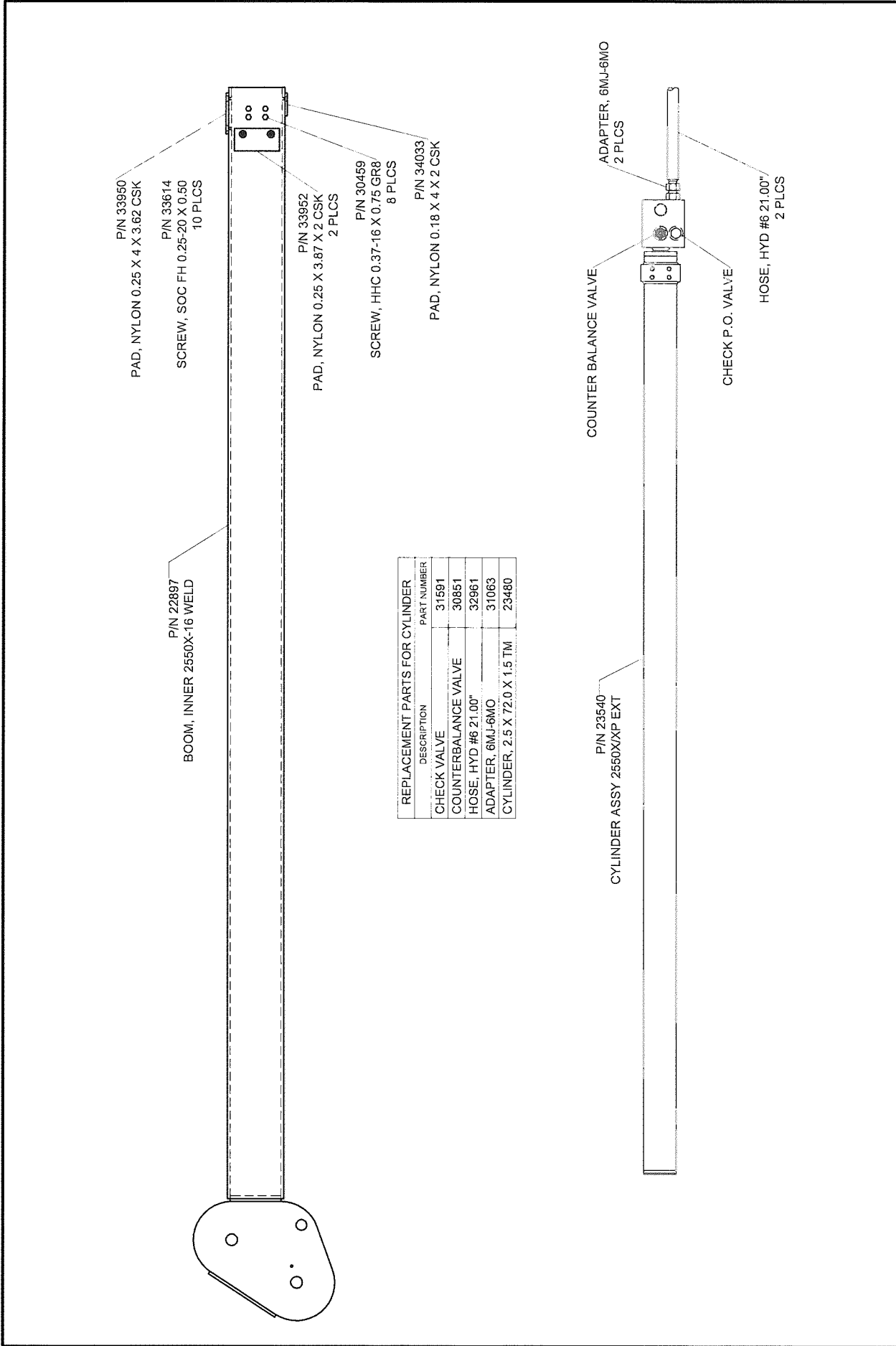

REPLACEMENT PARTS FOR CYLINDER

DESCRIPTION	PART NUMBER
CHECK VALVE	31591
COUNTERBALANCE VALVE	30851
HOSE, HYD #6 21.00"	32961
ADAPTER, 6MJ-6MO	31063
CYLINDER, 2.5 X 72.0 X 1.5 TM	23480

Houston TX
(713)-688-5533
www.liftmoore.com

LIFTMOORE
TRUCK CRANES

DRWN BY: JC
DATE: 02/26/10

BOOM, INNER ASSY 2550X/XP-16
ATB ON LEFT SIDE; W/B.M. CYL.

DRAWING NO. **23541-0**

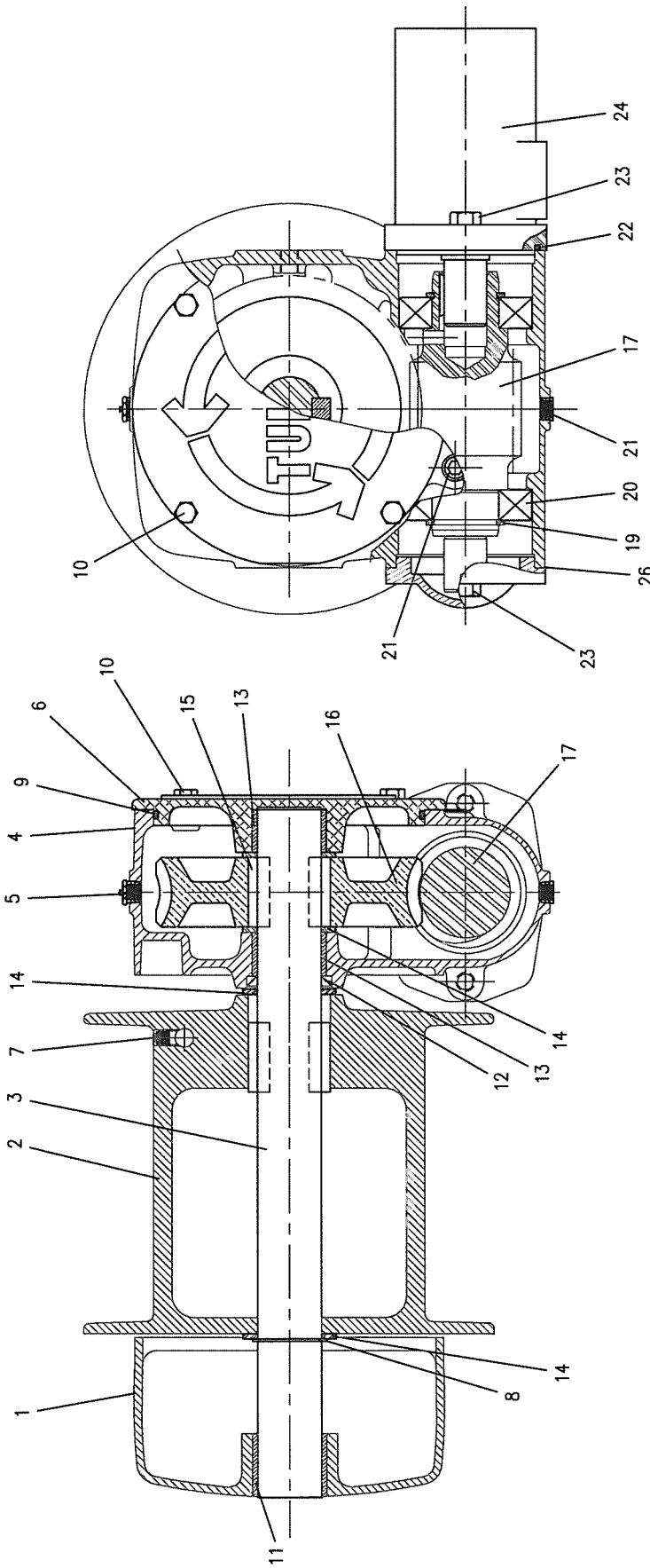

ITEMS WITH * HAVE DETAIL DRAWINGS

#	PN	DESCRIPTION	QTY	#	PN	DESCRIPTION	QTY	#	PN	DESCRIPTION	QTY
1	TW*42423	END BRACKET, MACH	1	10	TW*40407	CAPSCREW	4	19	TW*40396	RING, RETAINING	2
2	TW*41580	DRUM	1	11	TW*40399	BUSHING	1	20	TW*40395	BEARING	2
3	TW*41922	SHAFT, OUTPUT	1	12	TW*40401	SEAL OIL	1	21	TW*32220	PLUG, PIPE	2
4	TW*40383	HOUSING	1	13	TW*40400	BUSHING	2	22	TW*32566	O-RING	1
5	TW*4101	BREATHER KIT	1	14	TW*29017	WASHER	4	23	TW*40410	CAPSCREW	2
6	TW*40391	COVER, MACH	1	15	TW*40518	KEY	4	24	TW*40120	MOTOR, HYDRAULIC	1
7	TW*23582	SCREW-SET	1	16	TW*40618	GEAR, SR	1	25	TW*4034	KIT, BRAKE, OIL	1
8	TW*27240	RETAINING RING	1	17	TW*40598	WORM, SR	1	26	TW*40147	GASKET	1
9	TW*40547	O-RING	1	18	OMIT	OMIT					

Houston TX
 (713)-688-5533
 www.iftmoore.com



WINCH, HYD. 2550

DRAWING NO.

33528-0

TO SET WINCH BRAKE:

- HOLD SCREW 8
- LOOSEN LOCKNUT, 9
- TURN SCREW 8 CW 1/4 TURN
- CHECK FOR DRIFT
- IF BRAKE DOES NOT HOLD, TURN SCREW 8 CW IN 1/4 TURN INCREMENTS UNTIL IT HOLDS
- TIGHTEN JAMNUT, 9, WHEN FINISHED
- DO NOT TIGHTEN MORE THAN NECESSARY. OVER TIGHTNING WILL CAUSE OVER HEATING AND PREMATURE WEAR IN THE BRAKE

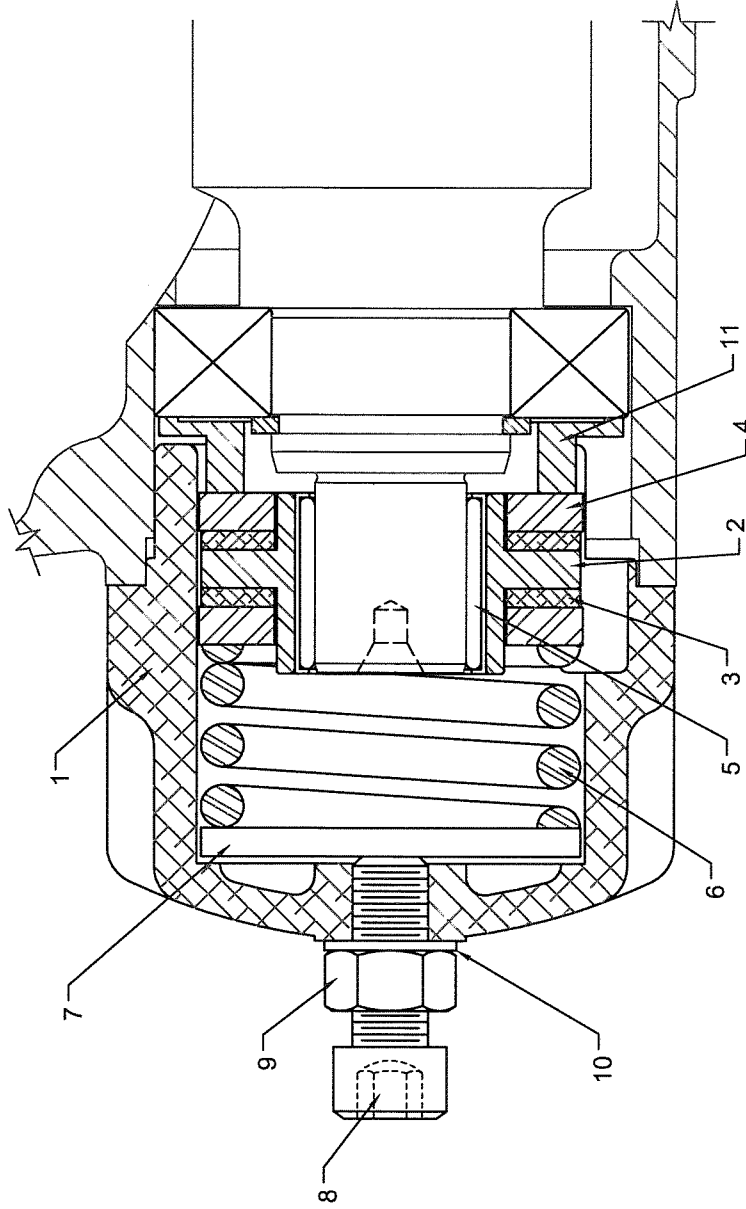

ITEM 12 NOT SHOWN

#	PN	DESCRIPTION	QTY	#	PN	DESCRIPTION	QTY	#	PN	DESCRIPTION	QTY
1	TW*40069	HOUSING	1	5	TW*40113	CAM CLUTCH	1	9	TW*40774	NUT	1
2	TW*40617	HUB	1	6	TW*40077	SPRING	1	10	TW*29044	WASHER	1
3	TW*40075	FRICITION DISC	2	7	TW*40078	TRUST WASHER	1	11	TW*40599	SPACER	1
4	TW*40076	STATOR PLATE	2	8	TW*40775	SET SCREW	1	12	TW*40546	CAPSCREW	2

	Houston TX (713)-688-5533 www.liftmoore.com	DRWN BY: SSC DATE: 11/14/94	WINCH BRAKE PARTS TW*4034 DRAWING NO. 50231-B

CIRCUIT NUMBER AND DESCRIPTION		Function
Wire Color	Wire Length	Connections
BLU/BLK	30"	J14-A
YEL	22"	J14-B
WHT	12"	J14-E
RED	32"	J14-F
GRN	18"	J14-G
ORN	18"	J14-H
BLU	18"	J14-I
WHT/BLK	16"	J14-J
RED/BLK	32"	J14-L
GRN/BLK	16"	J14-M
ORN/BLK	28"	J14-N
BLK	26"	J14-P
BRN	26"	P12A.1
YEL/BLK	26"	P12A.3
GRY	18"	P12A.4
BLK	18"	P12A.5
WHT	34"	P12A.9
YEL	36"	P12A.10
PUR	32"	P12A.11
YEL	N/A	P6.1 MAIN PWR
RED	18"	P6.2
RED	14"	P6.4
RED	14"	P6.5
GRN	24"	P2-U.2
BRN	20"	P12B.1
BRN	20"	P12B.2
BRN	20"	P12B.3
BRN	24"	P12B.4
BRN	24"	P12B.5
BRN	22"	P12B.6
BRN	22"	P12B.7
BRN	26"	P12B.8
BRN	26"	P12B.9
BRN	14"	P12B.10
BRN	38"	P12B.11

NOTE A:
FOR J-14
INSTALL 16GA. WHT PLUGS AT
PIN LOCATIONS: J14-C, D, P6.6 &
P12-B.12

PIN 19917
CONNECTOR DTCH 1P RECEPT
P6-PWR
P/N 19857
CONNECTOR, DTCH 6P
RECEPT BUSS
P/N 19849
CONNECTOR, DTCH
6P PLUG
P2-ATB
ATB
P2-PS
PRESS. SW.
P/N 19921
FUSE HOLDER, ATO 16 GA SEALED
W/ P/N 18456
FUSE, 15 AMP BLADE

J14 -
P/N 18751
SOCKET, 14 PIN DEUTSCH
SEE NOTE A

PIN 22893
PLATE, CONTROL
SOCKET DTCH

NOTCH UP
P/N 15566
TERMINAL, P.O. FEMALE 14-16 GA
2PLCS

P12A-GRY
P/N 19907
CONNECTOR, DTCH DTM 12P-A
PLUG

TR-2
GRND

TR-1 TRIG GRND
P/N 15871
TERMINAL RING
14-16 GA 0.31
3 PLCS

P12B-BLACK
P/N 19655
CONNECTOR, DTCH DTM
12P-6 PLUG
SEE NOTE C

TR-2 MAIN GND
P/N 15871
TERMINAL RING
14-16 GA 0.31

P2-U UP LIMITER
P/N 19847
CONNECTOR, DTCH
2P PLUG
8 PLCS

P2-LA ELEV DN
P2-L ELEV UP
P2-RA ROT CCW
P2-R ROT CW

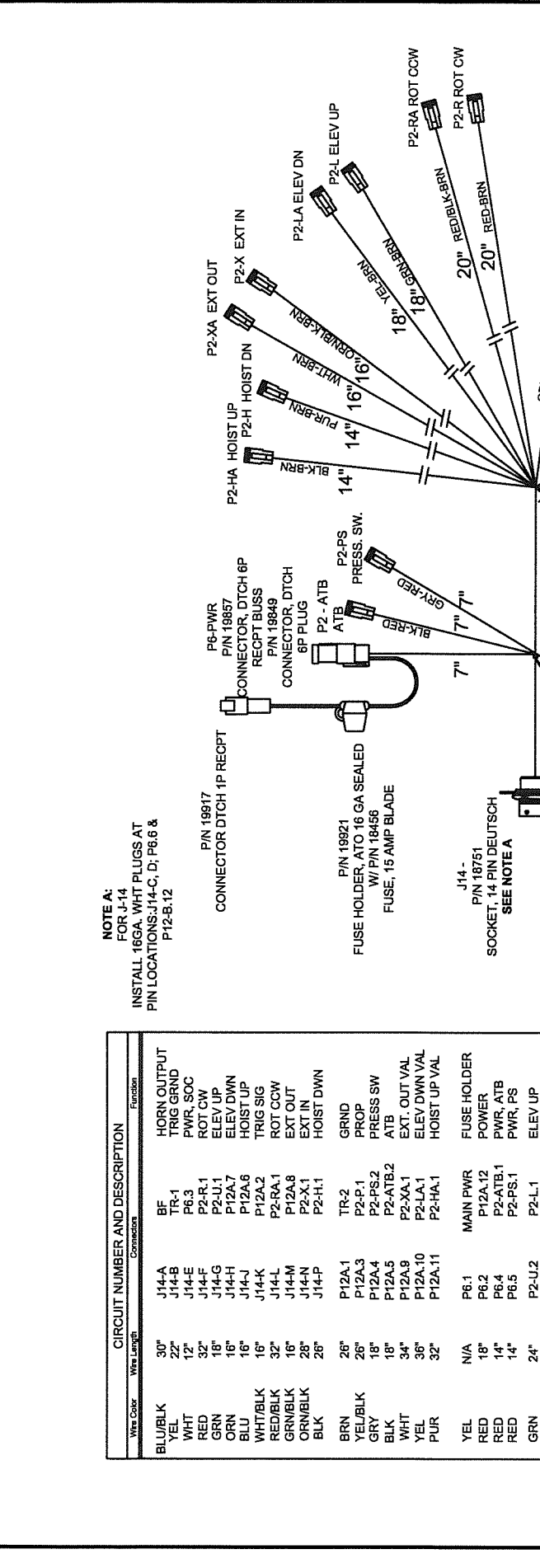

DRAWING NO.
25125-0

EWB, DTCH HYD XP, HALL EFFECT
2550, 3660, 5080

DRWN BY: JE
DATE: 9/11/12

Houston TX
(713)-688-5533
www.liftmoore.com



THIS SCHEMATIC IS USED FOR EWH 25125.

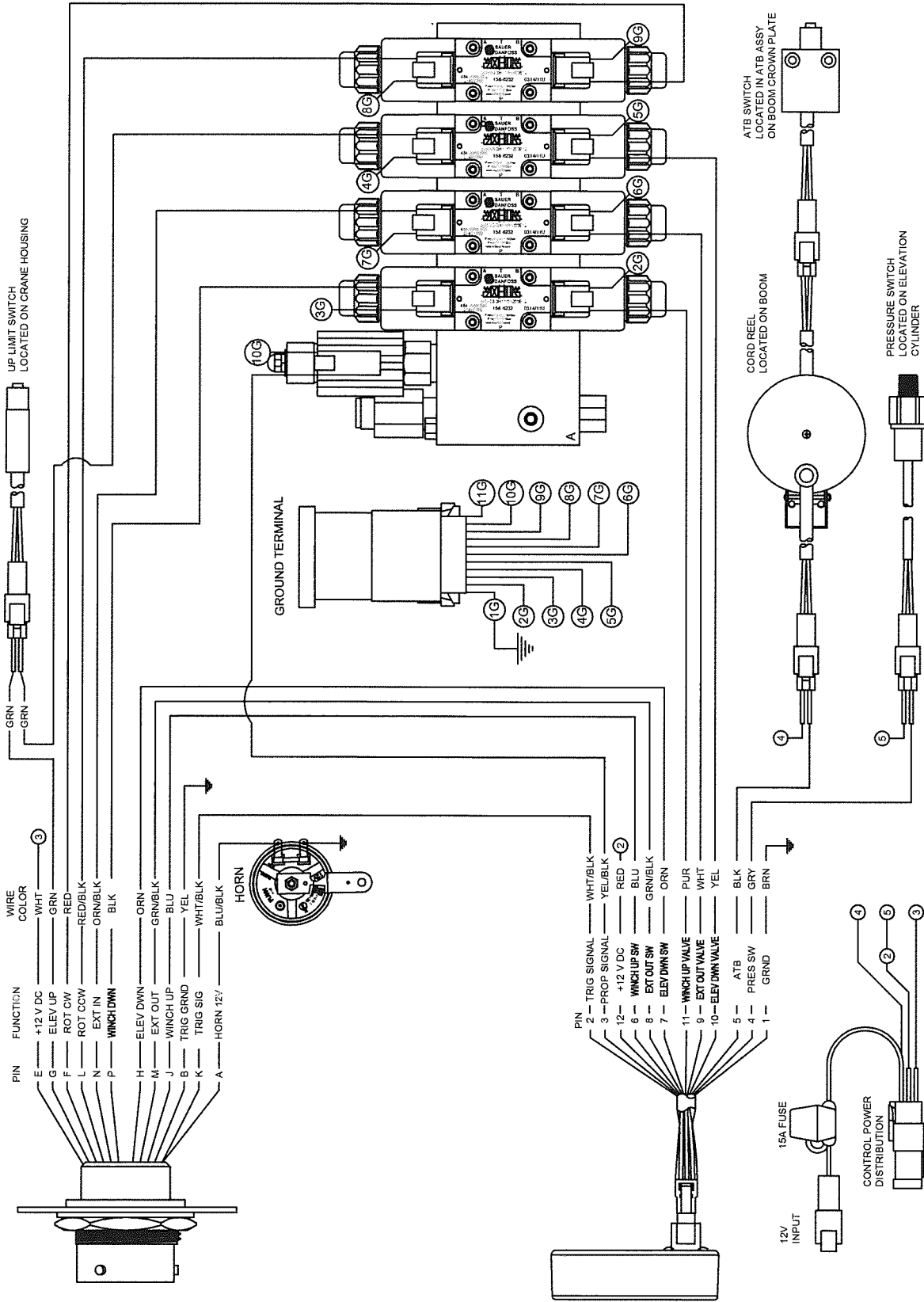



 Houston TX
 (713)-688-5533
 www.iftmoore.com

DRAWN BY: JE
 DATE: 9/10/12

SCHEM, ELEC WIRING DTCH 3RD G XP ATB-BD
 EWH 25125, HALL EFFECT, SD VAL

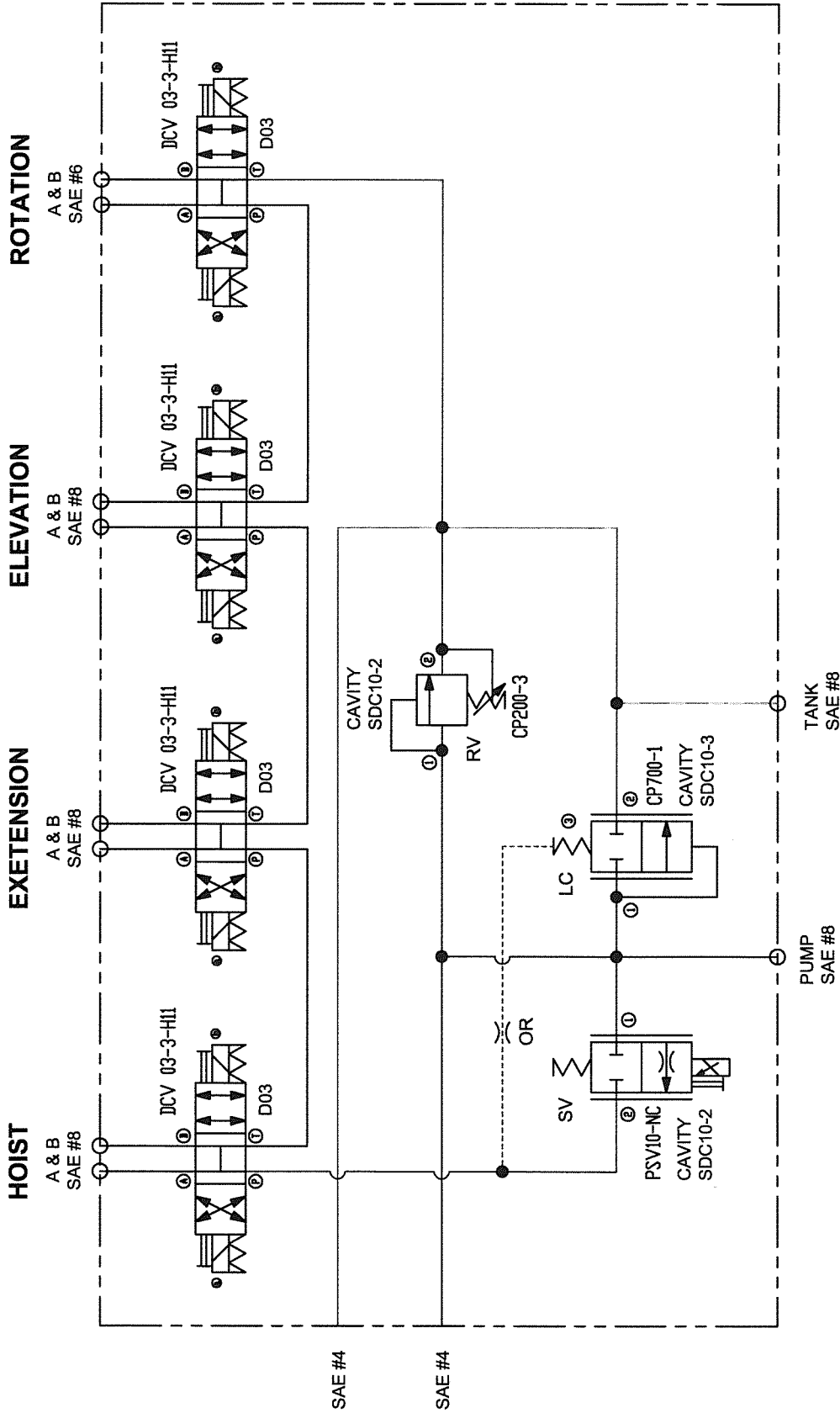
DRAWING NO. 50826-0



NOTE: HYDRAULIC SYSTEM RELIEF PRESSURE SET AT 2800 PSI.
FLOW RATE INTO CRANE SHOULD BE SET AT 6 GPM.

DRAWING NO.
50801-A

SCHEM, HYD PROPORTIONAL
LIFTMOORE-MANIFOLD 24541

DRWN BY: JE
DATE: 6/29/11

Houston TX
(713)-688-5533
www.liftmoore.com



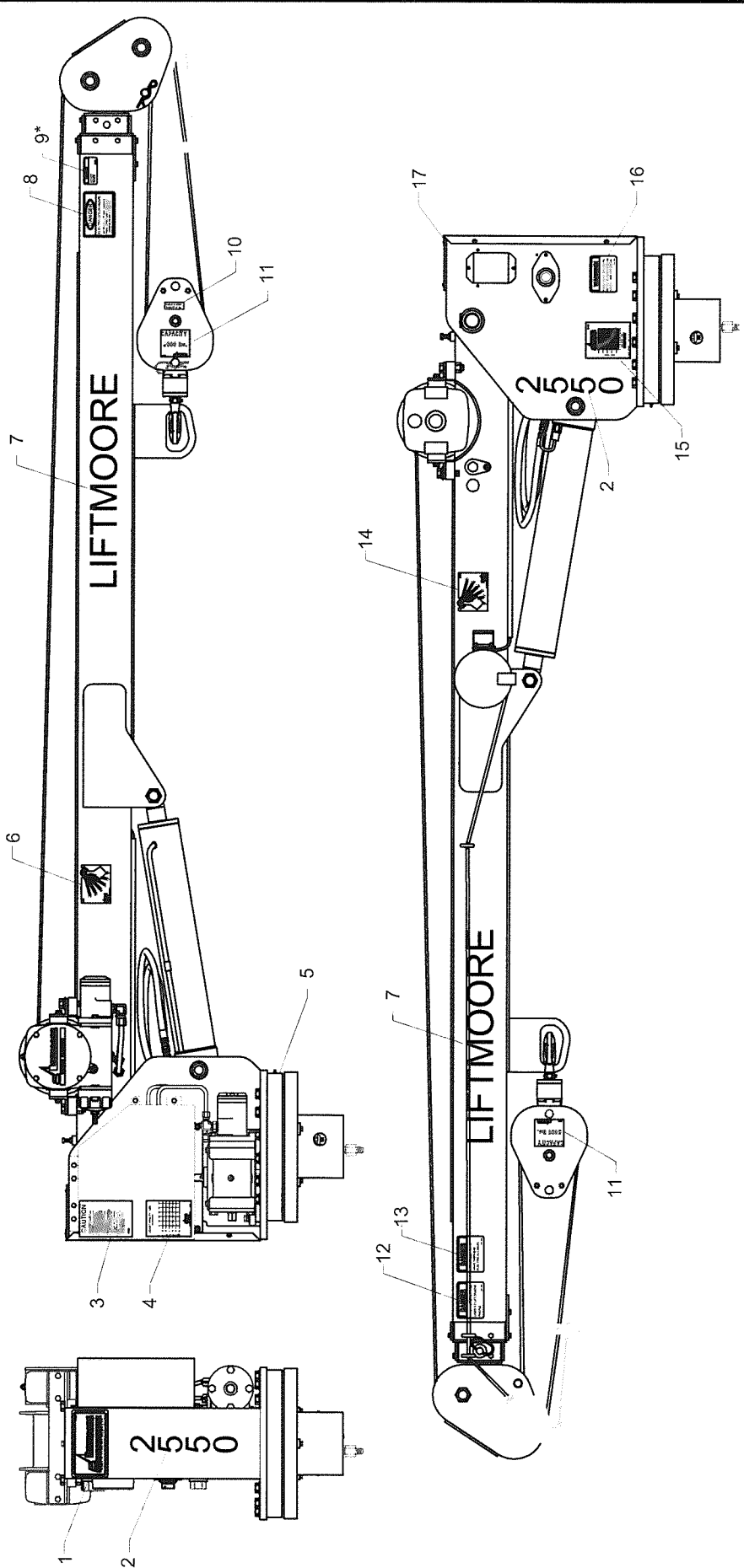

*APPLIES TO 20 FT CRANES

#	PN	DESCRIPTION	QTY	#	PN	DESCRIPTION	QTY	#	PN	DESCRIPTION	QTY
1	15581	DECAL, LOGO LARGE	1	7	15580	DECAL, LIFTMOORE - 3.00"	2	13	15579	DECAL, DANGER CABLES	1
2	15757	DECAL, 2550	2	8	15618	DECAL, DANGER ELECTRIC INJURY	1	14	22375	DECAL, ANGLE PENDULUM LEFT	1
3	16102	DECAL, CAUTION READ MANUAL	1	9	15612	DECAL, CAUTION PIN MUST BE IN	1	15	19020	PLATE, SERIAL 5000W/2-PRT LINE	1
4	22379	DECAL, LOAD CAPACITY 25K-10-20	1	10	22816	DECAL, BLOCK & HOOK WT. 45 lbs.	1	16	15615	DECAL, WARNING TRAVELING BLOCK	1
5	19756	DECAL, ATTENTION GREASE GEAR	1	11	32817	DECAL, TRAVEL BLOCK 5000 LBS.	2	17	23389	PLATE, SERIAL NO. MACH	1
6	22376	DECAL, ANGLE PENDULUM RIGHT	1	12	32085	DECAL, LIFTING PERSONNEL	1				

	Houston TX (713)-688-5533 www.liftmoore.com	DECAL DIAGRAM FOR THE 2550X & XP W/ ATB ON LEFT SIDE	DRAWING NO. 58322-B
	DRWN BY: JC DATE: 11/23/09		

THIS PAGE INTENTIONALLY LEFT BLANK



HOUSTON, TEXAS
FAX: (800) 824-5559 (USA & Canada)
FAX: (713) 688-6324
PHONE: (713) 688-5533
www.liftmoore.com

LIFTMOORE LIMITED WARRANTY

Parts and Structural

Liftmoore, Inc. warrants each LIFTMOORE crane to be free from defects in materials and workmanship for twelve (12) months from the date of delivery to the original customer. Under the terms of this warranty the crane structural components manufactured by LIFTMOORE, Inc. are warranted for thirty-six (36) months from the date of delivery to the original customer. LIFTMOORE, Inc. will repair or replace, as its sole discretion, any equipment or part that is returned f.o.b. to LIFTMOORE, Inc.'s plant at 7810 Pinemont Drive, Houston, Texas 77040, or to one of its authorized dealers, and is found by LIFTMOORE, Inc. or its authorized dealer to have been defective at the time of original delivery.

The foregoing warranty is the exclusive warranty made by LIFTMOORE, Inc. with respect to its cranes and is in lieu of all other warranties. ANY AND ALL OTHER WARRANTIES, EXPRESS OR IMPLIED, INCLUDING ANY WARRANTY OF MERCHANTABILITY OR FITNESS OF ANY CRANE FOR A PARTICULAR PURPOSE OR OPERATION, ARE HERBY EXPRESSLY DISCLAIMED.

The foregoing warranty applies only to LIFTMOORE cranes under normal use and service and does not apply in the event of damage caused by repair or alteration or damage during shipment, accident, negligence, overloading, or misuse, including operator's failure to follow any of the instructions issued with the crane.

This warranty is limited to the original purchaser and is not assignable. In order to submit a claim, the original purchaser must provide a copy of the original invoice for the crane in question within twelve (12) months following the delivery date and within 30 days from the date of repair.

The warranty applies only when the LIFTMOORE crane is used for commercial purposes and does not cover any purchase for use for personal, family or household purposes.

LIMITATION OF LIABILITY: LIFTMOORE, Inc.'s liability for any losses or damages resulting from any cause whatsoever, including LIFTMOORE, Inc.'s NEGLIGENCE or from a defective crane irrespective of whether such defects are discoverable or latent, shall in no event exceed the purchase price of the crane to which losses or damages are claimed, or at the election of LIFTMOORE, Inc., the repair or replacement of the defective crane.

In no event shall LIFTMOORE, Inc. be liable for any special, incidental, or consequential damages, including commercial losses or costs of any kind sustained by purchaser or any other person or for any damages for which purchaser may be liable to other persons by reason of any defect in any LIFTMOORE crane or any part thereof.

LIFTMOORE, Inc. reserves the right to make changes in design or construction of its cranes at any time without obligating itself to make such changes on cranes previously manufactured.

No agent, employee, or representative of LIFTMOORE, Inc. has authority to amend or modify the foregoing warranty or to bind LIFTMOORE, Inc. by any other warranty, guaranty, or assumption of liability.

In the event any provision of this warranty is for any reason held ineffective, the remaining provisions shall remain in full force and effect.

Some states do not allow limitations on how long an implied warranty lasts or the exclusion or limitation of incidental or consequential damages, so the above limitations and exclusions may not apply to you. This warranty gives you specific legal rights, and you may also have other legal rights that vary from state to state.

