

TABLE OF CONTENTS

USERS MANUAL P/N 24006

206EL W

SECTION I

GENERAL OPERATION, INSPECTION, AND MAINTENANCE

CRANE SAFETY RULES	F1122-B	1-1
INTRODUCTION	F1111-D	1-3
OPERATING RESTRICTIONS	F1449-0	1-4
OPERATING PRACTICES	F1449-0	1-4
INSPECTION AND MAINTENANCE.....	F1113-C	1-7
MONTHLY INSPECTION REPORT.....	F1448-0	1-9
STANDARD HAND SIGNALS FOR CRANE OPERATIONS ..	F2409-0	1-10

SECTION II

CRANE SYSTEMS AND TROUBLESHOOTING

PENDANT CONTROL	F1276-0	2-1
SAFETY SYSTEM.....	F1276-0	2-1
ELECTRIC HOIST.....	F1239-0	2-2
HYDRAULIC SYSTEM	F1249-A	2-3
MANUAL FUNCTIONS.....	F1248-0	2-4
TROUBLESHOOTING ELECTRIC HOIST	F1243-A	2-5
TROUBLESHOOTING HYDRAULIC SYSTEM.....	F1250-A	2-7

SECTION III

CRANE SPECIFICATIONS

LIFTING CAPACITIES	F1451-C	3-1
POWER FUNCTIONS AND SPEEDS	F1451-C	3-1
LIFTING CAPACITIES - 206W	F1451-C	3-2
POWER FUNCTIONS AND SPEEDS - 206W	F1451-C	3-2
BOLT AND LUBRICATION SPECS.....	F1451-C	3-3

SECTION IV

PARTS

BOX PARTS LIST.....	F1748-C	4-1
CRANE ASSEMBLY	DWG.24005-A	4-2
PENDANT CONTROL.....	DWG.17216-B	4-3
BOOM-BODY ASSEMBLY	DWG.24004-0	4-4
ELEVATION CYLINDER ASSEMBLY	DWG.20627-A	4-5
BODY ASSEMBLY	DWG.22345-B	4-6
HYDRAULIC PUMP.....	DWG.17087-C	4-7
BASE-HOUSING ASSEMBLY	DWG.22344-D	4-8
BOOM ASSEMBLY – 206W	DWG.23885-0	4-9
WINCH DRAWING	DWG.23872-C	4-10
WINCH PARTS	DWG.23872-C	4-11
ELECTRICAL SCHEMATIC.....	DWG.50527-B	4-12
DECAL DIAGRAM	DWG.58414-0	4-13



F1747-G
0428/16

HOUSTON, TEXAS
FAX: (800) 824-5559 (USA & Canada)
FAX: (713) 688-6324
PHONE: (713) 688-5533
www.liftmoore.com

TABLE OF CONTENTS

USERS MANUAL P/N 24006
206EL W

WARRANTYF1442-A



F1747-G
0428/16

HOUSTON, TEXAS
FAX: (800) 824-5559 (USA & Canada)
FAX: (713) 688-6324
PHONE: (713) 688-5533
www.liftmoore.com

CRANE SAFETY RULES

CAUTION!

1. READ AND UNDERSTAND OPERATOR'S MANUAL.
2. INSPECT VEHICLE AND CRANE, INCLUDING ITS OPERATION, BEFORE DAILY USE.
3. USE THIS EQUIPMENT ONLY ON SOLID LEVEL GROUND WITH OUTRIGGERS OR JACKSTANDS PROPERLY SET.
4. BEFORE OPERATING THE CRANE REFER TO MAXIMUM LOAD CHART ON CRANE FOR OPERATING LOAD LIMITS.
5. BE SURE LOAD BEING LIFTED IS WITHIN SAFE WINCH CAPACITY AS WELL AS SAFE CRANE CAPACITY. MULTI-PART LINE OPERATION IS REQUIRED WHEN SINGLE LINE LOAD CAPACITY OF WINCH IS EXCEEDED.
6. DO NOT OPERATE, WALK, OR STAND UNDER THE BOOM OR ANY SUSPENDED LOAD.
7. ALWAYS PAY OUT LOAD LINE BEFORE EXTENDING BOOM. WIRE ROPE DAMAGE AND / OR BREAKAGE MAY OCCUR.
8. BOOM MUST BE IN ITS REST BEFORE MOVING VEHICLE.
9. BOOM TIP MUST BE DIRECTLY OVER THE LOAD BEFORE ANY LIFTING IS STARTED. DO NOT DRAG LOADS WITH THIS CRANE.
10. MAINTAIN THIS CRANE AS REQUIRED IN THE OWNER'S MANUAL.
11. DO NOT ALLOW PERSONNEL TO RIDE ON THE LOAD LINE, LOAD, OR BOOM OF THIS CRANE.
12. IT IS UNLAWFUL TO OPERATE THIS EQUIPMENT WITHIN TEN FEET OF HIGH VOLTAGE LINE



THIS PAGE INTENTIONALLY LEFT BLANK



F1122-B
05/12/08

HOUSTON, TEXAS
FAX: (800) 824-5559 (USA & Canada)
FAX: (713) 688-6324
PHONE: (713) 688-5533
www.liftmoore.com

INTRODUCTION

This crane is a powerful machine designed to lift and move heavy loads. There are many hazards associated with these operations. Liftmoore has designed this crane to be as safe as possible but -

IT IS THE OPERATOR'S RESPONSIBILITY TO PREVENT ACCIDENTS!

This takes pre-planning, attention, and knowledge of basic principles and rules. Even if you have used similar cranes, reading this manual in its entirety will help prevent damage, injury, or even loss of life; benefits well worth the short amount of time it takes to read these pages.

REGULATORY AUTHORITY

Use of this crane is governed by OSHA 29 CFR 1910.180 and may be governed by other federal, state, or local regulations.

IT IS THE OPERATOR'S RESPONSIBILITY TO UNDERSTAND AND COMPLY WITH ALL APPLICABLE REGULATIONS GOVERNING THE OPERATION, INSPECTION, AND MAINTENANCE OF THIS CRANE.

Personnel should be trained, tested, and certified, as recommended by OSHA and ANSI standards, before operating this crane.

USING THIS MANUAL

This manual assumes that the crane is mounted on a typical service body type or similar truck, which is powered by the vehicle electrical or hydraulic system, and is controlled by either the standard pendant control or FM radio control sold by Liftmoore, Inc.

This manual is supplied to provide basic guidelines for the safe use, routine maintenance, and general inspections of this crane.

Laws, regulations, standards, or policies may be more restrictive than this manual. If a conflict exists for any limit or condition, the safest or most prohibitive shall be used. Under no circumstances shall the load, moment, or stability ratings be exceeded.

Pay particular attention to the following:

WARNING! – Draws attention to hazards, conditions, or procedures that if not observed could result in injury or death.

CAUTION! – Draws attention to hazards, conditions, or procedures that if not observed could result in damage to the crane, load, or other equipment. Equipment failure could in turn lead to injury or death.

NOTE! – Draws attention to conditions or procedures that are essential to emphasize.

For questions, interpretations, or to report errors, please contact Liftmoore, Inc, Engineering Dept.



OPERATING RESTRICTIONS

DUTY CYCLE

For Electric Cranes the duty cycle time should be limited to 10%. This is limited by heat buildup in the motors and declining charge in the batteries. (Installing extra batteries near the crane helps keep the voltage at maximum.)

PERSONNEL

LIFTING OR MOVING OF PERSONNEL IS STRICTLY PROHIBITED! This crane was neither designed nor intended to lift personnel. Under no circumstances should anyone be allowed to ride on the crane, line, or load. All non-essential personnel must be kept away when using the crane. The load must never be moved over people, nor must anyone be allowed to pass or stand under a suspended load.

ELECTRICAL LINES

Consult ANSI B30.5 for operating procedures, minimum safe distances, and prohibited zones when working around electrical lines or poles.

When operating near electrical power lines, the crane must be positioned so that the distance from the crane to the lines or poles is equal to or greater than the length of the fully extended boom plus the minimum safe distance required.

All parts of the crane, line, and load must be kept a minimum safe distance from electrical power lines and poles. This distance is 10 feet for electrical lines carrying 50kV or less.

UNDER NO CIRCUMSTANCES SHOULD A CRANE BE OPERATED UNDER ELECTRICAL POWER LINES.

OPERATING PRACTICES

SETUP

POSITION The vehicle must be positioned so that the load is kept as close to the crane base as possible to reduce the moment on the crane. Consideration must be given to starting and ending position as well as firmness and slope of the ground and any obstructions.

OUTRIGGERS The outriggers or jackstands must be firmly set and the vehicle as level as possible. This will reduce the stresses on the rotation drive and keep the load off the vehicle's suspension. Keep in mind that the weight on the vehicle will shift as the crane and load are rotated.

LOAD LIMIT The operator must understand the crane load chart. The operator must ensure that the load is within the load limits over the entire range which it will be moved. Be sure to include the weight of any lifting devices including the travel block.

The load limit chart is attached to the side of the crane to aid the operator.

The boom angle indicator and chart aids the operator in determining the load capacity at various boom angles and extensions. It also gives the load limit at that configuration.

STABILITY The operator is responsible to verify that the truck is stable at any area where the Crane is rotated.

TRAVEL BLOCK The operator must determine if the load is within the single line compatibility of the winch or if a multi-part line configuration is needed.



OPERATING PRACTICES

OPERATING RESTRICTIONS

DUTY CYCLE

For Electric Cranes the duty cycle time should be limited to 10%. This is limited by heat buildup in the motors and declining charge in the batteries. (Installing extra batteries near the crane helps keep the voltage at maximum.)

PERSONNEL

LIFTING OR MOVING OF PERSONNEL IS STRICTLY PROHIBITED! This crane was neither designed nor intended to lift personnel. Under no circumstances should anyone be allowed to ride on the crane, line, or load. All non-essential personnel must be kept away when using the crane. The load must never be moved over people, nor must anyone be allowed to pass or stand under a suspended load.

ELECTRICAL LINES

Consult ANSI B30.5 for operating procedures, minimum safe distances, and prohibited zones when working around electrical lines or poles.

When operating near electrical power lines, the crane must be positioned so that the distance from the crane to the lines or poles is equal to or greater than the length of the fully extended boom plus the minimum safe distance required.

All parts of the crane, line, and load must be kept a minimum safe distance from electrical power lines and poles. This distance is 10 feet for electrical lines carrying 50kV or less.

UNDER NO CIRCUMSTANCES SHOULD A CRANE BE OPERATED UNDER ELECTRICAL POWER LINES.

SETUP

POSITION The vehicle must be positioned so that the load is kept as close to the crane base as possible to reduce the moment on the crane. Consideration must be given to starting and ending position as well as firmness and slope of the ground and any obstructions.

OUTRIGGERS The outriggers or jackstands must be firmly set and the vehicle as level as possible. This will reduce the stresses on the rotation drive and keep the load off the vehicle's suspension. Keep in mind that the weight on the vehicle will shift as the crane and load are rotated.

LOAD LIMIT The operator must understand the crane load chart. The operator must ensure that the load is within the load limits over the entire range which it will be moved. Be sure to include the weight of any lifting devices including the travel block.

The load limit chart is attached to the side of the crane to aid the operator.

The boom angle indicator and chart aids the operator in determining the load capacity at various boom angles and extensions. It also gives the load limit at that configuration.

STABILITY The operator is responsible to verify that the truck is stable at any area where the Crane is rotated.

TRAVEL BLOCK The operator must determine if the load is within the single line compatibility of the winch or if a multi-part line configuration is needed.



HOLDING THE LOAD

The operator must keep the load in sight at all times once it is lifted.

The operator must never leave the controls once the load is lifted.

The operator must ensure that no one is allowed to pass or stand under a suspended load.

CAUTION!

Never move the vehicle with a suspended load. Doing so will put dynamic loads on the crane for which it was not designed.

MOVING THE LOAD

Before moving the load, make sure the path is free of any obstructions or people.

Avoid sudden accelerations or stops. Speeds must be kept to a minimum, especially rotation, to keep the load from swinging.

Avoid sudden reversing of direction. Do not reverse direction while the load is still moving.

Make sure that no part of the crane, boom, or load makes contact with any obstruction or comes within a minimum of ten feet from any electrical line.

TRANSIT

While in transit, the crane must be stowed, preferably in a boom rest. The crane must be prevented from rotating and the hook prevented from swinging.



INSPECTION AND MAINTENANCE

OSHA and ANSI require frequent and periodic inspections. Records of these inspections must be kept readily available. Liftmoore requires periodic maintenance to ensure proper operation and prolonged life of the crane.

INSPECTION

DAILY INSPECTION

OSHA 29CFR 1910.180 (d)(2)(i) requires the following be checked daily prior to use:

- All control mechanisms for maladjustment interfering with proper operation as well as for excessive wear of components and contamination by lubricants or other foreign matter.
- All safety devices for malfunction. This should include the anti-two block and pressure switch.
- Deterioration or leakage in air or hydraulic systems.
- Crane hooks with deformations or cracks. For hooks with cracks or having more than 15 percent in excess of normal throat opening or more than 10 deg. twist from the plane of the unbent hook.
- Electrical apparatus for malfunctioning, signs of excessive deterioration, dirt, and moisture accumulation. This should include the battery terminals, master disconnect switch, electrical swivel
- The wire rope shall be replaced if any of the following conditions are noted:
 - Kinking, crushing, bird-caging, or other damage
 - Reductions from nominal diameter of more than one-sixty-fourth inch for diameters up to and including five-sixteenths inch, one-thirty-second inch for diameters three-eighths inch to and including one-half inch.
 - Thimble is not in place or is damaged
 - Any evidence of heat damage
 - Six or more randomly distributed broken wires in 1 lay
 - Three or more broken wires in 1 strand in 1 lay

MONTHLY INSPECTION

A thorough inspection of all ropes in use shall be made at least once a month and a certification record which includes the date of inspection, the signature of the person who performed the inspection and an identifier for the ropes shall be prepared and kept on file where readily available. All inspections shall be performed by an appointed or authorized person. Any deterioration, resulting in appreciable loss of original strength shall be carefully observed and determination made as to whether further use of the rope would constitute a safety hazard. Some of the conditions that could result in an appreciable loss of strength are the following:

- Reduction of rope diameter below nominal diameter due to loss of core support, internal or external corrosion, or wear of outside wires.
- A number of broken outside wires and the degree of distribution of concentration of such broken wires.
- Worn outside wires.



- Corroded or broken wires at end connections.
- Corroded, cracked, bent, worn, or improperly applied end connections.
- Severe kinking, crushing, cutting, or unstranding.

PERIODIC INSPECTION

An Annual Inspection Form is included in this manual. OSHA 29CFR 1910.180 (d)(2)ii requires periodic inspections of this crane. Liftmoore recommends an annual inspection using the included form.

MAINTENANCE PRECAUTIONS

Before any maintenance is performed, the vehicle should be out of the way and the crane secured.

WARNING!

Never perform any maintenance while the crane has any type of load on it. Use the manual operation procedure to lower the load if necessary.

WARNING!

Hydraulic cylinders may have high pressure stored in them even after hydraulic power is removed.

The counterbalance and pilot operated check valve in the cylinder will always hold some pressure in the cylinder. Slightly extending the cylinder then retracting a small amount will relieve most of the pressure in the cylinder. **DO NOT DEADHEAD THE CYLINDER!** This will store the maximum amount of pressure in the cylinder. Care should be taken when either valve is removed from the cylinder as some pressure will still remain.

After any maintenance has been performed the crane shall not be operated until all guards have been reinstalled, all safety devices reactivated, and maintenance equipment removed.

LUBRICATION Refer to the crane specification section for the periodic maintenance schedule and type of lubrication required.

BOLTS Bolts may loosen over time due to vibration; therefore they should be checked periodically. If bolts need to be replaced, make sure they are replaced with bolts of equal or greater strength. Check the periodic maintenance schedule (Crane Specification Section) for bolt specification and torque.

NOTE!

Sheave and boom and cylinder pivot bolts are not standard bolts. The shank and thread length of these bolts have been modified so that they do not pivot on the threads. Consult the parts section of this manual for part numbers of these bolts.

OTHER MAINTENANCE

Refer to parts drawings for any specific maintenance or adjustment procedures such as hydraulic winch brake, rotation drive gear set adjustment, ect.



MONTHLY INSPECTION REPORT

Manual Boom Extension

Crane Model No. _____ **Serial Number** _____

- Are Boom Hitch Pins and Keepers in place? Yes _____ No _____
- Wire Line Hook with Safety Latch Working? Yes _____ No _____
- Is Hook OK, (Not bent)? Yes _____ No _____
- Is Thimble on Wire Rope OK? Yes _____ No _____
- Does Traveling Block function correctly? Yes _____ No _____
- Is Wire Rope OK, not kinked or frayed? Yes _____ No _____
- Are all Boom Sections straight? Yes _____ No _____
- Are Sheave Bolts in place and tight? Yes _____ No _____
- Do all Sheaves rotate easily? Yes _____ No _____
- Are Mounting Bolts torqued correctly? Yes _____ No _____
- Is Boom Angle Indicator in place and functioning,
and is Chart legible? Yes _____ No _____
- Are Cylinder or Boom Support Mounting Bolts secure? Yes _____ No _____
- Are Winch Mounting Bolts tight? Yes _____ No _____
- When stopped, does winch down drift less than 1.0 Inches? Yes _____ No _____
- Is Load Chart in place and easily read? Yes _____ No _____
- Are functions on Pendant operating correctly? Yes _____ No _____
- Is Hydraulic Reservoir full? Yes _____ No _____
- Is Outrigger or jackstand straight and functioning? Yes _____ No _____

Any items checked 'No' must be repaired before using this crane.



F1448-0
06/07/07

HOUSTON, TEXAS
 FAX: (800) 824-5559 (USA & Canada)
 FAX: (713) 688-6324
 PHONE: (713) 688-5533
 www.liftmoore.com

STANDARD HAND SIGNALS FOR CONTROLLING CRANE OPERATIONS

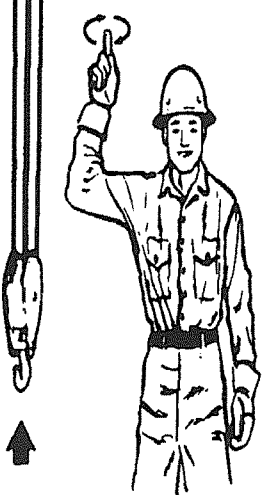
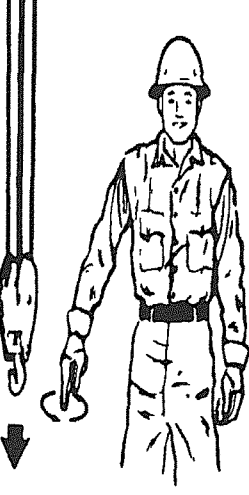
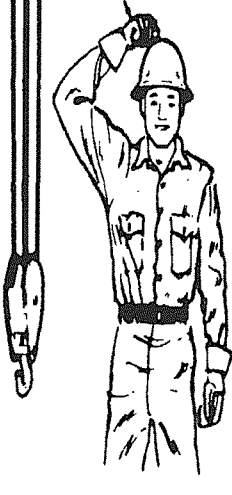
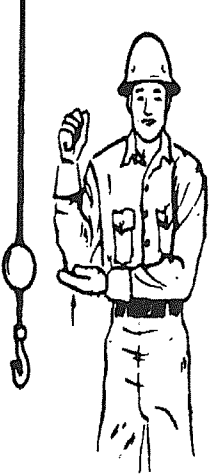
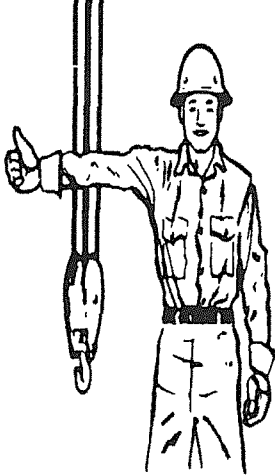
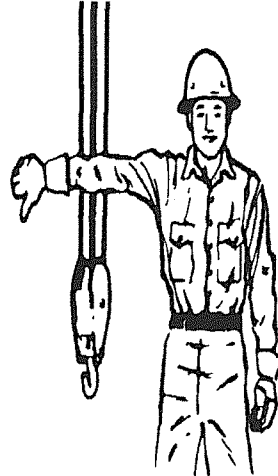
 <p>HOIST. With forearm vertical, forefinger pointing up, move hand in small horizontal circle.</p>	 <p>LOWER. With arm extended downward, forefinger pointing down, move hand in small horizontal circle.</p>	 <p>USE MAIN HOIST. Tap fist on head; then use regular signals.</p>
 <p>USE WHIPLINE (Auxiliary Hoist). Tap elbow with one hand; then use regular signals.</p>	 <p>RAISE BOOM. Arm extended, fingers closed, thumb pointing upward.</p>	 <p>LOWER BOOM. Arm extended, fingers closed, thumb pointing downward.</p>

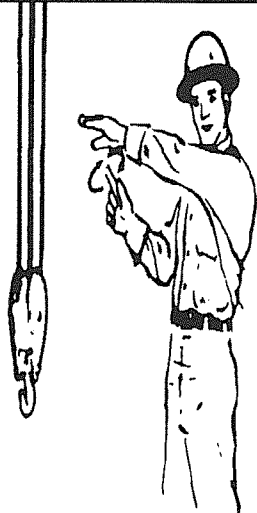
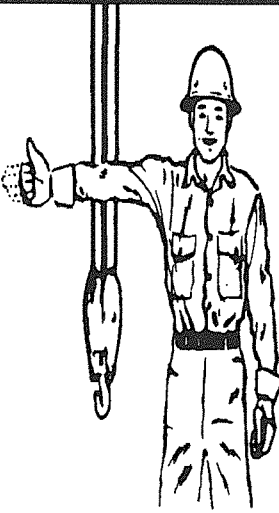
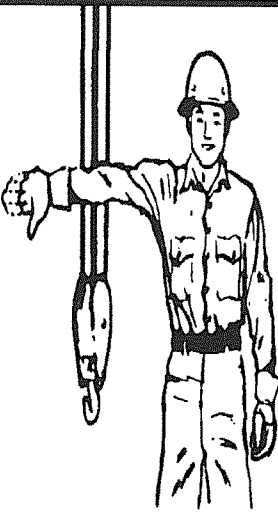
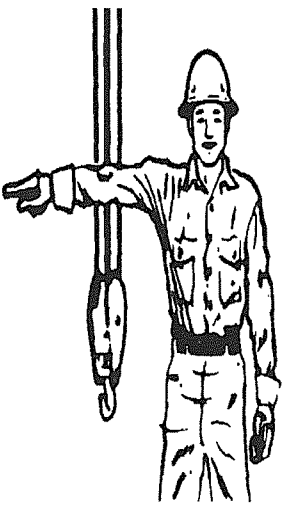
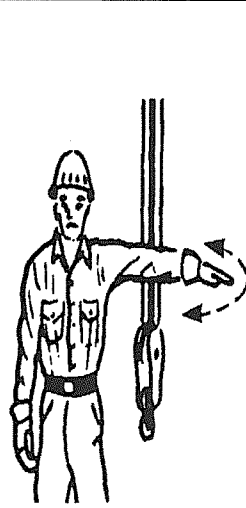
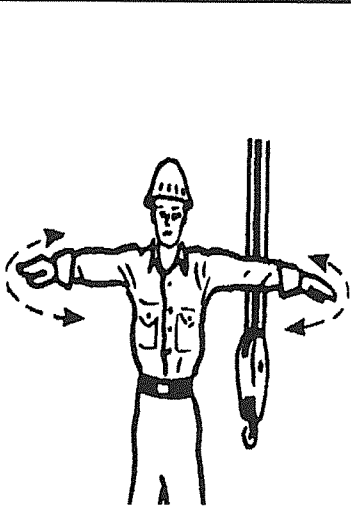
 <p>MOVE SLOWLY. Use one hand to give any motion signal and place other hand motionless in front of hand giving the motion signal. (Hoist slowly shown as example.)</p>	 <p>RAISE THE BOOM AND LOWER THE LOAD. With arm extended, thumb pointing up, flex fingers in and out as long as load movement is desired.</p>	 <p>LOWER THE BOOM AND RAISE THE LOAD. With arm extended, thumb pointing down, flex fingers in and out as long as load movement is desired.</p>
 <p>SWING. Arm extended, point with finger in direction of swing of boom.</p>	 <p>STOP. Arm extended, palm down, move arm back and forth horizontally.</p>	 <p>EMERGENCY STOP. Both arms extended, palms down, move arms back and forth horizontally.</p>

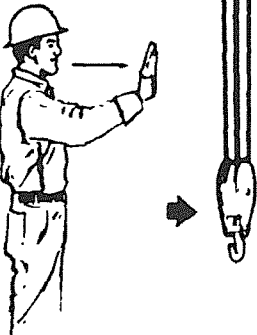
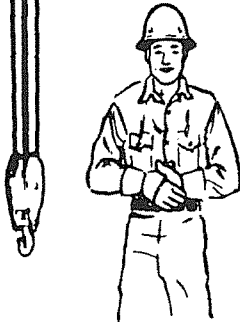
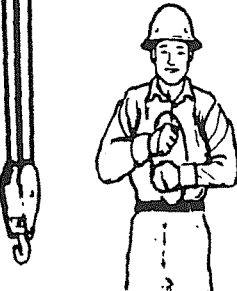
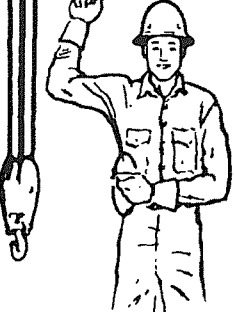
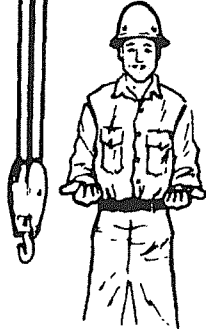
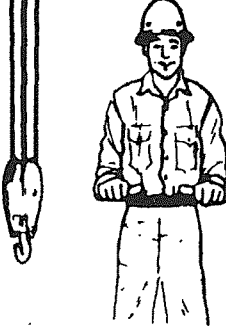
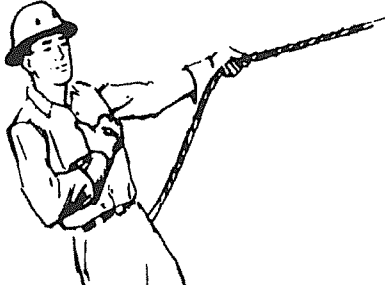
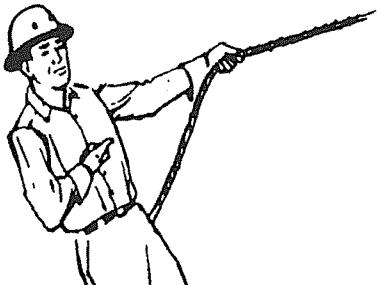
 <p>TRAVEL. Arm extended forward, hand open and slightly raised, make pushing motion in direction of travel.</p>	 <p>DOG EVERYTHING. Clasp hands in front of body.</p>	 <p>TRAVEL (Both Tracks). Use both fists in front of body, making a circular motion about each other, indicating direction of travel, forward or backward. (For land cranes only.)</p>
 <p>TRAVEL. (One Track) Lock the track on side indicated by raised fist. Travel opposite track in direction indicated by circular motion of other fist, rotated vertically in front of body. (For land cranes only.)</p>	 <p>EXTEND BOOM (Telescoping Booms). Both fists in front of body with thumbs pointing outward.</p>	 <p>RETRACT BOOM (Telescoping Booms). Both fists in front of body with thumbs pointing toward each other.</p>
 <p>EXTEND BOOM (Telescoping Boom). One Hand Signal. One fist in front of chest with thumb tapping chest.</p>		 <p>RETRACT BOOM (Telescoping Boom). One Hand Signal. One fist in front of chest, thumb pointing outward and heel of fist tapping chest.</p>

CRANE OPERATION

1 or 2 Powered Functions, LS only

PENDANT CONTROL

All user inputs are facilitated by the remote pendant control. The pendant control plug mates with the crane control socket and controls the hoist and other functions, if applicable, through contactors or solenoids located on the crane.

OPERATION

Raise the cover on the crane control socket and plug in the pendant. Ensure all pins are straight and free of dirt, moisture, and corrosion.

NOTE!

The control socket cover locks the plug in the socket and must be lifted to unplug the pendant.

CARE AND MAINTENANCE

The pendant control is designed to be as rugged and maintenance free as possible; however, care should be used in handling and storage as it is expensive to replace.

Follow these simple practices:

- Keep the pendant out of the weather
- When not in use, store the pendant inside the vehicle
- Do not wrap the wire too tightly as internal damage to the wires may result
- Do not place sharp or heavy objects on the cord

NOTE!

The pendant is designed to be weatherproof not waterproof. It may be used in inclement weather, but if left outside or where water can puddle, water can seep inside.

Maintenance should be limited to routine inspection of the plug, wire, and fasteners.

ELECTRICAL SYSTEM

This crane is powered by the vehicle electric system. Electrical power is connected at the crane by a single pole Mecon brand or similar type electrical connector. On L Series, 206M, and 2000A model cranes the power is connected directly to the crane housing.

On 206R cranes the connection is made at the base and is transferred to the housing through an electrical swivel. The swivel allows for continuous, unlimited rotation of the crane.

NOTE!

The vehicle battery **MUST** be rated at 90 Amp/Hour minimum. It is highly recommended that a second battery, wired in parallel with the vehicle battery, be placed as close to the crane as possible. Deep cycle batteries should be used.

CIRCUIT BREAKER

A circuit breaker is supplied with the crane and should be installed as close to the battery as possible.

DISCONNECT SWITCH

A power disconnect switch is supplied with the crane. Disconnecting the power will prevent inadvertent or unauthorized use and help prevent corrosion at electrical connections.

SAFETY SYSTEM

This crane does not have an ATB safety system.

The operator must always be aware of the hook and travel block position and ensure that the crane is never two-blocked (allowing the travel block or hook to contact the crown plate.)

A pressure switch in the elevation cylinder acts as a load limiting device. See the hydraulic section from more information.



ELECTRIC HOIST

Permanent Magnet Motor

This Liftmoore crane features an electrically driven planetary gear hoist. The hoist is powered in both directions and features an automatic internal brake to positively control the load.

The hoist is permanently lubricated at the factory. Barring damage or part replacement, no further lubrication is necessary.

MOTOR

The hoist motor is a permanent magnet, reversible, direct current (DC) motor.

CAUTION!

The hoist motor is rated for intermittent duty. Duty cycle is limited to 5 minutes in 30 to allow the motor to cool. Extended use can damage the motor.

CAUTION!

When the motor approaches stall, a very rapid heat build up occurs which can cause permanent motor damage. Discontinue use when the motor speed is reduced excessively by voltage drop or load.

BRAKE

The hoist features a single acting, overrunning brake. It automatically activates to hold the load and assist in lowering the load.

WARNING!

The hoist brake only functions in one direction. If the hoisting direction is reversed by reversing the rope winding direction the brake will not hold and the load will fall. Serious injury or death could occur.

The brake is factory set and is not adjustable. If the brake fails to hold the load or if downward drift becomes excessive the brake must be replaced.

DIRECTIONAL CONTROL

Motor direction is controlled by either a solenoid pack or sealed contactor. Schematically, they are identical - two double pole-double throw solenoids are used to reverse polarity to the motor terminals.

Signal voltage, controlled by the pendant, energizes the selected directional solenoid, directing power to the winch terminal through the normally open terminal. The other terminal remains grounded through the normally closed terminal of the other solenoid.

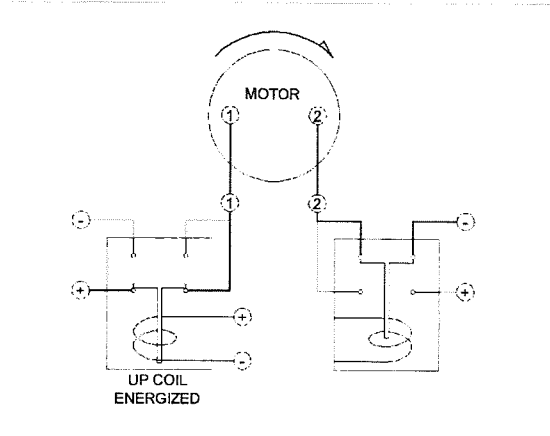
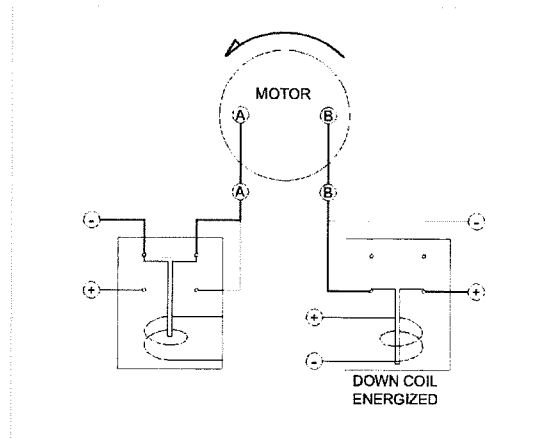

HYDRAULIC SYSTEM

Power Up – Gravity Down Elevation

The hydraulic system consists of the hydraulic pump assembly with solenoid valve and the elevation cylinder.

PUMP ASSEMBLY

The hydraulic pump assembly consists of a 12-Volt D.C. electric motor, pump, solenoid valve, relief valve, and reservoir.

The pump provides fluid pressure to the elevation cylinders to raise the boom. The pump motor is activated by the pump solenoid when Boom Up is activated.

When energized, the solenoid valve opens an internal path to tank. The weight of the boom and/or load forces the fluid back to tank.

The system incorporates an adjustable relief valve to prevent damage that can be caused by over pressurizing the system. It is set at the factory and should not be altered.

Servicing the hydraulic pump consist of maintaining the oil level and ensuring that the oil is not contaminated by water, dirt, rust, etc. The reservoir should be kept as full as possible at all times so that condensation cannot form inside the tank.

CYLINDER

The elevation cylinder is a single acting ram type cylinder. Fluid pressure extends the cylinder to raise the boom. The cylinder is held by the pump assembly valve. When the valve is open the weight of the boom and load force the fluid back into the tank.

A velocity fuse is installed in the extend port to prevent the cylinder from collapsing in the event of sudden pressure loss, such as a hose rupture.

LOAD SENSOR

A normally closed pressure switch is installed in the elevation cylinder to act as a load limiting device. When the pressure reaches overload the switch opens and power to the boom down and hoist up switches is interrupted. Boom up and hoist down will continue to function.

WARNING!

The operator must never rely on the load sensor alone. All load weights must be known and load limits adhered to at all times.

There is no anti-two blocking feature on this crane. The operator must always be aware of the hook and travel block position and ensure that the crane is never two-blocked (allowing the travel block or hook to contact the crown plate.)



MANUAL FUNCTIONS

EL Cranes

EXTENSION

The boom may be manually extended as needed. The boom must be set to the desired length before lifting the load. A boom stop is provided to prevent the inner boom from being inadvertently removed from the outer boom.

CAUTION!

All boom pins must be in place before lifting the load. The boom stop will not support a load. If proper boom pins are not installed the boom may collapse under load causing serious damage and possible injury or death.

ROTATION

The crane must be rotated manually. Taper roller bearings are utilized to reduce the force required.

CAUTION!

The force required to rotate the crane will increase dramatically if the truck is not level or if the load causes the truck to lean. Outriggers or jackstands **MUST** be used.

CAUTION!

Extreme caution must be used when rotating heavy loads. Even with the use of outriggers or jackstands the truck may tilt as the crane is rotated. Even a small lean may cause the load to become uncontrollable.

BRAKE

The crane is equipped with a hand tightened band brake to help control the load when rotating.

CAUTION!

Even with the brake tightened the load may become uncontrollable if the vehicle becomes unlevel.

CAUTION!

The brake is not designed nor intended to hold the crane during transit. The crane must be held by a boom rest and/or tethered to the truck when not in use.



TROUBLESHOOTING ELECTRIC HOIST

Permanent Magnet, Contactor Controlled

IMPORTANT NOTE!

The importance of first physically checking every connection between the battery and the crane cannot be overstressed!

Poor connections or poor grounding account for a large percentage of hoist problems. Time is often wasted chasing other probable causes only to eventually find a loose or corroded connection. **Measuring the voltage is not sufficient.** Often a poor connection will allow enough amperage to operate a meter or test light, but not enough to operate the hoist, which requires very high amperage.

If the problem is random and intermittent then it is almost assuredly a loose or bad connection.

Another common problem is low battery voltage. Even if the battery is good when troubleshooting begins, running the winch can quickly drain a battery. If it can be done safely, it is best to have the vehicle running.

Also check the control socket and plug for bent, corroded, or dirty pins.

CAUTION!

As the motor approaches stall, due to low voltage or excessive load, a very rapid heat build up occurs which will quickly damage the motor. If the motor is not turning, do not operate the switch for more than a second. Allow the motor to cool between attempts to make it run.

HOIST OPERATES IN ONLY ONE DIRECTION

If the hoist only operates in one direction swap the control wires on the contactor. Activating the pendant switch in the working direction should now operate the hoist in the previous non-working direction.

Example: if hoist up is not working, after swapping the control wires activating the hoist down switch should cause the hoist to go up.

If it does then the hoist and contactor are working correctly and the problem is in the pendant crane socket or wiring. If it does not then the problem is the contactor or brake.

If the motor tries to turn but stalls then the problem is most likely the brake. Also, if the contactor makes a clicking noise then that is a good indication that it is working and, again, the problem is most likely the brake.

If the control wires were swapped in the previous step, return them to their original positions. Swap the motor wires (labeled 1 and 2). It is usually easiest to swap them at the motor.

Activating the pendant switch in the working direction should now operate the hoist in the previous non-working direction.

Example: if hoist up is not working, after swapping the motor wires activating the hoist down switch should cause the hoist to go up.

If it does, then one side of the contactor is not working and it needs to be replaced.

If it does not work, the problem is a brake malfunction. Inspect the brake installation. Correct any problems found. The brake cannot be repaired. Replace if any damage is found.



HOIST DOES NOT RUN IN EITHER DIRECTION

If the hoist does not run in either direction then the problem is either lack of power to the control socket or pendant, lack of sufficient power to the motor, or hoist brake malfunction or motor failure.

If the contactor clicks when the switch is activated then the control socket is getting power.

If all connections have not been checked, do so now. Also ensure that the battery still has sufficient power. As a rule of thumb, if it has enough power to start the engine, then it is good.

Activate the winch toggle switch and check for voltage at motor contacts. If positive voltage is measured at both terminals, the problem may be the ground wire from the contactor. Check for tightness or corrosion on this wire.

Once sufficient power is ensured, if there is any indication that the motor is trying to turn but stalls the problem is the brake – have it replaced.

If there is no indication that the motor is trying to turn and the contactor has been tested, then replace the motor.

TESTING THE PENDANT AND CONTROL WIRING

If the problem is narrowed to the control wiring, it is most likely caused by a cut or disconnected wire. A visual inspection of the wiring should be made and repairs made as necessary.

Refer to the schematic and pendant drawing for pin functions and locations.

If no visual defects are found and if a continuity tester is available, disconnect the pendant and check for continuity between the control socket pin and terminal at the contactor.

Alternately, a piece of wire or metal object may be used to short between the control socket power pin and the socket hoist pin(s). If the hoist operates then the problem is in the pendant.

If not, check for power at the control socket power pin. If there is no power, trace the wiring back, checking each connection until the problem is found. Correct as necessary.



TROUBLESHOOTING HYDRAULIC SYSTEM

Power Up-Gravity Down Elevation

IMPORTANT NOTE!

The importance of first physically checking every connection between the battery and the crane cannot be overstressed!

Poor connections or poor grounding account for a large percentage of electrical problems. Time is often wasted chasing other probable causes only to eventually find a loose or corroded connection. **Measuring the voltage is not sufficient.** Often a poor connection will allow enough amperage to operate a meter or test light, but not enough to operate the motor, which requires very high amperage.

If the problem is random and intermittent then it is almost assuredly a loose or bad connection.

Another common problem is low battery voltage. Even if the battery is good when troubleshooting begins, running the motor can quickly drain a battery. If it can be done safely, it is best to have the vehicle running.

Also check the control socket and plug for bent, corroded, or dirty pins.

CAUTION!

As the motor approaches stall, due to low voltage or excessive load, a very rapid heat build up occurs which will quickly damage the motor. If the motor is not turning, do not operate the switch for more than a second. Allow the motor to cool between attempts to make it run.

PUMP DOES NOT RUN

If both the pump and winch are not working, the problem is power related or control wiring related. Troubleshoot those areas first.

If the solenoid is actuating it will make a clicking noise. If the solenoid is not clicking, check for power at the coil input (small screw terminal) when the Boom Up switch is activated. If there is no power then the problem is the control wiring.

If the coil is getting power when the switch is activated, but not clicking then the problem is most likely the solenoid.

If the solenoid is clicking check for full power input to the solenoid. Trace the wiring back to the crane input, checking for power at each connection until the problem is found. If full electrical power to the motor is confirmed then the motor is faulty and should be replaced.

BOOM DOES NOT GO DOWN

If the boom does not go down then it may be physically restrained or the solenoid valve is not opening.

If there is no load on the boom try pulling it down while activating the Boom Down switch. If that works then lubricate the cylinder pivots and correct any binding.

NOTE!

If the pressure switch is open, by either an overload or switch malfunction then the boom will not go down.

To determine if solenoid valve is energizing remove the retaining nut and slide the coil away from the base about ¼". Activating Boom Down should energize the coil, creating a magnetic force that tends to pull the coil back on. If this pull is not felt then the coil is not being energized and the control wiring needs to be investigated.

If the coil is energizing and the boom does not go down then the valve is faulty and needs to be replaced.



TESTING THE PENDANT AND CONTROL WIRING

If the problem is narrowed to the control wiring, it is most likely due to a cut or disconnected wire. A visual inspection of the wiring should be made and repairs made as necessary.

To narrow the problem to either the crane wiring or the pendant, use a piece of wire or metal object to short between the control socket power pin and the applicable function pin (see the electrical schematic).

If the function operates then the problem is in the pendant. Have it repaired or replaced.

If the function does not operate, check for power at the control socket power pin. If it does not have power then trace the wiring back until the problem is found.

BOOM DOWN AND/OR HOIST UP NOT WORKING

If both Boom Down **and** Hoist Up are not working then the problem is with the safety system. If just one of these functions is not working, the safety system must still be checked.

First ensure that the crane is not overloaded. Check for power at the Safety Function power pin on the control socket.

If it does not have power then the load sensor is either not receiving power or is tripped. Check for continuity across the pressure switch leads.

If the pressure switch is closed, trace the power back until the problem is found.

If the Safety Function Power pin does have power, then the problem is with the pendant. Have it repaired or replaced.



SECTION 3 CRANE SPECIFICATIONS

MODEL 206EL CRANES

MOMENT RATING 6500 FT-LBS

MAX SINGLE LINE LOAD 1000 LBS

MAX DOUBLE LINE LOAD 2000 LBS

LIFTING CAPACITIES AT VARIOUS LOAD RADII

LOAD RADIUS (FT)	CAPACITY (LBS)
3	2000
5	1300
6	1083
7	929
9	722

POWERED FUNCTIONS AND EXPECTED TIMES

WINCH	UP: 2.3 s	DOWN: 2.2 s	1 REVOLUTION
ELEVATION	UP: 13 s	DOWN: 31 s	75° NO LOAD
	15 s	21 s	75° 300 LBS AT 7.25'

ELECTRICAL REQUIREMENTS

VOLTAGE	12 VDC	
CIRCUIT BREAKER	150 AMP	
FUSE	15 AMP	(CONTROL WIRING)

MOUNTING BOLTS

½-13 GRADE 8 TORQUE 120 FT-LBS RE-TORQUE EVERY 4 MONTHS

LUBRICATION

Grease cylinder pivots and travel block sheave every 8 hr or operation, bi-weekly or as needed.

HYDRAULIC FLUID

STANDARD Chevron AW Hydraulic Oil 46 or equivalent SAE 15 weight oil

COLD WEATHER AW 32 or equivalent SAE 10 weight oil

Check daily, fill as needed. Keep reservoir as full as possible to prevent condensation.



F1451-C
12/15/09

HOUSTON, TEXAS
FAX: (800) 824-5559 (USA & Canada)
FAX: (713) 688-6324
PHONE: (713) 688-5533
www.liftmoore.com

CRANE SPECIFICATIONS

(Continued)

MODEL 206WEL CRANES

MOMENT RATING 6500 FT-LBS

MAX SINGLE LINE LOAD 2000 LBS

LIFTING CAPACITIES AT VARIOUS LOAD RADII

LOAD RADIUS (FT)	CAPACITY (LBS)
<3	2000
4	1625
6	1083
8	813
10	650
12	542

POWERED FUNCTIONS AND EXPECTED TIMES

WINCH	UP: 5 s	DOWN: 5 s	1 REVOLUTION
BOOM ELEVATION	UP: 27 s	DOWN: 21 s	

ELECTRICAL REQUIREMENTS

VOLTAGE	12 VDC	
CIRCUIT BREAKER	150 AMP	
FUSE	15 AMP	(CONTROL WIRING)

NOTE: FUNCTION TIMES ARE BASED ON THESE INPUT VALUES

F1451-C
12/15/09HOUSTON, TEXAS
FAX: (800) 824-5559 (USA & Canada)
FAX: (713) 688-6324
PHONE: (713) 688-5533
www.liftmoore.com

PERIODIC MAINTENANCE SCHEDULE MODEL 206 CRANES		
BOLTS		
MOUNTING BOLTS	1/2-13 GRADE 8 TORQUE 110FT-LBS DRY	EVERY 4 MONTHS
LUBRICATION		
GREASE FITTINGS	SEE DRAWING 50470	EVERY OTHER WEEK
HYDRAULIC FLUID	STANDARD Chevron AW Hydraulic Oil 46 or equivalent SAE 15 weight oil COLD WEATHER AW 32 or equivalent SAE 10 weight oil	CHECK DAILY, FILL AS NEEDED
BEARING (ZERK AND TEETH)	Oil Center Research PM 600 Military grease or equivalent Benton Based Grease NLGI Grade 2	EVERY 6 HOURS OF OPERATION

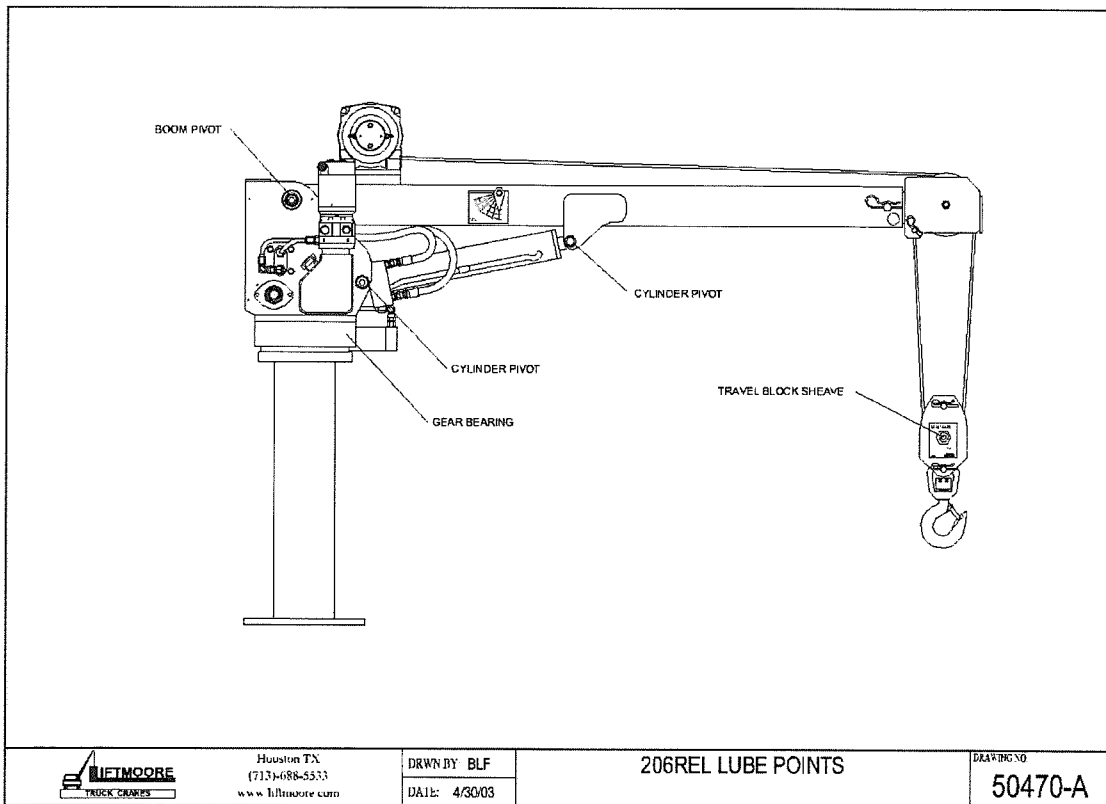

Houston TX
(713) 688-5533
www.liftmoore.com

DRWN BY BLF
DATE: 4/30/03

206REL LUBE POINTS

DRAWING NO
50470-A



F1451-C
12/15/09

HOUSTON, TEXAS
FAX: (800) 824-5559 (USA & Canada)
FAX: (713) 688-6324
PHONE: (713) 688-5533
www.liftmoore.com

THIS PAGE INTENTIONALLY LEFT BLANK



HOUSTON, TEXAS
FAX: (800) 824-5559 (USA & Canada)
FAX: (713) 688-6324
PHONE: (713) 688-5533
www.liftmoore.com

EL W

Items with * have detailed DWG's.

P/N 24007 - BOX, CRANE PARTS 206EL W

- 1) P/N 24006 - MANUAL, CRANE 206EL W..... 1pc
- 2) P/N 33021 - WIRE, BATTERY #1 X 25' W/MECON..... 1pc
- 3) P/N 26084 - WIRE, GROUND 1/0 X 3' LONG..... 1pc
- 4) P/N 30760 - PIN, HITCH 0.75 X 4.50 W/H-PIN..... 1pc
- 5) P/N 30815 - SCREW, HHC 0.50-13 X 2.50 GR8..... 4pcs
- 6) P/N 30474 - WASHER, LOCK 0.50 GR5 PLATED..... 4pcs
- 7) P/N 31957 - NUT, HEX 0.50-13 GR8 PLATED..... 4pcs
- 8) P/N 16878 - BREAKER, CIRCUIT 150 AMP..... 1pc
- 9) P/N 16915 - TERMINAL, LUG #1 GA 0.25 DIA..... 2pcs
- 10) P/N 30766 - SWITCH, DISCONNECT..... 1pc
- 11) P/N 17010 - BRACKET, SWITCH MNT. ELE. CRN..... 1pc
- 12) P/N 17063 - TERMINAL, LUG #1 GA 0.37 DIA..... 2pcs
- 13) P/N MH*03171 - CAP, BREATHER 3/8 NPT-MONARCH..... 1pc
- 14) P/N 17181 - SCREW, HHC 0.62-11 X 2.75 GR8..... 4pcs
- 15) P/N 34038 - NUT, HEX 0.62-11 GR8 PLATED 4pcs
- 16) P/N 31461 - WASHER, LOCK 0.62 GR5 PLATED..... 4pcs
- 17) P/N 31054 - WASHER, FLAT 0.62 SAE GR8..... 4pcs
- 18) P/N 22571 - INSTALLATION INTS. 206..... 1pc
- 19) P/N 26505 - DECAL, LOAD CAPACITY 206 2pc
- 20) *P/N 17216 - CONTROL, PENDANT 2700A 1pc



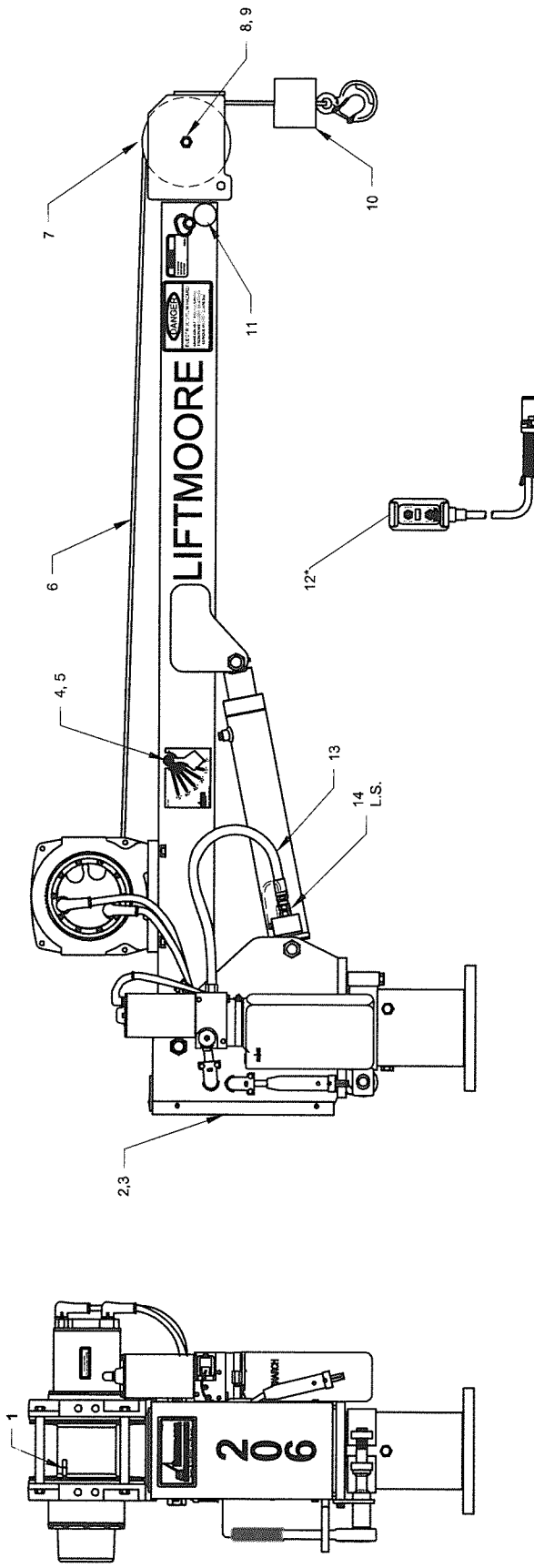

ITEMS WITH * HAVE DETAIL DRAWINGS

#	PN	DESCRIPTION	QTY	#	PN	DESCRIPTION	QTY	#	PN	DESCRIPTION	QTY
1	70022	WEDGE, WIRE ROPE ANCHOR	1	7	19628	SHEAVE ASSY 5.90PD X 0.25 ROPE	1	13	33565	HOSE, HYD #6 26.00"	1
2	19405	COVER, BACK 206	1	8	32660	SCREW, HHC 0.50-13 X 2.50 GR8	1	14	22341	SWITCH, PRES ASSY 2700PSI DTCH	1
3	32589	SCREW, HWHSMS 0.25-20 X 0.75	4	9	30835	NUT, HEX NYLOC 0.50-13 GRADE 5	1	NOT SHOWN:			
4	22394	PENDULUM, LOAD RADIUS DIA. HD	2	10	30213	PICKLE (WEIGHT)	1	△	26506	PLATE, SERIAL 206W	1
5	31017	SCREW, SHOULDER 0.31-18 X 0.75	2	11	31036	STOP, BOOM INNER ASSY STD.	1	△	19449	DECAL KIT 206	1
6	31220	ROPE, WIRE 0.25 X 62' W/THB&HK	1	12	17216	CONTROL, PENDANT 2700A	1				

	Houston TX (713)-688-5533 www.liftmoore.com	DRWN BY: JE DATE: 8-30-10	CRANE ASSY 206EL W W/ WINCH P/N 23872 DRAWING NO. 24005-A

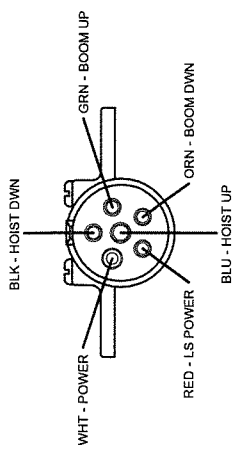

FRONT OF PLUG

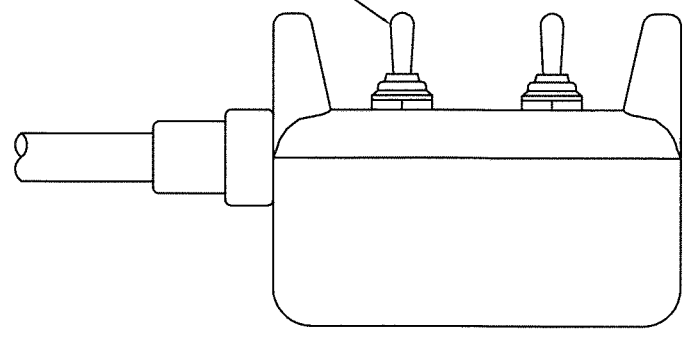
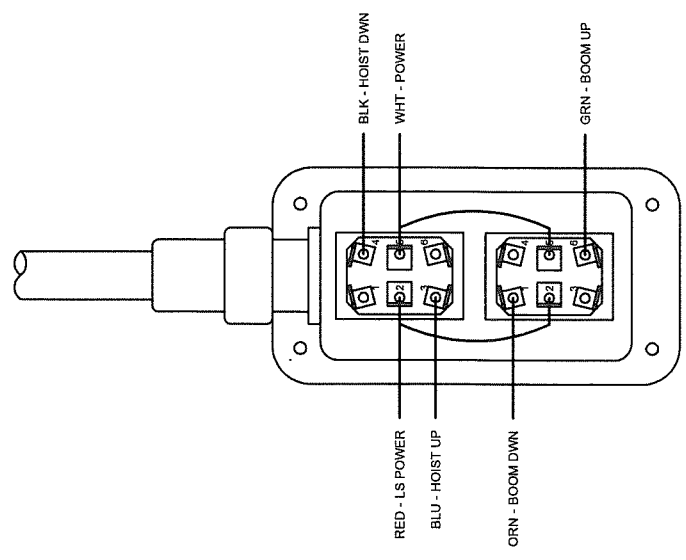
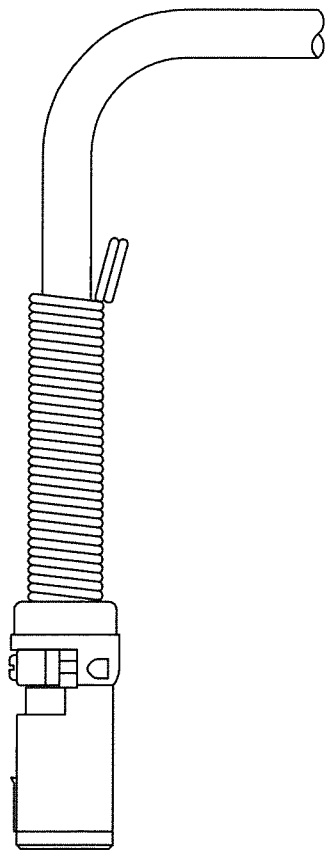

REPLACEMENT FOR TOGGLE SWITCH
 RC*6GM5S-73
 SWITCH, TOGGLE DPDT MOM ST

17264 DECAL, CONTROL PENDANT 2-F/H&B
 2-FUNCTION / HOIST & BOOM ELEV

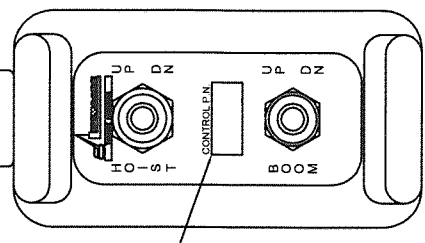

Houston TX
 (713)-688-5533
 www.iftmoore.com



DRWN BY: JC

DATE: 07/10/09

CONTROL, PENDANT 2700A
 2 FUNCTION - WIRED FOR L.S.

DRAWING NO.

17216-B

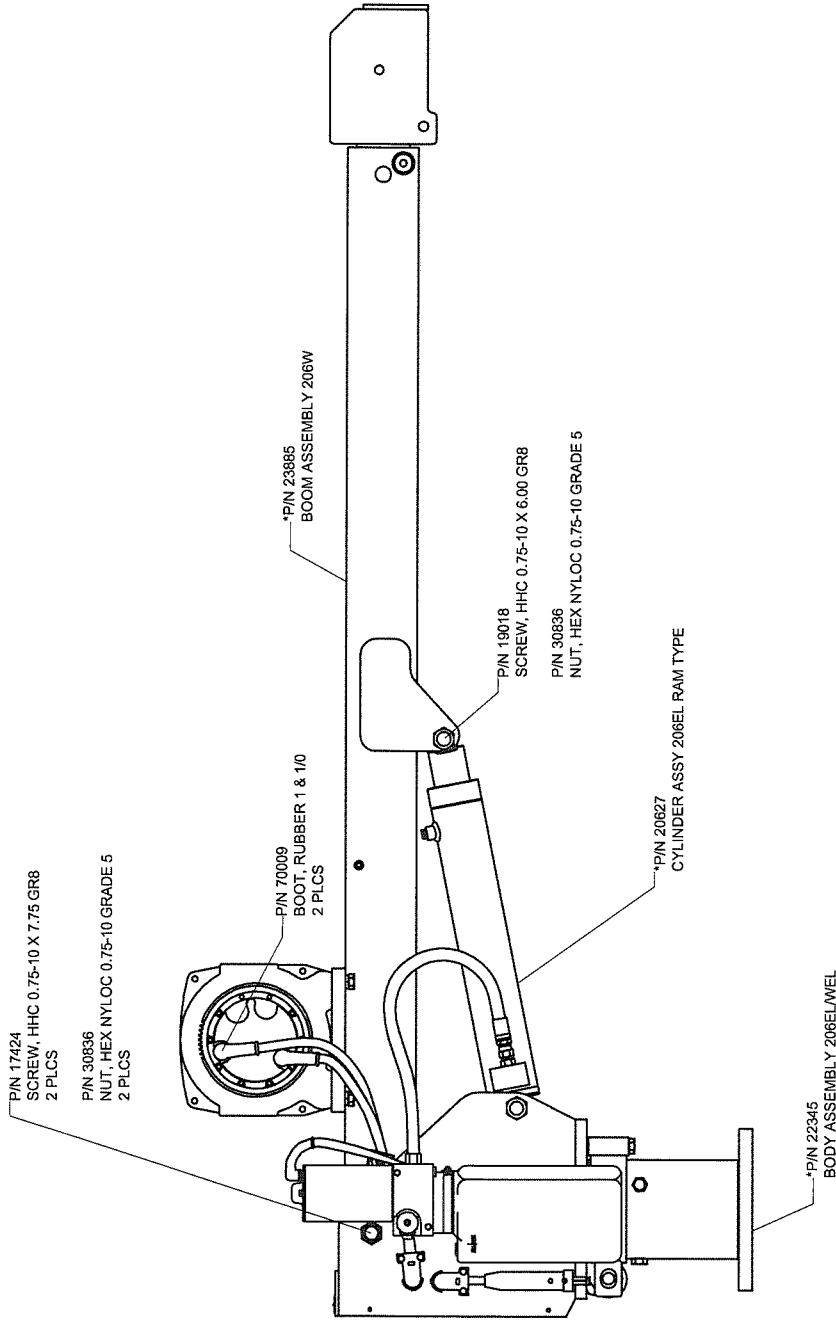

ITEMS WITH * HAVE DETAIL DRAWINGS

BOOM-BODY ASSY 206EL W
 WITH WINCH P/N 23872

DRAWING NO.
24004-0

DRWN BY: JE

DATE: 8/26/10

Houston TX
 (713)-688-5533
 www.lifmoore.com



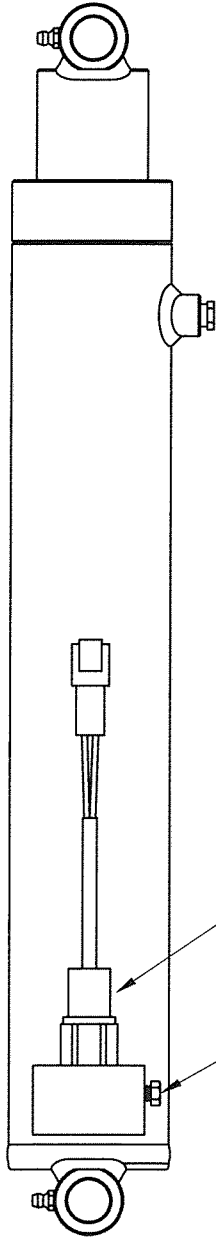

P/N 22341
SWITCH, PRES ASSY 2700PSI DTCH
(NOT PART OF ASSEMBLY)

P/N 30457
SCREW, HHC 0.25-20 X 0.75 GR5

P/N 30830
NUT, HEX 0.25-20 GR2 PLATED

FOR UPLIMIT SWITCH

P/N 20611
CYLINDER, 2.5 X 13.0 X 2.00RAM

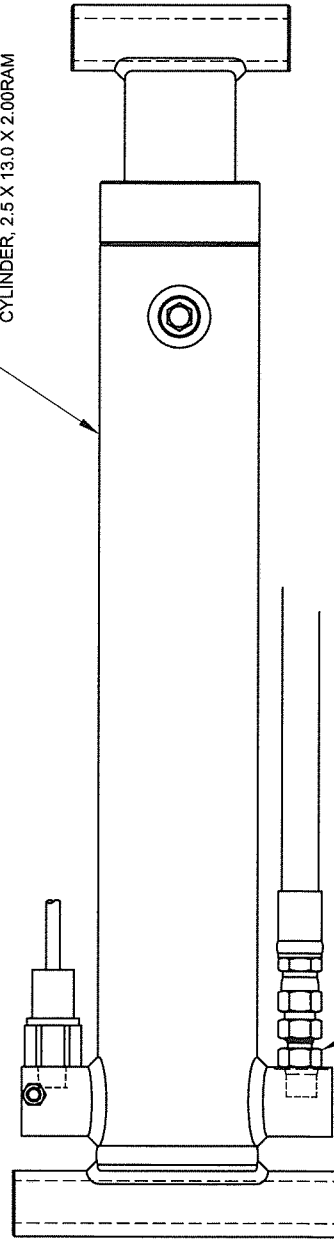

P/N 17115
FUSE, HYD. VELOCITY 6MJ-6MO

Houston TX
(713)-688-5533
www.liftmoore.com

CYLINDER ASSY 206EL RAM TYPE

DRWN BY: JC

DATE: 3/19/08

DRAWING NO.

20627-A



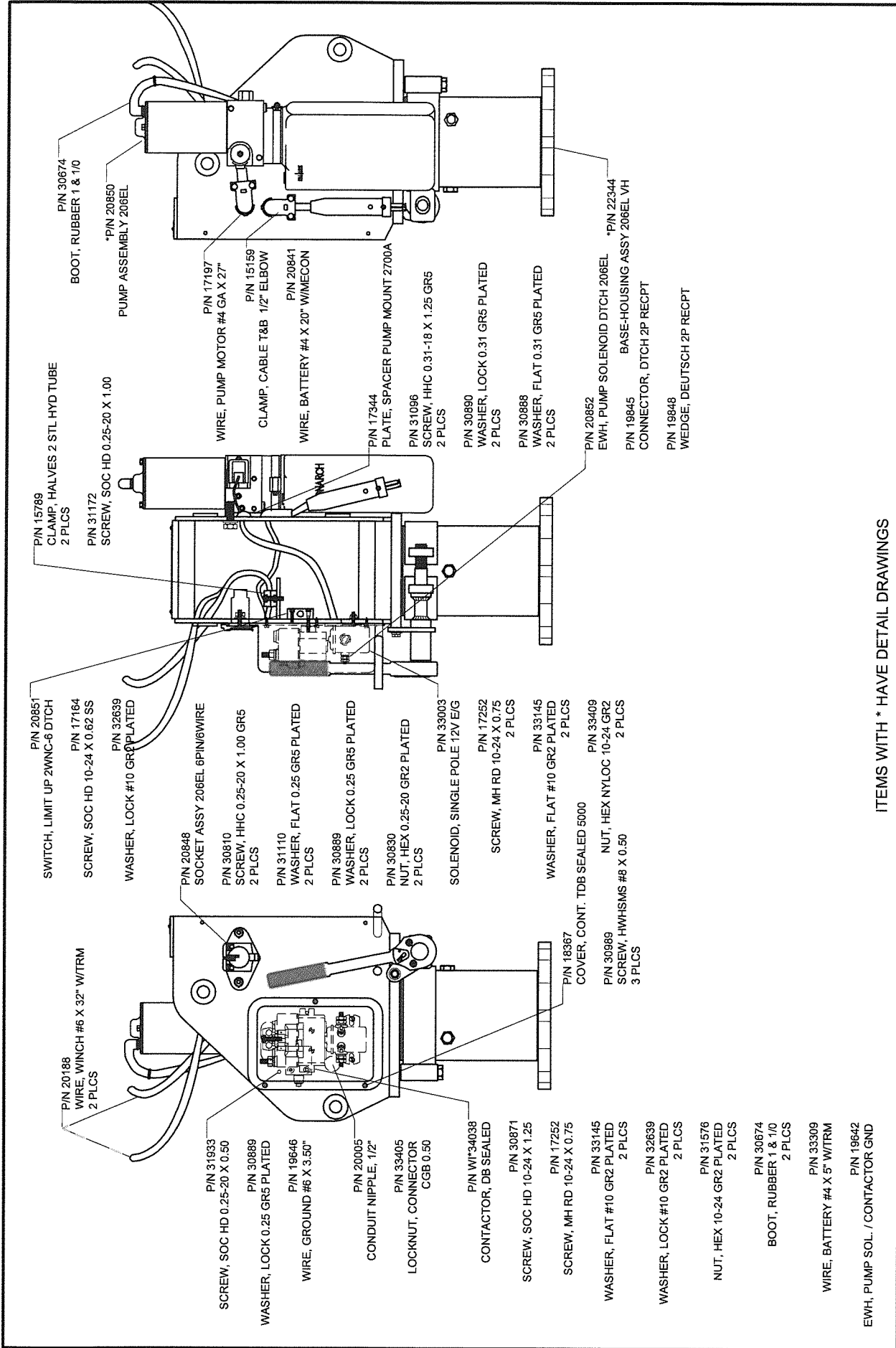

ITEMS WITH * HAVE DETAIL DRAWINGS

	Houston TX (713)-688-5533 www.lifmoore.com	DRWN BY: JC DATE: 4/28/09	DRAWING NO. 22345-B
	BODY ASSEMBLY 206EL/WEL SHORTY & VARIABLE HEIGHT		

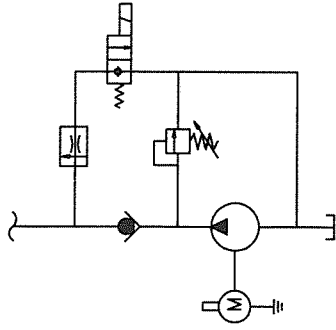
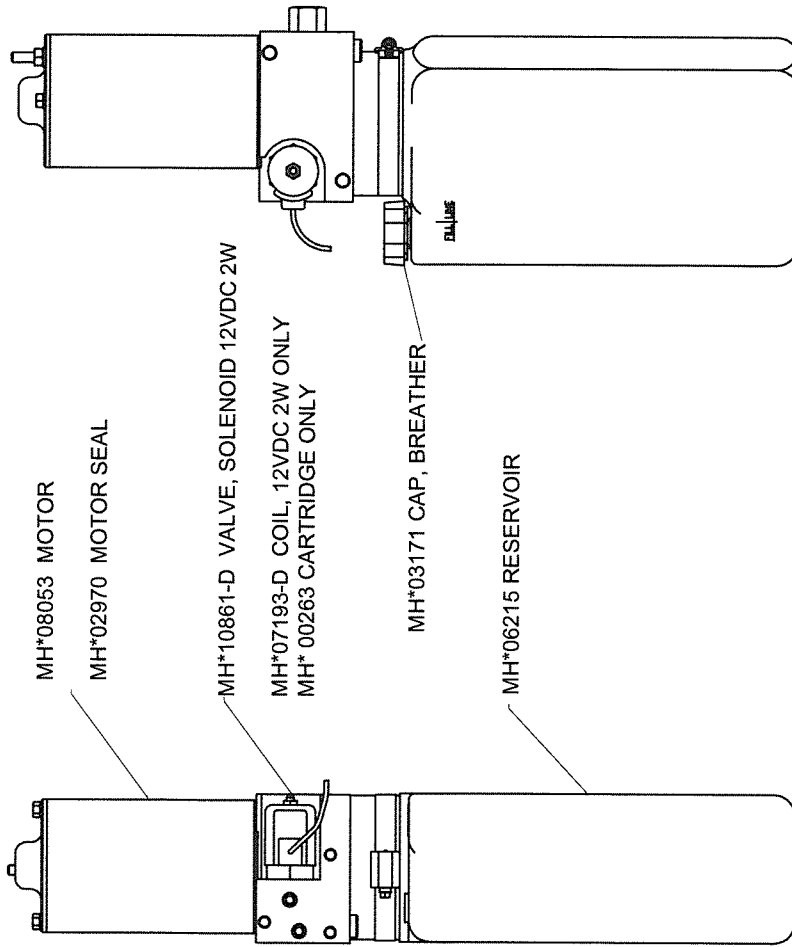
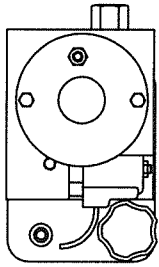

SCHEMATIC

**HYDRAULIC POWER UNIT
FOR POWER ELEVATION / GRAVITY DOWN CRANES**

2-Way/2-Position Normally Closed Solenoid Operated
Cartridge Style Pressure Compensated Lowering Valve
Externally Adjustable Relief Valve

VERTICAL MOUNT

ITEMS NOT SHOWN:

- MH*01459-08.50 SUCTION TUBE
- MH*01479-08.00 RETURN TUBE



Houston TX
(713)-688-5533
www.iftmoore.com

DRWN BY: JC

DATE: 02/26/10

PUMP, HYDRAULIC 2700A VERT MNT

DRAWING NO.

17087-C

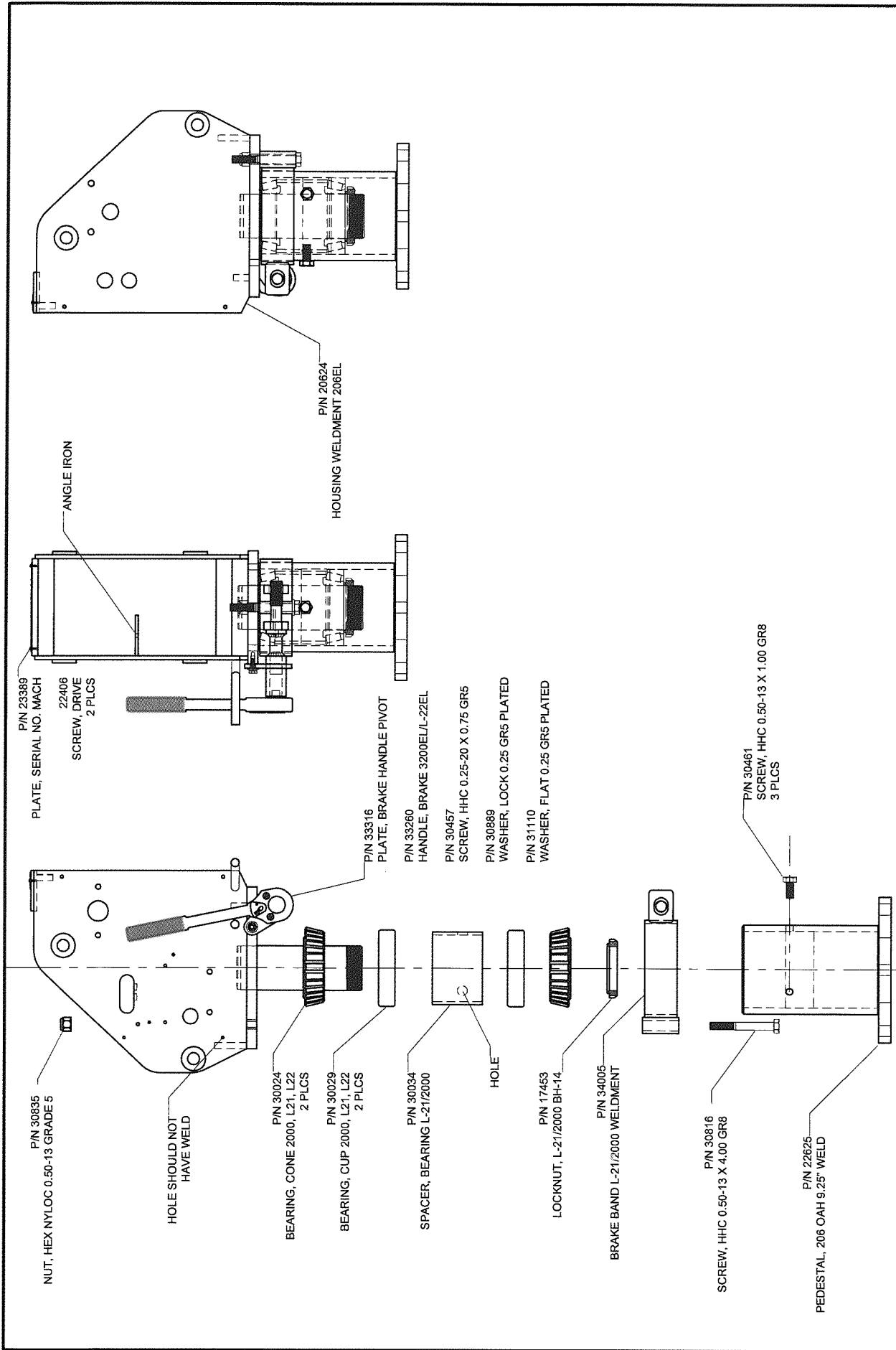

	Houston TX (713)-688-5533 www.liftmoore.com	DRWN BY: JC DATE: 12/14/09	BASE-HOUSING ASSY 206EL/WEL SHORTY & VARIABLE HEIGHT	DRAWING NO. 22344-D
--	---	-------------------------------	---	-------------------------------

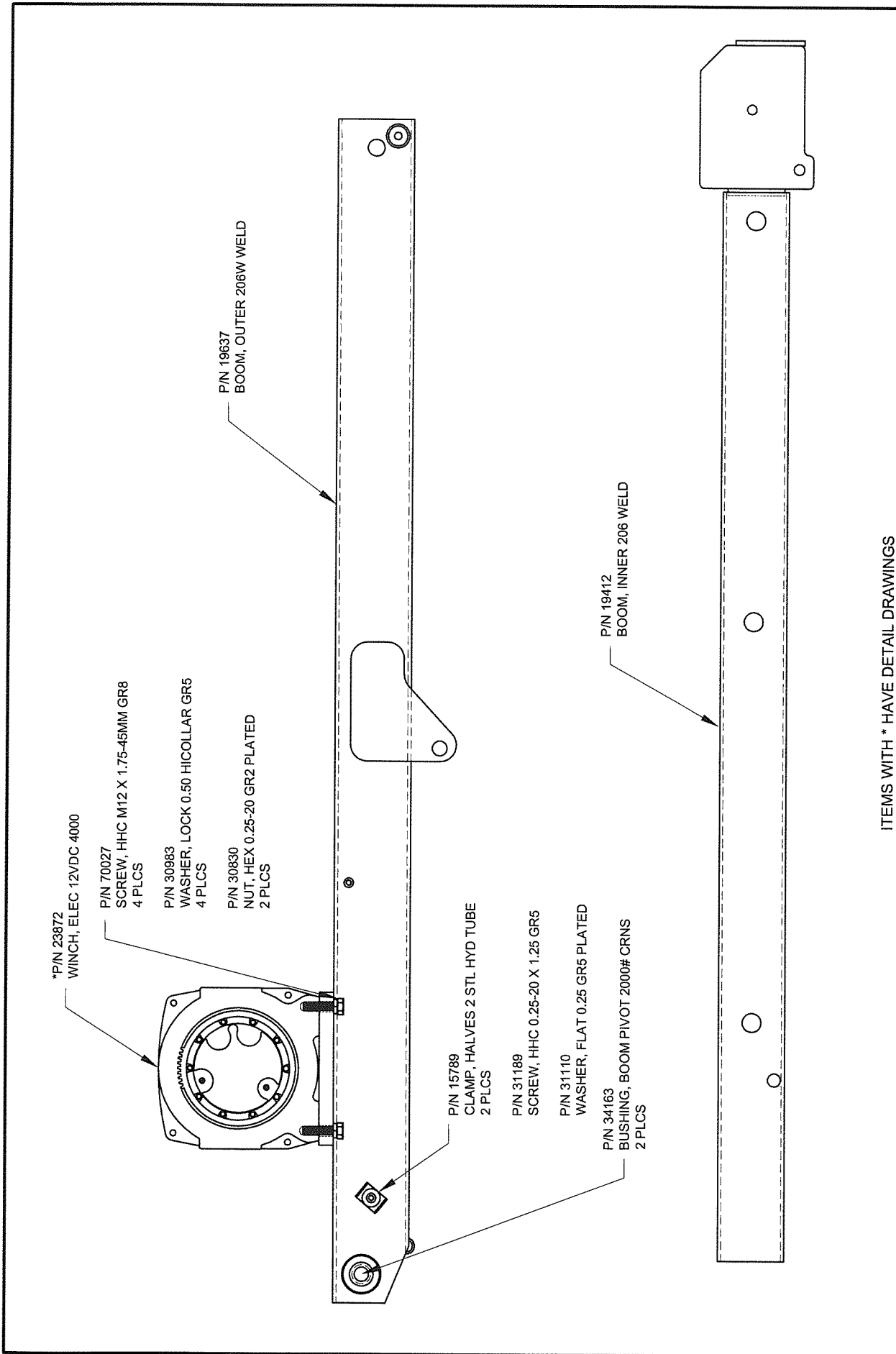

- *P/N 23872
WINCH, ELEC 12VDC 4000
- P/N 70027
SCREW, HHC M12 X 1.75-45MM GR8
4 PLCS
- P/N 30983
WASHER, LOCK 0.50 HICOLLAR GR5
4 PLCS
- P/N 30830
NUT, HEX 0.25-20 GR2 PLATED
2 PLCS
- P/N 15789
CLAMP, HALVES 2 STL HYD TUBE
2 PLCS
- P/N 31189
SCREW, HHC 0.25-20 X 1.25 GR5
- P/N 31110
WASHER, FLAT 0.25 GR5 PLATED
- P/N 34163
BUSHING, BOOM PIVOT 2000# CRNS
2 PLCS
- P/N 19637
BOOM, OUTER 206W WELD
- P/N 19412
BOOM, INNER 206 WELD

ITEMS WITH * HAVE DETAIL DRAWINGS

	Houston TX (713)-688-5533 www.liftmore.com	DRWN BY: JS DATE: 7/26/10	DRAWING NO. 23885-0
	BOOM ASSEMBLY 206W W/ WINCH P/N 23872		

WINCH DC2000 12VDC P/N 23872

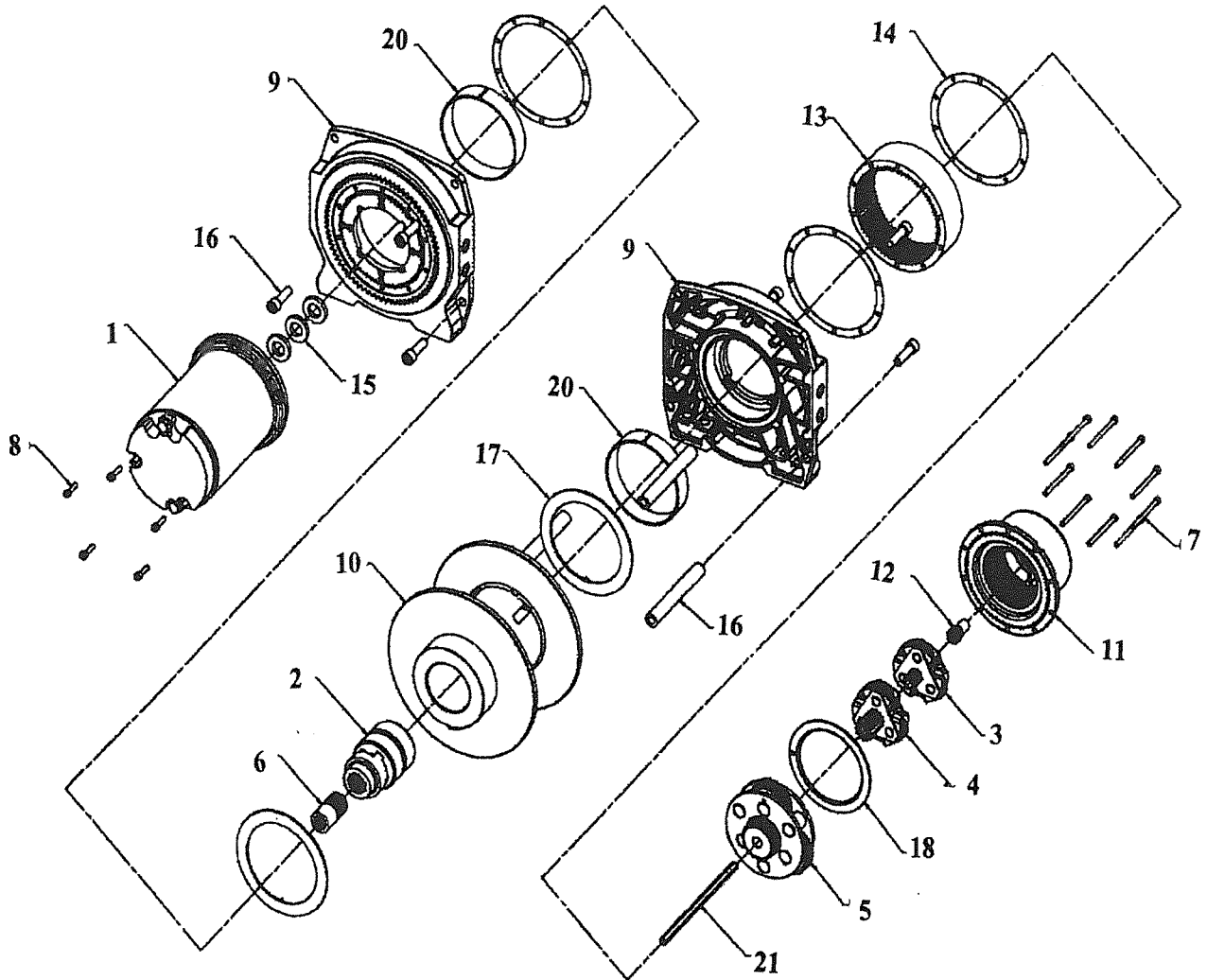

SERVICE PARTS LIST: DC2000LF HOIST-12V P/N 23872

ITEM REFERENCE		ITEM / KIT No.
1	MOTOR SPLINED 12V DC	WI*84211
2	BRAKE ASSEMBLY DC2000	WI*63550
3	CARRIER ASSY, STAGE 1	WI*28430
4	CARRIER ASSY, STAGE 2	WI*28433
5	CARRIER ASSY, STAGE 3	WI*28115
6	COUPLER, MOTOR/BRAKE	WI*32149
7	CPSCR, 10-24 X 2-1/4-HEX SOCKET HEAD-PI	WI*13850
8	CPSCR, SOC, 10-24 X 3/4, GR9 (KB)	WI*5553
9	(MTO) S/P DRUM SUPPORT, GEAR END	WI*85575
10	DRUM, (KB) 2000-MF, 4.25 DIA	WI*31618
11	SVC KIT END HOUSING SUBASSY, CLUTCH PLUG	WI*85583
12	GEAR, SUN, 12 TOOTH, STAGE 1	WI*13874
13	RING GEAR, ARG, 75 TOOTH	WI*25308
14	HOUSING, GASKET	WI*13848
15	SPACER, MOTOR	WI*15271
16	SVC KIT TIE ROD, ALUMN, .625 X 4.92	WI*85579
17	WASHER, TRUST, NYLATRON, CIM	WI*30277
18	WASHER, TRUST, NYLON, MIDRANGE	WI*13826
19	PARTS PACK, DC2000 HOIST	WI*60049
20	BUSHING DRUM NYLATRON	WI*30274
21	SHAFT-DRIVE-HEX 5/16 X 6.85	WI*84346



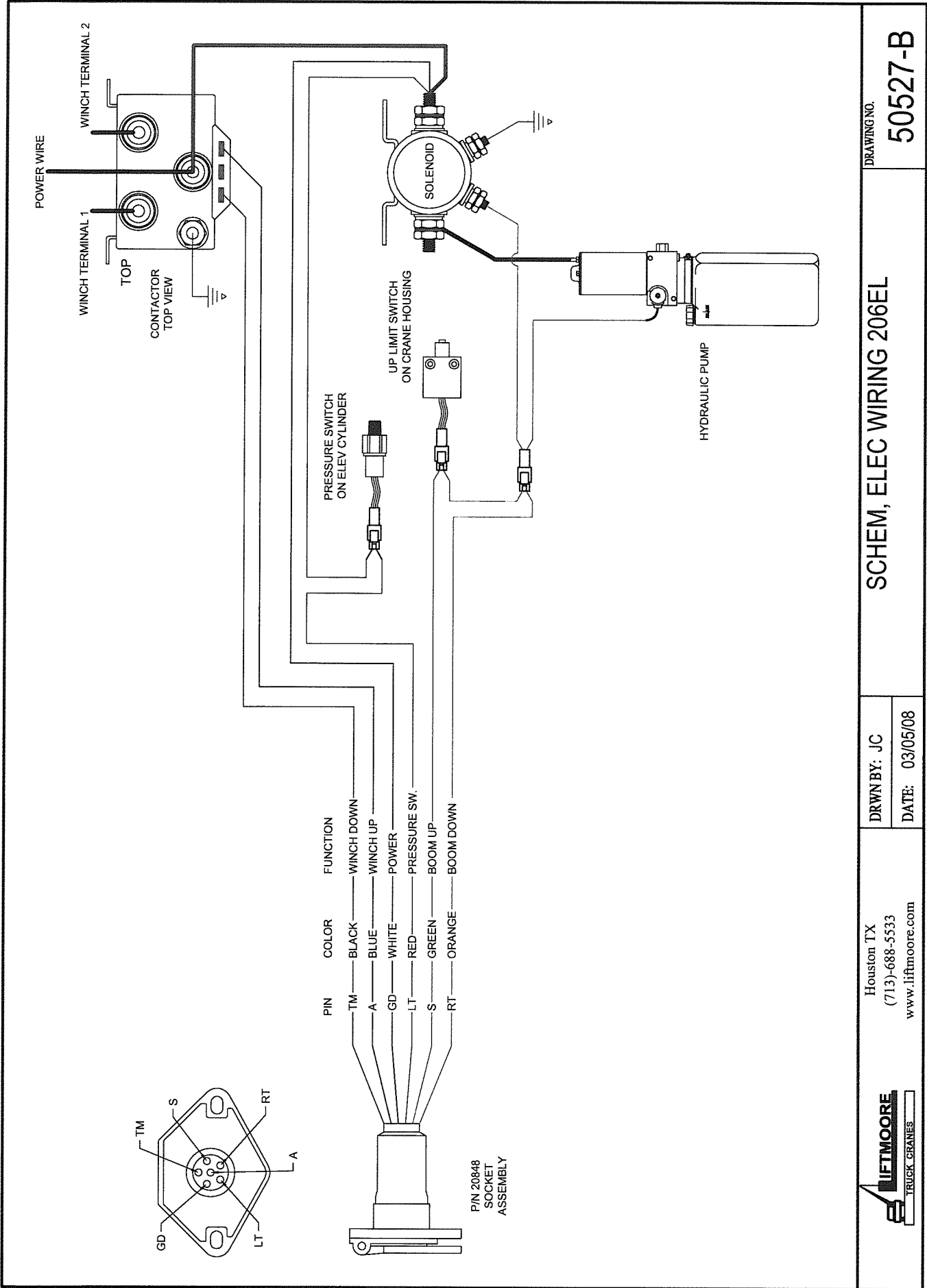

Houston TX
(713)-688-5533
www.liftmoore.com

DRWN BY: JC
DATE: 03/05/08

SCHEM, ELEC WIRING 206EL

DRAWING NO.

50527-B



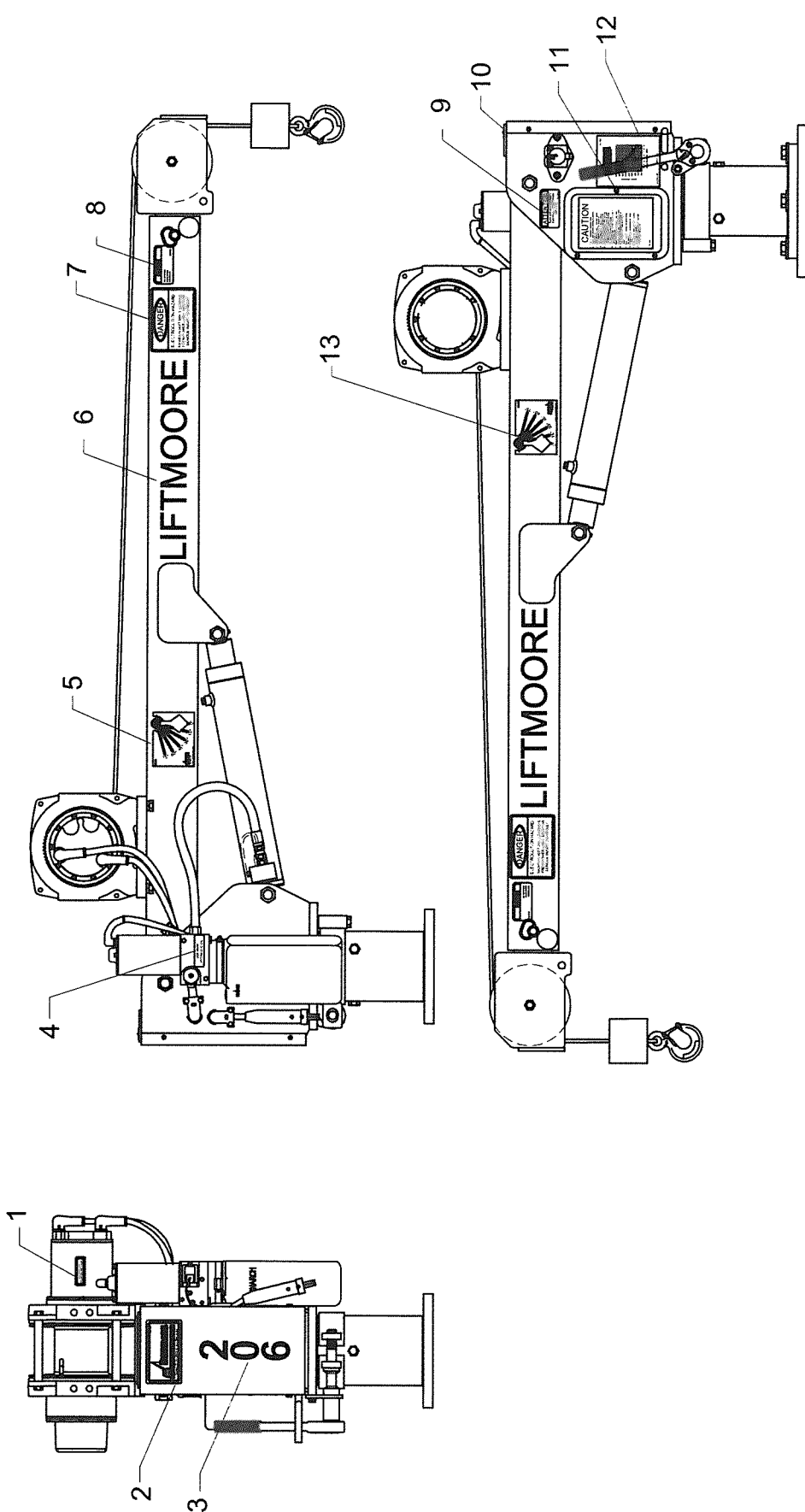

#	PN	DESCRIPTION	QTY	#	PN	DESCRIPTION	QTY	#	PN	DESCRIPTION	QTY
1	32608	DECAL, MOTOR MAGNETS DAMAGE	1	6	34041	DECAL, LIFTMOORE - 2.00"	2	11	16102	DECAL, CAUTION READ MANUAL	1
2	15582	DECAL, LOGO SMALL	1	7	15618	DECAL, DANGER ELECTRIC INJURY	1	12	26506	PLATE, SERIAL 206W	1
3	19464	DECAL, 206	1	8	15612	DECAL, CAUTION PIN MUST BE IN	1	13	22375	DECAL, ANGLE PENDULUM LEFT	1
4	16103	DECAL, USE 46AW HYD. OIL	1	9	15577	DECAL, ATTENTION BATTERY	1				
5	22376	DECAL, ANGLE PENDULUM RIGHT	1	10	23389	PLATE, SERIAL NO. MACH	1				

	Houston TX (713)-688-5533 www.liftmoore.com	DECAL DIAGRAM FOR THE 206WEL		DRAWING NO. 58414-0
		DRWN BY: AA DATE: 04/23/14		

THIS DRAWING INTENTIONALLY LEFT BLANK

FOR FUTURE ADDITIONS

OR

A PART OR FEATURE IS NOT APPLICABLE TO THIS CRANE



Houston TX
(713)-688-5533
www.liftmoore.com

DRWN BY:

DATE:

DRAWING NO.

LIFTMOORE LIMITED WARRANTY

Parts and Structural

Liftmoore, Inc. warrants each LIFTMOORE crane to be free from defects in materials and workmanship for twelve (12) months from the date of delivery to the original customer. Under the terms of this warranty the crane structural components manufactured by LIFTMOORE, Inc. are warranted for thirty-six (36) months from the date of delivery to the original customer. LIFTMOORE, Inc. will repair or replace, as its sole discretion, any equipment or part that is returned f.o.b. to LIFTMOORE, Inc.'s plant at 7810 Pinemont Drive, Houston, Texas 77040, or to one of its authorized dealers, and is found by LIFTMOORE, Inc. or its authorized dealer to have been defective at the time of original delivery.

The foregoing warranty is the exclusive warranty made by LIFTMOORE, Inc. with respect to its cranes and is in lieu of all other warranties. ANY AND ALL OTHER WARRANTIES, EXPRESS OR IMPLIED, INCLUDING ANY WARRANTY OF MERCHANTABILITY OR FITNESS OF ANY CRANE FOR A PARTICULAR PURPOSE OR OPERATION, ARE HERBY EXPRESSLY DISCLAIMED.

The foregoing warranty applies only to LIFTMOORE cranes under normal use and service and does not apply in the event of damage caused by repair or alteration or damage during shipment, accident, negligence, overloading, or misuse, including operator's failure to follow any of the instructions issued with the crane.

This warranty is limited to the original purchaser and is not assignable. In order to submit a claim, the original purchaser must provide a copy of the original invoice for the crane in question within twelve (12) months following the delivery date and within 30 days from the date of repair.

The warranty applies only when the LIFTMOORE crane is used for commercial purposes and does not cover any purchase for use for personal, family or household purposes.

LIMITATION OF LIABILITY: LIFTMOORE, Inc.'s liability for any losses or damages resulting from any cause whatsoever, including LIFTMOORE, Inc.'s NEGLIGENCE or from a defective crane irrespective of whether such defects are discoverable or latent, shall in no event exceed the purchase price of the crane to which losses or damages are claimed, or at the election of LIFTMOORE, Inc., the repair or replacement of the defective crane.

In no event shall LIFTMOORE, Inc. be liable for any special, incidental, or consequential damages, including commercial losses or costs of any kind sustained by purchaser or any other person or for any damages for which purchaser may be liable to other persons by reason of any defect in any LIFTMOORE crane or any part thereof.

LIFTMOORE, Inc. reserves the right to make changes in design or construction of its cranes at any time without obligating itself to make such changes on cranes previously manufactured.

No agent, employee, or representative of LIFTMOORE, Inc. has authority to amend or modify the foregoing warranty or to bind LIFTMOORE, Inc. by any other warranty, guaranty, or assumption of liability.

In the event any provision of this warranty is for any reason held ineffective, the remaining provisions shall remain in full force and effect.

Some states do not allow limitations on how long an implied warranty lasts or the exclusion or limitation of incidental or consequential damages, so the above limitations and exclusions may not apply to you. This warranty gives you specific legal rights, and you may also have other legal rights that vary from state to state.

