

TABLE OF CONTENTS
 USERS MANUAL P/N 23948
 MANUAL, CRANE 1032XP DTCH
 ATB LS; WINCH 19530; E-STOP

SECTION I
GENERAL OPERATION, INSPECTION, AND MAINTENANCE

| | | |
|---------------------------------|---------------|-----|
| CRANE SAFETY RULES | F1122-B | 1-1 |
| INTRODUCTION | F1111-D | 1-3 |
| OPERATING RESTRICTIONS | F1637-0..... | 1-4 |
| OPERATING PRACTICES..... | F1637-0..... | 1-4 |
| INSPECTION AND MAINTENANCE..... | F1113-C | 1-7 |
| MONTHLY INSPECTION REPORT..... | F1123-B | 1-9 |

SECTION II
CRANE SYSTEMS AND TROUBLESHOOTING

| | | |
|--|---------------|-----|
| PENDANT CONTROL SYSTEM | F1126-A | 2-1 |
| SAFETY SYSTEM..... | F1115-F | 2-2 |
| PROPORTIONAL HYDRAULIC SYSTEM | F1668-0..... | 2-3 |
| BASIC TROUBLESHOOTING | F1117-E..... | 2-5 |
| CONTROL TROUBLESHOOTING CHART..... | F1134-C | 2-6 |
| TROUBLESHOOTING SAFETY SYSTEM..... | F1254-A | 2-7 |
| TROUBLESHOOTING PROPORTIONAL SYSTEM..... | F1447-A | 2-8 |

SECTION III
CRANE SPECIFICATIONS

| | | |
|----------------------------------|--------------|-----|
| LIFTING CAPACITIES | F1642-0..... | 3-1 |
| POWER FUNCTIONS AND SPEEDS | F1642-0..... | 3-1 |
| BOLT AND LUBRICATION SPECS..... | F1642-0..... | 3-2 |
| CRANE LUBRICATION POINTS | F1642-0..... | 3-3 |

SECTION IV
PARTS

| | | |
|-----------------------------------|-------------------|------|
| BOX PARTS LIST | F1727-0..... | 4-1 |
| CRANE ASSEMBLY | DWG.23946-0 | 4-2 |
| PENDANT CONTROL | DWG.23793-A | 4-3 |
| RELAY BOX ASSEMBLY..... | DWG.22570-0 | 4-4 |
| TRAVEL BLOCK ASSEMBLY | DWG.22556-C | 4-5 |
| ANTI-TWO BLOCK ASSEMBLY | DWG.22908-A | 4-6 |
| BOOM-BODY ASSEMBLY | DWG.23945-0 | 4-7 |
| ELEVATION CYLINDER ASSEMBLY | DWG.21603-A | 4-8 |
| BODY ASSEMBLY | DWG.23581-A | 4-9 |
| MANIFOLD ASSEMBLY..... | DWG.23590-0 | 4-10 |
| MANIFOLD PRE-ASSEMBLY | DWG.23645-0 | 4-11 |
| BASE-HOUSING ASSEMBLY | DWG.23448-0 | 4-12 |
| ROTATION COMPONENTS..... | DWG.50570-B | 4-13 |



TABLE OF CONTENTS
USERS MANUAL P/N 23948
MANUAL, CRANE 1032XP DTCH
ATB LS; WINCH 19530; E-STOP

| | | |
|-----------------------------------|-------------------|------|
| BOOM ASSEMBLY – 15 FT | DWG.23836-0 | 4-14 |
| BOOM INNER ASSEMBLY – 15 FT | DWG.23838-0 | 4-15 |
| WINCH..... | DWG.50580-A | 4-16 |
| ELECTRICAL SCHEMATIC DTCH..... | DWG.50768-0 | 4-17 |
| HYDRAULIC SCHEMATIC | DWG.50770-0 | 4-18 |
| DECAL DIAGRAM | DWG.58372-0 | 4-19 |

WARRANTY..... F1442-A



F1728-0
08/02/10

HOUSTON, TEXAS
FAX: (800) 824-5559 (USA & Canada)
FAX: (713) 688-6324
PHONE: (713) 688-5533
www.liftmoore.com

CRANE SAFETY RULES

CAUTION!

1. READ AND UNDERSTAND OPERATOR'S MANUAL.
2. INSPECT VEHICLE AND CRANE, INCLUDING ITS OPERATION, BEFORE DAILY USE.
3. USE THIS EQUIPMENT ONLY ON SOLID LEVEL GROUND WITH OUTRIGGERS OR JACKSTANDS PROPERLY SET.
4. BEFORE OPERATING THE CRANE REFER TO MAXIMUM LOAD CHART ON CRANE FOR OPERATING LOAD LIMITS.
5. BE SURE LOAD BEING LIFTED IS WITHIN SAFE WINCH CAPACITY AS WELL AS SAFE CRANE CAPACITY. MULTI-PART LINE OPERATION IS REQUIRED WHEN SINGLE LINE LOAD CAPACITY OF WINCH IS EXCEEDED.
6. DO NOT OPERATE, WALK, OR STAND UNDER THE BOOM OR ANY SUSPENDED LOAD.
7. ALWAYS PAY OUT LOAD LINE BEFORE EXTENDING BOOM. WIRE ROPE DAMAGE AND / OR BREAKAGE MAY OCCUR.
8. BOOM MUST BE IN ITS REST BEFORE MOVING VEHICLE.
9. BOOM TIP MUST BE DIRECTLY OVER THE LOAD BEFORE ANY LIFTING IS STARTED. DO NOT DRAG LOADS WITH THIS CRANE.
10. MAINTAIN THIS CRANE AS REQUIRED IN THE OWNER'S MANUAL.
11. DO NOT ALLOW PERSONNEL TO RIDE ON THE LOAD LINE, LOAD, OR BOOM OF THIS CRANE.
12. IT IS UNLAWFUL TO OPERATE THIS EQUIPMENT WITHIN TEN FEET OF HIGH VOLTAGE LINE



THIS PAGE INTENTIONALLY LEFT BLANK



F1122-B
05/12/08

HOUSTON, TEXAS
FAX: (800) 824-5559 (USA & Canada)
FAX: (713) 688-6324
PHONE: (713) 688-5533
www.liftmoore.com

INTRODUCTION

This crane is a powerful machine designed to lift and move heavy loads. There are many hazards associated with these operations. Liftmoore has designed this crane to be as safe as possible but -

IT IS THE OPERATOR'S RESPONSIBILITY TO PREVENT ACCIDENTS!

This takes pre-planning, attention, and knowledge of basic principles and rules. Even if you have used similar cranes, reading this manual in its entirety will help prevent damage, injury, or even loss of life; benefits well worth the short amount of time it takes to read these pages.

REGULATORY AUTHORITY

Use of this crane is governed by OSHA 29 CFR 1910.180 and may be governed by other federal, state, or local regulations.

IT IS THE OPERATOR'S RESPONSIBILITY TO UNDERSTAND AND COMPLY WITH ALL APPLICABLE REGULATIONS GOVERNING THE OPERATION, INSPECTION, AND MAINTENANCE OF THIS CRANE.

Personnel should be trained, tested, and certified, as recommended by OSHA and ANSI standards, before operating this crane.

USING THIS MANUAL

This manual assumes that the crane is mounted on a typical service body type or similar truck, which is powered by the vehicle electrical or hydraulic system, and is controlled by either the standard pendant control or FM radio control sold by Liftmoore, Inc.

This manual is supplied to provide basic guidelines for the safe use, routine maintenance, and general inspections of this crane.

Laws, regulations, standards, or policies may be more restrictive than this manual. If a conflict exists for any limit or condition, the safest or most prohibitive shall be used. Under no circumstances shall the load, moment, or stability ratings be exceeded.

Pay particular attention to the following:

WARNING! – Draws attention to hazards, conditions, or procedures that if not observed could result in injury or death.

CAUTION! – Draws attention to hazards, conditions, or procedures that if not observed could result in damage to the crane, load, or other equipment. Equipment failure could in turn lead to injury or death.

NOTE! – Draws attention to conditions or procedures that are essential to emphasize.

For questions, interpretations, or to report errors, please contact Liftmoore, Inc, Engineering Dept.



OPERATING PRACTICES

OPERATING RESTRICTIONS

DUTY CYCLE

For Electric Cranes the duty cycle time should be limited to 10%. This is limited by heat buildup in the motors and declining charge in the batteries. (Installing extra batteries near the crane helps keep the voltage at maximum.)

PERSONNEL

LIFTING OR MOVING OF PERSONNEL IS STRICTLY PROHIBITED! This crane was neither designed nor intended to lift personnel. Under no circumstances should anyone be allowed to ride on the crane, line, or load. All non-essential personnel must be kept away when using the crane. The load must never be moved over people, nor must anyone be allowed to pass or stand under a suspended load.

ELECTRICAL LINES

Consult ANSI B30.5 for operating procedures, minimum safe distances, and prohibited zones when working around electrical lines or poles.

When operating near electrical power lines, the crane must be positioned so that the distance from the crane to the lines or poles is equal to or greater than the length of the fully extended boom plus the minimum safe distance required.

All parts of the crane, line, and load must be kept a minimum safe distance from electrical power lines and poles. This distance is 10 feet for electrical lines carrying 50kV or less.

UNDER NO CIRCUMSTANCES SHOULD A CRANE BE OPERATED UNDER ELECTRICAL POWER LINES.

SETUP

POSITION The vehicle must be positioned so that the load is kept as close to the crane base as possible to reduce the moment on the crane. Consideration must be given to starting and ending position as well as firmness and slope of the ground and any obstructions.

OUTRIGGERS The outriggers or jack-stands must be firmly set and the vehicle as level as possible. This will reduce the stresses on the rotation drive and keep the load off the vehicle's suspension. Keep in mind that the weight on the vehicle will shift as the crane and load is rotated.

MANUAL BOOM EXTENSION If the manual extension part of the boom is needed, it must be extended and the boom pin placed in the required position. Insert the pin and replace the pin's hairpin keeper before attempting to lift any load.

LOAD LIMIT The operator must understand the crane load chart. The operator must ensure that the load is within the load limits over the entire range which it will be moved. Be sure to include the weight of any lifting devices including the travel block.

The load limit chart is attached to the side of the crane to aid the operator.

The boom angle indicator and chart aids the operator in determining the load capacity at various boom angles and extensions. It also gives the load limit at that configuration.

STABILITY A stability chart must be posted near the crane. The operator must understand the stability chart. The crane may be de-rated over some areas of its operating radius.



TRAVEL BLOCK The operator must determine if the load is within the single line compatibility of the winch or if a multi-part line configuration is needed.

REEVING Ensure the proper routing of the rope through the sheaves and travel block. The rope must lie in the sheave groove and must not rub against any metal objects.

Ensure the rope is correctly wound on the winch drum. The crane assembly drawing will indicate if the rope must be wound over the top or bottom of the drum. The rope must never contact any part of the winch mounting.

WARNING!

If the winch winding direction is reversed the brake will not work and the load will fall.

CRANE POWER

Before operating the crane turn ON power switch (Normally located under the crane) and twist to release E-Stop switch.

Push in E-Stop switch to turn OFF when the crane is no longer in use. Twist to release, hydraulic will not function if E-Stop is engaged.

ATTACHING THE LOAD

POSITION The boom tip must be moved over the load before lifting so that it will be lifted straight up.

CAUTION!

Never drag a load with the crane. Dragging a load puts very high stresses on the crane for which it was not designed.

ROPE Check the rope condition to ensure it is not frayed or damaged. Ensure that the rope is not kinked and that it does not contact any sharp edges or make any sharp bends.

If using double line configuration, ensure that the lines are not twisted.

CAUTION!

Never wrap the hoist rope around the load! Serious damage to the rope WILL occur.

HOOK Always make sure the load is applied to the throat of the hook. Never use a bent hook.

CAUTION!

Always lift with the throat of the hook. Never lift with the load applied to the tip of the hook. Doing so will bend the hook.

SLINGS If the load does not have a lifting eye, use a nylon, chain, or other type of sling designed for lifting and rated for loads greater than that being lifted.

BALANCE Ensure the load will be secure and balanced when lifted. Ensure that the load cannot shift in the sling and that the sling cannot slide across the hook should the load become unbalanced.



LIFTING THE LOAD

Before lifting, ensure that the load is free from all mountings and is no way attached or stuck to anything.

Ensure that at least five full wraps remain on the winch drum at all times.

Test the winch brake by lifting the load a few inches and ensuring that it does not slip.

HOLDING THE LOAD

The operator must keep the load in sight at all times once it is lifted.

The operator must never leave the controls once the load is lifted.

The operator must ensure that no one is allowed to pass or stand under a suspended load.

CAUTION!

Never move the vehicle with a suspended load. Doing so will put dynamic loads on the crane for which it was not designed.

MOVING THE LOAD

Before moving the load, make sure the path is free of any obstructions or people.

Avoid sudden accelerations or stops. Speeds must be kept to a minimum, especially rotation, to keep the load from swinging.

Avoid sudden reversing of direction. Do not reverse direction while the load is still moving.

Make sure that no part of the crane, boom, or load makes contact with any obstruction or comes within a minimum of ten feet from any electrical line.

TRANSIT

While in transit, the crane must be stowed, preferably in a boom rest. The crane must be prevented from rotating and the hook prevented from swinging.



INSPECTION AND MAINTENANCE

OSHA and ANSI require frequent and periodic inspections. Records of these inspections must be kept readily available. Liftmoore requires periodic maintenance to ensure proper operation and prolonged life of the crane.

INSPECTION

DAILY INSPECTION

OSHA 29CFR 1910.180 (d)(2)(i) requires the following be checked daily prior to use:

- All control mechanisms for maladjustment interfering with proper operation as well as for excessive wear of components and contamination by lubricants or other foreign matter.
- All safety devices for malfunction. This should include the anti-two block and pressure switch.
- Deterioration or leakage in air or hydraulic systems.
- Crane hooks with deformations or cracks. For hooks with cracks or having more than 15 percent in excess of normal throat opening or more than 10 deg. twist from the plane of the unbent hook.
- Electrical apparatus for malfunctioning, signs of excessive deterioration, dirt, and moisture accumulation. This should include the battery terminals, master disconnect switch, electrical swivel
- The wire rope shall be replaced if any of the following conditions are noted:
 - Kinking, crushing, bird-caging, or other damage

- Reductions from nominal diameter of more than one-sixty-fourth inch for diameters up to and including five-sixteenths inch, one-thirty-second inch for diameters three-eighths inch to and including one-half inch.
- Thimble is not in place or is damaged
- Any evidence of heat damage
- Six or more randomly distributed broken wires in 1 lay
- Three or more broken wires in 1 strand in 1 lay

MONTHLY INSPECTION

A thorough inspection of all ropes in use shall be made at least once a month and a certification record which includes the date of inspection, the signature of the person who performed the inspection and an identifier for the ropes shall be prepared and kept on file where readily available. All inspections shall be performed by an appointed or authorized person. Any deterioration, resulting in appreciable loss of original strength shall be carefully observed and determination made as to whether further use of the rope would constitute a safety hazard. Some of the conditions that could result in an appreciable loss of strength are the following:

- Reduction of rope diameter below nominal diameter due to loss of core support, internal or external corrosion, or wear of outside wires.
- A number of broken outside wires and the degree of distribution of concentration of such broken wires.
- Worn outside wires.



- Corroded or broken wires at end connections.
- Corroded, cracked, bent, worn, or improperly applied end connections.
- Severe kinking, crushing, cutting, or unstranding.

PERIODIC INSPECTION

An Annual Inspection Form is included in this manual. OSHA 29CFR 1910.180 (d)(2)ii) requires periodic inspections of this crane. Liftmoore recommends an annual inspection using the included form.

MAINTENANCE PRECAUTIONS

Before any maintenance is performed, the vehicle should be out of the way and the crane secured.

WARNING!

Never perform any maintenance while the crane has any type of load on it. Use the manual operation procedure to lower the load if necessary.

WARNING!

Hydraulic cylinders may have high pressure stored in them even after hydraulic power is removed.

The counterbalance and pilot operated check valve in the cylinder will always hold some pressure in the cylinder. Slightly extending the cylinder then retracting a small amount will relieve most of the pressure in the cylinder. **DO NOT DEADHEAD THE CYLINDER!** This will store the maximum amount of pressure in the cylinder. Care should be taken when either valve is removed from the cylinder as some pressure will still remain.

After any maintenance has been performed the crane shall not be operated until all guards have been reinstalled, all safety devices reactivated, and maintenance equipment removed.

LUBRICATION Refer to the crane specification section for the periodic maintenance schedule and type of lubrication required.

BOLTS Bolts may loosen over time due to vibration; therefore they should be checked periodically. If bolts need to be replaced, make sure they are replaced with bolts of equal or greater strength. Check the periodic maintenance schedule (Crane Specification Section) for bolt specification and torque.

NOTE!

Sheave and boom and cylinder pivot bolts are not standard bolts. The shank and thread length of these bolts have been modified so that they do not pivot on the threads. Consult the parts section of this manual for part numbers of these bolts.

OTHER MAINTENANCE

Refer to parts drawings for any specific maintenance or adjustment procedures such as hydraulic winch brake, rotation drive gear set adjustment, ect.



MONTHLY INSPECTION REPORT

Crane Model No. _____ Serial Number _____

| | | |
|--|-----------|----------|
| Are Boom Hitch Pins and Keepers in place? | Yes _____ | No _____ |
| Wire Line Hook with Safety Latch Working? | Yes _____ | No _____ |
| Is Hook OK, (Not bent)? | Yes _____ | No _____ |
| Is Thimble on Wire Rope OK? | Yes _____ | No _____ |
| Is Traveling Block in use? | Yes _____ | No _____ |
| Is Wire Rope OK, not kinked or frayed? | Yes _____ | No _____ |
| Are all Boom Sections straight? | Yes _____ | No _____ |
| Are Sheave Bolts in place and tight? | Yes _____ | No _____ |
| Do all Sheaves rotate easily? | Yes _____ | No _____ |
| Are Mounting Bolts tight? | Yes _____ | No _____ |
| Is Anti Two-Block functioning properly? | Yes _____ | No _____ |
| Is Boom Angle Indicator in place and functioning and is Chart legible? | Yes _____ | No _____ |
| Are Cylinder Mounting Bolts secure? | Yes _____ | No _____ |
| Are Winch Mounting Bolts tight? | Yes _____ | No _____ |
| When stopped does winch drift less than 1.0 Inches? | Yes _____ | No _____ |
| Is Load Chart in place and easily read? | Yes _____ | No _____ |
| Are functions on Pendant operating correctly? | Yes _____ | No _____ |
| Is Hydraulic Reservoir full? | Yes _____ | No _____ |
| Is Outrigger straight and functioning? | Yes _____ | No _____ |

Any items checked 'No' must be repaired before using this crane.



F1123-B
03/26/07

HOUSTON, TEXAS
 FAX: (800) 824-5559 (USA & Canada)
 FAX: (713) 688-6324
 PHONE: (713) 688-5533
www.liftmoore.com

THIS PAGE INTENTIONALLY LEFT BLANK



HOUSTON, TEXAS
FAX: (800) 824-5559 (USA & Canada)
FAX: (713) 688-6324
PHONE: (713) 688-5533
www.liftmoore.com

PROPORTIONAL PENDANT CONTROL SYSTEM

(WIRED OR FM)

Liftmoore cranes are electrically controlled using the hand-held pendant, which works in conjunction with the crane control module to operate powered functions and precisely regulate speed.

PENDANT - WIRED

All user inputs are facilitated by the remote pendant control. The pendant consists of pistol grip housing, wire, and control plug. The control plug mates with the crane control socket. The control socket is usually mounted on the valve cover. Optionally, the socket may be mounted below the crane with wires installed through the crane's base.

The pistol grip housing contains an on/off switch, one momentary contact switch for each function, and a trigger for regulating speed.

CRANE CONTROL MODULE

The crane control module contains the proportional valve driver and the limiting system control. It consists of a single printed circuit board enclosed in a rugged, sealed housing. Status LEDs are located on the circuit board to aid in troubleshooting.

The proportional valve driver supplies a regulated voltage to the pendant trigger, interprets the signal returned from the trigger, and then outputs an appropriate signal to the proportional valve.

The limiting system control is part of the safety system. Refer to that section for more information.

OPERATION

Plug the pendant into the crane control socket. Ensure all pins are straight and free of dirt, moisture, and corrosion. Turn the

locking ring approximately 1/3 turn until it clicks into the locked position.

Turn the pendant control switch on.

Select the function switch and direction as indicated on the label for the desired operation.

WARNING!

Never pull the trigger before operating the selection switch. Doing so will cause sudden acceleration and uncontrolled motion of the load.

SLOWLY squeeze the trigger until the desired speed is reached. Do not operate the function any faster than necessary. Be especially careful when rotating loads to prevent swinging.

When stopping, slowly release the trigger before releasing the function switch.

CARE AND MAINTENANCE

The pendant control is designed to be as rugged and maintenance free as possible; however, care should be used in handling and storage as it is expensive to replace.

Follow these simple practices:

- Keep the pendant out of the weather
- When not in use, store the pendant inside the vehicle
- Do not wrap the wire too tightly as internal damage to the wires may result
- Do not place sharp or heavy object on the cord

NOTE!

The pendant is designed to be weatherproof not waterproof. It may be used in inclement weather, but if left outside or where water can puddle, water can seep inside.

Maintenance should be limited to routine inspection of the plug, wire, and fasteners.



SAFETY SYSTEM

The safety system is designed to help prevent damage to the crane that would be caused by overload or two-blocking. The system consists of a load sensor, anti-two block device (optional on smaller, electric cranes), and limiting system control board.

When the applicable switch detects an overload or two-block condition, the limiting system will prevent activation of winch up, boom down, and extend out since these directions would cause damage. Winch down, boom up, extend in, and power rotation will still function so that the crane can be moved to a safe configuration.

CAUTION!

Never de-activate or override safety functions. Doing so can result in serious damage to the crane and possibly injury or death.

LOAD SENSOR

A pressure activated switch in the elevation cylinder acts as a load sensor. This switch is normally closed and opens at the preset pressure corresponding to the load rating of the crane.

CAUTION!

The load sensor will not function when the elevation cylinder is fully retracted and is inaccurate when the boom is below horizontal.

CAUTION!

The operator must never rely strictly on the load sensor to determine overload conditions. The load and load limits must always be known and adhered to.

ANTI-TWO BLOCK

The anti-two block device (optional on smaller electric cranes), mounted on the boom crown plate, consists of a normally open switch actuated by a lever. A weight is attached to the lever and holds the switch

closed. If the weight is lifted by the hook or travel block the switch opens.

The power and signal wires are wired through the cord reel, which is in turn wired to the ATB switch.

LIMITING SYSTEM CONTROL

The limiting system control prevents output of winch up, boom down and extend out if it is not receiving a signal from either the ATB or load sensor.

The ATB does not trip boom down when winch is mounted on the boom.

There is a one second delay before deactivation of boom down when the load sensor is tripped to prevent false readings caused by pressure spikes.

MISCELLANEOUS

UP LIMIT SWITCH

The up limit switch prevents the elevation cylinder from reaching full extension. If the elevation cylinder were to "dead-head", the resulting pressure would activate the load sensor, preventing boom down. The boom would then have to be lowered using the manual operation buttons on the solenoid valves.

CIRCUIT BREAKER, FUSE

For electric cranes a 150 Amp circuit breaker is supplied with the crane. It should be installed as close to the battery as possible. For hydraulic cranes a 10 Amp blade type fuse is supplied.

DISCONNECT SWITCH

A power disconnect switch is supplied with the crane. Power to the crane should be turned off whenever not in use. This is to prevent inadvertent or unauthorized use and will help prevent corrosion at electrical connections.



HYDRAULIC SYSTEM

Integrated Hyd Proportional

The hydraulic system consists of the hydraulic swivel, manifold with solenoid valves, cylinders, motors, and tubing and hoses. Hydraulic power is received from an external hydraulic source, typically a PTO driven pump attached to the vehicle transmission. The hydraulic system uses open center valves in series so that multiple functions can be operated simultaneously.

SWIVEL- (NOT USED IN 1032 OR 1640)

The hydraulic swivel is a two-port swivel that allows continuous, unlimited rotation. Refer to drawing for more information.

MANIFOLD - DWG 50771

The hydraulic manifold consists of a differential pressure sensing flow control valve, the system relief valve, proportional flow control valve, and 4 way directional control valves.

The Logic valve is a pilot operated pressure compensated flow control cartridge valve. It supplies the required flow to the manifold and returns excess flow to the tank so that pressure drop and heat build up are minimized.

The system relief valve prevents damage that would be caused by excessive pressure in the system. It is a cartridge type valve. Factory setting is 2800PSI.

The proportional valve is an electrically operated flow control valve. It allows the operator to control the flow, and therefore the speed, of the selected functions. The flow output is directly proportional to the electrical input. The valve may be operated manually by depressing the manual operation button on the top of the valve.

Each hydraulically operated function is controlled by a 4 way, 3 position open center solenoid valve. It is electrically operated and spring biased to center. A manual operation button is incorporated in the coil retaining nut.

CYLINDERS

Hydraulic cylinders are double acting cylinders with integrally mounted counterbalance valve and pilot operated check valves. Refer to the cylinder drawings for specific information.

All cylinders use a counter-balance load holding cartridge valve on the extend port. This valve performs 3 functions:

- Controls the rate of decent when lowering the load
- Keeps load from falling in the event of sudden loss of system pressure, such as when a hose bursts.
- Acts as a relief valve to prevent damage from induced load or thermal expansion.

It allows free flow to extend then blocks flow until opened by pilot pressure to the retract port or when the relief pressure is reached.

Some cylinders utilize a pilot operated check valve on the retract port to prevent the cylinder from creeping out under no load conditions. This valve allows flow into, but prevents flow from the retract port, thus hydraulically locking the cylinder until opened by pilot pressure to the extend port.

MOTORS

The hydraulic motors used by the rotation drive and hydraulic winch are high torque, low speed constant displacement motor.



MANUAL OPERATION

If electrical problems occur the solenoid valves may be operated manually. Refer to the manifold drawing for function valves and directions.

Directional control valves are manually operated by depressing the boot at the end of the valve. Use a blunt object (e.g. bolt or screwdriver handle) to assist in the operation.

Proportional valves are operated with either a boot or a small screw. Depress the boot or turn the screw slowly while operating a function to determine optimum speed. Turning the screw all the way in will result in rapid crane movement.

If hydraulic power is lost while a load is suspended, the load may be lowered by decreasing the setting on the counterbalance valve. This should only be done in extreme cases. The valve must be reset before the crane is returned to use.

To decrease the setting, loosen the locknut on the valve, then slowly turn the adjustment stem **CLOCKWISE** until the load begins to lower. Count the number of turns so that the valve can be returned to its original setting.

Alternately, a pressure gage must be put on the retract port to adjust the setting so that approx. 1800 PSI is required to lower the boom with no load.

Test the setting by lifting a known load near the moment rating of the crane.



BASIC TROUBLESHOOTING

The following chart gives a quick reference to help identify and correct problems. Refer to the following pages for more detailed information.

| PROBLEM | PROBABLE CAUSE | CORRECTIVE ACTION |
|--|---|--|
| NO FUNCTIONS WORK | <p>Not receiving electrical power</p> <p>Not receiving hydraulic power</p> <p>Control problem</p> | <p>Check all connections Check all fuses and circuit breakers Check for electrical power at first electrical connection and trace back to crane</p> <p>Check flow from pump Deadhead cylinder and check pressure at pump</p> <p>See control section</p> |
| <p style="text-align: center;">FUNCTION NOT WORKING</p> <p style="text-align: center;">Boom down, winch up, extension out not working</p> <p style="text-align: center;">Boom down, winch down, extension in not working</p> <p style="text-align: center;">Other function not working</p> | <p>No signal from ATB or Load sensor (switch tripped, bad switch, bad wiring or not receiving power)</p> <p>Relay card malfunction</p> <p>Not receiving enough pressure</p> <p>Faulty wiring</p> <p>Valve coils bad</p> | <p>Check input signal to relay board if no signal, trace back to switch</p> <p>Check LEDs on board for error codes and outputs</p> <p>Deadhead cylinder and check pressure at pump Check differential pressure valve for contamination Check relief valve for proper setting and possible contamination</p> <p>Check all wiring for breaks or shorts Check all ground wires for good connection</p> <p>Check coil resistance</p> |
| <p style="text-align: center;">ALL FUNCTIONS SLOW</p> <p style="text-align: center;">* These items only apply to cranes with proportional control systems.</p> | <p>Not receiving enough flow</p> <p>* Low battery voltage</p> <p>* Proportional valve problem</p> <p>* Control problem</p> | <p>Check fluid levels Check all filters and any other restrictions</p> <p>Check with engine running Charge battery</p> <p>Try manual operation of proportional valve</p> <p>Check voltage at valve for approx. at min and max(see troubleshooting form for specific valves)</p> <p>See control section</p> |



CONTROL TROUBLESHOOTING CHART WIRE PENDANT

| | | |
|---|----------------------------------|---|
| No functions working | Not receiving power | <p>Check crane control socket Pin E ensure that it is receiving 12V</p> <p>With the plug disconnected, activate a function switch then check continuity between Pin E and the activated function/direction pin</p> <p>For example: activate Hoist Down and check for continuity between Pin E and Pin P</p> |
| One function not working | Faulty wiring/switch malfunction | With the plug disconnected, activate the function that is not working and check for continuity between Pin E and corresponding function pin |
| All functions slow (APPLIES TO PROPORTIONAL CRANES ONLY) | Trigger problem | Check Crane Control Module for Error Code 5 and Proportional Output |
| | Valve driver problem | Calibrate valve driver board |

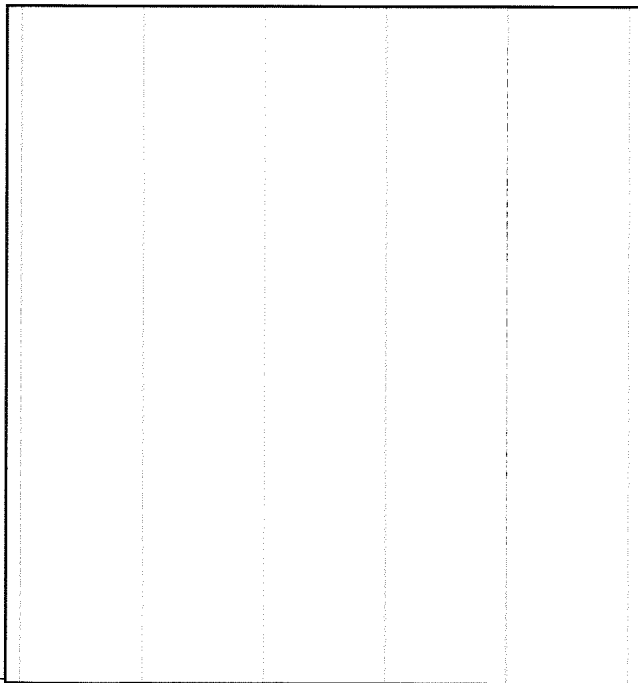

Figure 1 CONTROL PLUG ON PENDANT

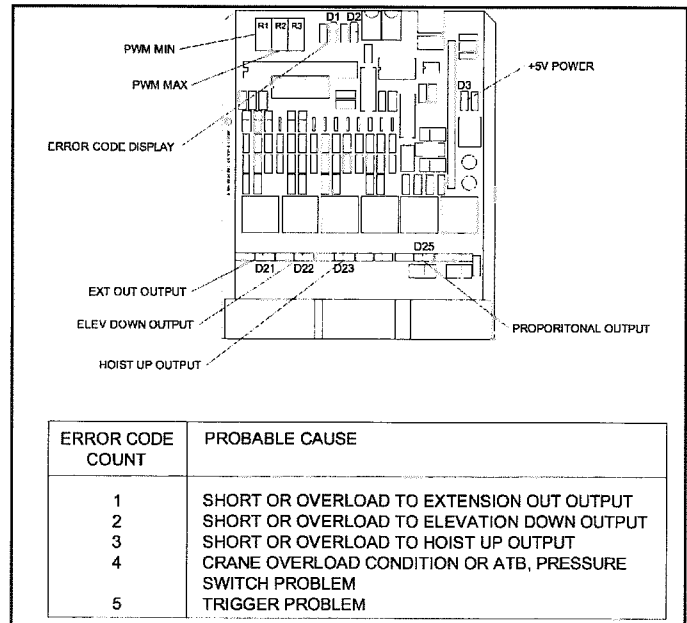

Figure 2 CRANE CONTROL MODULE

TROUBLESHOOTING SAFETY SYSTEM

DTCH Relay Card

To check functions controlled by the safety system check the status indicators. (See Relay Box Assembly drawing.) If only one of the safety functions is not working, activate that function and check for error codes and/or its output status indicator.

For non-FM systems, if the status indicator lights then the problem is in the wiring or in the solenoid coil. If the light does not illuminate, check the control pendant. If the control pendant is good then the crane control module needs to be replaced.

For FM systems, check for error codes. If none are present, see the FM Troubleshooting section.

If boom out, boom down and winch up are not working, confirm that the control board has power. Confirm that the board is receiving a signal from the ATB and load sensor.

If the error code is active, ensure that the crane is not overloaded and that the ATB lever is holding the switch closed. Check for voltage at the ATB and Load Sensor inputs.

CHECK LOAD SENSOR SWITCH

If the load sensor input is not receiving voltage, locate the load sensor connector inside the crane housing. The plug side will have a red wire and a gray wire, the receptacle side will have a red and a white wire.

Disconnect and check for continuity between the two pins on the receptacle (switch side). If there is no continuity then the load sensor is bad and needs to be replaced.

CHECK ATB SWITCH

If the ATB input is not receiving voltage remove the ATB housing cover and disconnect the connector. Check for continuity on the switch side. Lifting the weight should break the continuity. If either of these conditions is incorrect the switch is bad and needs to be replaced.

CHECK CORD REEL

Check the ATB switch if not done so already. Locate the ATB connector inside the crane housing. The plug side will have a red wire and a black wire. The receptacle side will have a white wire and a black wire.

Disconnect the plug going to the switch. Check for continuity between the two pins on the receptacle. Have someone lift the weight on the ATB and continuity should be broken. If either of these conditions are incorrect then the cord reel is bad and needs to be replaced.

CHECK POWER TO SAFETY SWITCHES

If the safety switch is good, check for voltage at pin 1 (the red wire) on the plug. If there is no voltage, follow the wire back to the 6-pin power distribution plug, checking for breaks or shorts.

Remove the power distribution receptacle (cap).

NOTE!

Removing the cap will disconnect power to all electrical components. Be sure to replace the cap before continuing.

Check the cap for bent pins. Check that all wires are fully seated in the plug. If they are not, then remove the green locking wedge and push the wires forward until seated. Reinstall the wedge ensuring that no wires are pushed back.



TROUBLESHOOTING THE PROPORTIONAL SYSTEM

21398 HALL EFFECT, 12V Diplomatic Coil

If no functions work or if all functions are slow when controlled by the pendant, but work correctly when the manual operation button is pressed on the proportional valve then the problem is with the proportional electronic control system.

Proportional Valve Parameters

| | |
|-------------------|-------|
| Cracking voltage | 2.6V |
| Full open voltage | 7.75V |
| Coil Resistance | 3.66Ω |

CHECK VOLTAGE AT VALVE

Have the engine running to generate sufficient voltage (13-14V). As the trigger is pulled the valve voltage should start near zero, jump to the valve cracking voltage after slight trigger travel, increase steadily as the trigger is pulled, reaching the full open voltage.

If the voltages are correct, check the resistance across the coil. If the resistance differs significantly from the nominal resistance replace the coil.

THE FOLLOWING APPLIES TO NON-FM CONTROL SYSTEMS ONLY. FOR FM SYSTEMS, REFER TO THE FM TROUBLESHOOTING SECTION OR CONTACT LIFTMOORE, INC FOR MORE INFORMATION.

VALVE DRIVER BOARD CALIBRATION

Refer to Relay Board Drawing .

Remove the relay board from the Deutsch box.

WARNING!

DO NOT allow board to contact any metal object.

Slightly pull the trigger (to obtain minimum voltage), hold, and use a screwdriver to turn R1 CCW to decrease- CW to increase. Next, fully pull the trigger (to obtain maximum voltage), hold, and turn R2 CCW to decrease- CW to increase. The voltage of R1 might change as R2 is changing or vice versa. Recheck the Min and the Max voltages. If voltage is correct, reassemble the board; otherwise, repeat.

If problem persists contact Liftmoore, Inc. for further instructions.



SECTION 3 CRANE SPECIFICATIONS

MODEL 1032 CRANES

MOMENT RATING 10 000 FT-LBS

MAX SINGLE LINE LOAD 1 600 LBS

MAX DOUBLE LINE LOAD 3 200 LBS

LIFTING CAPACITIES AT VARIOUS LOAD RADII

| LOAD RADIUS (FT) | CAPACITY (LBS) |
|---------------------|-------------------|
| <3.2 | 3200 |
| 5 | 2000 |
| 7 | 1429 |
| 9 | 1111 |
| 11 | 909 |
| 13 | 769 |
| 15 | 667 |

POWERED FUNCTIONS AND EXPECTED TIMES

| | | | |
|----------------|---------------|-----------------|--------------|
| WINCH | UP: 3 s | DOWN: 3 s | 1 REVOLUTION |
| BOOM ELEVATION | UP: 7.4 s | DOWN: 7.0 s | |
| BOOM EXTENSION | OUT: 12.2 s | IN: 11.8 s | |
| ROTATION | 90° 10.6 s | | |

HYDRAULIC REQUIREMENTS:

| | |
|----------|----------|
| PRESSURE | 2500 PSI |
| FLOW | 6 GPM |

ELECTRICAL REQUIREMENTS

| | |
|---------|--------|
| VOLTAGE | 12 VDC |
| FUSE | 15 AMP |

NOTE: FUNCTION TIMES ARE BASED ON THESE INPUT VALUES



F1642-0
01/20/10

HOUSTON, TEXAS
FAX: (800) 824-5559 (USA & Canada)
FAX: (713) 688-6324
PHONE: (713) 688-5533
www.liftmoore.com

| PERIODIC MAINTENANCE SCHEDULE | | |
|-------------------------------|--|--------------------------------|
| MODEL 1032 CRANES | | |
| BOLTS | | |
| MOUNTING BOLTS | 1/2-20 GRADE 8 TORQUE 120 FT-LBS DRY | EVERY 4 MONTHS |
| LUBRICATION | | |
| GREASE FITTINGS | SEE DRAWING 50460 | EVERY OTHER WEEK |
| HYDRAULIC FLUID | STANDARD Chevron AW Hydraulic Oil 46 or equivalent SAE 15 weight oil COLD WEATHER AW 32 or equivalent SAE 10 weight oil | CHECK DAILY, FILL AS NEEDED |
| ROTATION GEARBOX | Sunep 460 gear oil or AGMA Grade 7EP oil | EVERY MONTH |
| BEARING (ZERK AND TEETH) | Oil Center Research PM 600 Military grease or equivalent Benton Based Grease NLGI Grade 2 | EVERY 6 HOURS OF OPERATION |
| BOOM | Coat with "Slip Plate" made by Superior Graphite or similar solid lubricant coating | AS NEEDED |



F1642-0
01/20/10

HOUSTON, TEXAS
FAX: (800) 824-5559 (USA & Canada)
FAX: (713) 688-6324
PHONE: (713) 688-5533
www.liftmoore.com

CRANE LUBRICATION POINTS

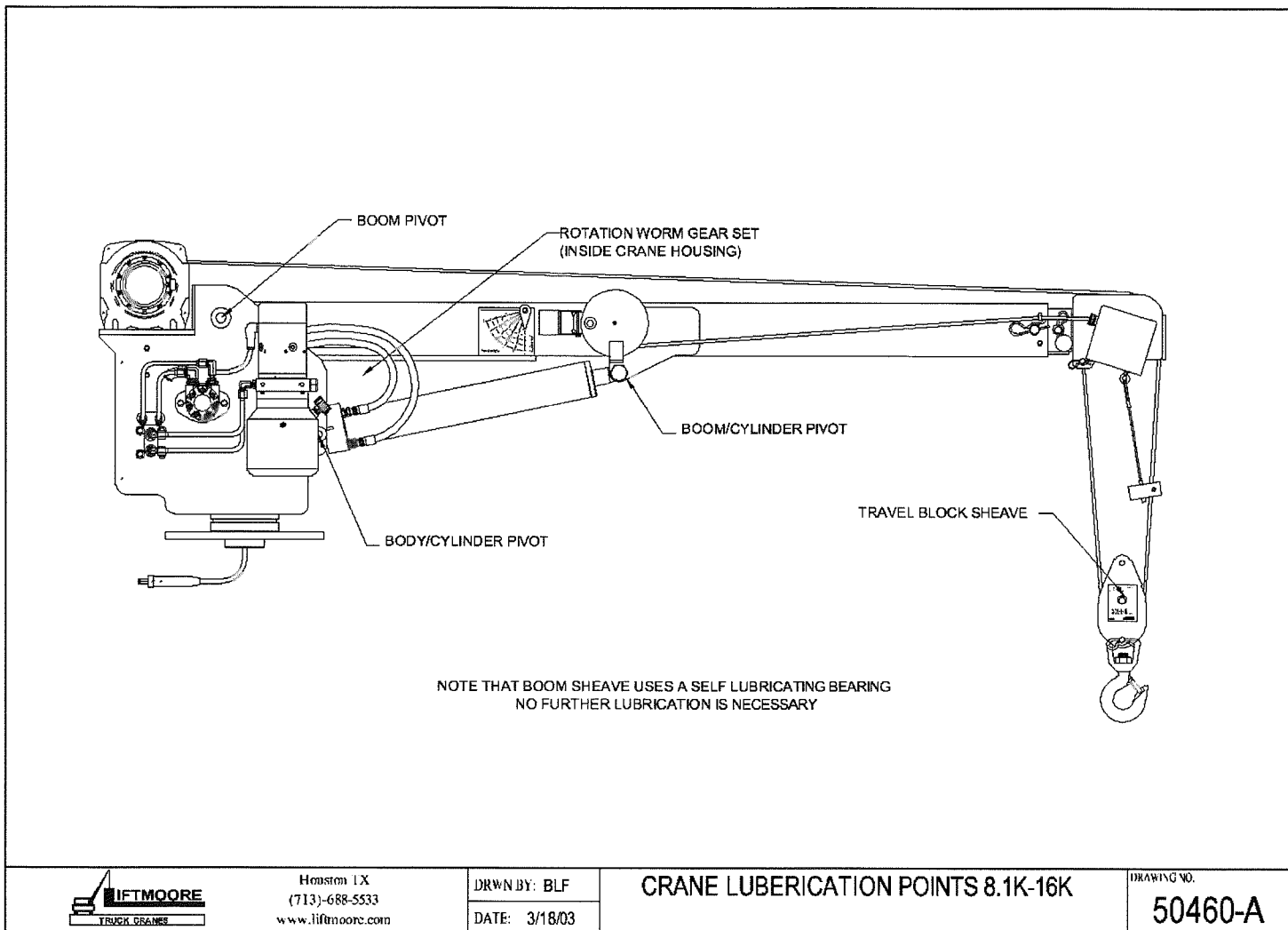

F1642-0
01/20/10

HOUSTON, TEXAS
 FAX: (800) 824-5559 (USA & Canada)
 FAX: (713) 688-6324
 PHONE: (713) 688-5533
www.liftmoore.com

THIS PAGE INTENTIONALLY LEFT BLANK



F1642-0
01/20/10

HOUSTON, TEXAS
FAX: (800) 824-5559 (USA & Canada)
FAX: (713) 688-6324
PHONE: (713) 688-5533
www.liftmoore.com

LIST FOR BOX, CRANE PARTS 1032XP

Items with * have detailed DWG's.

P/N 23947 - BOX, CRANE PARTS 1032XP-11
ATB LS; WINCH 19530; E-STOP

- 1) P/N 23948 - MANUAL, CRANE 1032XP-11.....1pc
- 2) P/N 21154 - FUSE, 30 AMP BLADE.....1pc
- 3) P/N 18457 - FUSE HOLDER, ATO 12GA SEALED.....1pc
- 4) P/N 19487 - CW, 10 GA X 300".....1pc
- 5) P/N 30760 - PIN, HITCH 0.75 X 4.50 W/H-PIN.....1pc
- 6) P/N 30815 - SCREW, HHC 0.50-13 X 2.50 GR8.....4pcs
- 7) P/N 30474 - WASHER, LOCK 0.50 GR5 PLATED.....4pcs
- 8) P/N 31957 - NUT, HEX 0.50-13 GR8 PLATED.....4pcs
- 9) *P/N 22556 - BLOCK, TRAV ASSY 3.2K lbs/4.0D.1pc
- 10) P/N 32613 - ADAPTER, 8MJ-10MJ.....1pc
- 11) P/N 32545 - ADAPTER, 6MP-8MJ.....1pc
- 12) P/N 32546 - ADAPTER, 6MP-10MJ.....1pc
- 13) P/N 31864 - ADAPTER, 6FP-6MP SWIVEL.....2pcs
- 14) P/N 17012 - SWITCH, TOGGLE SPST MAINT. /S.....1pc
- 15) P/N 17011 - BRACKET, SWITCH MNT. HYD. CRN.....1pc
- 16) P/N 16781 - TERMINAL, RING 10-12 GA #8.....2pcs
- 17) P/N 17013 - PLATE, ON-OFF FOR TOGGLE SWCH.....1pc
- 18) P/N 18600 - PLATE, CRANE-TRUCK STABILITY CHART.....1pc
- 19) P/N 22430 - INSTALLATION INTS. 1032.....1pc
- 20) P/N 22382 - DECAL, LOAD CAPACITY 10K-7-151pc



F1727-0
08/02/10

HOUSTON, TEXAS
FAX: (800) 824-5559 (USA & Canada)
FAX: (713) 688-6324
PHONE: (713) 688-5533
www.liftmoore.com

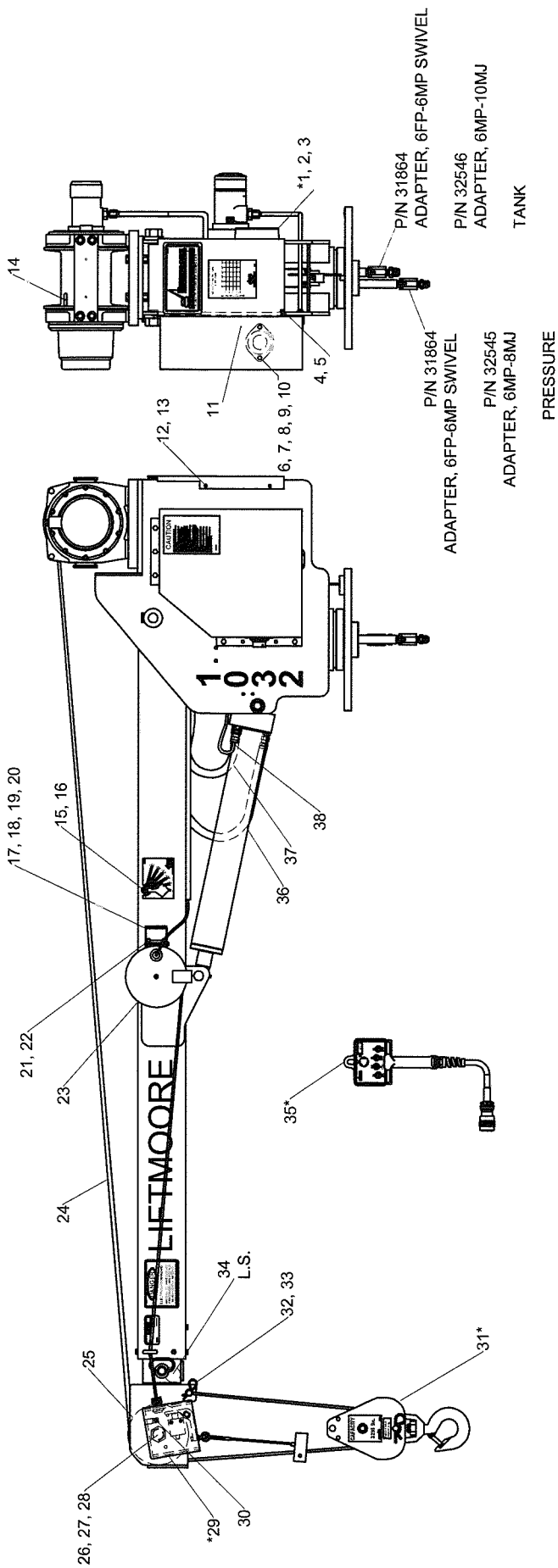

ITEMS WITH * HAVE DETAIL DRAWINGS

| # | PN | DESCRIPTION | QTY | # | PN | DESCRIPTION | QTY | # | PN | DESCRIPTION | QTY |
|----|-------|-------------------------------------|-----|----|-------|--------------------------------|-----|------------|--------------------------|--------------------------------|-----|
| 1 | 22570 | BOARD, RELAY 3RD G XP | 1 | 16 | 31017 | SCREW, SHOULDER 0.31-18 X 0.75 | 2 | 31 | 22556 | BLOCK, TRAV ASSY 3.2K lbs/4.0D | 1 |
| 2 | 17164 | SCREW, SOC HD 10-24 X 0.62 SS | 2 | 17 | 70012 | BRACKET, CORD REEL | 1 | 32 | 22553 | PIN, CLEVIS 0.56 X 2.5 PLATED | 1 |
| 3 | 32639 | WASHER, LOCK #10 GR2 PLATED | 2 | 18 | 30833 | NUT, HEX NYLOC 0.25-20 GR2 | 2 | 33 | 31603 | CLIP, HAIRPIN 0.50 - 0.62 | 1 |
| 4 | 31933 | SCREW, SOC HD 0.25-20 X 0.50 (GRND) | 1 | 19 | 31110 | WASHER, FLAT 0.25 GR5 PLATED | 2 | 34 | 31036 | STOP, BOOM INNER ASSY STD. | 1 |
| 5 | 30889 | WASHER, LOCK 0.25 GR5 PLATED | 1 | 20 | 30457 | SCREW, HHC 0.25-20 X 0.75 GR5 | 2 | 35 | 23793 | CONTROL, PENDANT XP HALL TRIG | 1 |
| 6 | 23584 | EWH, DTCH HYD 3RD G XP | 1 | 21 | 33410 | SCREW, MH RD 10-24 X 3.00 | 1 | 36 | 33975 | HOSE, HYD #6 47.00" | 1 |
| 7 | 30457 | SCREW, HHC 0.25-20 X 0.75 GR5 | 2 | 22 | 33409 | NUT, HEX NYLOC 10-24 GR2 | 1 | 37 | 33999 | HOSE, HYD #6 42.00" ST-ST | 1 |
| 8 | 31110 | WASHER, FLAT 0.25 GR5 PLATED | 2 | 23 | 20407 | REEL, CORD 20 FT ASSY DTCH | 1 | 38 | 21213 | SWITCH, PRES ASSY 1450PSI DTCH | 1 |
| 9 | 30889 | WASHER, LOCK 0.25 GR5 PLATED | 2 | 24 | 32895 | ROPE, WIRE 0.25 X 62' W/TB&LP | 1 | NOT SHOWN: | | | |
| 10 | 30830 | NUT, HEX 0.25-20 GR2 PLATED | 2 | 25 | 33058 | SHEAVE ASSY 5.90PD X 0.25 ROPE | 1 | 19847 | CONNECTOR, DTCH 2P PLUG | 1 | |
| 11 | 30889 | SCREW, HWHSMS #8 X 0.50 | 1 | 26 | 34468 | SCREW, SHEAVE SINGLE 1-8 3.25 | 1 | 19845 | CONNECTOR, DTCH 2P RECPT | 1 | |
| 12 | 32994 | COVER, BACK 3200 PLASTIC | 1 | 27 | 31258 | WASHER, FLAT 1.00 SAE GRADE 8 | 1 | 19846 | WEDGE, DEUTSCH 2P PLUG | 1 | |
| 13 | 32589 | SCREW, HWHSMS 0.25-20 X 0.75 | 4 | 28 | 30838 | NUT, HEX NYLOC 1.00-8 GRADE 5 | 1 | 19848 | WEDGE, DEUTSCH 2P RECPT | 1 | |
| 14 | 70041 | NUT, HEX 0.44-20 GR2 | 1 | 29 | 22908 | ATB ASSY, DEUTSCH CONNECTOR | 1 | 33025 | PLATE, SERIAL 3200/1032 | 1 | |
| 15 | 22394 | PENDULUM, LOAD RADIUS DIA. HD | 2 | 30 | 32957 | CLAMP, HOSE SUPPORT 0.62 ID | 1 | 21650 | DECAL KIT 1032 DTCH | 1 | |

Houston TX
(713)-688-5533
www.liftmoore.com

CRANE ASSY 1032XP-11 DTCH

ATB LS; WINCH 19530

DRAWING NO.
23946-0

DRWN BY: IS

DATE: 08/02/10

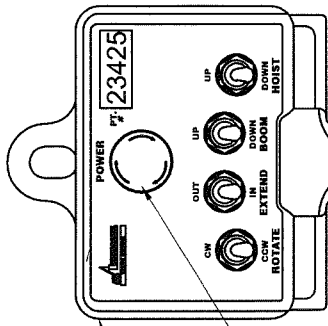

TERMINAL P.O MALE 14-16 GA P/N 32118
 P/N 15566
 TERMINAL P.O FEMALE 14-16 GA P/N 21399 - CONTROL, PENDANT XP HE HALL EFFECT TRIGGER, NO PLUG

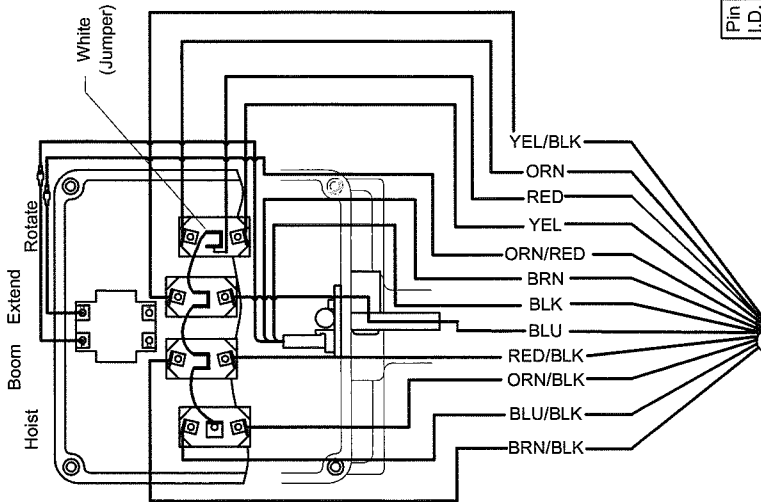
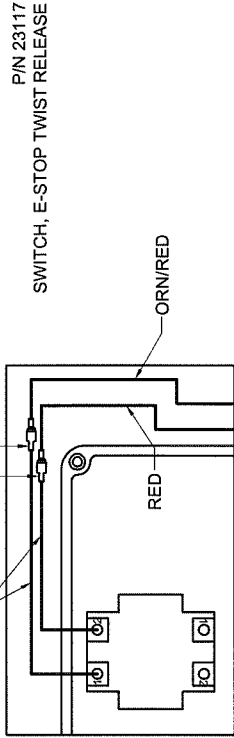

| Pin I.D. | Function | Color |
|----------|----------------|---------|
| A | TRIGGER PWR | ORN/RED |
| B | TRIGGER GRND | BLK |
| C | E-STOP | BLU/RED |
| D | E-STOP GRD. | BLK/RED |
| E | POWER | RED |
| F | ROATION CW | YEL |
| G | BOOM UP | RED/BLK |
| H | BOOM DWN | BRN/BLK |
| J | HOIST UP | ORN/BLK |
| K | TRIGGER SIGNAL | BRN |
| L | ROTATION CCW | ORN |
| M | EXTEND OUT | BLU |
| N | EXTEND IN | YEL/BLK |
| P | HOIST DOWN | BLU/BLK |

WIRE COLORS ARE FOR ORIGINAL PENDANT
 MADE WITH 16 CONDUCTOR CABLE.
 REPLACEMENT CABLES MAY HAVE
 DIFFERENT NUMBER OF CONDUCTORS
 AND DIFFERENT COLORS.
 CONTACT LIFTMOORE, INC IF COLOR CODE
 DOES NOT MATCH CURRENT CONDITION OF PENDANT.

P/N 22558
 CONNECTOR, CGB 3/4 NPT FLEX
 P/N 19976 - PLUG, CONTROL 14-PIN DEUTSCH KIT

DRAWING NO.
23793-A

CONTROL, PENDANT XP HALL TRIG
 HALL EFF. TRIGGER W/E-STOP

DRWN BY: JC
 DATE: 01/25/10

Houston TX
 (713)-688-5533
 www.liftmoore.com



| 3RD GENERATION RELAY BOARD | |
|----------------------------|-----------------------------|
| Pin No. | Description |
| 1 | Ground |
| 2 | No Connection |
| 3 | No Connection |
| 4 | Pressure Switch Input |
| 5 | ATB Switch Input |
| 6 | Winch Up Switch Input |
| 7 | Elevation Down Switch Input |
| 8 | Extension Out Switch Input |
| 9 | Extension Out Output |
| 10 | Elevation Down Output |
| 11 | Winch Up Output |
| 12 | Supply (9 To 30 VDC) |

ERROR CODE CHART

| ERROR CODE COUNT | PROBABLE CAUSE |
|------------------|---|
| 1 | No Input To ATB Switch Input |
| 2 | No Input To Pressure Switch Input Or Overload Condition |
| 3 | Short Or Overload To Winch Up Output |
| 4 | Short Or Overload To Elevation Down Output |
| 5 | Short Or Overload To Extension Out Output |
| 6 | Trigger Input Out Of Range |

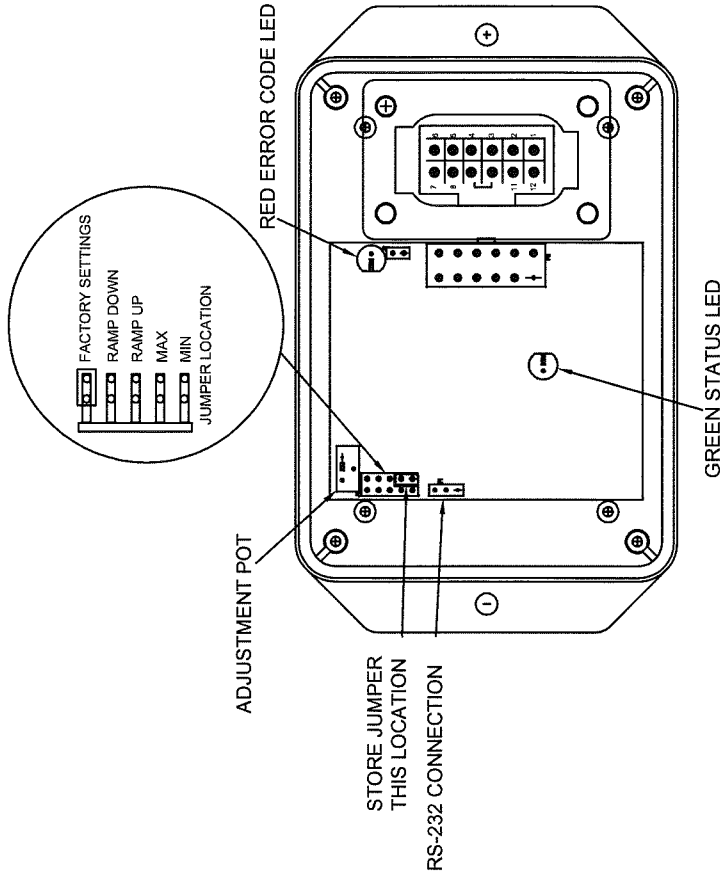

To Display an error code, the controller turns on and off the error code LED a certain number of times with a pause at the end. It repeats the code until the problem is resolved. The **Error Code Chart** is provided to assist the service personnel in troubleshooting the system.

Houston TX
(713)-688-5533
www.lifmoore.com

DRWN BY: JC
DATE: 06/11/07

BOARD, RELAY 3RD G XP
BOOM DOWN STOPPED BY ATB

DRAWING NO.

22570-0



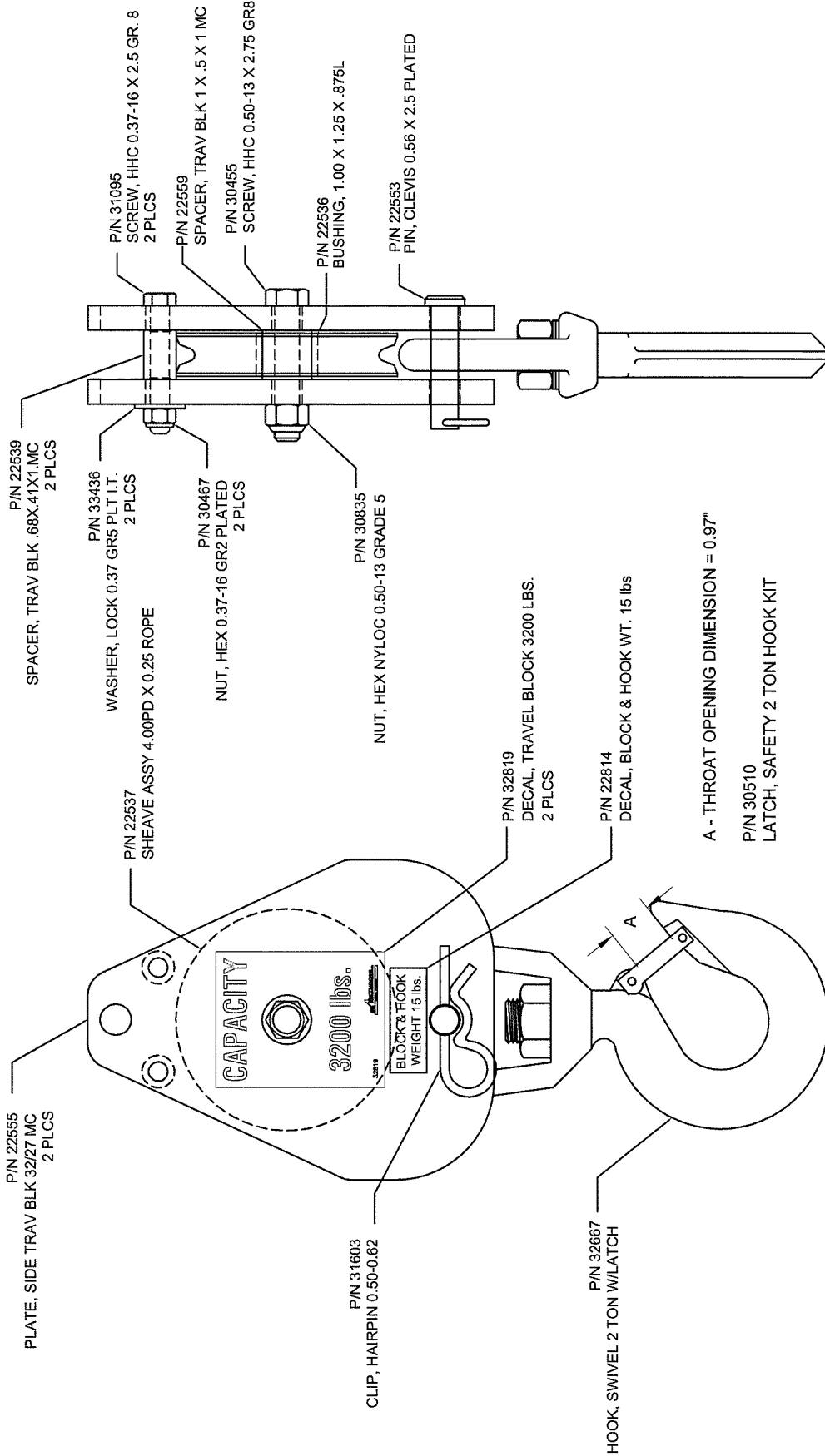

CAUTION:

NEVER USE A HOOK WHOSE THROAT OPENING HAS BEEN INCREASED, OR WHOSE TIP HAS BEEN BENT MORE THAN 10 DEGREES OUT OF PLANE FROM THE HOOK BODY, OR IS IN ANY WAY DISTORTED OR BENT.

| | | | | |
|--|--|------------------------------|--|-------------------------------|
| | Houston TX (713)-688-5533 www.iftmoore.com | DRWN BY: JC DATE: 6/23/08 | BLOCK, TRAV ASSY 3.2K lbs/4.0D 4.00PD X 0.25 ROPE; 3200 LBS | DRAWING NO. 22556-C |
|--|--|------------------------------|--|-------------------------------|

NOTE: WIRE SHOULD BE SECURED TO SHEAVE BOLT TO ENSURE THAT IT DOES NOT INTERFERE WITH THE LEVER

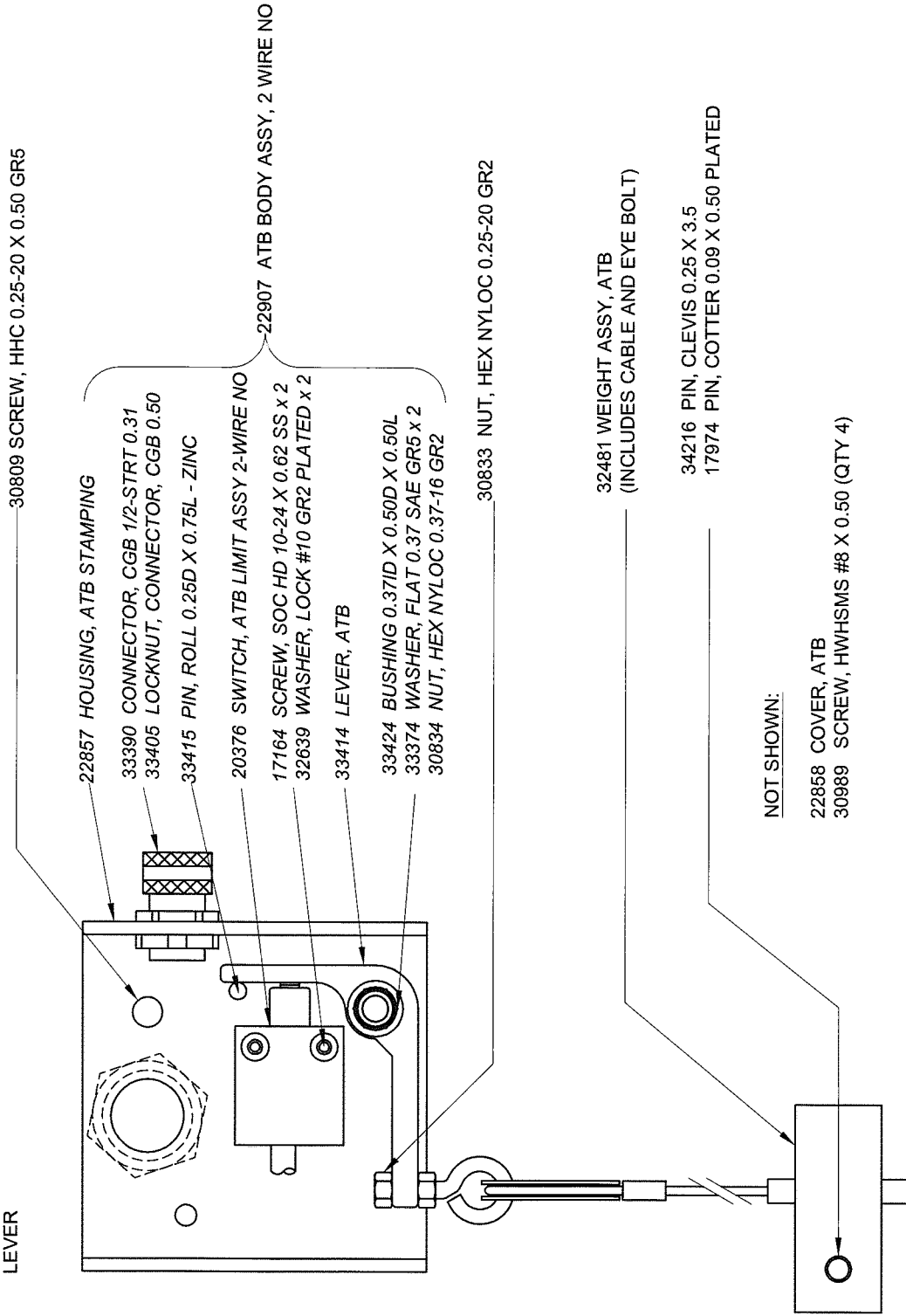

NOT SHOWN:

Houston TX
(713)-688-5533
www.iftmoore.com

DRWN BY: JC

DATE: 07/02/09

ATB ASSY, DEUTSCH CONN
TWO-WIRE NORMAL OPEN; LEFT SIDE

DRAWING NO.

22908-A



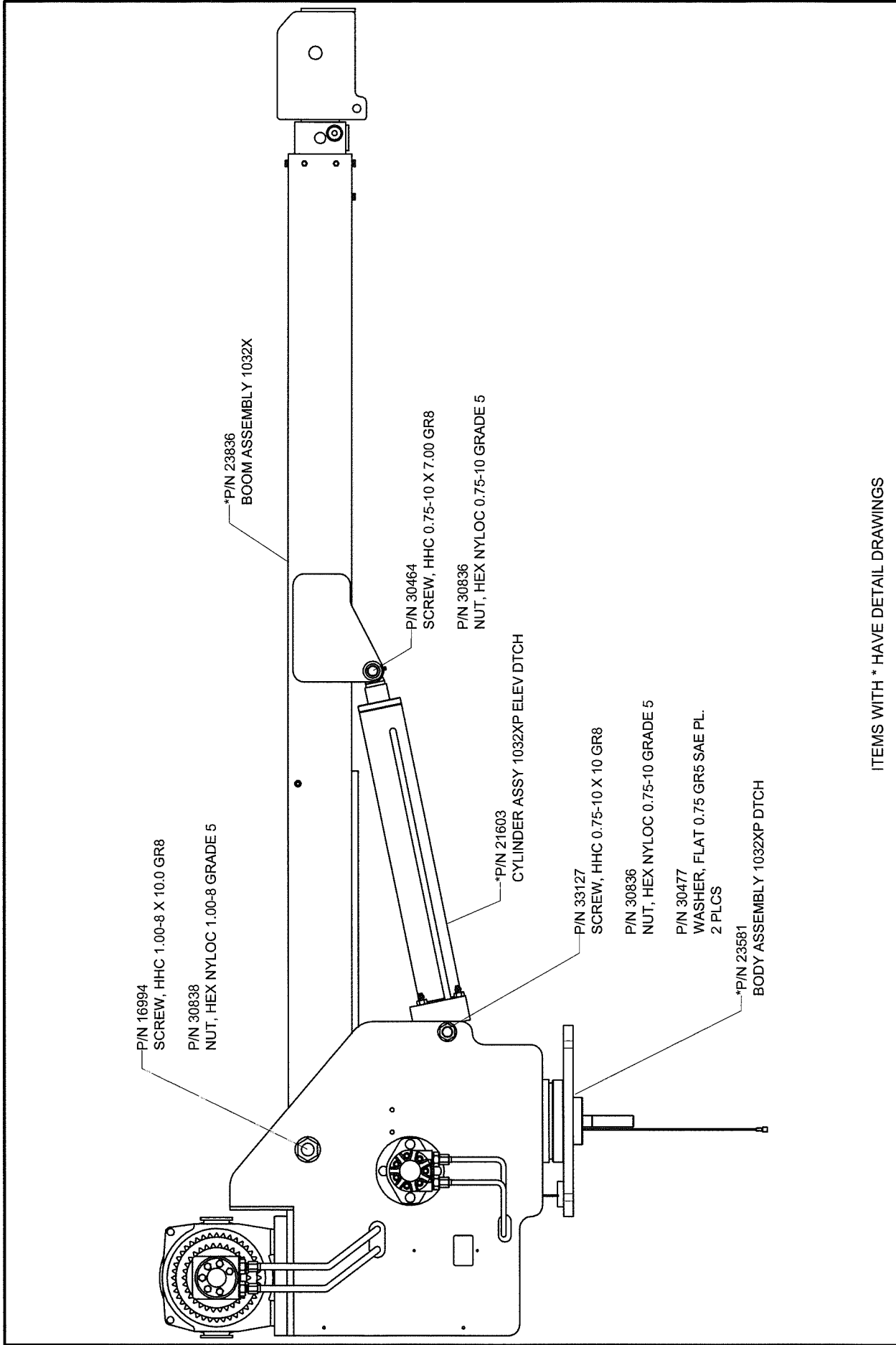

ITEMS WITH * HAVE DETAIL DRAWINGS

| | | | | |
|---|---|-------------------------------|--|-------------------------------|
|  | Houston TX (713)-688-5533 www.liftmoore.com | DRWN BY: IS DATE: 08/02/10 | BOOM-BODY ASSY 1032XP-11 DTCH ATB LS; WINCH 19530 | DRAWING NO. 23945-0 |
|---|---|-------------------------------|--|-------------------------------|

P/N 21213
SWITCH, PRES ASSY 1450PSI DTCH
(NOT PART OF ASSEMBLY)

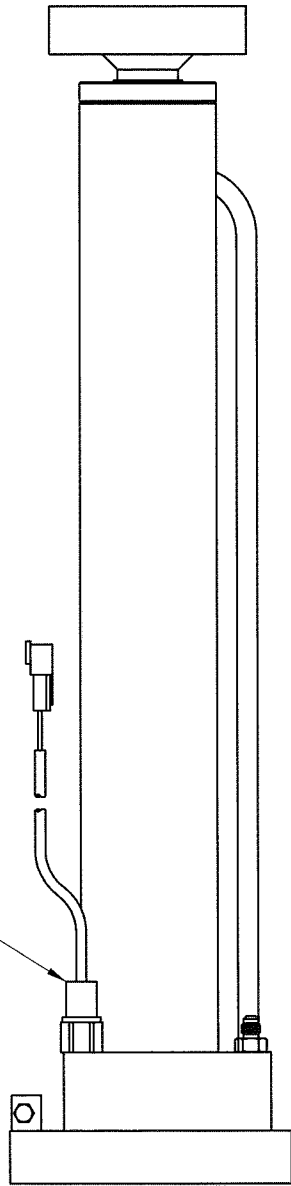

P/N 31063
ADAPTER, 6MJ-6MO
2 PLCS

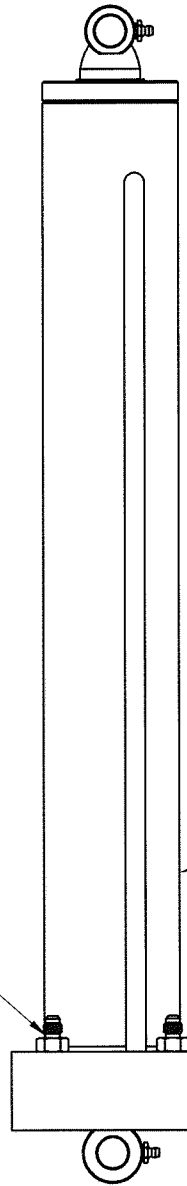

P/N 32867
CYLINDER, 3.0 X 18.5 X 1.25 PE

| REPLACEMENT PARTS FOR CYLINDER | |
|--------------------------------|---------------|
| DESCRIPTION | PART NUMBER |
| SEAL KIT | TM*SK-0000148 |
| COUNTER BALANCE VALVE | 30851 |

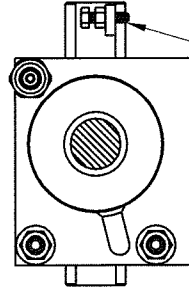

P/N 30810
SCREW, HHC 0.25-20 X 1.00 GR5

P/N 30830
NUT, HEX 0.25-20 GR2 PLATED

FOR UPLIMIT SWITCH

Houston TX
(713)-688-5533
www.liftmoore.com



CYLINDER ASSY 1032XP ELEV DTCH

DRAWING NO.

21603-A

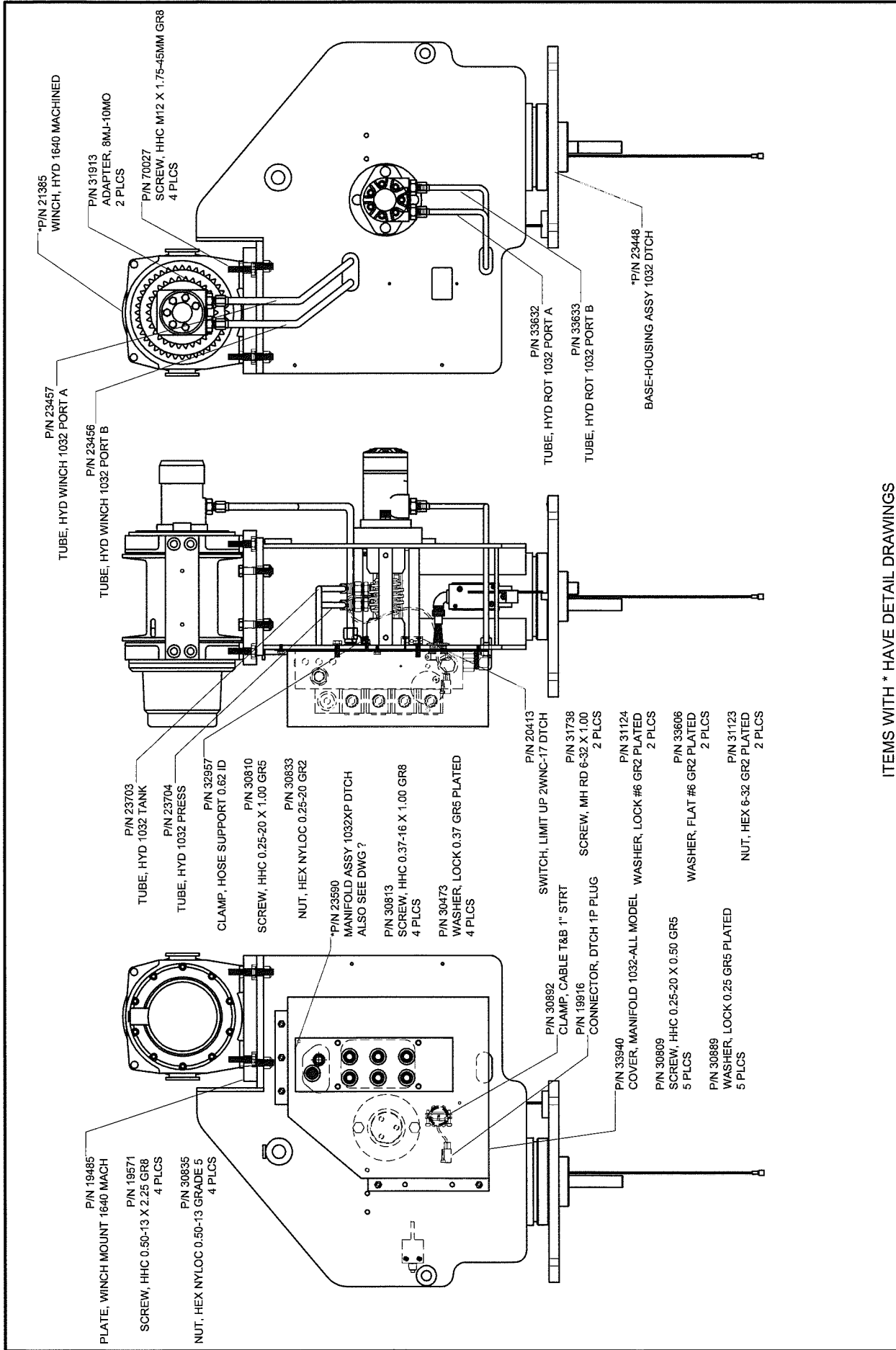

ITEMS WITH * HAVE DETAIL DRAWINGS

DRWN BY: JC
 DATE: 03/17/10

Houston TX
 (713)-688-5533
 www.liftmoore.com



BODY ASSEMBLY 1032XP DTCH
 USE WINCH P/N 19530; NEW MANIFOLD

DRAWING NO.
23581-0

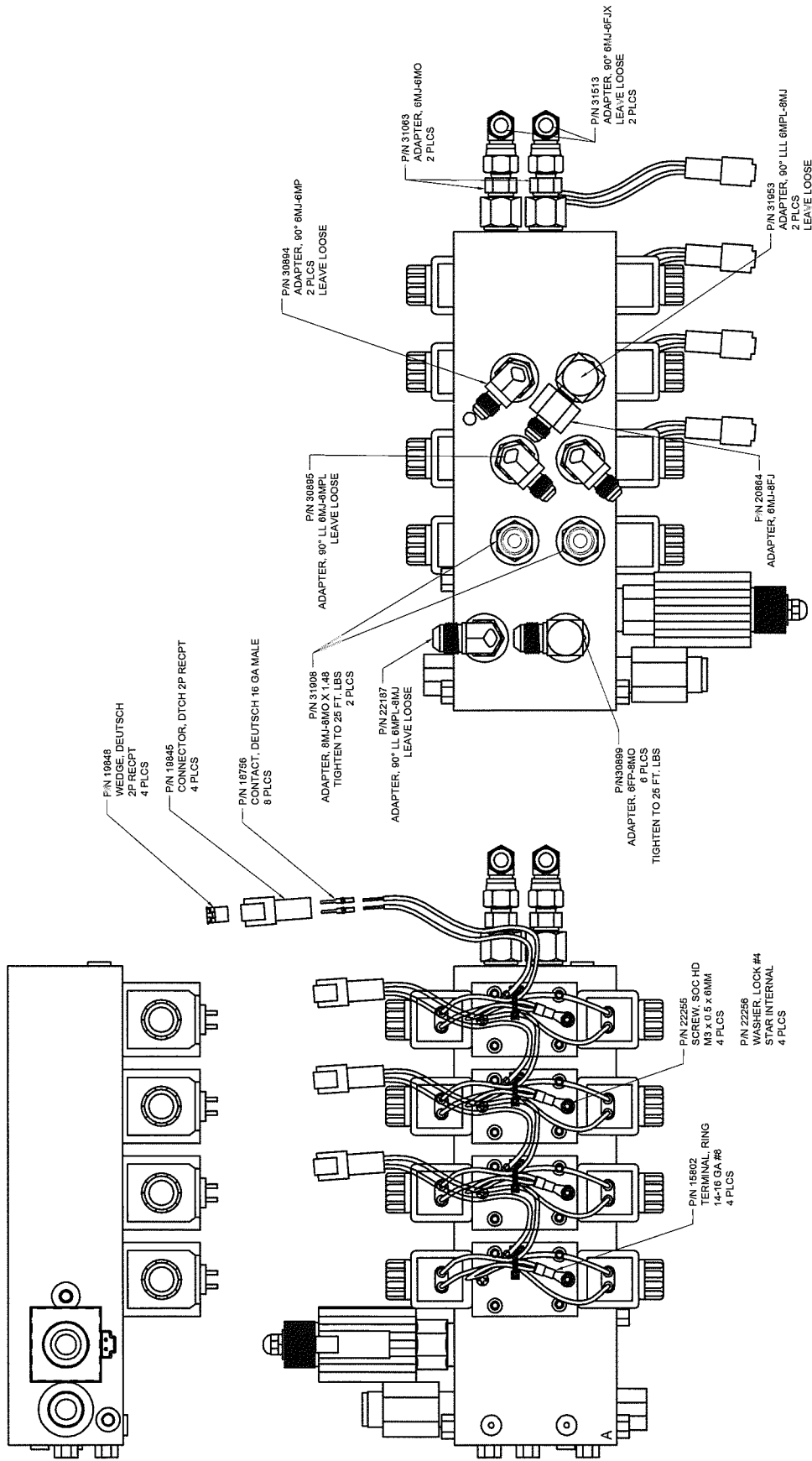

DRAWING NO.
23590-0

MANIFOLD ASSY 1032XP DTCH

DRWN BY: IS

DATE: 05/03/10

Houston TX
(713)-688-5533
www.liftmoore.com



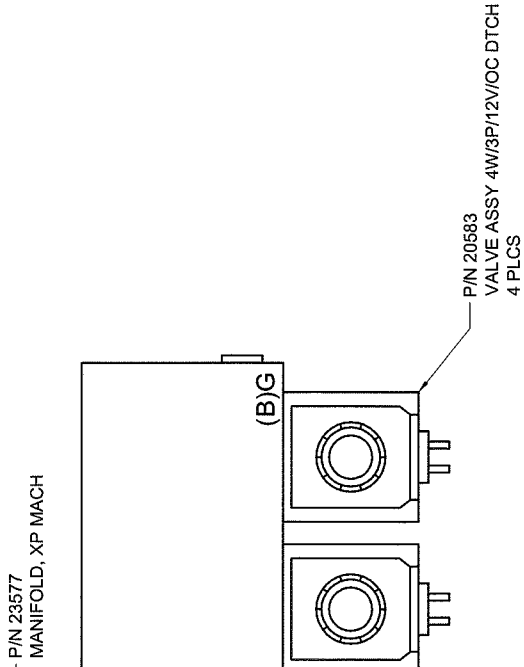

- ITEM NOT SHOWN:
 P/N 23610
 ORIFICE, 1/16-27NPT 0.040 ID
 P/N 20426
 EWH, PROP VALVE PLUG DTCH
 P/N 23602
 ORIFICE, 1/16-27NPT BLANK BR

P/N 20583
 VALVE ASSY 4W/3P/12V/OC DTCH
 4 PLCS

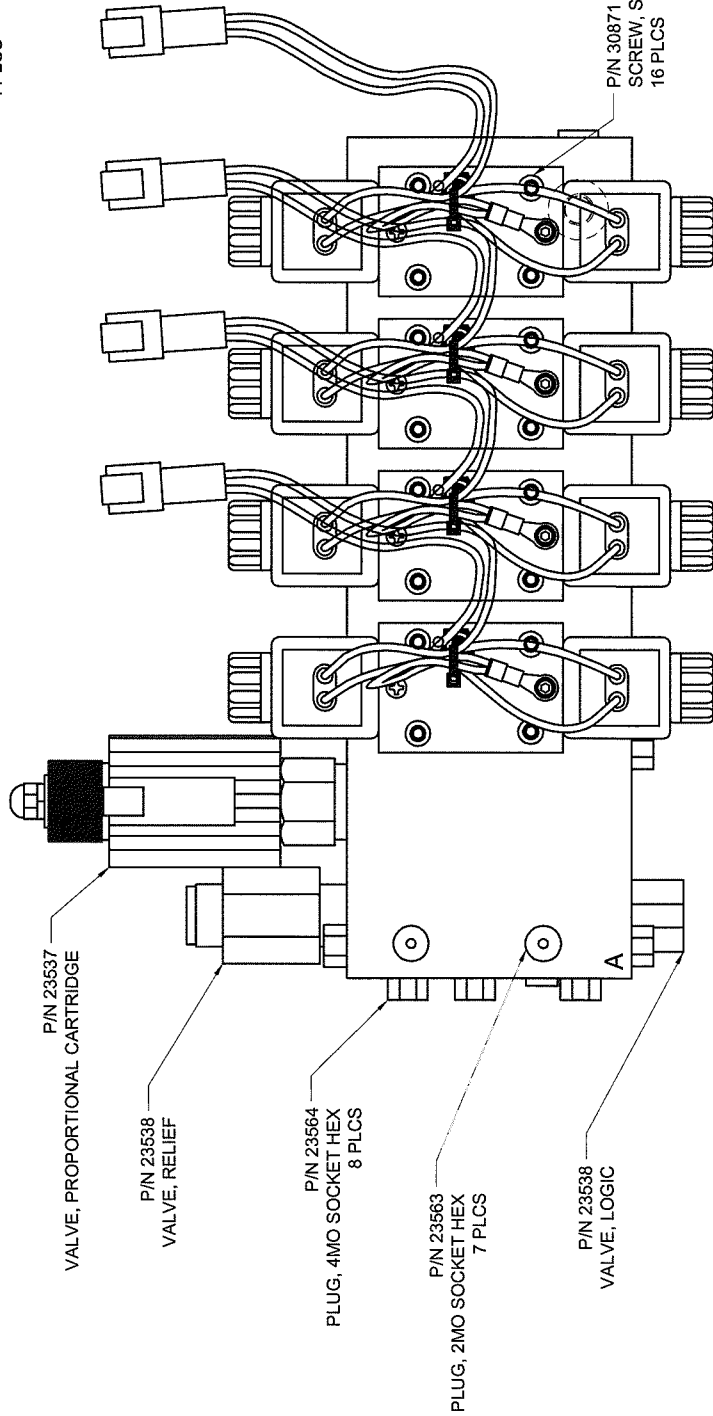

Houston TX
 (713)-688-5533
 www.liftmoore.com

DRWN BY: IS
 DATE: 4/30/10

MANIFOLD PRE-ASSY XP DTCH

DRAWING NO.
 23645-0



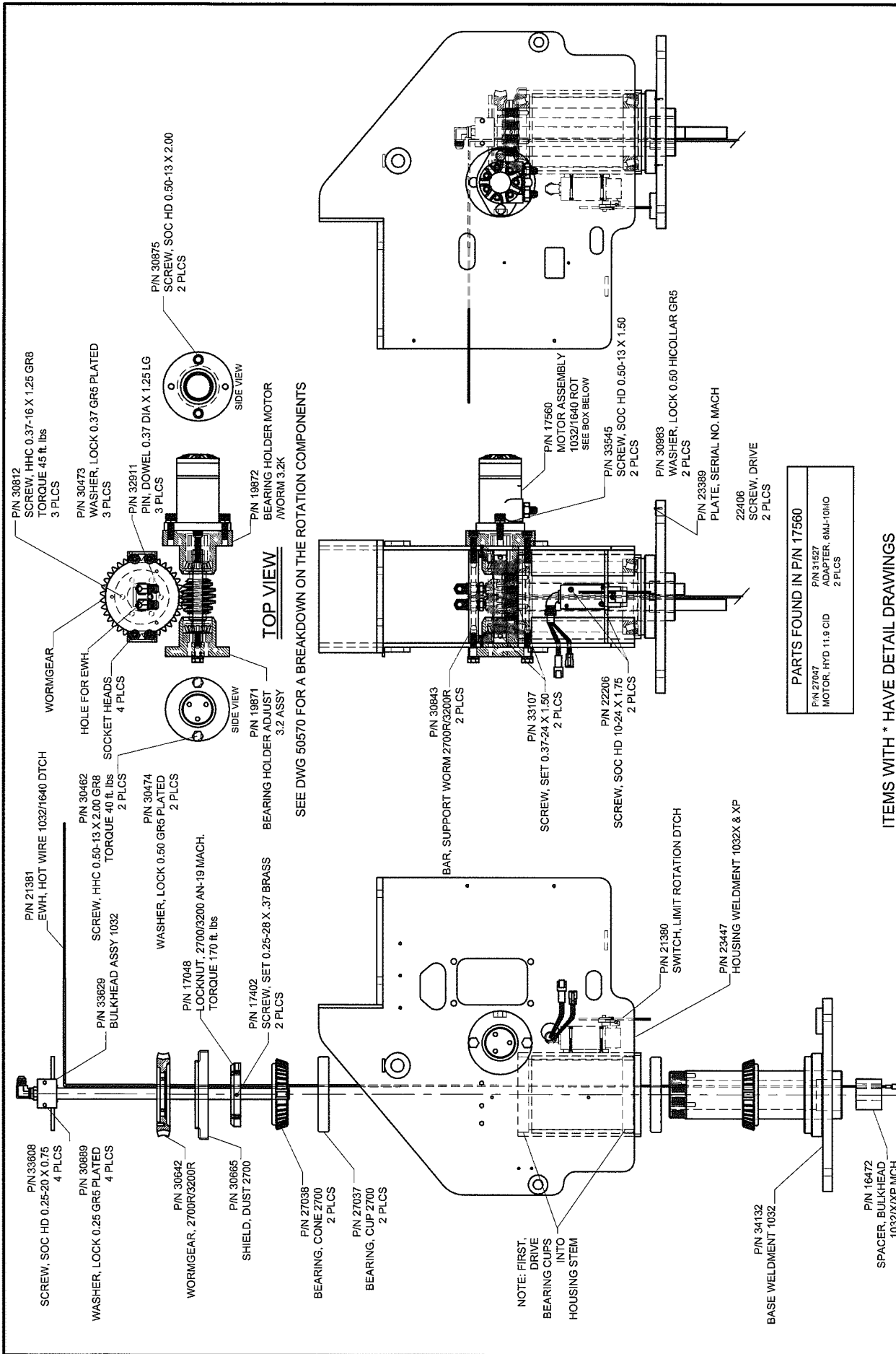

| PARTS FOUND IN P/N 17560 | |
|--------------------------|--------------------|
| PIN 27047 | PIN 51627 |
| MOTOR, HYD 11.9 CID | ADAPTER, 6MJ-10810 |
| | 2 PLCS |

ITEMS WITH * HAVE DETAIL DRAWINGS

| | | | | |
|--|---|-------------------------------|--|-------------------------------|
| | Houston TX (713)-688-5533 www.liftmoore.com | DRWN BY: JC DATE: 01/15/10 | BASE-HOUSING ASSY 1032 DTCH USE WINCH P/N 19530; 22209 RB | DRAWING NO. 23448-0 |
|--|---|-------------------------------|--|-------------------------------|

TO ADJUST BACKLASH BETWEEN GEARS:

LOOSEN MOUNTING BOLTS

MAKE SMALL ADJUSTMENTS TO THE BACKLASH ADJUSTMENT SCREWS, NO MORE THAN A 1/4 TURN. ALTERNATE BETWEEN SCREWS SO THAT ALIGNMENT IS MAINTAINED.

SOME PLAY **MUST** BE LEFT BETWEEN THE GEARS OR THE CRANE WILL NOT OPERATE PROPERLY AND EXCESSIVE WEAR AND/OR DAMAGE WILL OCCUR. INITIAL SETTING IS SUCH THAT THE RETRACTED BOOM TIP MOTION IS LESS THAN 1 INCH.

WHEN FINISHED, TORQUE THE MOUNTING BOLTS TO 40 FT-LBS

TO ADJUST PLAY IN WORM MOUNTING:

TIGHTEN THE 3 SET SCREWS IN THE BEARING HOLDER THEN BACK THEM OUT 1 TURN

SCREW THEM BACK IN JUST UNTIL THEY ARE SNUG. OVER TIGHTENING WILL PUT THE WORM AND MOTOR IN A BIND AND IT WILL NOT FUNCTION PROPERLY.

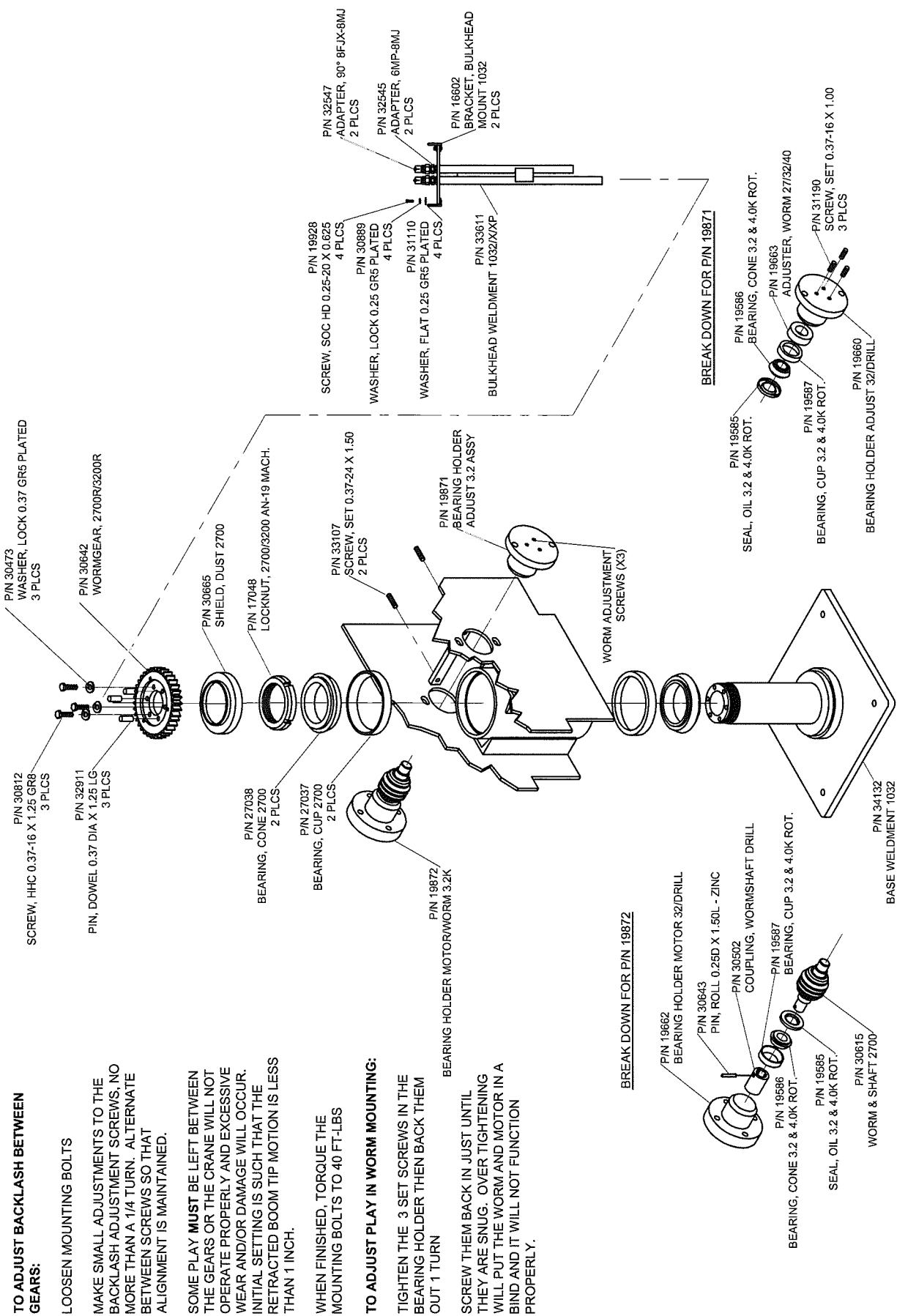

| | | | | |
|---|---|---|--------------------------|------------------------|
|  | Houston TX (713)-688-5533 www.liftmoore.com | DRWN BY: JC DATE: 02/23/10 | ROTATION COMPONENTS 1032 | DRAWING NO. 50570-B |
| | ROTATION COMPONENTS 1032 | | | |

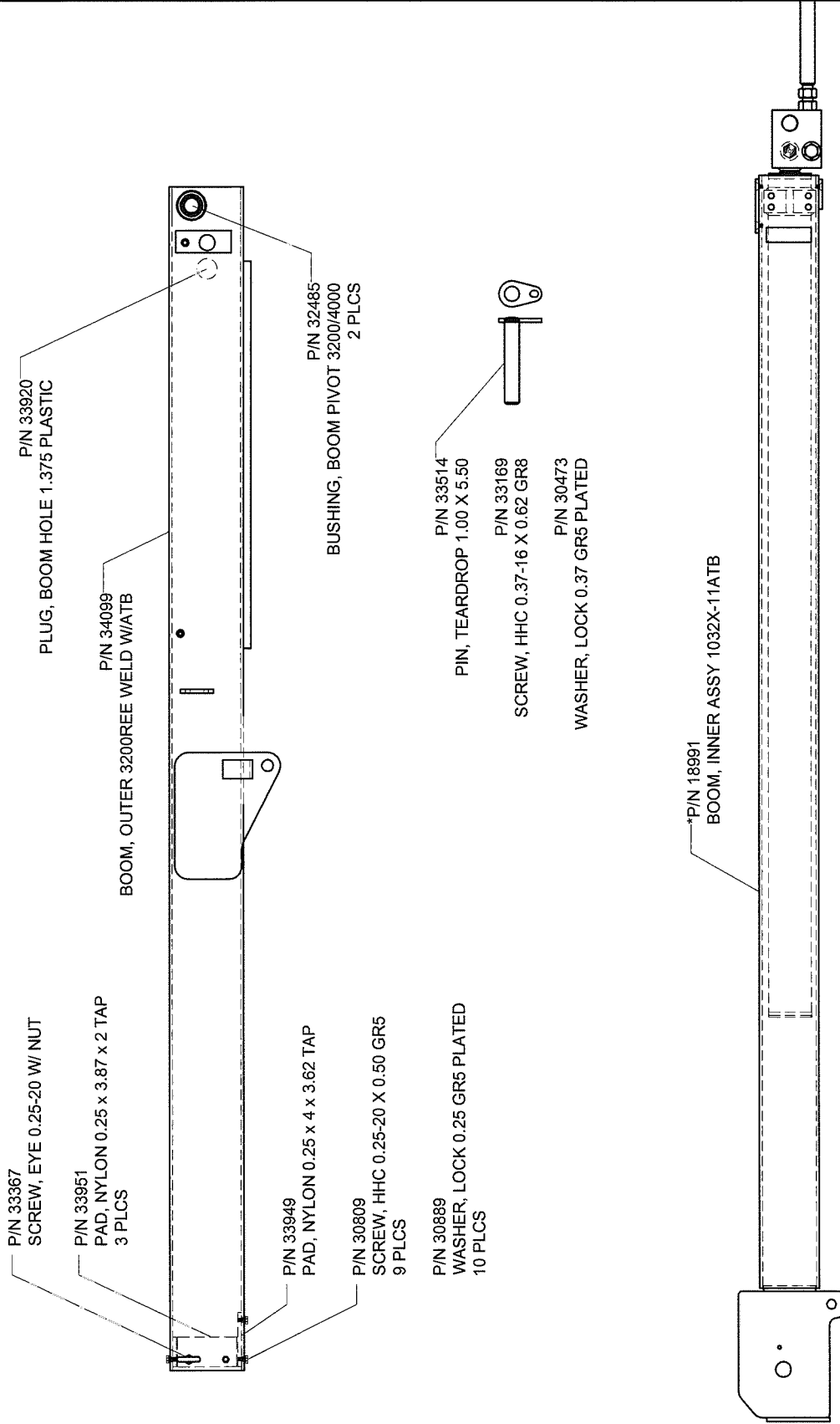

ITEMS WITH * HAVE DETAIL DRAWINGS

| | | | |
|--|----------------|---|-------------------------------|
| Houston TX (713)-688-5533 www.iftmoore.com | DRAWN BY: IS | BOOM ASSEMBLY 1032X-11 E-STOP; L.S. ATB; X MANIFOLD; RB 22209 | DRAWING NO. 23836-0 |
| | DATE: 06/29/10 | | |



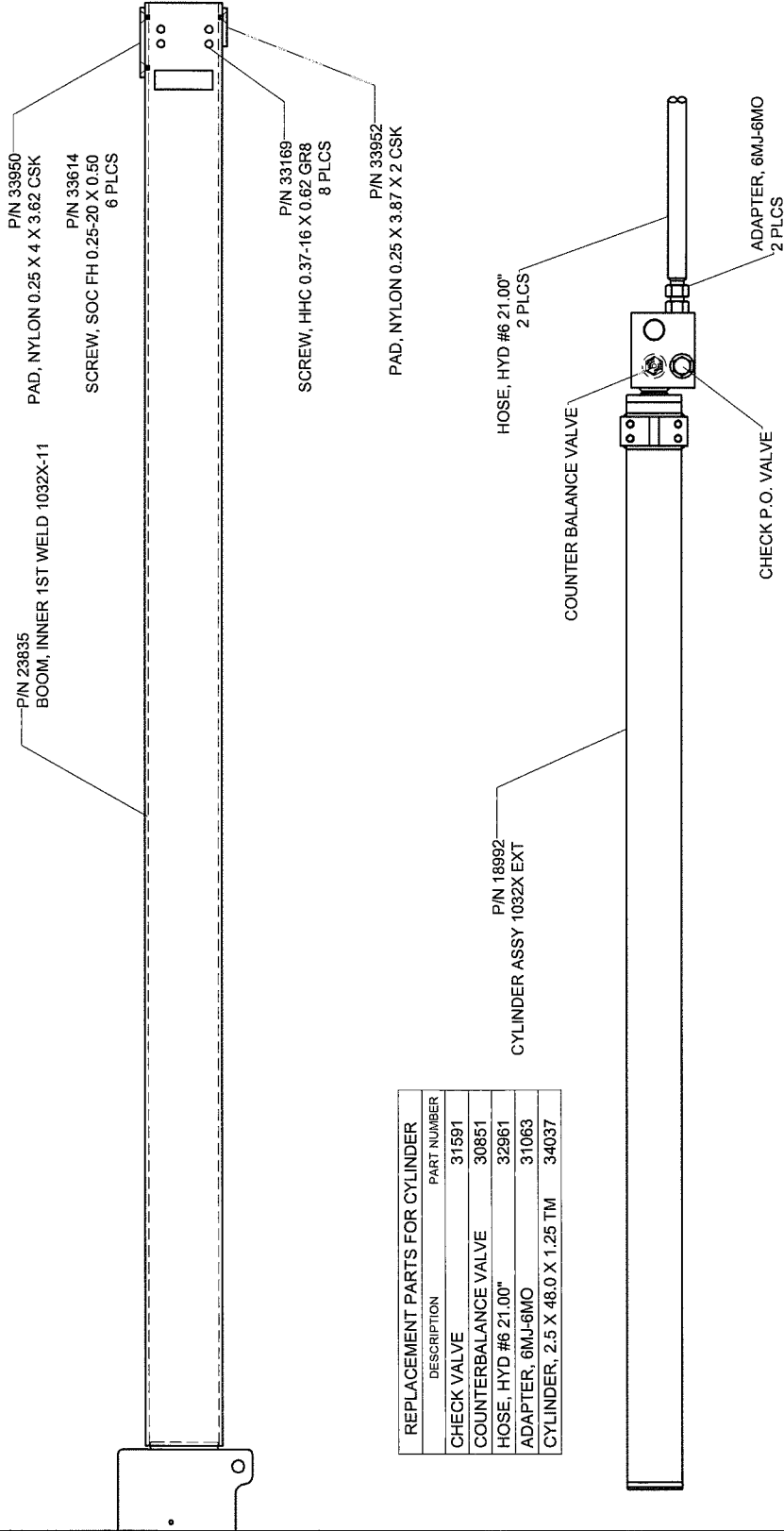

| REPLACEMENT PARTS FOR CYLINDER | |
|--------------------------------|-------------|
| DESCRIPTION | PART NUMBER |
| CHECK VALVE | 31591 |
| COUNTERBALANCE VALVE | 30851 |
| HOSE, HYD #6 21.00" | 32961 |
| ADAPTER, 6MJ-6MO | 31063 |
| CYLINDER, 2.5 X 48.0 X 1.25 TM | 34037 |

Houston TX
(713)-688-5533
www.iftmoore.com



BOOM, INNER ASSY 1032X-11
E-STOP; L.S. ATB; 23799 MANIFOLD; RB 22209

DRWN BY: IS
DATE: 06/29/10

DRAWING NO.

23838-0

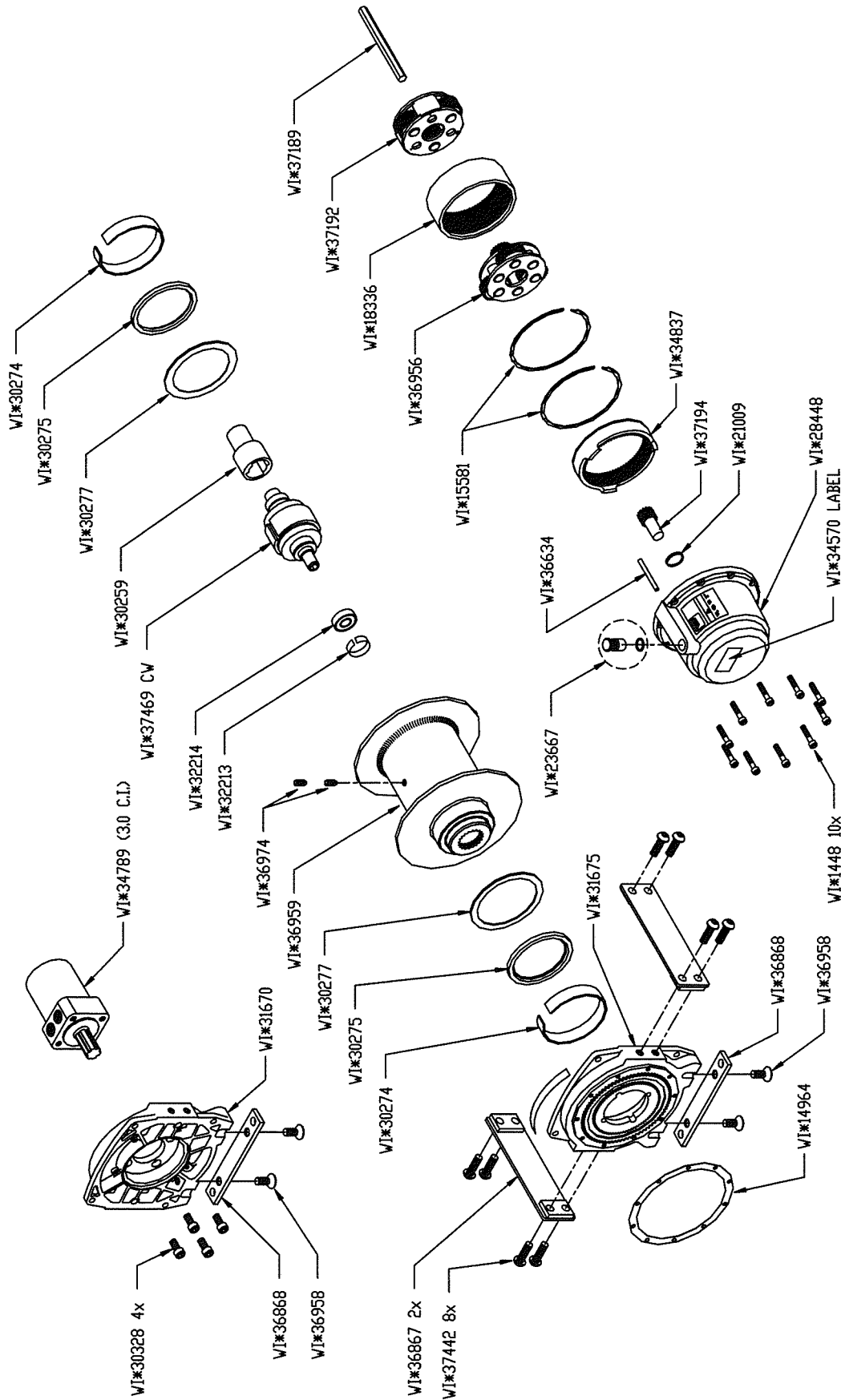

DRAWING NO.
50580-A

WINCH ASSY HYD DC3000
WINCH, HYD 1640 WINCH

DRWN BY: JC
DATE: 9/02/08

Houston TX
(713)-688-5533
www.lifmoore.com



THIS SCHEMATIC IS USED FOR EWH's 23584.

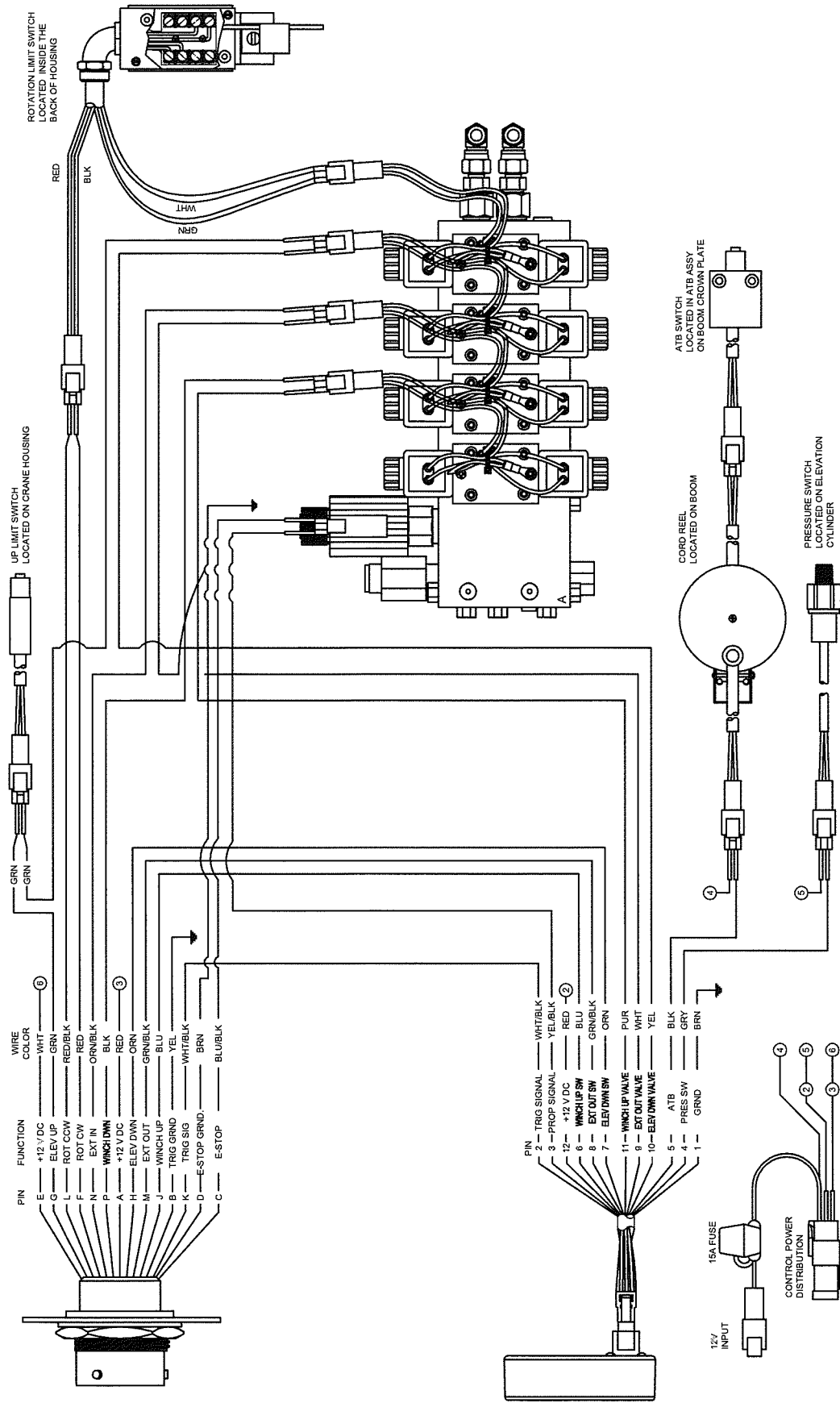

DRAWING NO.
50768-0

SCHEM, ELEC WIRING DTCH 3RD G XP E-STOP
ROTATION SWITCH, 1032/1640

DRWN BY: JC
DATE: 03/24/10

Houston TX
(713)-688-5533
www.liftmoore.com



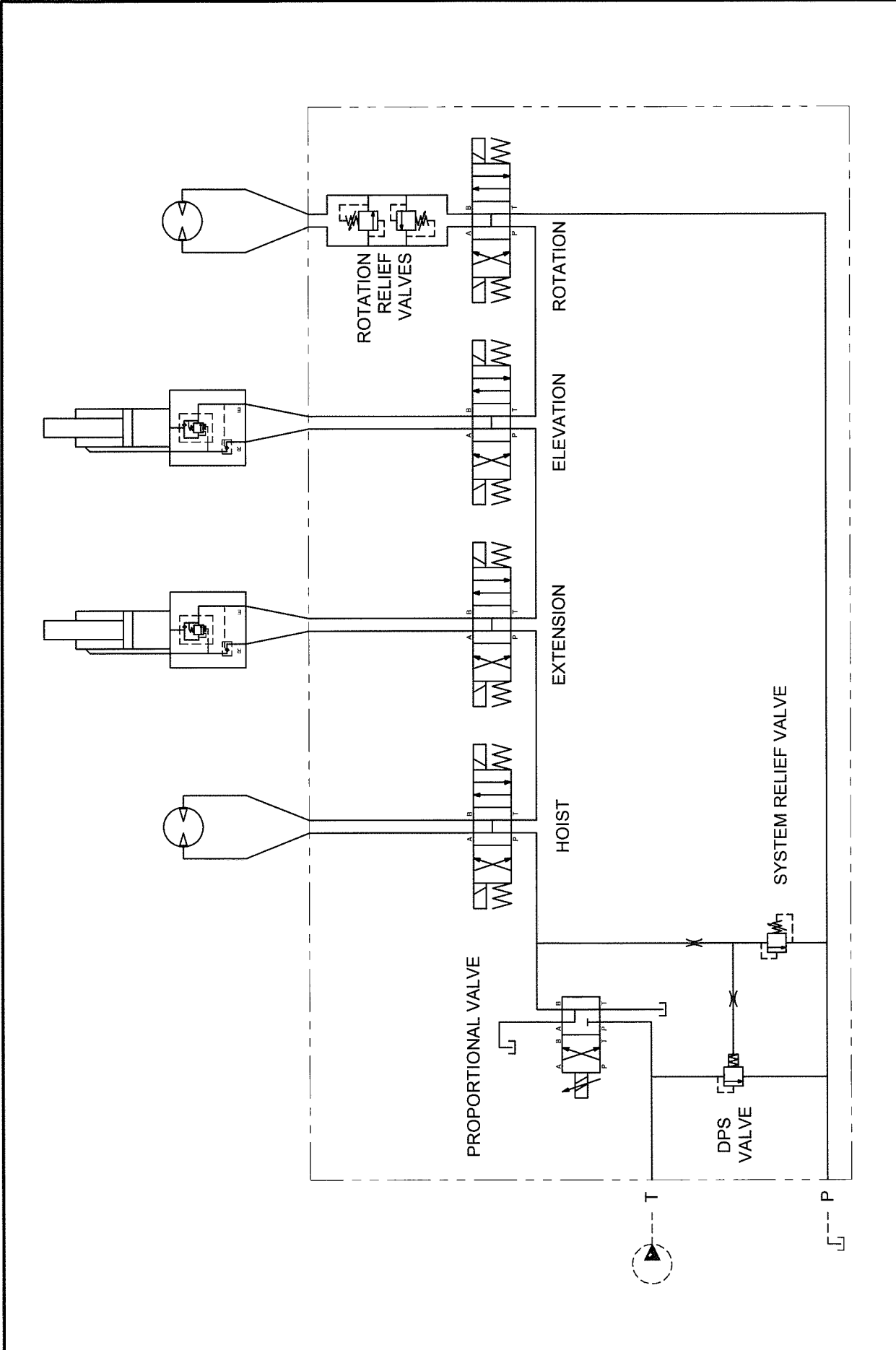

| | | | | |
|---|---|-------------------------------|--|-------------------------------|
|  | Houston TX (713)-688-5533 www.liftmoore.com | DRWN BY: JC DATE: 04/08/10 | SHCEM, HYD PROP LIMITED ROTATION MANIFOLD 23577 | DRAWING NO. 50770-0 |
|---|---|-------------------------------|--|-------------------------------|

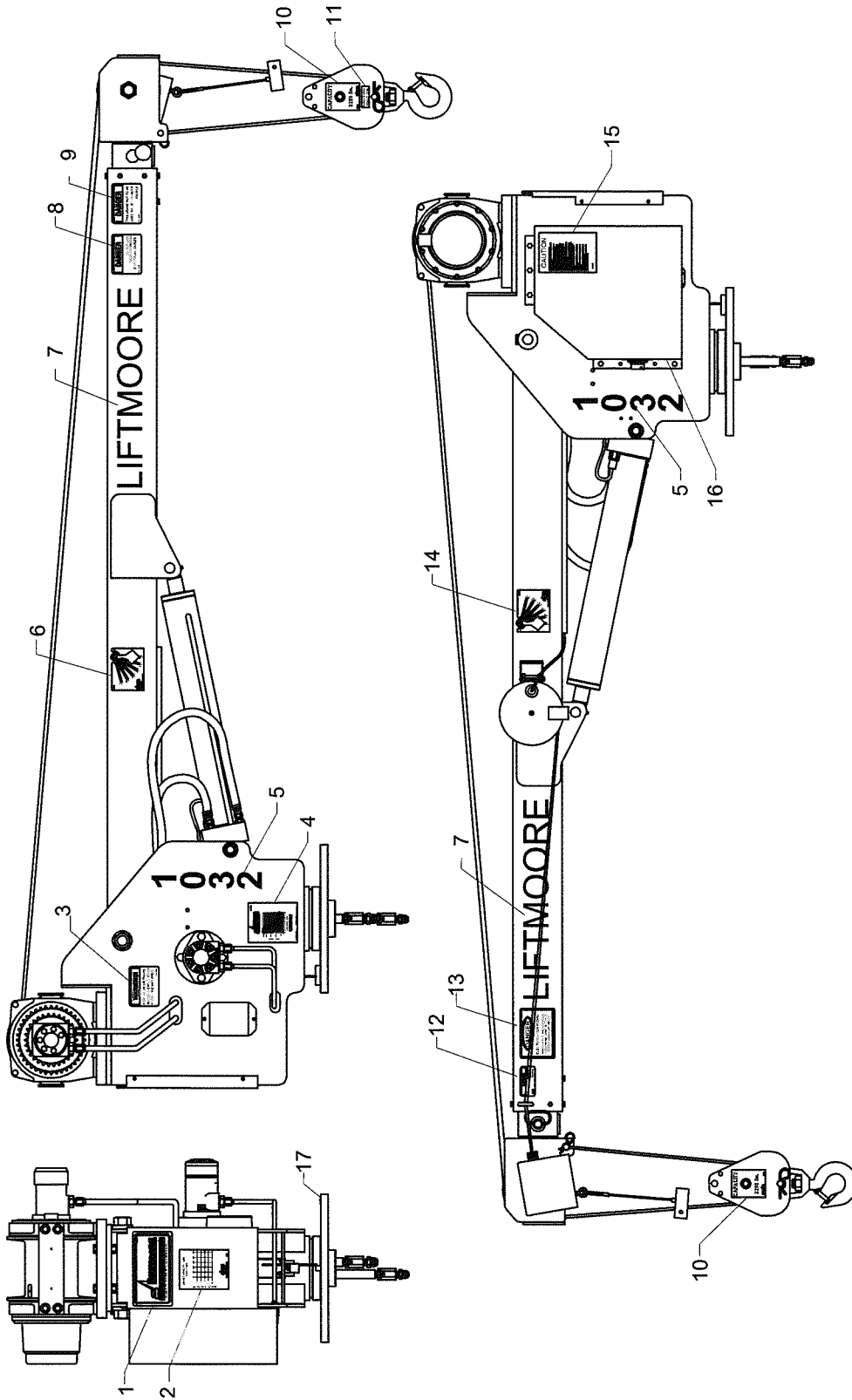

| # | PN | DESCRIPTION | QTY | # | PN | DESCRIPTION | QTY | # | PN | DESCRIPTION | QTY |
|---|-------|--------------------------------|-----|----|-------|--------------------------------|-----|----|-------|-------------------------------|-----|
| 1 | 15581 | DECAL, LOGO LARGE | 1 | 7 | 33165 | DECAL, LIFTMOORE - 2.50" | 2 | 13 | 15618 | DECAL, DANGER ELECTRIC INJURY | 1 |
| 2 | 22382 | DECAL, LOAD CAPACITY 10K-7-15 | 1 | 8 | 15579 | DECAL, DANGER CABLES | 1 | 14 | 22375 | DECAL, ANGLE PENDULUM LEFT | 1 |
| 3 | 15615 | DECAL, WARNING TRAVELING BLOCK | 1 | 9 | 32085 | DECAL, LIFTING PERSONNEL | 1 | 15 | 16102 | DECAL, CAUTION READ MANUAL | 1 |
| 4 | 33025 | PLATE, SERIAL 3200/1032 | 1 | 10 | 32819 | DECAL, TRAVEL BLOCK 3200 LBS. | 2 | 16 | 15577 | DECAL, ATTENTION BATTERY | 1 |
| 5 | 16534 | DECAL, 1032 | 2 | 11 | 22814 | DECAL, BLOCK & HOOK WT. 15 lbs | 1 | 17 | 23389 | PLATE, SERIAL NO. MACH | 1 |
| 6 | 22376 | DECAL, ANGLE PENDULUM RIGHT | 1 | 12 | 15612 | DECAL, CAUTION PIN MUST BE IN | 1 | | | | |

Houston TX
(713)-688-5533
www.liftmoore.com

LIFTMOORE

DRWN BY: JC
DATE: 01/20/10

DECAL DIAGRAM FOR THE
1032X & XP

DRAWING NO.
58372-0

THIS DRAWING INTENTIONALLY LEFT BLANK

FOR FUTURE ADDITIONS

OR

A PART OR FEATURE IS NOT APPLICABLE TO THIS CRANE



Houston TX
(713)-688-5533
www.liftmoore.com

DRWN BY:

DATE:

DRAWING NO.

LIFTMOORE LIMITED WARRANTY

Parts and Structural

Liftmoore, Inc. warrants each LIFTMOORE crane to be free from defects in materials and workmanship for twelve (12) months from the date of delivery to the original customer. Under the terms of this warranty the crane structural components manufactured by LIFTMOORE, Inc. are warranted for thirty-six (36) months from the date of delivery to the original customer. LIFTMOORE, Inc. will repair or replace, as its sole discretion, any equipment or part that is returned f.o.b. to LIFTMOORE, Inc.'s plant at 7810 Pinemont Drive, Houston, Texas 77040, or to one of its authorized dealers, and is found by LIFTMOORE, Inc. or its authorized dealer to have been defective at the time of original delivery.

The foregoing warranty is the exclusive warranty made by LIFTMOORE, Inc. with respect to its cranes and is in lieu of all other warranties. ANY AND ALL OTHER WARRANTIES, EXPRESS OR IMPLIED, INCLUDING ANY WARRANTY OF MERCHANTABILITY OR FITNESS OF ANY CRANE FOR A PARTICULAR PURPOSE OR OPERATION, ARE HERBY EXPRESSLY DISCLAIMED.

The foregoing warranty applies only to LIFTMOORE cranes under normal use and service and does not apply in the event of damage caused by repair or alteration or damage during shipment, accident, negligence, overloading, or misuse, including operator's failure to follow any of the instructions issued with the crane.

This warranty is limited to the original purchaser and is not assignable. In order to submit a claim, the original purchaser must provide a copy of the original invoice for the crane in question within twelve (12) months following the delivery date and within 30 days from the date of repair.

The warranty applies only when the LIFTMOORE crane is used for commercial purposes and does not cover any purchase for use for personal, family or household purposes.

LIMITATION OF LIABILITY: LIFTMOORE, Inc.'s liability for any losses or damages resulting from any cause whatsoever, including LIFTMOORE, Inc.'s NEGLIGENCE or from a defective crane irrespective of whether such defects are discoverable or latent, shall in no event exceed the purchase price of the crane to which losses or damages are claimed, or at the election of LIFTMOORE, Inc., the repair or replacement of the defective crane.

In no event shall LIFTMOORE, Inc. be liable for any special, incidental, or consequential damages, including commercial losses or costs of any kind sustained by purchaser or any other person or for any damages for which purchaser may be liable to other persons by reason of any defect in any LIFTMOORE crane or any part thereof.

LIFTMOORE, Inc. reserves the right to make changes in design or construction of its cranes at any time without obligating itself to make such changes on cranes previously manufactured.

No agent, employee, or representative of LIFTMOORE, Inc. has authority to amend or modify the foregoing warranty or to bind LIFTMOORE, Inc. by any other warranty, guaranty, or assumption of liability.

In the event any provision of this warranty is for any reason held ineffective, the remaining provisions shall remain in full force and effect.

Some states do not allow limitations on how long an implied warranty lasts or the exclusion or limitation of incidental or consequential damages, so the above limitations and exclusions may not apply to you. This warranty gives you specific legal rights, and you may also have other legal rights that vary from state to state.

