

# TABLE OF CONTENTS

USERS MANUAL 23909

2000

9 FT & 14 FT BOOMS

## SECTION I GENERAL OPERATION, INSPECTION, AND MAINTENANCE

CRANE SAFETY RULES .....	F1122-B .....	1-1
INTRODUCTION .....	F1111-D .....	1-3
OPERATING RESTRICTIONS .....	F1112-E .....	1-4
OPERATING PRACTICES .....	F1112-E .....	1-4
INSPECTION AND MAINTENANCE .....	F1113-C .....	1-7
MONTHLY INSPECTION REPORT .....	F1123-B .....	1-9
STANDARD HAND SIGNALS FOR CRANE OPERATIONS ..	F2409-0 .....	1-10

## SECTION II CRANE SYSTEMS AND TROUBLESHOOTING

PENDANT CONTROL .....	F1531-0 .....	2-1
SAFETY SYSTEM .....	F1531-0 .....	2-2
ELECTRIC HOIST .....	F1239-0 .....	2-3
MANUAL FUNCTIONS .....	F1247-0 .....	2-4
TROUBLESHOOTING ELECTRIC HOIST .....	F1243-A .....	2-5

## SECTION III CRANE SPECIFICATIONS

LIFTING CAPACITIES .....	F1245-C .....	3-1
POWER FUNCTIONS AND SPEEDS .....	F1245-C .....	3-2

## SECTION IV PARTS

BOX PARTS LIST .....	F1719-0 .....	4-1
CRANE ASSEMBLY .....	DWG.24188-A .....	4-2
PENDANT CONTROL .....	DWG.30122-C .....	4-3
TRAVEL BLOCK ASSEMBLY .....	DWG. N/A .....	4-4
BOOM-BODY ASSEMBLY .....	DWG.23906-0 .....	4-5
BODY ASSEMBLY .....	DWG.23905-0 .....	4-6
BASE-HOUSING ASSEMBLY .....	DWG.50736-B .....	4-7
BOOM ASSEMBLY – 9 FT .....	DWG.18942-A .....	4-8
BOOM ASSEMBLY – 14 FT .....	DWG.20293-A .....	4-9
WINCH DRAWING .....	DWG.23872-C .....	4-10
WINCH PARTS LIST .....	DWG.23872-C .....	4-11
ELECTRICAL SCHEMATIC .....	DWG.50386-B .....	4-12
DECAL DIAGRAM .....	DWG.58287-A .....	4-13

WARRANTY .....	F1442-A
----------------	---------



# TABLE OF CONTENTS

USERS MANUAL 23909

2000

9 FT & 14 FT BOOMS

THIS PAGE INTENTIONALLY LEFT BLANK



F1720-E  
4/25/16

HOUSTON, TEXAS  
FAX: (800) 824-5559 (USA & Canada)  
FAX: (713) 688-6324  
PHONE: (713) 688-5533  
[www.liftmoore.com](http://www.liftmoore.com)

## CRANE SAFETY RULES

### CAUTION!

1. READ AND UNDERSTAND OPERATOR'S MANUAL.
2. INSPECT VEHICLE AND CRANE, INCLUDING ITS OPERATION, BEFORE DAILY USE.
3. USE THIS EQUIPMENT ONLY ON SOLID LEVEL GROUND WITH OUTRIGGERS OR JACKSTANDS PROPERLY SET.
4. BEFORE OPERATING THE CRANE REFER TO MAXIMUM LOAD CHART ON CRANE FOR OPERATING LOAD LIMITS.
5. BE SURE LOAD BEING LIFTED IS WITHIN SAFE WINCH CAPACITY AS WELL AS SAFE CRANE CAPACITY. MULTI-PART LINE OPERATION IS REQUIRED WHEN SINGLE LINE LOAD CAPACITY OF WINCH IS EXCEEDED.
6. DO NOT OPERATE, WALK, OR STAND UNDER THE BOOM OR ANY SUSPENDED LOAD.
7. ALWAYS PAY OUT LOAD LINE BEFORE EXTENDING BOOM. WIRE ROPE DAMAGE AND / OR BREAKAGE MAY OCCUR.
8. BOOM MUST BE IN ITS REST BEFORE MOVING VEHICLE.
9. BOOM TIP MUST BE DIRECTLY OVER THE LOAD BEFORE ANY LIFTING IS STARTED. DO NOT DRAG LOADS WITH THIS CRANE.
10. MAINTAIN THIS CRANE AS REQUIRED IN THE OWNER'S MANUAL.
11. DO NOT ALLOW PERSONNEL TO RIDE ON THE LOAD LINE, LOAD, OR BOOM OF THIS CRANE.
12. IT IS UNLAWFUL TO OPERATE THIS EQUIPMENT WITHIN TEN FEET OF HIGH VOLTAGE LINE



THIS PAGE INTENTIONALLY LEFT BLANK



F1122-B  
05/12/08

HOUSTON, TEXAS  
FAX: (800) 824-5559 (USA & Canada)  
FAX: (713) 688-6324  
PHONE: (713) 688-5533  
[www.liftmoore.com](http://www.liftmoore.com)

## INTRODUCTION

This crane is a powerful machine designed to lift and move heavy loads. There are many hazards associated with these operations. Liftmoore has designed this crane to be as safe as possible but -

**IT IS THE OPERATOR'S RESPONSIBILITY TO PREVENT ACCIDENTS!**

This takes pre-planning, attention, and knowledge of basic principles and rules. Even if you have used similar cranes, reading this manual in its entirety will help prevent damage, injury, or even loss of life; benefits well worth the short amount of time it takes to read these pages.

### REGULATORY AUTHORITY

Use of this crane is governed by OSHA 29 CFR 1910.180 and may be governed by other federal, state, or local regulations.

**IT IS THE OPERATOR'S RESPONSIBILITY TO UNDERSTAND AND COMPLY WITH ALL APPLICABLE REGULATIONS GOVERNING THE OPERATION, INSPECTION, AND MAINTENANCE OF THIS CRANE.**

Personnel should be trained, tested, and certified, as recommended by OSHA and ANSI standards, before operating this crane.

### USING THIS MANUAL

This manual assumes that the crane is mounted on a typical service body type or similar truck, which is powered by the vehicle electrical or hydraulic system, and is controlled by either the standard pendant control or FM radio control sold by Liftmoore, Inc.

This manual is supplied to provide basic guidelines for the safe use, routine maintenance, and general inspections of this crane.

Laws, regulations, standards, or policies may be more restrictive than this manual. If a conflict exists for any limit or condition, the safest or most prohibitive shall be used. Under no circumstances shall the load, moment, or stability ratings be exceeded.

Pay particular attention to the following:

**WARNING!** – Draws attention to hazards, conditions, or procedures that if not observed could result in injury or death.

**CAUTION!** – Draws attention to hazards, conditions, or procedures that if not observed could result in damage to the crane, load, or other equipment. Equipment failure could in turn lead to injury or death.

**NOTE!** – Draws attention to conditions or procedures that are essential to emphasize.

For questions, interpretations, or to report errors, please contact Liftmoore, Inc, Engineering Dept.



## OPERATING PRACTICES

### OPERATING RESTRICTIONS

#### DUTY CYCLE

For Electric Cranes the duty cycle time should be limited to 10%. This is limited by heat buildup in the motors and declining charge in the batteries. (Installing extra batteries near the crane helps keep the voltage at maximum.)

#### PERSONNEL

LIFTING OR MOVING OF PERSONNEL IS STRICTLY PROHIBITED! This crane was neither designed nor intended to lift personnel. Under no circumstances should anyone be allowed to ride on the crane, line, or load. All non-essential personnel must be kept away when using the crane. The load must never be moved over people, nor must anyone be allowed to pass or stand under a suspended load.

#### ELECTRICAL LINES

Consult ANSI B30.5 for operating procedures, minimum safe distances, and prohibited zones when working around electrical lines or poles.

When operating near electrical power lines, the crane must be positioned so that the distance from the crane to the lines or poles is equal to or greater than the length of the fully extended boom plus the minimum safe distance required.

All parts of the crane, line, and load must be kept a minimum safe distance from electrical power lines and poles. This distance is 10 feet for electrical lines carrying 50kV or less.

**UNDER NO CIRCUMSTANCES SHOULD A CRANE BE OPERATED UNDER ELECTRICAL POWER LINES.**

#### SETUP

**POSITION** The vehicle must be positioned so that the load is kept as close to the crane base as possible to reduce the moment on the crane. Consideration must be given to starting and ending position as well as firmness and slope of the ground and any obstructions.

**OUTRIGGERS** The outriggers or jackstands must be firmly set and the vehicle as level as possible. This will reduce the stresses on the rotation drive and keep the load off the vehicle's suspension. Keep in mind that the weight on the vehicle will shift as the crane and load is rotated.

**MANUAL BOOM EXTENSION** If the manual extension part of the boom is needed, it must be extended and the boom pin placed in the required position. Insert the pin and replace the pin's hairpin keeper before attempting to lift any load.

**LOAD LIMIT** The operator must understand the crane load chart. The operator must ensure that the load is within the load limits over the entire range which it will be moved. Be sure to include the weight of any lifting devices including the travel block.

The load limit chart is attached to the side of the crane to aid the operator.

The boom angle indicator and chart aids the operator in determining the load capacity at various boom angles and extensions. It also gives the load limit at that configuration.

**STABILITY** A stability chart must be posted near the crane. The operator must understand the stability chart. The crane may be de-rated over some areas of its operating radius.



**TRAVEL BLOCK** The operator must determine if the load is within the single line compatibility of the winch or if a multi-part line configuration is needed.

**REEVING** Ensure the proper routing of the rope through the sheaves and travel block. The rope must lie in the sheave groove and must not rub against any metal objects.

Ensure the rope is correctly wound on the winch drum. The crane assembly drawing will indicate if the rope must be wound over the top or bottom of the drum. The rope must never contact any part of the winch mounting.

### WARNING!

If the winch winding direction is reversed the brake will not work and the load will fall.

### ATTACHING THE LOAD

**POSITION** The boom tip must be moved over the load before lifting so that it will be lifted straight up.

### CAUTION!

Never drag a load with the crane. Dragging a load puts very high stresses on the crane for which it was not designed.

**ROPE** Check the rope condition to ensure it is not frayed or damaged. Ensure that the rope is not kinked and that it does not contact any sharp edges or make any sharp bends.

If using double line configuration, ensure that the lines are not twisted.

### CAUTION!

Never wrap the hoist rope around the load! Serious damage to the rope WILL occur.

**HOOK** Always make sure the load is applied to the throat of the hook. Never use a bent hook.

### CAUTION!

Always lift with the throat of the hook. Never lift with the load applied to the tip of the hook. Doing so will bend the hook.

**SLINGS** If the load does not have a lifting eye, use a nylon, chain, or other type of sling designed for lifting and rated for loads greater than that being lifted.

**BALANCE** Ensure the load will be secure and balanced when lifted. Ensure that the load cannot shift in the sling and that the sling cannot slide across the hook should the load become unbalanced.

### LIFTING THE LOAD

Before lifting, ensure that the load is free from all mountings and is no way attached or stuck to anything.

Ensure that at least five full wraps remain on the winch drum at all times.

Test the winch brake by lifting the load a few inches and ensuring that it does not slip.



### **HOLDING THE LOAD**

The operator must keep the load in sight at all times once it is lifted.

The operator must never leave the controls once the load is lifted.

The operator must ensure that no one is allowed to pass or stand under a suspended load.

### **CAUTION!**

Never move the vehicle with a suspended load. Doing so will put dynamic loads on the crane for which it was not designed.

### **MOVING THE LOAD**

Before moving the load, make sure the path is free of any obstructions or people.

Avoid sudden accelerations or stops. Speeds must be kept to a minimum, especially rotation, to keep the load from swinging.

Avoid sudden reversing of direction. Do not reverse direction while the load is still moving.

Make sure that no part of the crane, boom, or load makes contact with any obstruction or comes within a minimum of ten feet from any electrical line.

### **TRANSIT**

While in transit, the crane must be stowed, preferably in a boom rest. The crane must be prevented from rotating and the hook prevented from swinging.





## INSPECTION AND MAINTENANCE

OSHA and ANSI require frequent and periodic inspections. Records of these inspections must be kept readily available. Liftmoore requires periodic maintenance to ensure proper operation and prolonged life of the crane.

### INSPECTION

#### DAILY INSPECTION

OSHA 29CFR 1910.180 (d)(2)(i) requires the following be checked daily prior to use:

- All control mechanisms for maladjustment interfering with proper operation as well as for excessive wear of components and contamination by lubricants or other foreign matter.
- All safety devices for malfunction. This should include the anti-two block and pressure switch.
- Deterioration or leakage in air or hydraulic systems.
- Crane hooks with deformations or cracks. For hooks with cracks or having more than 15 percent in excess of normal throat opening or more than 10 deg. twist from the plane of the unbent hook.
- Electrical apparatus for malfunctioning, signs of excessive deterioration, dirt, and moisture accumulation. This should include the battery terminals, master disconnect switch, electrical swivel
- The wire rope shall be replaced if any of the following conditions are noted:
  - Kinking, crushing, bird-caging, or other damage
  - Reductions from nominal diameter of more than one-sixty-fourth inch for diameters up to and including five-sixteenths inch, one-thirty-second inch for diameters three-eighths inch to and including one-half inch.
  - Thimble is not in place or is damaged
  - Any evidence of heat damage
  - Six or more randomly distributed broken wires in 1 lay
  - Three or more broken wires in 1 strand in 1 lay

#### MONTHLY INSPECTION

A thorough inspection of all ropes in use shall be made at least once a month and a certification record which includes the date of inspection, the signature of the person who performed the inspection and an identifier for the ropes shall be prepared and kept on file where readily available. All inspections shall be performed by an appointed or authorized person. Any deterioration, resulting in appreciable loss of original strength shall be carefully observed and determination made as to whether further use of the rope would constitute a safety hazard. Some of the conditions that could result in an appreciable loss of strength are the following:

- Reduction of rope diameter below nominal diameter due to loss of core support, internal or external corrosion, or wear of outside wires.
- A number of broken outside wires and the degree of distribution of concentration of such broken wires.
- Worn outside wires.



- Corroded or broken wires at end connections.
- Corroded, cracked, bent, worn, or improperly applied end connections.
- Severe kinking, crushing, cutting, or unstranding.

#### PERIODIC INSPECTION

An Annual Inspection Form is included in this manual. OSHA 29CFR 1910.180 (d)(2)ii) requires periodic inspections of this crane. Liftmoore recommends an annual inspection using the included form.

#### MAINTENANCE PRECAUTIONS

Before any maintenance is performed, the vehicle should be out of the way and the crane secured.

#### WARNING!

Never perform any maintenance while the crane has any type of load on it. Use the manual operation procedure to lower the load if necessary.

#### WARNING!

Hydraulic cylinders may have high pressure stored in them even after hydraulic power is removed.

The counterbalance and pilot operated check valve in the cylinder will always hold some pressure in the cylinder. Slightly extending the cylinder then retracting a small amount will relieve most of the pressure in the cylinder. **DO NOT DEADHEAD THE CYLINDER!** This will store the maximum amount of pressure in the cylinder. Care should be taken when either valve is removed from the cylinder as some pressure will still remain.

After any maintenance has been performed the crane shall not be operated until all guards have been reinstalled, all safety devices reactivated, and maintenance equipment removed.

**LUBRICATION** Refer to the crane specification section for the periodic maintenance schedule and type of lubrication required.

**BOLTS** Bolts may loosen over time due to vibration; therefore they should be checked periodically. If bolts need to be replaced, make sure they are replaced with bolts of equal or greater strength. Check the periodic maintenance schedule (Crane Specification Section) for bolt specification and torque.

#### NOTE!

Sheave and boom and cylinder pivot bolts are not standard bolts. The shank and thread length of these bolts have been modified so that they do not pivot on the threads. Consult the parts section of this manual for part numbers of these bolts.

#### OTHER MAINTENANCE

Refer to parts drawings for any specific maintenance or adjustment procedures such as hydraulic winch brake, rotation drive gear set adjustment, ect.



## MONTHLY INSPECTION REPORT

Crane Model No. \_\_\_\_\_ Serial Number \_\_\_\_\_

Are Boom Hitch Pins and Keepers in place?	Yes _____	No _____
Wire Line Hook with Safety Latch Working?	Yes _____	No _____
Is Hook OK, (Not bent)?	Yes _____	No _____
Is Thimble on Wire Rope OK?	Yes _____	No _____
Is Traveling Block in use?	Yes _____	No _____
Is Wire Rope OK, not kinked or frayed?	Yes _____	No _____
Are all Boom Sections straight?	Yes _____	No _____
Are Sheave Bolts in place and tight?	Yes _____	No _____
Do all Sheaves rotate easily?	Yes _____	No _____
Are Mounting Bolts tight?	Yes _____	No _____
Is Anti Two-Block functioning properly?	Yes _____	No _____
Is Boom Angle Indicator in place and functioning and is Chart legible?	Yes _____	No _____
Are Cylinder Mounting Bolts secure?	Yes _____	No _____
Are Winch Mounting Bolts tight?	Yes _____	No _____
When stopped does winch drift less than 1.0 Inches?	Yes _____	No _____
Is Load Chart in place and easily read?	Yes _____	No _____
Are functions on Pendant operating correctly?	Yes _____	No _____
Is Hydraulic Reservoir full?	Yes _____	No _____
Is Outrigger straight and functioning?	Yes _____	No _____





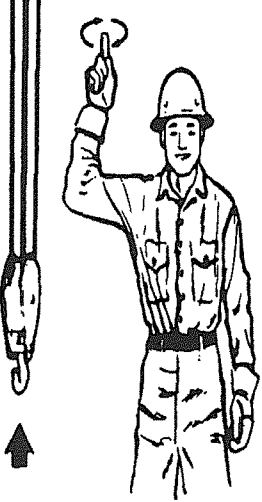
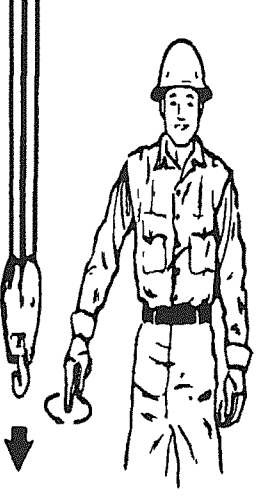
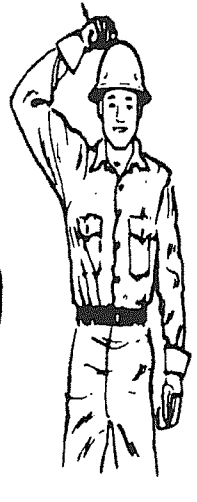
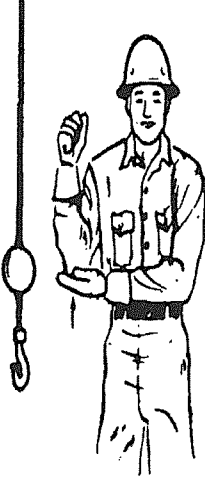
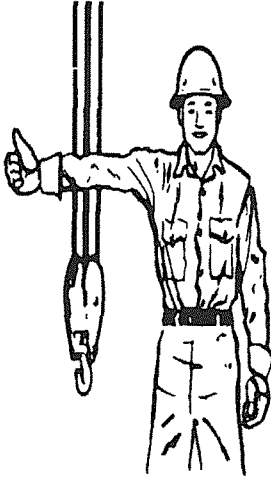
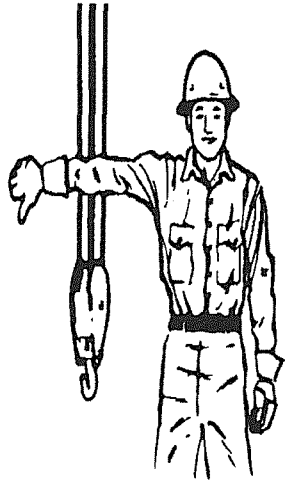

Any items checked 'No' must be repaired before using this crane.

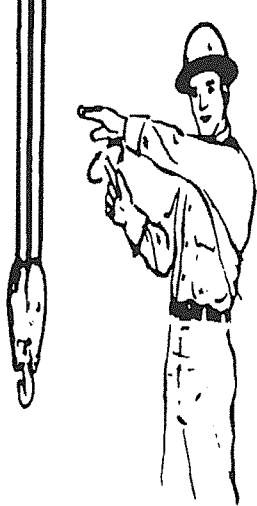
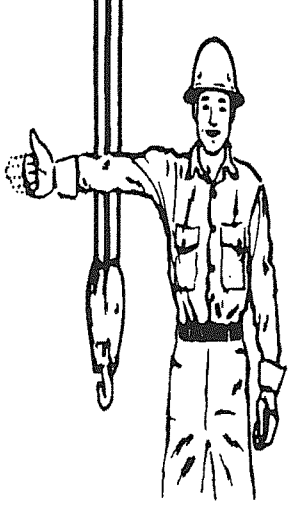
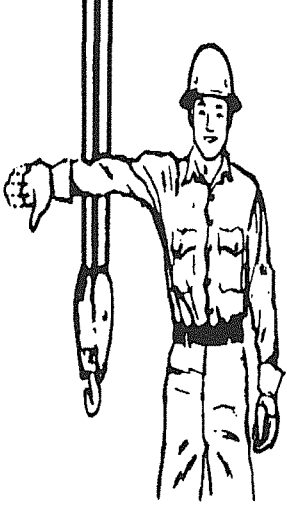
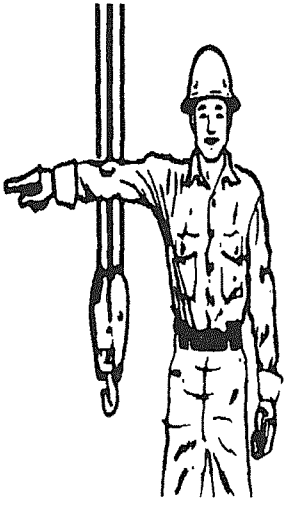
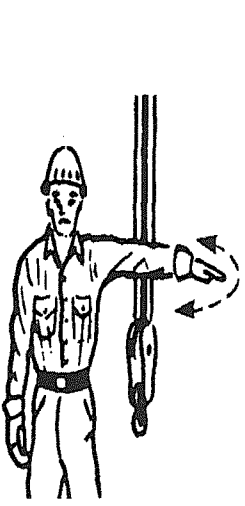
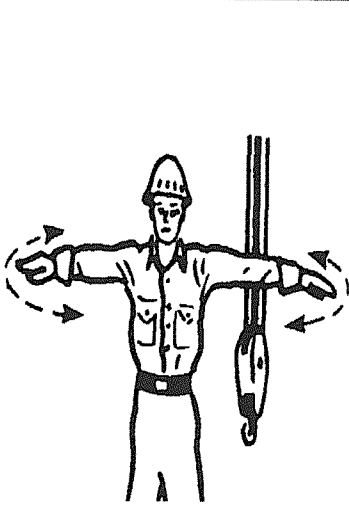

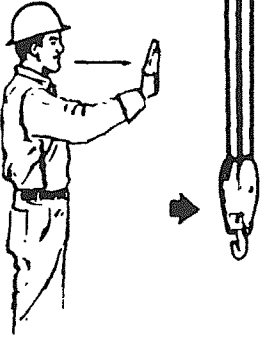
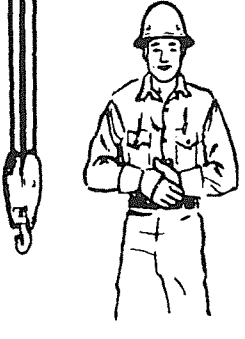
**STANDARD HAND SIGNALS FOR CONTROLLING CRANE OPERATIONS**

 <p><b>HOIST.</b> With forearm vertical, forefinger pointing up, move hand in small horizontal circle.</p>	 <p><b>LOWER.</b> With arm extended downward, forefinger pointing down, move hand in small horizontal circle.</p>	 <p><b>USE MAIN HOIST.</b> Tap fist on head; then use regular signals.</p>
 <p><b>USE WHIPLINE (Auxiliary Hoist).</b> Tap elbow with one hand; then use regular signals.</p>	 <p><b>RAISE BOOM.</b> Arm extended, fingers closed, thumb pointing upward.</p>	 <p><b>LOWER BOOM.</b> Arm extended, fingers closed, thumb pointing downward.</p>

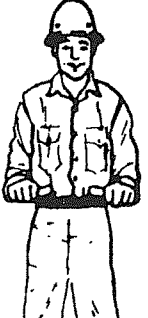
 <p><b>MOVE SLOWLY.</b> Use one hand to give any motion signal and place other hand motionless in front of hand giving the motion signal. (Hoist slowly shown as example.)</p>	 <p><b>RAISE THE BOOM AND LOWER THE LOAD.</b> With arm extended, thumb pointing up, flex fingers in and out as long as load movement is desired.</p>	 <p><b>LOWER THE BOOM AND RAISE THE LOAD.</b> With arm extended, thumb pointing down, flex fingers in and out as long as load movement is desired.</p>
 <p><b>SWING.</b> Arm extended, point with finger in direction of swing of boom.</p>	 <p><b>STOP.</b> Arm extended, palm down, move arm back and forth horizontally.</p>	 <p><b>EMERGENCY STOP.</b> Both arms extended, palms down, move arms back and forth horizontally.</p>

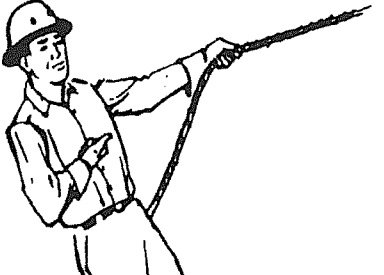
 <p><b>TRAVEL.</b> Arm extended forward, hand open and slightly raised, make pushing motion in direction of travel.</p>	 <p><b>DOG EVERYTHING.</b> Clasp hands in front of body.</p>	 <p><b>TRAVEL (Both Tracks).</b> Use both fists in front of body, making a circular motion about each other, indicating direction of travel, forward or backward. (For land cranes only.)</p>
 <p><b>TRAVEL. (One Track)</b> Lock the track on side indicated by raised fist. Travel opposite track in direction indicated by circular motion of other fist, rotated vertically in front of body. (For land cranes only.)</p>	 <p><b>EXTEND BOOM (Telescoping Booms).</b> Both fists in front of body with thumbs pointing outward.</p>	 <p><b>RETRACT BOOM (Telescoping Booms).</b> Both fists in front of body with thumbs pointing toward each other.</p>
 <p><b>EXTEND BOOM (Telescoping Boom).</b> One Hand Signal. One fist in front of chest with thumb tapping chest.</p>		 <p><b>RETRACT BOOM (Telescoping Boom).</b> One Hand Signal. One fist in front of chest, thumb pointing outward and heel of fist tapping chest.</p>

## CRANE OPERATION

1 or 2 Powered Functions

### PENDANT CONTROL

All user inputs are facilitated by the remote pendant control. The pendant control plug mates with the crane control socket and controls the hoist and other functions, if applicable, through contactors or solenoids located on the crane.

### OPERATION

Raise the cover on the crane control socket and plug in the pendant. Ensure all pins are straight and free of dirt, moisture, and corrosion.

#### NOTE!

The control socket cover locks the plug in the socket and must be lifted to unplug the pendant.

### CARE AND MAINTENANCE

The pendant control is designed to be as rugged and maintenance free as possible; however, care should be used in handling and storage as it is expensive to replace.

Follow these simple practices:

- Keep the pendant out of the weather
- When not in use, store the pendant inside the vehicle
- Do not wrap the wire too tightly as internal damage to the wires may result
- Do not place sharp or heavy objects on the cord

#### NOTE!

The pendant is designed to be weatherproof not waterproof. It may be used in inclement weather, but if left outside or where water can puddle, water can seep inside.

Maintenance should be limited to routine inspection of the plug, wire, and fasteners.

## SAFETY SYSTEM

This crane does not have a load limiting or ATB safety system.

It is the operator's responsibility to understand and strictly adhere to the load limits of the crane. The operator must also know the weight of any objects to be lifted.

The operator must always be aware of the hook and travel block position and ensure that the crane is never two-blocked (allowing the travel block or hook to contact the crown plate.)

## ELECTRICAL SYSTEM

This crane is powered by the vehicle electric system. Electrical power is connected at the crane by a single pole Mecon brand or similar type electrical connector. On L Series, 206M, and 2000A model cranes the connector is attached to the crane housing.

On 206R cranes the connection is made at the base and is transferred to the housing through an electrical swivel. The swivel allows for continuous, unlimited rotation of the crane.

#### NOTE!

The vehicle battery **MUST** be rated at 90 Amp/Hour minimum. It is highly recommended that a second battery, wired in parallel with the vehicle battery, be placed as close to the crane as possible. Deep cycle batteries should be used.

### CIRCUIT BREAKER

A circuit breaker is supplied with the crane and should be installed as close to the battery as possible.

### DISCONNECT SWITCH

A power disconnect switch is supplied with the crane. Disconnecting the power will prevent inadvertent or unauthorized use and help prevent corrosion at electrical connections.



### **LOAD SENSOR (OPT.)**

The optional load sensor acts to stop the hoist lifting function when the crane is overloaded. The sensor is a switch located under the flange plate at the front of the crane's housing. When an overload is detected, the switch will open. Winch up will not function under this condition. The switch will reset after the load is removed. This can be done by setting the load down with the winch.

#### **CAUTION!**

The load sensor will not function when the elevation cylinder is fully retracted and is inaccurate when the boom is below horizontal.

#### **CAUTION!**

The operator must never rely strictly on the load sensor to determine overload conditions. The load and load limits must always be known and adhered to.





## ELECTRIC HOIST

Permanent Magnet Motor

This Liftmoore crane features an electrically driven planetary gear hoist. The hoist is powered in both directions and features an automatic internal brake to positively control the load.

The hoist is permanently lubricated at the factory. Barring damage or part replacement, no further lubrication is necessary.

### MOTOR

The hoist motor is a permanent magnet, reversible, direct current (DC) motor.

### CAUTION!

The hoist motor is rated for intermittent duty. Duty cycle is limited to 5 minutes in 30 to allow the motor to cool. Extended use can damage the motor.

### CAUTION!

When the motor approaches stall, a very rapid heat build up occurs which can cause permanent motor damage. Discontinue use when the motor speed is reduced excessively by voltage drop or load.

### BRAKE

The hoist features a single acting, overrunning brake. It automatically activates to hold the load and assist in lowering the load.

### WARNING!

The hoist brake only functions in one direction. If the hoisting direction is reversed by reversing the rope winding direction the brake will not hold and the load will fall. Serious injury or death could occur.

The brake is factory set and is not adjustable. If the brake fails to hold the load or if downward drift becomes excessive the brake must be replaced.

### DIRECTIONAL CONTROL

Motor direction is controlled by either a solenoid pack or sealed contactor. Schematically, they are identical - two double pole-double throw solenoids are used to reverse polarity to the motor terminals.

Signal voltage, controlled by the pendant, energizes the selected directional solenoid, directing power to the winch terminal through the normally open terminal. The other terminal remains grounded through the normally closed terminal of the other solenoid.

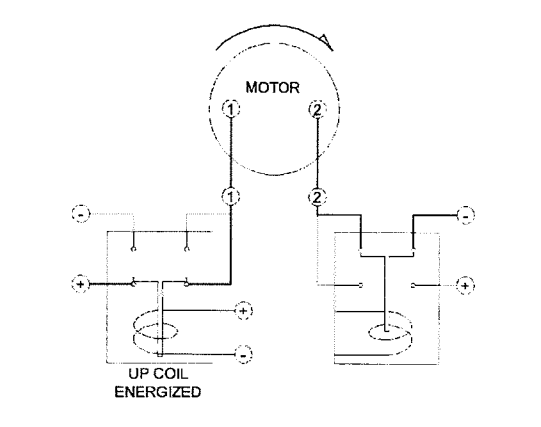
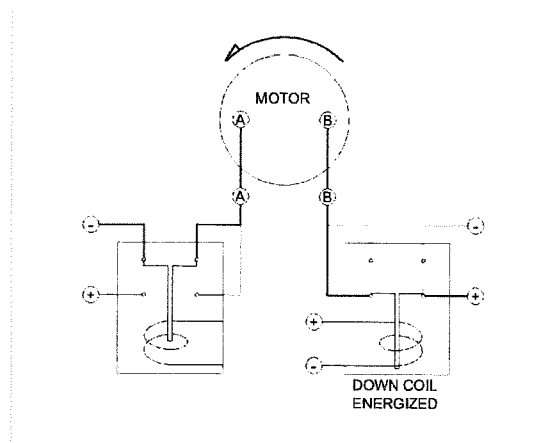

## MANUAL FUNCTIONS

Elevation, Extension, Rotation

### ELEVATION

On all cranes except the L-15, the boom angle may be manually adjusted. The boom must be adjusted before lifting the load. Typical range is 0 to 75.

#### **WARNING!**

Do not stand under the boom when adjusting the boom angle. If the boom falls serious injury or death may result.

#### **WARNING!**

The boom and support bar can form a pinch point. When adjusting the boom angle be aware of the moving parts or hand injury may result.

#### **CAUTION!**

All boom support pins must be in place before lifting the load. If proper boom pins are not installed the boom may collapse under load causing serious damage and possible injury or death.

### EXTENSION

The boom may be manually extended as needed. The boom must be set to the desired length before lifting the load. A boom stop is provided to prevent the inner boom from being inadvertently removed from the outer boom.

#### **CAUTION!**

All boom pins must be in place before lifting the load. The boom stop will not support a load. If proper boom pins are not installed the boom may collapse under load causing serious damage and possible injury or death.

### ROTATION

The crane must be rotated manually. Taper roller bearings are utilized to reduce the force required.

#### **CAUTION!**

The force required to rotate the crane will increase dramatically if the truck is not level or if the load causes the truck to lean. Outriggers or jackstands **MUST** be used.

#### **CAUTION!**

Extreme caution must be used when rotating heavy loads. Even with the use of outriggers or jackstands the truck may tilt as the crane is rotated. Even a small lean may cause the load to become uncontrollable.

### BRAKE

The crane is equipped with a hand tightened band brake to help control the load when rotating.

#### **CAUTION!**

Even with the brake tightened the load may become uncontrollable if the vehicle becomes unlevel.

#### **CAUTION!**

The brake is not designed nor intended to hold the crane during transit. The crane must be held by a boom rest and/or feathered to the truck when not in use.



## TROUBLESHOOTING ELECTRIC HOIST

Permanent Magnet, Contactor Controlled

### IMPORTANT NOTE!

The importance of first physically checking every connection between the battery and the crane cannot be overstressed!

Poor connections or poor grounding account for a large percentage of hoist problems. Time is often wasted chasing other probable causes only to eventually find a loose or corroded connection. **Measuring the voltage is not sufficient.** Often a poor connection will allow enough amperage to operate a meter or test light, but not enough to operate the hoist, which requires very high amperage.

If the problem is random and intermittent then it is almost assuredly a loose or bad connection.

Another common problem is low battery voltage. Even if the battery is good when troubleshooting begins, running the winch can quickly drain a battery. If it can be done safely, it is best to have the vehicle running.

Also check the control socket and plug for bent, corroded, or dirty pins.

### CAUTION!

As the motor approaches stall, due to low voltage or excessive load, a very rapid heat build up occurs which will quickly damage the motor. If the motor is not turning, do not operate the switch for more than a second. Allow the motor to cool between attempts to make it run.

## HOIST OPERATES IN ONLY ONE DIRECTION

If the hoist only operates in one direction swap the control wires on the contactor. Activating the pendant switch in the working direction should now operate the hoist in the previous non-working direction.

**Example:** if hoist up is not working, after swapping the control wires activating the hoist down switch should cause the hoist to go up.

If it does then the hoist and contactor are working correctly and the problem is in the pendant crane socket or wiring. If it does not then the problem is the contactor or brake.

If the motor tries to turn but stalls then the problem is most likely the brake. Also, if the contactor makes a clicking noise then that is a good indication that it is working and, again, the problem is most likely the brake.

If the control wires were swapped in the previous step, return them to their original positions. Swap the motor wires (labeled 1 and 2). It is usually easiest to swap them at the motor.

Activating the pendant switch in the working direction should now operate the hoist in the previous non-working direction.

**Example:** if hoist up is not working, after swapping the motor wires activating the hoist down switch should cause the hoist to go up.

If it does, then one side of the contactor is not working and it needs to be replaced.

If it does not work, the problem is a brake malfunction. Inspect the brake installation. Correct any problems found. The brake cannot be repaired. Replace if any damage is found.



## HOIST DOES NOT RUN IN EITHER DIRECTION

If the hoist does not run in either direction then the problem is either lack of power to the control socket or pendant, lack of sufficient power to the motor, or hoist brake malfunction or motor failure.

If the contactor clicks when the switch is activated then the control socket is getting power.

If all connections have not been checked, do so now. Also ensure that the battery still has sufficient power. As a rule of thumb, if it has enough power to start the engine, then it is good.

Activate the winch toggle switch and check for voltage at motor contacts. If positive voltage is measured at both terminals, the problem may be the ground wire from the contactor. Check for tightness or corrosion on this wire.

Once sufficient power is ensured, if there is any indication that the motor is trying to turn but stalls the problem is the brake – have it replaced.

If there is no indication that the motor is trying to turn and the contactor has been tested, then replace the motor.

## TESTING THE PENDANT AND CONTROL WIRING

If the problem is narrowed to the control wiring, it is most likely caused by a cut or disconnected wire. A visual inspection of the wiring should be made and repairs made as necessary.

Refer to the schematic and pendant drawing for pin functions and locations.

If no visual defects are found and if a continuity tester is available, disconnect the pendant and check for continuity between the control socket pin and terminal at the contactor.

Alternately, a piece of wire or metal object may be used to short between the control socket power pin and the socket hoist pin(s). If the hoist operates then the problem is in the pendant.

If not, check for power at the control socket power pin. If there is no power, trace the wiring back, checking each connection until the problem is found. Correct as necessary.



## SECTION 3 CRANE SPECIFICATIONS

### MODEL 2000A CRANES

MOMENT RATING                      6 000 FT-LBS

MAX SINGLE LINE LOAD            2 000 LBS

#### LIFTING CAPACITIES AT VARIOUS LOAD RADII:

LOAD RADIUS (FT)	CAPACITY (LBS)
3	2,000
4	1,500
5	1,200
7	857
9	667
*11	545
*13	462
*14	429

\*OPTIONAL BOOM LENGTH

#### WINCH

LOAD (LBS)	LINE SPEED (FT/MIN)	AMP DRAW
0	14	23
1,000	12	47
2,000	10	102

#### DUTY CYCLE: 5 MINUTES IN 30

The winch is factory lubricated and should not require further lubrication in its lifetime. The winch brake cannot be adjusted. If brake drift is more than 1 inch under full load then it must be replaced.



F1245-C  
12/30/09

HOUSTON, TEXAS  
FAX: (800) 824-5559 (USA & Canada)  
FAX: (713) 688-6324  
PHONE: (713) 688-5533  
[www.liftmoore.com](http://www.liftmoore.com)

**ELECTRICAL**

VOLTAGE ..... 12 VDC  
FUSE-CONTROL WIRE ..... 15 AMP  
CRANE POWER CIRCUIT BREAKER ..150 AMP

**MOUNTING BOLTS**

½-13 GRADE 8                      EVERY 4 MONTHS  
TORQUE 110 FT-LBS DRY



F1245-C  
12/30/09

HOUSTON, TEXAS  
FAX: (800) 824-5559 (USA & Canada)  
FAX: (713) 688-6324  
PHONE: (713) 688-5533  
[www.liftmoore.com](http://www.liftmoore.com)

## LIST FOR BOX, CRANE PARTS 2000

Items with \* have detailed DWG's.

P/N 23908 - BOX, CRANE PARTS 2000  
23872 WINCH

- 1) P/N 23909 - MANUAL, CRANE 2000.....1pc
- 2) P/N 31022 - WIRE, 25' #4 AWG BATTERY .....1pc
- 3) P/N 30728 - WIRE, GROUND #4 X 3' LONG .....1pc
- 4) P/N 30760 - PIN, HITCH 0.75 X 4.50 W/H-PIN.....2pcs
- 5) P/N 30815 - SCREW, HHC 0.50-13 X 2.50 GR8.....4pcs
- 6) P/N 30474 - WASHER, LOCK 0.50 GR5 PLATED.....4pcs
- 7) P/N 31957 - NUT, HEX 0.50-13 GR8 PLATED.....4pcs
- 8) P/N 16878 - BREAKER, CIRCUIT 150 AMP.....1pc
- 9) P/N 16922 - TERMINAL, LUG #4 GA 0.25 DIA.....2pcs
- 10) \*P/N 30122 - CONTROL, PENDANT 206M/2000 4P.....1pc
- 11) P/N 22425 - INSTALLATION INTS. 2700 & 3200.....1pc
- 12) P/N 25794 - DECAL, LOAD CAPACITY 6,000.....1pc



F1719-A  
05/11/15

HOUSTON, TEXAS  
FAX: (800) 824-5559 (USA & Canada)  
FAX: (713) 688-6324  
PHONE: (713) 688-5533  
[www.liftmoore.com](http://www.liftmoore.com)

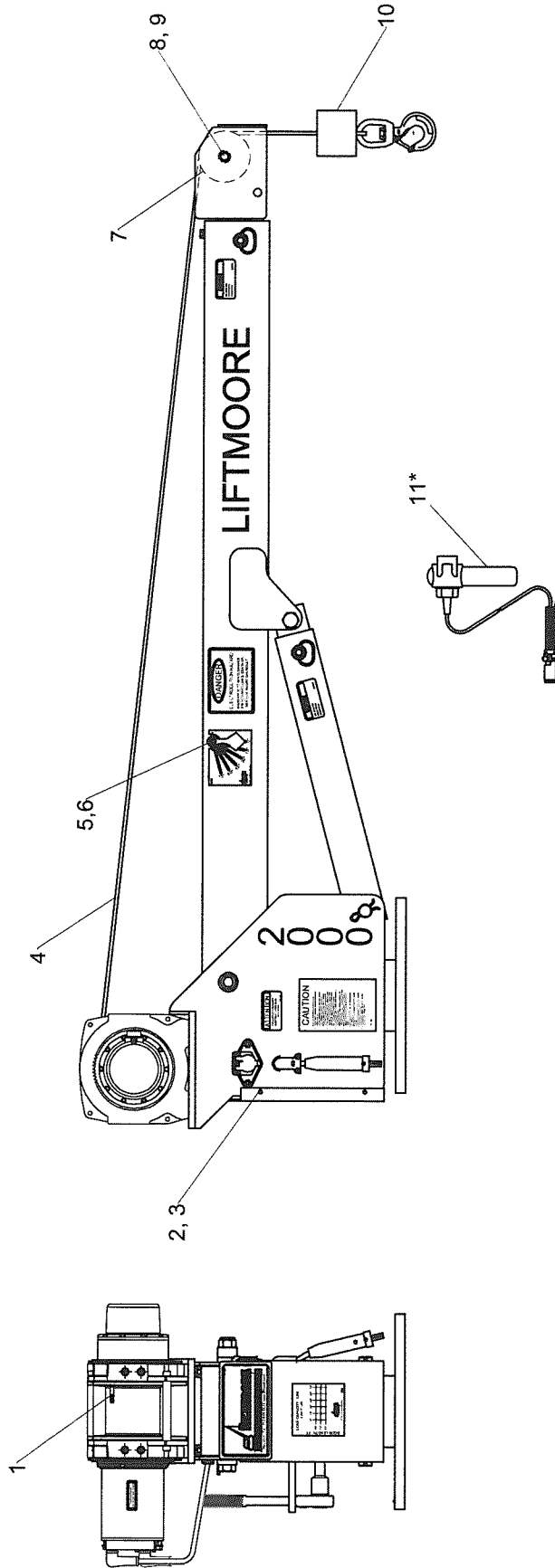

ITEMS WITH \* HAVE DETAIL DRAWINGS

#	PN	DESCRIPTION	QTY	#	PN	DESCRIPTION	QTY	#	PN	DESCRIPTION	QTY
1	70022	WEDGE, WIRE ROPE ANCHOR	1	7	32642	SHEAVE ASSY 3.50PD X 0.25 ROPE	1			NOT SHOWN:	
2	17336	COVER, BACK 2000A (ABS)	1	8	30500	SCREW, HHC 0.50-13 X 2.25 GR8	1			15593	PLATE, SERIAL 2000
3	32589	SCREW, HWHMS 0.25-20 X 0.75	4	9	30835	NUT, HEX NYLOC 0.50-13 GRADE 5	1			31147	DECAL KIT 2000
4	27461	ROPE, WIRE 0.25 X 62' W/HOOK	1	10	30213	PICKLE (WEIGHT) 8 POUNDS	1				
5	22394	PENDULUM, LOAD RADIUS DIA. HD	2	11	30122	CONTROL, PENDANT 206M/2000 4P	1				
6	31017	SCREW, SHOULDER 0.31-18 X 0.75	2								

<p>Houston TX (713)-688-5533 www.liftmoore.com</p>	<p>DRWN BY: JE</p>	<p>CRANE ASSY 2000 W/ WINCH 23872</p>	<p>DRAWING NO. 24188-A</p>
	<p>DATE: 7/27/10</p>		



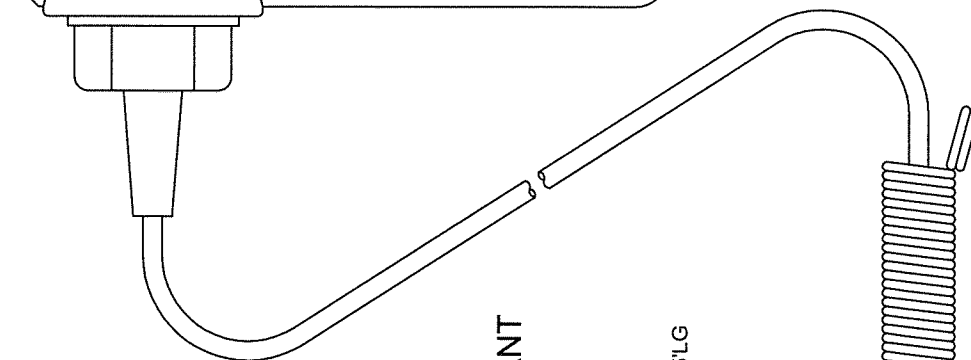
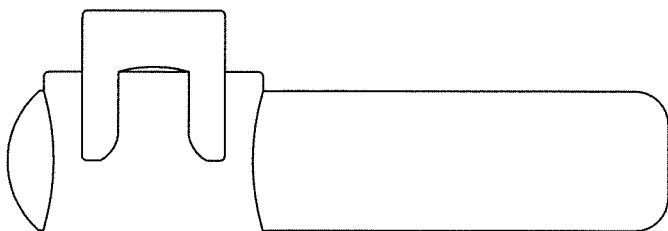
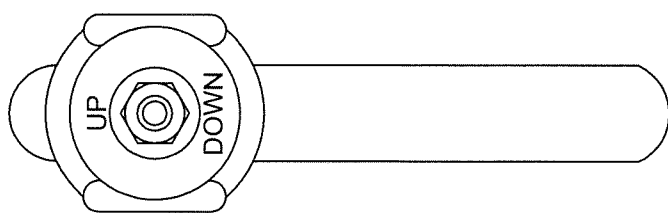

COMPLETE PENDANT

P/N 30122 CONTROL, PENDANT  
206M/2000 4P

PENDANT, LESS PLUG  
P/N 15129 CONTROL, PENDANT BLANK 12.5'LG

REPLACEMENT PLUG  
P/N 30099 PLUG, CONTROL 4-PIN

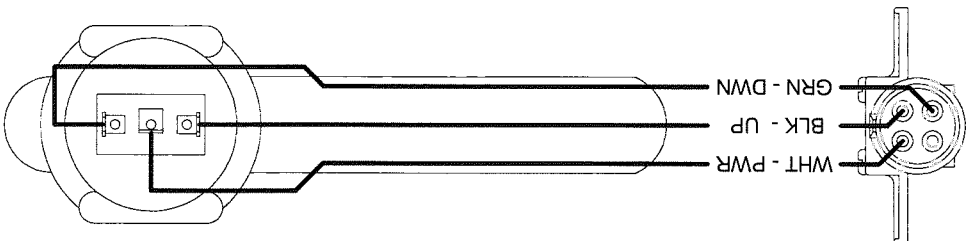

FRONT VIEW

Houston TX  
(713)-688-5533  
www.liftmoore.com

DRWN BY: PDS  
DATE: 4/03/07

CONTROL, PENDANT 206M/2000 4P  
ALSO 2MC, 2000A, 2700AW/WP

DRAWING NO.

30122-C



THIS DRAWING INTENTIONALLY LEFT BLANK

FOR FUTURE ADDITIONS

OR

A PART OR FEATURE IS NOT APPLICABLE TO THIS CRANE



Houston TX  
(713)-688-5533  
[www.liftmoore.com](http://www.liftmoore.com)

DRWN BY:

DATE:

DRAWING NO.

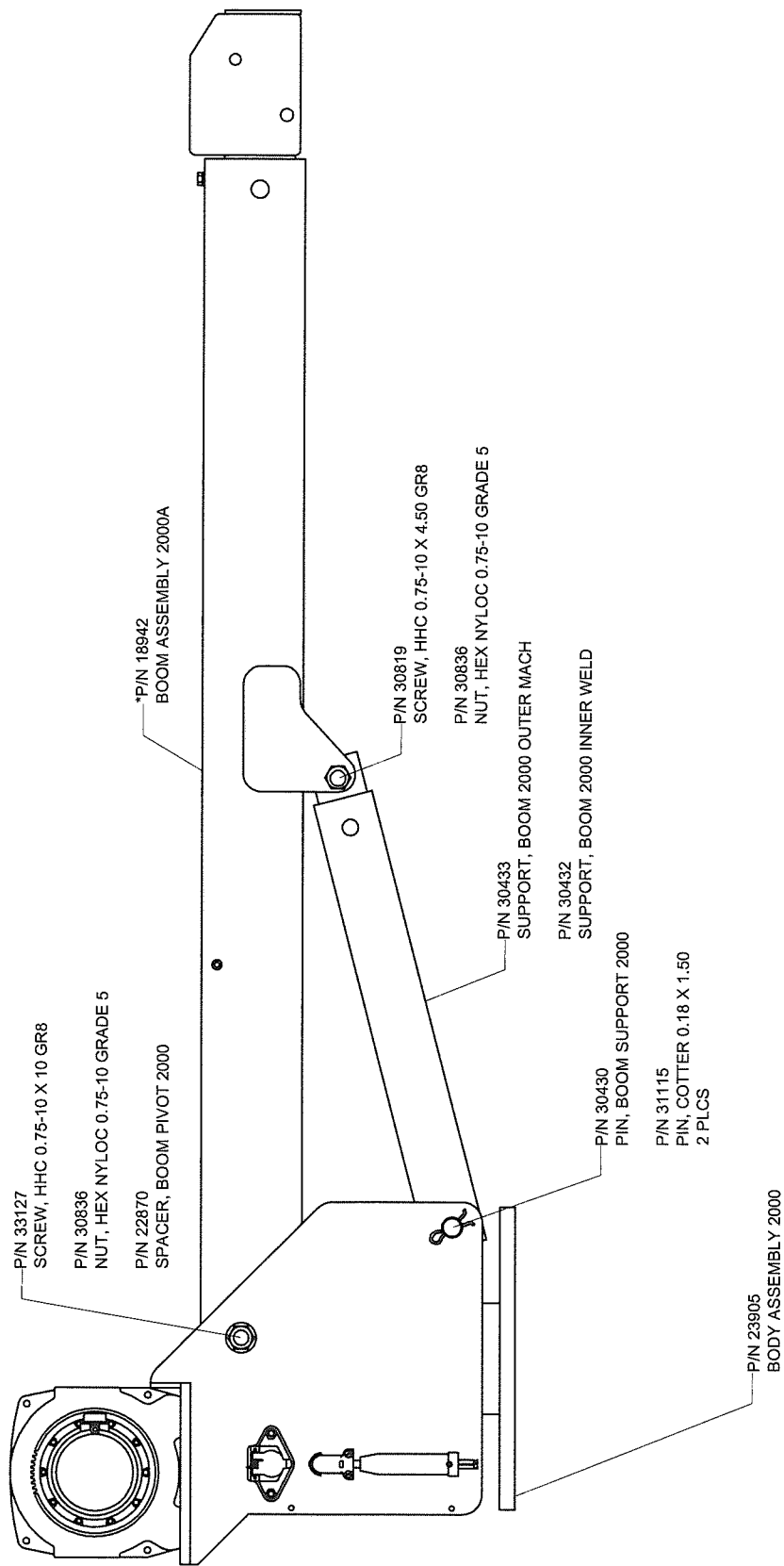

ITEMS WITH \* HAVE DETAIL DRAWINGS

Houston TX  
 (713)-688-5533  
 www.liftmoore.com

DRWN BY: IS

DATE: 7/27/10

BOOM-BODY ASSY 2000

W/ WINCH 23872

DRAWING NO.

23906-0



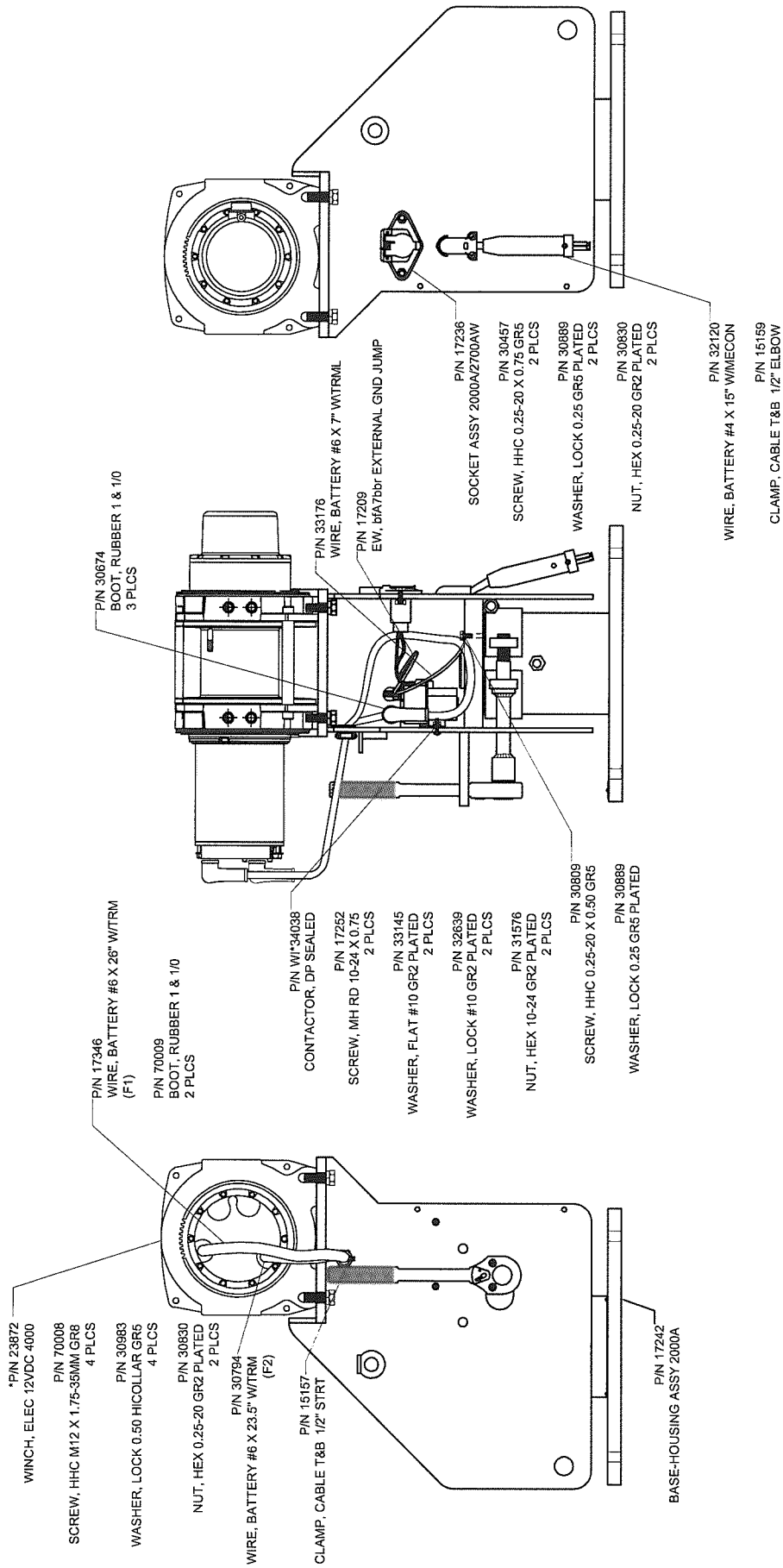

ITEMS WITH \* HAVE DETAIL DRAWINGS

	Houston TX (713)-688-5533 www.liftmoore.com	DRWN BY: IS DATE: 7/27/10	BODY ASSEMBLY 2000 W/ WINCH 23872	DRAWING NO. <b>23905-0</b>
--	---	------------------------------	--------------------------------------	-------------------------------

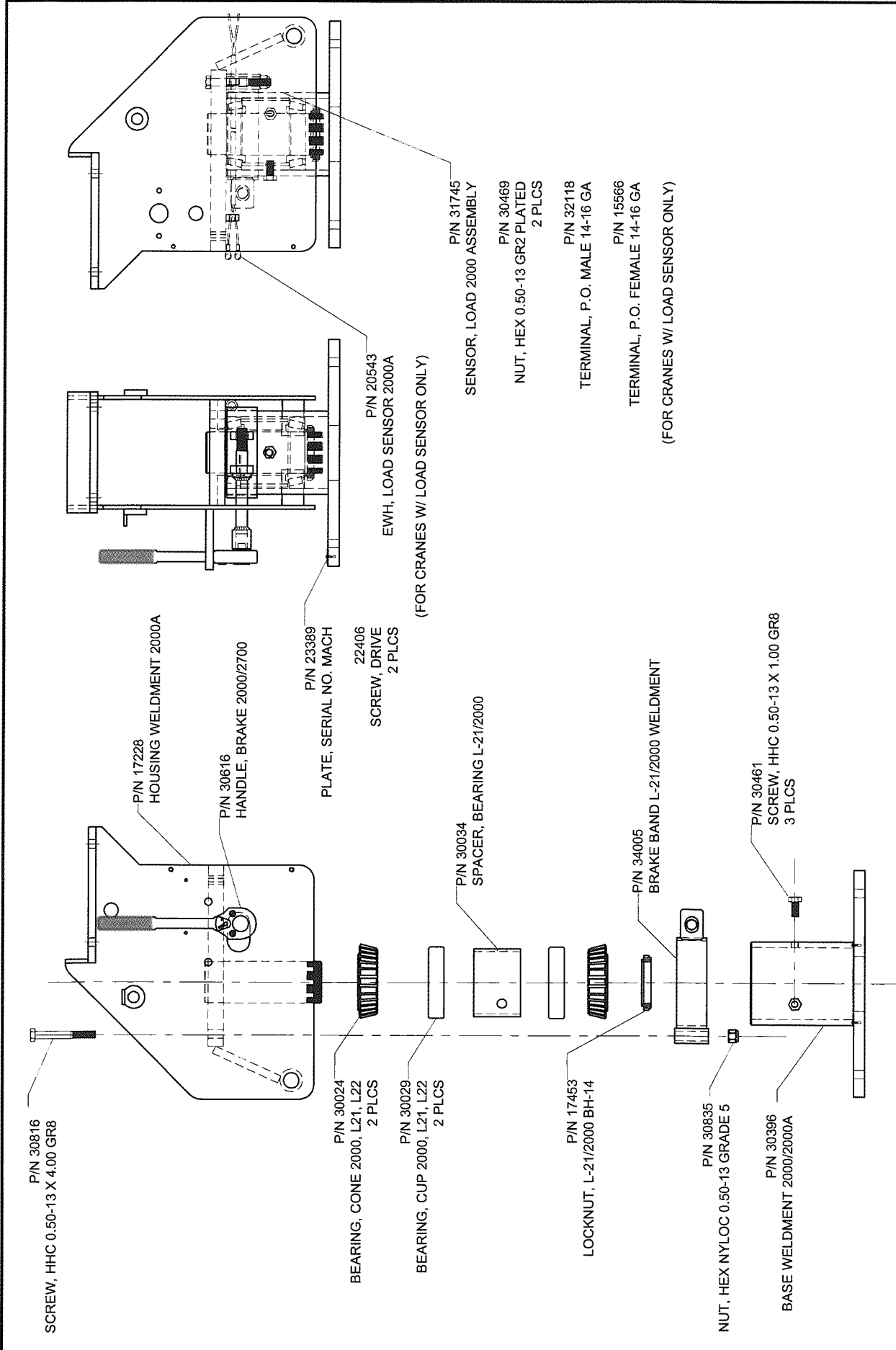

	Houston TX (713)-688-5533 www.liftmoore.com	DRWN BY: JC DATE: 11/20/09	BASE-HOUSING ASSY 2000 A & L.S.	DRAWING NO. <b>50736-B</b>
--	---	-------------------------------	---------------------------------	-------------------------------

P/N 33169  
 SCREW, HHC 0.37-16 X 0.62 GR8

P/N 30467  
 NUT, HEX 0.37-16 GR2 PLATED

P/N 30473  
 WASHER, LOCK 0.37 GR5 PLATED

P/N 34163  
 BUSHING, BOOM PIVOT 2000# CRNS  
 2 PLCS

P/N 17302  
 BOOM, OUTER 2000A WELDMENT

P/N 30435  
 BOOM, INNER 2000/2000A WELD

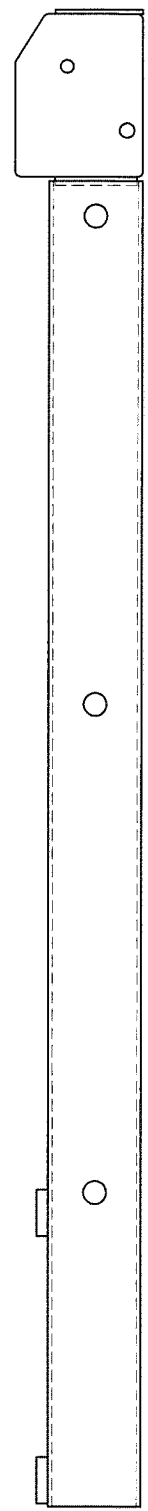
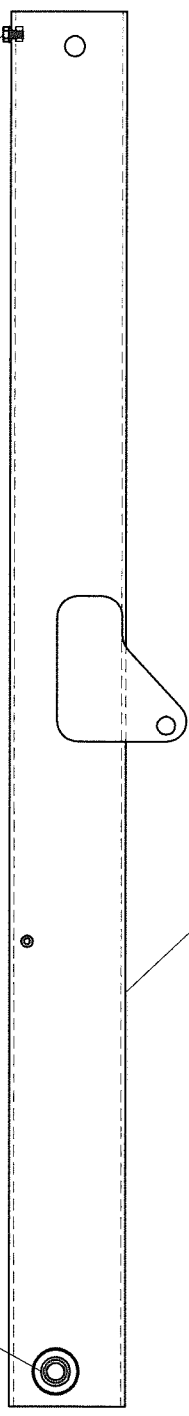

Houston TX  
 (713)-688-5533  
 www.liftmoore.com



**BOOM ASSEMBLY 2000A**

DRAWING NO.

**18942-A**

DRWN BY: JC

DATE: 7/29/08

P/N 33169  
 SCREW, HHC 0.37-16 X 0.62 GR8

P/N 30467  
 NUT, HEX 0.37-16 GR2 PLATED

P/N 30473  
 WASHER, LOCK 0.37 GR5 PLATED

P/N 34163  
 BUSHING, BOOM PIVOT 2000# CRNS  
 2 PLCS

P/N 20292  
 BOOM, OUTER 2000A-14 WELD

P/N 20289  
 BOOM, INNER 2000A-14 WELD

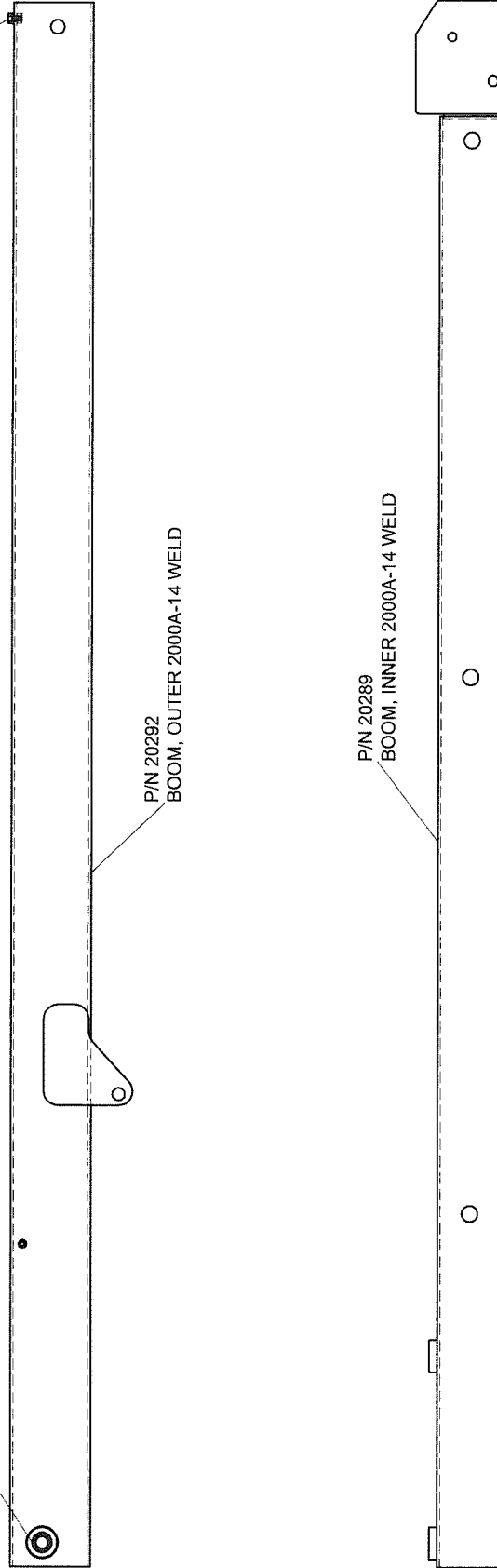

Houston TX  
 (713)-688-5533  
 www.liftmoore.com



BOOM ASSEMBLY 2000A - 14

DRWN BY: JC

DATE: 7/29/08

DRAWING NO.

20293-A

WINCH DC2000 12VDC P/N 23872

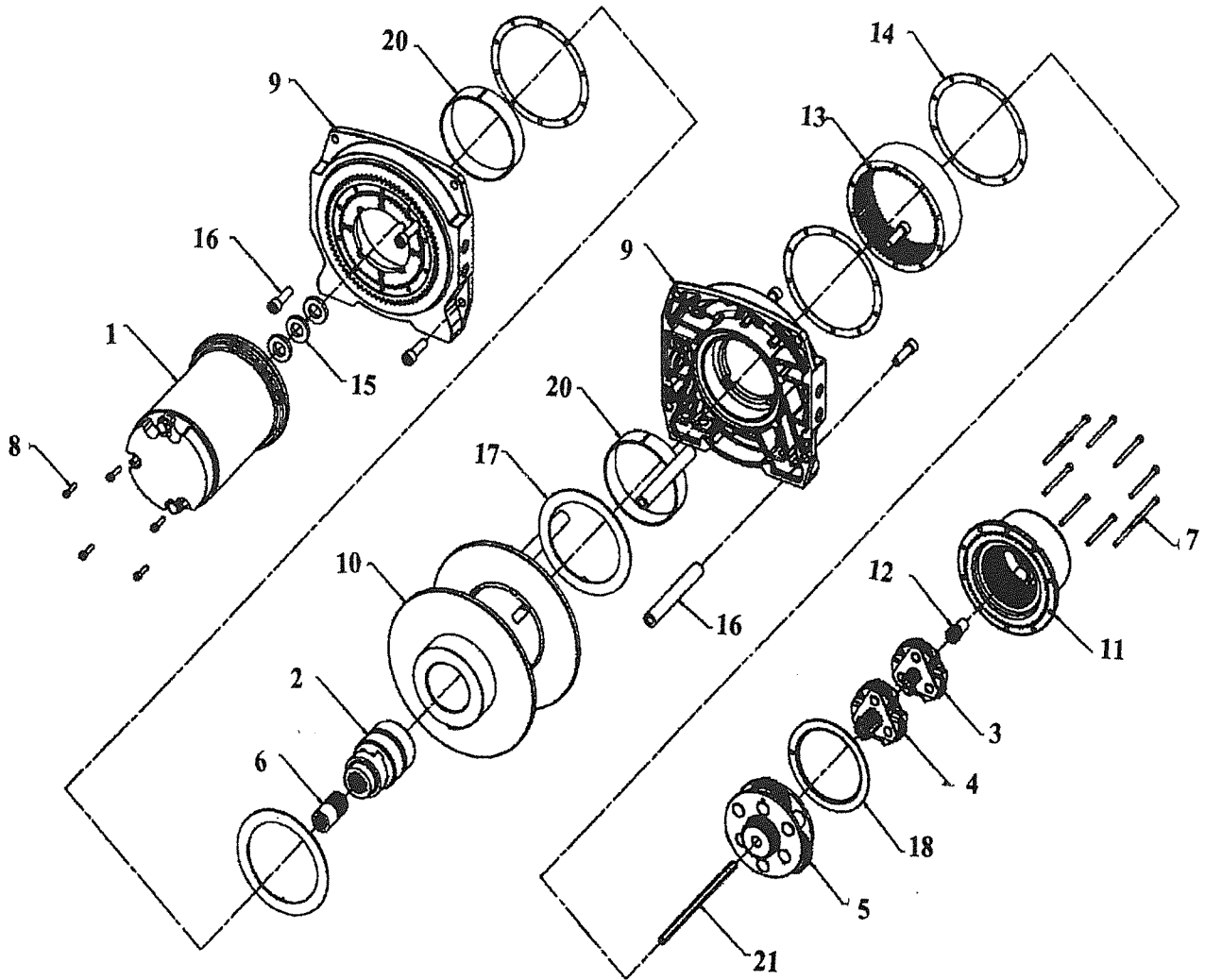



## SERVICE PARTS LIST: DC2000LF HOIST-12V P/N 23872

ITEM REFERENCE		ITEM / KIT No.
1	MOTOR SPLINED 12V DC	WI*84211
2	BRAKE ASSEMBLY DC2000	WI*63550
3	CARRIER ASSY, STAGE 1	WI*28430
4	CARRIER ASSY, STAGE 2	WI*28433
5	CARRIER ASSY, STAGE 3	WI*28115
6	COUPLER, MOTOR/BRAKE	WI*32149
7	CPSCR, 10-24 X 2-1/4-HEX SOCKET HEAD-PI	WI*13850
8	CPSCR, SOC, 10-24 X 3/4, GR9 (KB)	WI*5553
9	(MTO) S/P DRUM SUPPORT, GEAR END	WI*85575
10	DRUM, (KB) 2000-MF, 4.25 DIA	WI*31618
11	SVC KIT END HOUSING SUBASSY, CLUTCH PLUG	WI*85583
12	GEAR, SUN, 12 TOOTH, STAGE 1	WI*13874
13	RING GEAR, ARG, 75 TOOTH	WI*25308
14	HOUSING, GASKET	WI*13848
15	SPACER, MOTOR	WI*15271
16	SVC KIT TIE ROD, ALUMN, .625 X 4.92	WI*85579
17	WASHER, TRUST, NYLATRON, CIM	WI*30277
18	WASHER, TRUST, NYLON, MIDRANGE	WI*13826
19	PARTS PACK, DC2000 HOIST	WI*60049
20	BUSHING DRUM NYLATRON	WI*30274
21	SHAFT-DRIVE-HEX 5/16 X 6.85	WI*84346



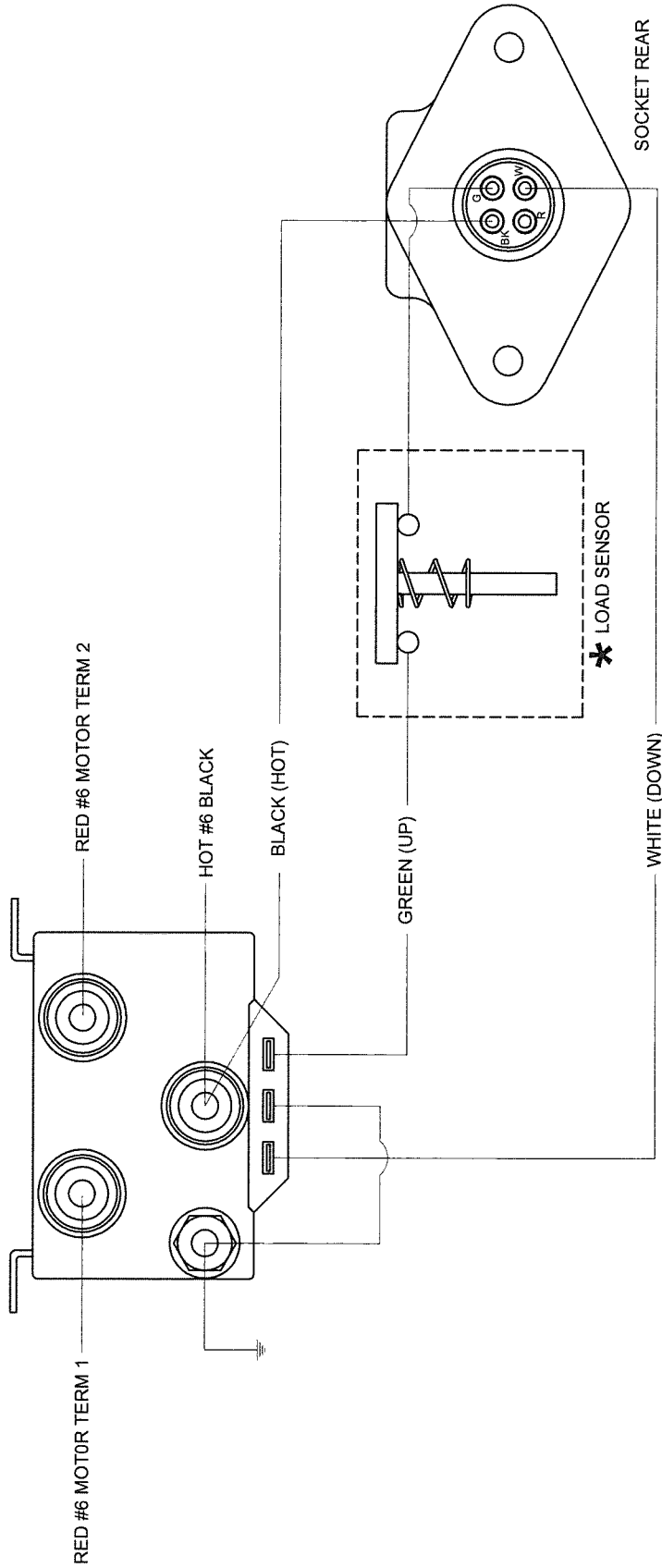

\* LOAD SENSOR (P/N 30678) SUPPLIED WHEN REQUESTED ONLY ON 2000A MODELS

Houston TX  
(713)-688-5533  
www.liftmoore.com



SCHEM, ELEC WIRING 2000A

DRAWING NO.

50386-B

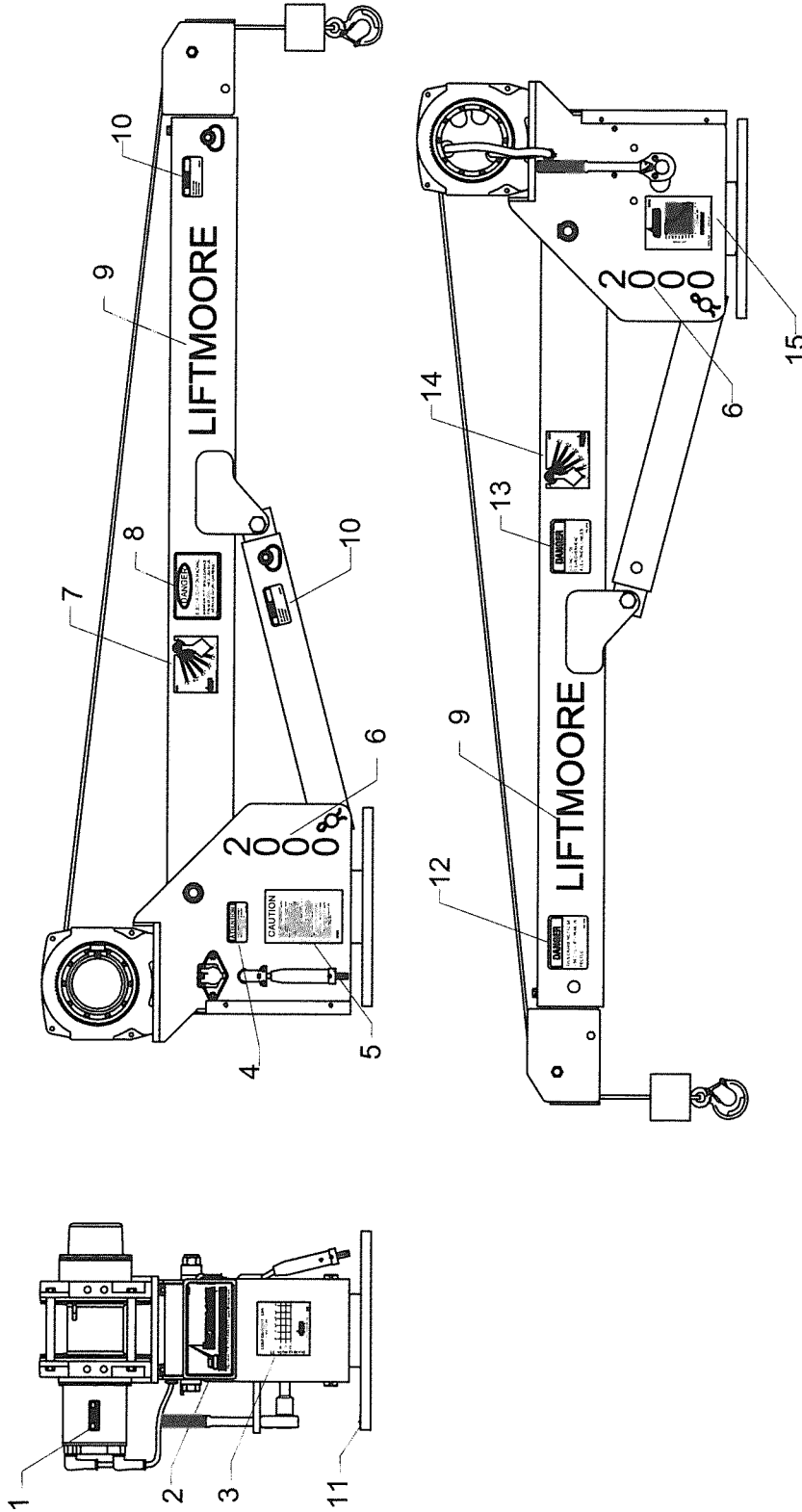

#	PN	DESCRIPTION	QTY	#	PN	DESCRIPTION	QTY	#	PN	DESCRIPTION	QTY
1	32608	DECAL, MOTOR MAGNETS DAMAGE	1	6	15574	DECAL, 2000	2	11	23389	PLATE, SERIAL NO. MACH	1
2	15581	DECAL, LOGO LARGE	1	7	22376	DECAL, ANGLE PENDULUM RIGHT	1	12	32085	DECAL, LIFTING PERSONNEL	1
3	22373	DECAL, LOAD CAPACITY 206	1	8	15618	DECAL, DANGER ELECTRIC INJURY	1	13	15579	DECAL, DANGER CABLES	1
4	15577	DECAL, ATTENTION BATTERY	1	9	34041	DECAL, LIFTMOORE - 2.00"	2	14	22375	DECAL, ANGLE PENDULUM LEFT	1
5	16102	DECAL, CAUTION READ MANUAL	1	10	15612	DECAL, CAUTION PIN MUST BE IN	2	15	15593	PLATE, SERIAL 2000	1



Houston TX  
(713)-688-5533  
www.liftmoore.com

DRWN BY: JC

DATE: 12/30/09

**DECAL DIAGRAM FOR THE**

2000A

DRAWING NO. **58287-A**

THIS PAGE INTENTIONALLY LEFT BLANK



HOUSTON, TEXAS  
FAX: (800) 824-5559 (USA & Canada)  
FAX: (713) 688-6324  
PHONE: (713) 688-5533  
[www.liftmoore.com](http://www.liftmoore.com)

## **LIFTMOORE LIMITED WARRANTY**

### Parts and Structural

Liftmoore, Inc. warrants each LIFTMOORE crane to be free from defects in materials and workmanship for twelve (12) months from the date of delivery to the original customer. Under the terms of this warranty the crane structural components manufactured by LIFTMOORE, Inc. are warranted for thirty-six (36) months from the date of delivery to the original customer. LIFTMOORE, Inc. will repair or replace, as its sole discretion, any equipment or part that is returned f.o.b. to LIFTMOORE, Inc.'s plant at 7810 Pinemont Drive, Houston, Texas 77040, or to one of its authorized dealers, and is found by LIFTMOORE, Inc. or its authorized dealer to have been defective at the time of original delivery.

The foregoing warranty is the exclusive warranty made by LIFTMOORE, Inc. with respect to its cranes and is in lieu of all other warranties. ANY AND ALL OTHER WARRANTIES, EXPRESS OR IMPLIED, INCLUDING ANY WARRANTY OF MERCHANTABILITY OR FITNESS OF ANY CRANE FOR A PARTICULAR PURPOSE OR OPERATION, ARE HERBY EXPRESSLY DISCLAIMED.

The foregoing warranty applies only to LIFTMOORE cranes under normal use and service and does not apply in the event of damage caused by repair or alteration or damage during shipment, accident, negligence, overloading, or misuse, including operator's failure to follow any of the instructions issued with the crane.

This warranty is limited to the original purchaser and is not assignable. In order to submit a claim, the original purchaser must provide a copy of the original invoice for the crane in question within twelve (12) months following the delivery date and within 30 days from the date of repair.

The warranty applies only when the LIFTMOORE crane is used for commercial purposes and does not cover any purchase for use for personal, family or household purposes.

**LIMITATION OF LIABILITY:** LIFTMOORE, Inc.'s liability for any losses or damages resulting from any cause whatsoever, including LIFTMOORE, Inc.'s NEGLIGENCE or from a defective crane irrespective of whether such defects are discoverable or latent, shall in no event exceed the purchase price of the crane to which losses or damages are claimed, or at the election of LIFTMOORE, Inc., the repair or replacement of the defective crane.

In no event shall LIFTMOORE, Inc. be liable for any special, incidental, or consequential damages, including commercial losses or costs of any kind sustained by purchaser or any other person or for any damages for which purchaser may be liable to other persons by reason of any defect in any LIFTMOORE crane or any part thereof.

LIFTMOORE, Inc. reserves the right to make changes in design or construction of its cranes at any time without obligating itself to make such changes on cranes previously manufactured.

No agent, employee, or representative of LIFTMOORE, Inc. has authority to amend or modify the foregoing warranty or to bind LIFTMOORE, Inc. by any other warranty, guaranty, or assumption of liability.

In the event any provision of this warranty is for any reason held ineffective, the remaining provisions shall remain in full force and effect.

Some states do not allow limitations on how long an implied warranty lasts or the exclusion or limitation of incidental or consequential damages, so the above limitations and exclusions may not apply to you. This warranty gives you specific legal rights, and you may also have other legal rights that vary from state to state.

