

TABLE OF CONTENTS
 USERS MANUAL P/N 22302
 206R & WR GS
 ELECTRIC ROTATION & GAS SPRING

SECTION I
GENERAL OPERATION, INSPECTION, AND MAINTENANCE

CRANE SAFETY RULES	F1122-B	1-1
INTRODUCTION	F1111-D	1-3
OPERATING RESTRICTIONS	F1449-0	1-4
OPERATING PRACTICES.....	F1449-0	1-4
INSPECTION AND MAINTENANCE.....	F1113-C	1-7
MONTHLY INSPECTION REPORT	F1448-0	1-9
STANDARD HAND SIGNALS FOR CRANE OPERATIONS ..	F2409-0	1-11

SECTION II
OPERATION AND TROUBLESHOOTING

CRANE OPERATION.....	F1233-0.....	2-1
----------------------	--------------	-----

SECTION III
CRANE SPECIFICATION

LIFTING CAPACITIES	F1235-D	3-1
POWER FUNCTIONS AND SPEEDS	F1235-D	3-1
BOLT AND LUBRICATION SPECS.....	F1235-D	3-2

SECTION IV
PARTS

BOX PARTS LIST.....	F1480-C	4-1
CRANE ASSEMBLY	DWG.58256-E.....	4-3
PENDANT CONTROL	DWG.21014-D	4-4
TRAVEL BLOCK ASSEMBLY	DWG.22599-0	4-5
BOOM-BODY ASSEMBLY	DWG.50721-A	4-6
GAS SPRING ASSEMBLY.....	DWG.21273-A	4-7
BODY ASSEMBLY.....	DWG.20987-B	4-8
BASE-HOUSING ASSEMBLY	DWG.20986-E.....	4-9
ROTATOR ASSEMBLY.....	DWG.21485-B	4-10
ELECTRICAL SWIVEL.....	DWG.50471-E.....	4-11
BOOM ASSEMBLY – 206	DWG.22222-A	4-12
BOOM ASSEMBLY – 206W	DWG.19633-B	4-13
WINCH 1200.....	DWG.22289-A	4-14



TABLE OF CONTENTS
USERS MANUAL P/N 22302
206R & WR GS
ELECTRIC ROTATION & GAS SPRING

WINCH 4000.....	DWG.22803-A	4-15
ELECTRICAL SCHEMATIC.....	DWG.50539-B	4-16
DECAL DIAGRAM.....	DWG.58283-C	4-17
WARRANTY.....	F1442-A	



CRANE SAFETY RULES

CAUTION!

1. READ AND UNDERSTAND OPERATOR'S MANUAL.
2. INSPECT VEHICLE AND CRANE, INCLUDING ITS OPERATION, BEFORE DAILY USE.
3. USE THIS EQUIPMENT ONLY ON SOLID LEVEL GROUND WITH OUTRIGGERS OR JACKSTANDS PROPERLY SET.
4. BEFORE OPERATING THE CRANE REFER TO MAXIMUM LOAD CHART ON CRANE FOR OPERATING LOAD LIMITS.
5. BE SURE LOAD BEING LIFTED IS WITHIN SAFE WINCH CAPACITY AS WELL AS SAFE CRANE CAPACITY. MULTI-PART LINE OPERATION IS REQUIRED WHEN SINGLE LINE LOAD CAPACITY OF WINCH IS EXCEEDED.
6. DO NOT OPERATE, WALK, OR STAND UNDER THE BOOM OR ANY SUSPENDED LOAD.
7. ALWAYS PAY OUT LOAD LINE BEFORE EXTENDING BOOM. WIRE ROPE DAMAGE AND / OR BREAKAGE MAY OCCUR.
8. BOOM MUST BE IN ITS REST BEFORE MOVING VEHICLE.
9. BOOM TIP MUST BE DIRECTLY OVER THE LOAD BEFORE ANY LIFTING IS STARTED. DO NOT DRAG LOADS WITH THIS CRANE.
10. MAINTAIN THIS CRANE AS REQUIRED IN THE OWNER'S MANUAL.
11. DO NOT ALLOW PERSONNEL TO RIDE ON THE LOAD LINE, LOAD, OR BOOM OF THIS CRANE.
12. IT IS UNLAWFUL TO OPERATE THIS EQUIPMENT WITHIN TEN FEET OF HIGH VOLTAGE LINE



THIS PAGE INTENTIONALLY LEFT BLANK



F1122-B
5/12/08

HOUSTON, TEXAS
FAX: (800) 824-5559 (USA & Canada)
FAX: (713) 688-6324
PHONE: (713) 688-5533
www.liftmoore.com

INTRODUCTION

This crane is a powerful machine designed to lift and move heavy loads. There are many hazards associated with these operations. Liftmoore has designed this crane to be as safe as possible but -

IT IS THE OPERATOR'S RESPONSIBILITY TO PREVENT ACCIDENTS!

This takes pre-planning, attention, and knowledge of basic principles and rules. Even if you have used similar cranes, reading this manual in its entirety will help prevent damage, injury, or even loss of life; benefits well worth the short amount of time it takes to read these pages.

REGULATORY AUTHORITY

Use of this crane is governed by OSHA 29 CFR 1910.180 and may be governed by other federal, state, or local regulations.

IT IS THE OPERATOR'S RESPONSIBILITY TO UNDERSTAND AND COMPLY WITH ALL APPLICABLE REGULATIONS GOVERNING THE OPERATION, INSPECTION, AND MAINTENANCE OF THIS CRANE.

Personnel should be trained, tested, and certified, as recommended by OSHA and ANSI standards, before operating this crane.

USING THIS MANUAL

This manual assumes that the crane is mounted on a typical service body type or similar truck, which is powered by the vehicle electrical or hydraulic system, and is controlled by either the standard pendant control or FM radio control sold by Liftmoore, Inc.

This manual is supplied to provide basic guidelines for the safe use, routine maintenance, and general inspections of this crane.

Laws, regulations, standards, or policies may be more restrictive than this manual. If a conflict exists for any limit or condition, the safest or most prohibitive shall be used. Under no circumstances shall the load, moment, or stability ratings be exceeded.

Pay particular attention to the following:

WARNING! – Draws attention to hazards, conditions, or procedures that if not observed could result in injury or death.

CAUTION! – Draws attention to hazards, conditions, or procedures that if not observed could result in damage to the crane, load, or other equipment. Equipment failure could in turn lead to injury or death.

NOTE! – Draws attention to conditions or procedures that are essential to emphasize.

For questions, interpretations, or to report errors, please contact Liftmoore, Inc, Engineering Dept.



OPERATING PRACTICES

OPERATING RESTRICTIONS

DUTY CYCLE

For Electric Cranes the duty cycle time should be limited to 10%. This is limited by heat buildup in the motors and declining charge in the batteries. (Installing extra batteries near the crane helps keep the voltage at maximum.)

PERSONNEL

LIFTING OR MOVING OF PERSONNEL IS STRICTLY PROHIBITED! This crane was neither designed nor intended to lift personnel. Under no circumstances should anyone be allowed to ride on the crane, line, or load. All non-essential personnel must be kept away when using the crane. The load must never be moved over people, nor must anyone be allowed to pass or stand under a suspended load.

ELECTRICAL LINES

Consult ANSI B30.5 for operating procedures, minimum safe distances, and prohibited zones when working around electrical lines or poles.

When operating near electrical power lines, the crane must be positioned so that the distance from the crane to the lines or poles is equal to or greater than the length of the fully extended boom plus the minimum safe distance required.

All parts of the crane, line, and load must be kept a minimum safe distance from electrical power lines and poles. This distance is 10 feet for electrical lines carrying 50kV or less.

UNDER NO CIRCUMSTANCES SHOULD A CRANE BE OPERATED UNDER ELECTRICAL POWER LINES.

SETUP

POSITION The vehicle must be positioned so that the load is kept as close to the crane base as possible to reduce the moment on the crane. Consideration must be given to starting and ending position as well as firmness and slope of the ground and any obstructions.

OUTRIGGERS The outriggers or jackstands must be firmly set and the vehicle as level as possible. This will reduce the stresses on the rotation drive and keep the load off the vehicle's suspension. Keep in mind that the weight on the vehicle will shift as the crane and load are rotated.

LOAD LIMIT The operator must understand the crane load chart. The operator must ensure that the load is within the load limits over the entire range which it will be moved. Be sure to include the weight of any lifting devices including the travel block.

The load limit chart is attached to the side of the crane to aid the operator.

The boom angle indicator and chart aids the operator in determining the load capacity at various boom angles and extensions. It also gives the load limit at that configuration.

STABILITY The operator is responsible to verify that the truck is stable at any area where the Crane is rotated.

TRAVEL BLOCK The operator must determine if the load is within the single line compatibility of the winch or if a multi-part line configuration is needed.



REEVING Ensure the proper routing of the rope through the sheaves and travel block. The rope must lie in the sheave groove and must not rub against any metal objects.

Ensure the rope is correctly wound on the winch drum. The crane assembly drawing will indicate if the rope must be wound over the top or bottom of the drum. The rope must never contact any part of the winch mounting.

WARNING!

If the winch winding direction is reversed the brake will not work and the load will fall.

ATTACHING THE LOAD

POSITION The boom tip must be moved over the load before lifting so that it will be lifted straight up.

CAUTION!

Never drag a load with the crane. Dragging a load puts very high stresses on the crane for which it was not designed.

ROPE Check the rope condition to ensure it is not frayed or damaged. Ensure that the rope is not kinked and that it does not contact any sharp edges or make any sharp bends.

If using double line configuration, ensure that the lines are not twisted.

CAUTION!

Never wrap the hoist rope around the load! Serious damage to the rope WILL occur.

HOOK Always make sure the load is applied to the throat of the hook. Never use a bent hook.

CAUTION!

Always lift with the throat of the hook. Never lift with the load applied to the tip of the hook. Doing so will bend the hook.

SLINGS If the load does not have a lifting eye, use a nylon, chain, or other type of sling designed for lifting and rated for loads greater than that being lifted.

BALANCE Ensure the load will be secure and balanced when lifted. Ensure that the load cannot shift in the sling and that the sling cannot slide across the hook should the load become unbalanced.

LIFTING THE LOAD

Before lifting, ensure that the load is free from all mountings and is no way attached or stuck to anything.

Ensure that at least five full wraps remain on the winch drum at all times.

Test the winch brake by lifting the load a few inches and ensuring that it does not slip.

HOLDING THE LOAD

The operator must keep the load in sight at all times once it is lifted.



1-6

The operator must never leave the controls once the load is lifted.

The operator must ensure that no one is allowed to pass or stand under a suspended load.

CAUTION!

Never move the vehicle with a suspended load. Doing so will put dynamic loads on the crane for which it was not designed.

MOVING THE LOAD

Before moving the load, make sure the path is free of any obstructions or people.

Avoid sudden accelerations or stops. Speeds must be kept to a minimum, especially rotation, to keep the load from swinging.

Avoid sudden reversing of direction. Do not reverse direction while the load is still moving.

Make sure the that no part of the crane, boom, or load makes contact with any obstruction or comes within a minimum of ten feet from any electrical line.

TRANSIT

While in transit, the crane must be stowed, preferably in a boom rest. The crane must be prevented from rotating and the hook prevented from swinging.



INSPECTION AND MAINTENANCE

OSHA and ANSI require frequent and periodic inspections. Records of these inspections must be kept readily available. Liftmoore requires periodic maintenance to ensure proper operation and prolonged life of the crane.

INSPECTION

DAILY INSPECTION

OSHA 29CFR 1910.180 (d)(2)(i) requires the following be checked daily prior to use:

- All control mechanisms for maladjustment interfering with proper operation as well as for excessive wear of components and contamination by lubricants or other foreign matter.
- All safety devices for malfunction. This should include the anti-two block and pressure switch.
- Deterioration or leakage in air or hydraulic systems.
- Crane hooks with deformations or cracks. For hooks with cracks or having more than 15 percent in excess of normal throat opening or more than 10 deg. twist from the plane of the unbent hook.
- Electrical apparatus for malfunctioning, signs of excessive deterioration, dirt, and moisture accumulation. This should include the battery terminals, master disconnect switch, electrical swivel
- The wire rope shall be replaced if any of the following conditions are noted:
 - Kinking, crushing, bird-caging, or other damage
 - Reductions from nominal diameter of more than one-sixty-fourth inch for diameters up to and including five-sixteenths inch, one-thirty-second inch for diameters three-eighths inch to and including one-half inch.
 - Thimble is not in place or is damaged
 - Any evidence of heat damage
 - Six or more randomly distributed broken wires in 1 lay
 - Three or more broken wires in 1 strand in 1 lay

MONTHLY INSPECTION

A thorough inspection of all ropes in use shall be made at least once a month and a certification record which includes the date of inspection, the signature of the person who performed the inspection and an identifier for the ropes shall be prepared and kept on file where readily available. All inspections shall be performed by an appointed or authorized person. Any deterioration, resulting in appreciable loss of original strength shall be carefully observed and determination made as to whether further use of the rope would constitute a safety hazard. Some of the conditions that could result in an appreciable loss of strength are the following:

- Reduction of rope diameter below nominal diameter due to loss of core support, internal or external corrosion, or wear of outside wires.
- A number of broken outside wires and the degree of distribution of concentration of such broken wires.
- Worn outside wires.



- Corroded or broken wires at end connections.
- Corroded, cracked, bent, worn, or improperly applied end connections.
- Severe kinking, crushing, cutting, or unstranding.

PERIODIC INSPECTION

An Annual Inspection Form is included in this manual. OSHA 29CFR 1910.180 (d)(2)ii) requires periodic inspections of this crane. Liftmoore recommends an annual inspection using the included form.

MAINTENANCE PRECAUTIONS

Before any maintenance is performed, the vehicle should be out of the way and the crane secured.

WARNING!

Never perform any maintenance while the crane has any type of load on it. Use the manual operation procedure to lower the load if necessary.

WARNING!

Hydraulic cylinders may have high pressure stored in them even after hydraulic power is removed.

The counterbalance and pilot operated check valve in the cylinder will always hold some pressure in the cylinder. Slightly extending the cylinder then retracting a small amount will relieve most of the pressure in the cylinder. **DO NOT DEADHEAD THE CYLINDER!** This will store the maximum amount of pressure in the cylinder. Care should be taken when either valve is removed from the cylinder as some pressure will still remain.

After any maintenance has been performed the crane shall not be operated until all guards have been reinstalled, all safety devices reactivated, and maintenance equipment removed.

LUBRICATION Refer to the crane specification section for the periodic maintenance schedule and type of lubrication required.

BOLTS Bolts may loosen over time due to vibration; therefore they should be checked periodically. If bolts need to be replaced, make sure they are replaced with bolts of equal or greater strength. Check the periodic maintenance schedule (Crane Specification Section) for bolt specification and torque.

NOTE!

Sheave and boom and cylinder pivot bolts are not standard bolts. The shank and thread length of these bolts have been modified so that they do not pivot on the threads. Consult the parts section of this manual for part numbers of these bolts.

OTHER MAINTENANCE

Refer to parts drawings for any specific maintenance or adjustment procedures such as hydraulic winch brake, rotation drive gear set adjustment, ect.



MONTHLY INSPECTION REPORT

Manual Boom Extension

Crane Model No. _____ **Serial Number** _____

- Are Boom Hitch Pins and Keepers in place? Yes _____ No _____
- Wire Line Hook with Safety Latch Working? Yes _____ No _____
- Is Hook OK, (Not bent)? Yes _____ No _____
- Is Thimble on Wire Rope OK? Yes _____ No _____
- Does Traveling Block function correctly? Yes _____ No _____
- Is Wire Rope OK, not kinked or frayed? Yes _____ No _____
- Are all Boom Sections straight? Yes _____ No _____
- Are Sheave Bolts in place and tight? Yes _____ No _____
- Do all Sheaves rotate easily? Yes _____ No _____
- Are Mounting Bolts torqued correctly? Yes _____ No _____
- Is Boom Angle Indicator in place and functioning,
and is Chart legible? Yes _____ No _____
- Are Cylinder or Boom Support Mounting Bolts secure? Yes _____ No _____
- Are Winch Mounting Bolts tight? Yes _____ No _____
- When stopped, does winch down drift less than 1.0 Inches? Yes _____ No _____
- Is Load Chart in place and easily read? Yes _____ No _____
- Are functions on Pendant operating correctly? Yes _____ No _____
- Is Hydraulic Reservoir full? Yes _____ No _____
- Is Outrigger or jackstand straight and functioning? Yes _____ No _____

Any items checked 'No' must be repaired before using this crane.



THIS PAGE INTENTIONALLY LEFT BLANK





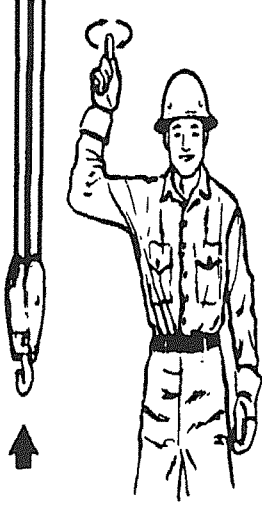
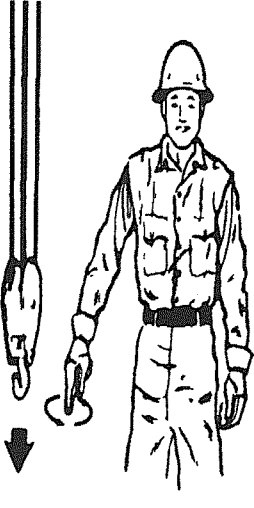
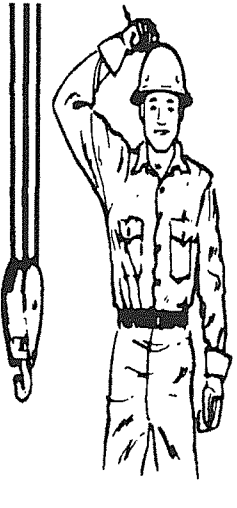
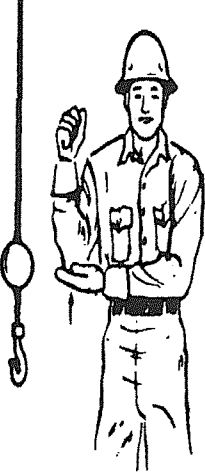
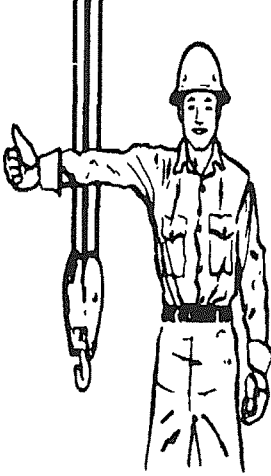
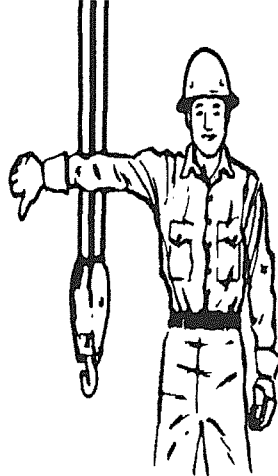

HOUSTON, TEXAS
FAX: (800) 824-5559 (USA & Canada)
FAX: (713) 688-6324
PHONE: (713) 688-5533
www.liftmoore.com

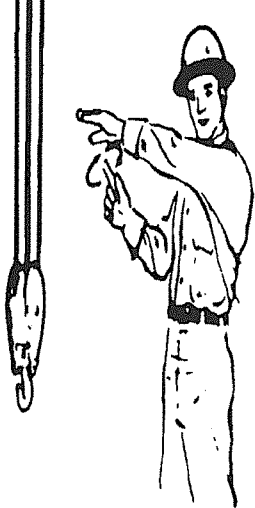
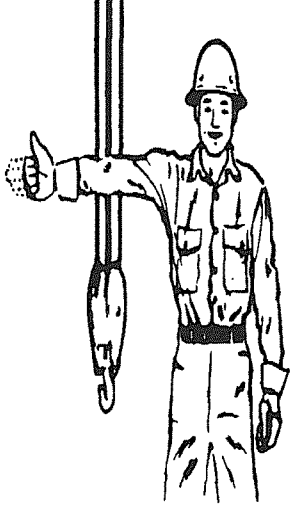
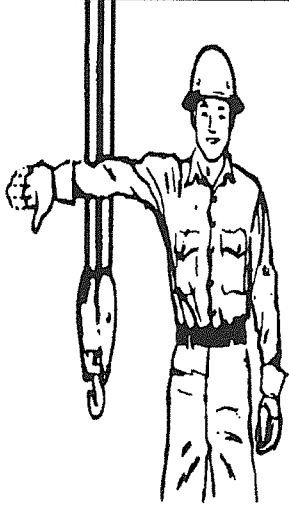
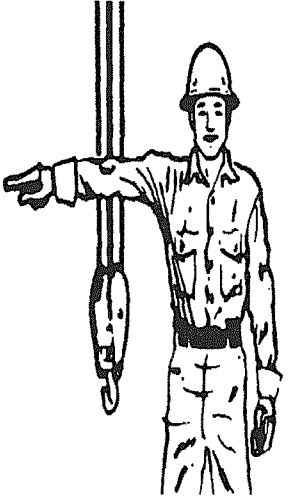
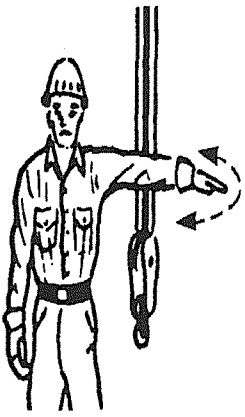
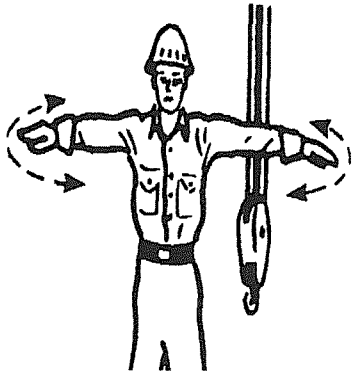
STANDARD HAND SIGNALS FOR CONTROLLING CRANE OPERATIONS

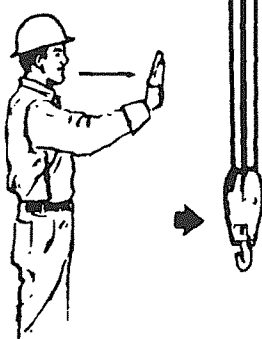
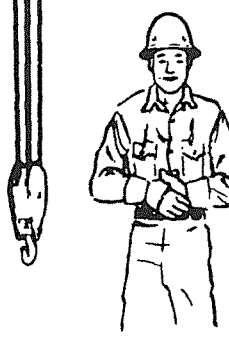
 <p>HOIST. With forearm vertical, forefinger pointing up, move hand in small horizontal circle.</p>	 <p>LOWER. With arm extended downward, forefinger pointing down, move hand in small horizontal circle.</p>	 <p>USE MAIN HOIST. Tap fist on head; then use regular signals.</p>
 <p>USE WHIPLINE (Auxiliary Hoist). Tap elbow with one hand; then use regular signals.</p>	 <p>RAISE BOOM. Arm extended, fingers closed, thumb pointing upward.</p>	 <p>LOWER BOOM. Arm extended, fingers closed, thumb pointing downward.</p>

 <p>MOVE SLOWLY. Use one hand to give any motion signal and place other hand motionless in front of hand giving the motion signal. (Hoist slowly shown as example.)</p>	 <p>RAISE THE BOOM AND LOWER THE LOAD. With arm extended, thumb pointing up, flex fingers in and out as long as load movement is desired.</p>	 <p>LOWER THE BOOM AND RAISE THE LOAD. With arm extended, thumb pointing down, flex fingers in and out as long as load movement is desired.</p>
 <p>SWING. Arm extended, point with finger in direction of swing of boom.</p>	 <p>STOP. Arm extended, palm down, move arm back and forth horizontally.</p>	 <p>EMERGENCY STOP. Both arms extended, palms down, move arms back and forth horizontally.</p>

 <p>TRAVEL. Arm extended forward, hand open and slightly raised, make pushing motion in direction of travel.</p>	 <p>DOG EVERYTHING. Clasp hands in front of body.</p>	 <p>TRAVEL (Both Tracks). Use both fists in front of body, making a circular motion about each other, indicating direction of travel, forward or backward. (For land cranes only.)</p>
 <p>TRAVEL. (One Track) Lock the track on side indicated by raised fist. Travel opposite track in direction indicated by circular motion of other fist, rotated vertically in front of body. (For land cranes only.)</p>	 <p>EXTEND BOOM (Telescoping Booms). Both fists in front of body with thumbs pointing outward.</p>	 <p>RETRACT BOOM (Telescoping Booms). Both fists in front of body with thumbs pointing toward each other.</p>

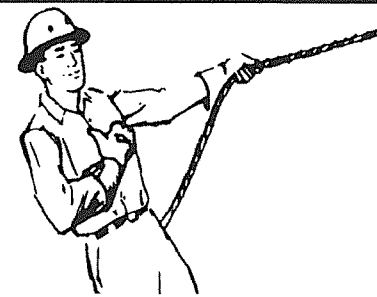
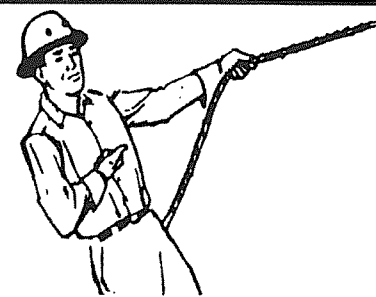
 <p>EXTEND BOOM (Telescoping Boom). One Hand Signal. One fist in front of chest with thumb tapping chest.</p>	 <p>RETRACT BOOM (Telescoping Boom). One Hand Signal. One fist in front of chest, thumb pointing outward and heel of fist tapping chest.</p>
---	---

THIS PAGE INENTIONALLY LEFT BLANK



206R OPERATION

PENDANT CONTROL

All user inputs are facilitated by the remote pendant control. The pendant control plug mates with the crane control socket.

Hoist and Rotation function switches activate the respective motor through electrical contactors located inside the crane housing.

OPERATION

Raise the cover on the crane control socket and plug in the pendant. Ensure all pins are straight and free of dirt, moisture, and corrosion.

NOTE!

The control socket cover locks the plug in the socket and must be lifted to unplug the pendant.

Select the function switch and direction as indicated on the label for the desired operation.

CARE AND MAINTENANCE

The pendant control is designed to be as rugged and maintenance free as possible; however, care should be used in handling and storage as it is expensive to replace.

Follow these simple practices:

- Keep the pendant out of the weather
- When not in use, store the pendant inside the vehicle
- Do not wrap the wire too tightly as internal damage to the wires may result
- Do not place sharp or heavy objects on the cord

NOTE!

The pendant is designed to be weatherproof not waterproof. It may be used in inclement weather, but if left outside or where water can puddle, water can seep inside.

Maintenance should be limited to routine inspection of the plug, wire, and fasteners.

ELECTRICAL SYSTEM

This crane is powered by the vehicle electric system. Electrical power is connected at the crane base and is transferred to the housing through an electrical swivel. The swivel allows for continuous, unlimited rotation of the crane.

Rotation and hoist motor activation and direction are controlled by a double pole, double throw electrical contactor. The contactors are energized by control voltage from the pendant control switches.

CIRCUIT BREAKER

A circuit breaker is supplied with the crane and should be installed as close to the battery as possible.

DISCONNECT SWITCH

A power disconnect switch is supplied with the crane. Disconnecting the power will prevent inadvertent or unauthorized use and help prevent corrosion at electrical connections.

SAFETY SYSTEM

This crane does not have a load limiting or ATB safety system.

It is the operator's responsibility to understand and strictly adhere to the load limits of the crane. The operator must also know the weight of any objects to be lifted.

The operator must always be aware of the hook and travel block position and ensure that the crane is never two-blocked (allowing the travel block or hook to contact the crown plate.)



POWERED FUNCTIONS

CAUTION!

Both the hoist and rotation motors are limited duty and should not be used continuously for long periods of time. Usage must be limited to 5 minutes out of every 25 minutes or motor damage will result.

ROTATION

The crane rotates on a sealed gear bearing. The rotation drive is powered by an electrical motor through a double worm drive.

HOIST

The boom mounted hoist is electrically powered in both the up and down direction. An internal brake prevents the load from falling.

CAUTION!

The hoist brake only functions in one direction. Ensure the winding direction is not reversed by either running the rope all the way out or the rope becoming tangled on the drum. If the winding direction is reversed the brake will not function and the load will fall.

MANUAL FUNCTIONS

ELEVATION

The boom angle may be manually adjusted between 0° to 75°. The boom must be adjusted before lifting the load. An internal gas spring is installed in the boom support to aid in lifting the boom. A handle is provided to aid in raising or lowering the boom.

WARNING!

Do not stand under the boom when adjusting the boom angle. If the boom falls serious injury or death may result.

WARNING!

The boom and support bar can form a pinch point. When adjusting the boom angle use the provided handle and be aware of the moving parts or hand injury may result.

CAUTION!

All boom support pins must be in place before lifting the load. The gas spring will not support a load. If proper boom pins are not installed the boom may collapse under load causing serious damage and possible injury or death.

CAUTION!

The gas spring is under pressure. The gas spring is not a serviceable part and no maintenance or adjustment should be attempted.

WARNING!

The gas spring must be fully extended before removing any boom pivot or boom support bolts. This is accomplished by removing the boom elevation cross bar on the housing and elevating the boom all the way. Ensure the boom is restrained so that it does not fall. A falling boom could cause serious injury or death.

EXTENSION

The boom may be manually extended as needed. The boom must be set to the desired length before lifting the load. A boom stop is provided to prevent the inner boom from being inadvertently removed from the outer boom.

CAUTION!

All boom pins must be in place before lifting the load. The boom stop will not support a load. If proper boom pins are not installed the boom may collapse under load causing serious damage and possible injury or death.



-SECTION 3

CRANE SPECIFICATIONS

MODEL 206R CRANES

MOMENT RATING 6500 FT-LBS

LIFTING CAPACITIES AT VARIOUS LOAD RADII

LOAD RADIUS (FT)	CAPACITY (LBS)
3	2000
5	1300
6	1083
7	929
9	722

MAX SINGLE LINE LOAD 1000 LBS
 MAX DOUBLE LINE LOAD 2000 LBS

HOIST FOR THE M (P/N 22289)

LOAD (LBS)	LINE SPEED (FT/MIN)	AMP DRAW
0	26	25
500	22	70
1000	18	115

MAX SINGLE LINE LOAD 2000 LBS

HOIST FOR THE WM (P/N 22803)

LOAD (LBS)	LINE SPEED (FT/MIN)	AMP DRAW
0	17	25
400	16	45
1200	14	85



F1235-D
12/16/09

HOUSTON, TEXAS
 FAX: (800) 824-5559 (USA & Canada)
 FAX: (713) 688-6324
 PHONE: (713) 688-5533
www.liftmoore.com

PERIODIC MAINTENANCE SCHEDULE MODEL 206 CRANES		
BOLTS		
MOUNTING BOLTS	1/2-13 GRADE 8 TORQUE 110FT-LBS DRY	EVERY 4 MONTHS
LUBRICATION		
GREASE FITTINGS	SEE DRAWING 50470	EVERY OTHER WEEK
HYDRAULIC FLUID	STANDARD Chevron AW Hydraulic Oil 46 or equivalent SAE 15 weight oil COLD WEATHER AW 32 or equivalent SAE 10 weight oil	CHECK DAILY, FILL AS NEEDED
BEARING (ZERK AND TEETH)	Oil Center Research PM 600 Military grease or equivalent Benton Based Grease NLGI Grade 2	EVERY 6 HOURS OF OPERATION

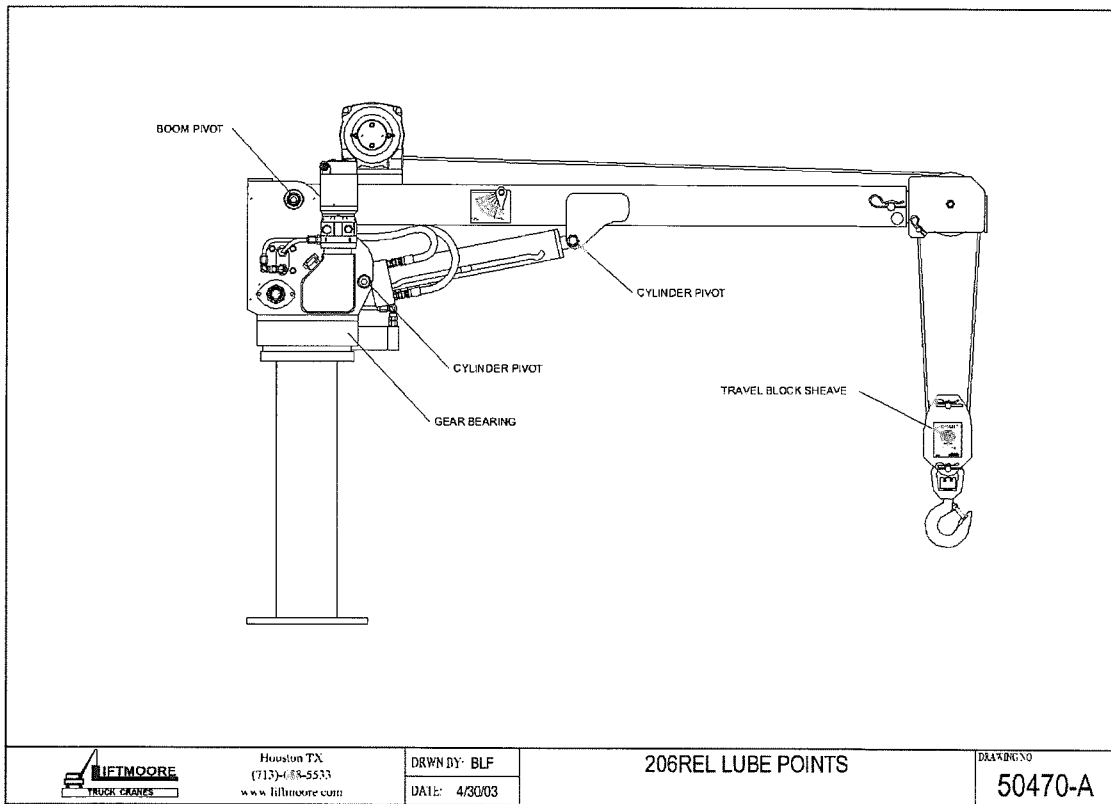

Houston TX
(713)-688-5533
www.liftmoore.com

DRWN BY: BLF
DATE: 4/30/03

206REL LUBE POINTS

DRAWING NO

50470-A



F1235-D
12/16/09

HOUSTON, TEXAS
FAX: (800) 824-5559 (USA & Canada)
FAX: (713) 688-6324
PHONE: (713) 688-5533
www.liftmoore.com

**LIST FOR BOX, CRANE PARTS 206
R/WR/RS**

Items with * have detailed DWG's.

P/N 22789 - BOX, CRANE PARTS 206RS

- 1) P/N 22302 - MANUAL, CRANE 206R/RS/WR..... 1pc
- 2) P/N 33021 - WIRE, BATTERY #1 X 25' W/MECON..... 1pc
- 3) P/N 26084 - WIRE, GROUND 1/0 X 3' LONG..... 1pc
- 4) P/N 30760 - PIN, HITCH 0.75 X 4.50 W/H-PIN..... 2pcs
- 5) P/N 30815 - SCREW, HHC 0.50-13 X 2.50 GR8..... 4pcs
- 6) P/N 30474 - WASHER, LOCK 0.50 GR5 PLATED..... 4pcs
- 7) P/N 31957 - NUT, HEX 0.50-13 GR8 PLATED..... 4pcs
- 8) *P/N 22599 - BLOCK, TRAV ASSY 2.0K LBS/4.0D. 1pc
- 9) P/N 16878 - BREAKER, CIRCUIT 150 AMP..... 1pc
- 10) P/N 16915 - TERMINAL, LUG #1 GA 0.25 DIA..... 2pcs
- 11) P/N 30766 - SWITCH, DISCONNECT..... 1pc
- 12) P/N 17010 - BRACKET, SWITCH MNT. ELE. CRN..... 1pc
- 13) P/N 17063 - TERMINAL, LUG #1 GA 0.37 DIA..... 2pcs
- 14) P/N 30864 - SCREW, HHC 0.62-11 X 1.50 GR8 4pcs
- 15) P/N 31461 - WASHER, LOCK 0.62 GR5 PLATED..... 4pcs
- 16) P/N 22571 - INSTALLATION INTS. 206..... 1pc
- 17) P/N 22373 - DECAL, LOAD CAPACITY 206 1pc

P/N 22031 - BOX, CRANE PARTS 206R

- 1) P/N 22302 - MANUAL, CRANE 206R/RS/WR..... 1pc
- 2) P/N 33021 - WIRE, BATTERY #1 X 25' W/MECON..... 1pc
- 3) P/N 26084 - WIRE, GROUND 1/0 X 3' LONG..... 1pc
- 4) P/N 30760 - PIN, HITCH 0.75 X 4.50 W/H-PIN..... 2pcs
- 5) P/N 30815 - SCREW, HHC 0.50-13 X 2.50 GR8..... 4pcs
- 6) P/N 30474 - WASHER, LOCK 0.50 GR5 PLATED..... 4pcs
- 7) P/N 31957 - NUT, HEX 0.50-13 GR8 PLATED..... 4pcs
- 8) *P/N 22599 - BLOCK, TRAV ASSY 2.0K LBS/4.0D. 1pc
- 9) P/N 16878 - BREAKER, CIRCUIT 150 AMP..... 1pc
- 10) P/N 16915 - TERMINAL, LUG #1 GA 0.25 DIA..... 2pcs
- 11) P/N 30766 - SWITCH, DISCONNECT..... 1pc
- 12) P/N 17010 - BRACKET, SWITCH MNT. ELE. CRN..... 1pc
- 13) P/N 17063 - TERMINAL, LUG #1 GA 0.37 DIA..... 2pcs
- 14) P/N 17181 - SCREW, HHC 0.62-11 X 2.75 GR8..... 4pcs
- 15) P/N 34038 - NUT, HEX 0.62-11 GR8 PLATED 4pcs
- 16) P/N 31461 - WASHER, LOCK 0.62 GR5 PLATED..... 4pcs
- 17) P/N 31054 - WASHER, FLAT 0.62 SAE GR8..... 4pcs
- 18) P/N 22571 - INSTALLATION INTS. 206..... 1pc
- 19) P/N 22373 - DECAL, LOAD CAPACITY 206 1pc



**LIST FOR BOX, CRANE PARTS 206
R/WR/RS**

Items with * have detailed DWG's.

P/N 23395 - BOX, CRANE PARTS 206WR

- 1) P/N 22302 - MANUAL, CRANE 206R/RS/WR.....1pc
- 2) P/N 33021 - WIRE, BATTERY #1 X 25' W/MECON.....1pc
- 3) P/N 26084 - WIRE, GROUND 1/0 X 3' LONG.....1pc
- 4) P/N 30760 - PIN, HITCH 0.75 X 4.50 W/H-PIN.....2pcs
- 5) P/N 30815 - SCREW, HHC 0.50-13 X 2.50 GR8.....4pcs
- 6) P/N 30474 - WASHER, LOCK 0.50 GR5 PLATED.....4pcs
- 7) P/N 31957 - NUT, HEX 0.50-13 GR8 PLATED.....4pcs
- 8) P/N 16878 - BREAKER, CIRCUIT 150 AMP.....1pc
- 9) P/N 16915 - TERMINAL, LUG #1 GA 0.25 DIA.....2pcs
- 10) P/N 30766 - SWITCH, DISCONNECT.....1pc
- 11) P/N 17010 - BRACKET, SWITCH MNT. ELE. CRN.....1pc
- 12) P/N 17063 - TERMINAL, LUG #1 GA 0.37 DIA.....2pcs
- 13) P/N 17181 - SCREW, HHC 0.62-11 X 2.75 GR8.....4pcs
- 14) P/N 34038 - NUT, HEX 0.62-11 GR8 PLATED4pcs
- 15) P/N 31461 - WASHER, LOCK 0.62 GR5 PLATED.....4pcs
- 16) P/N 31054 - WASHER, FLAT 0.62 SAE GR8.....4pcs
- 17) P/N 22571 - INSTALLATION INTS. 206.....1pc
- 18) P/N 22373 - DECAL, LOAD CAPACITY 2061pc



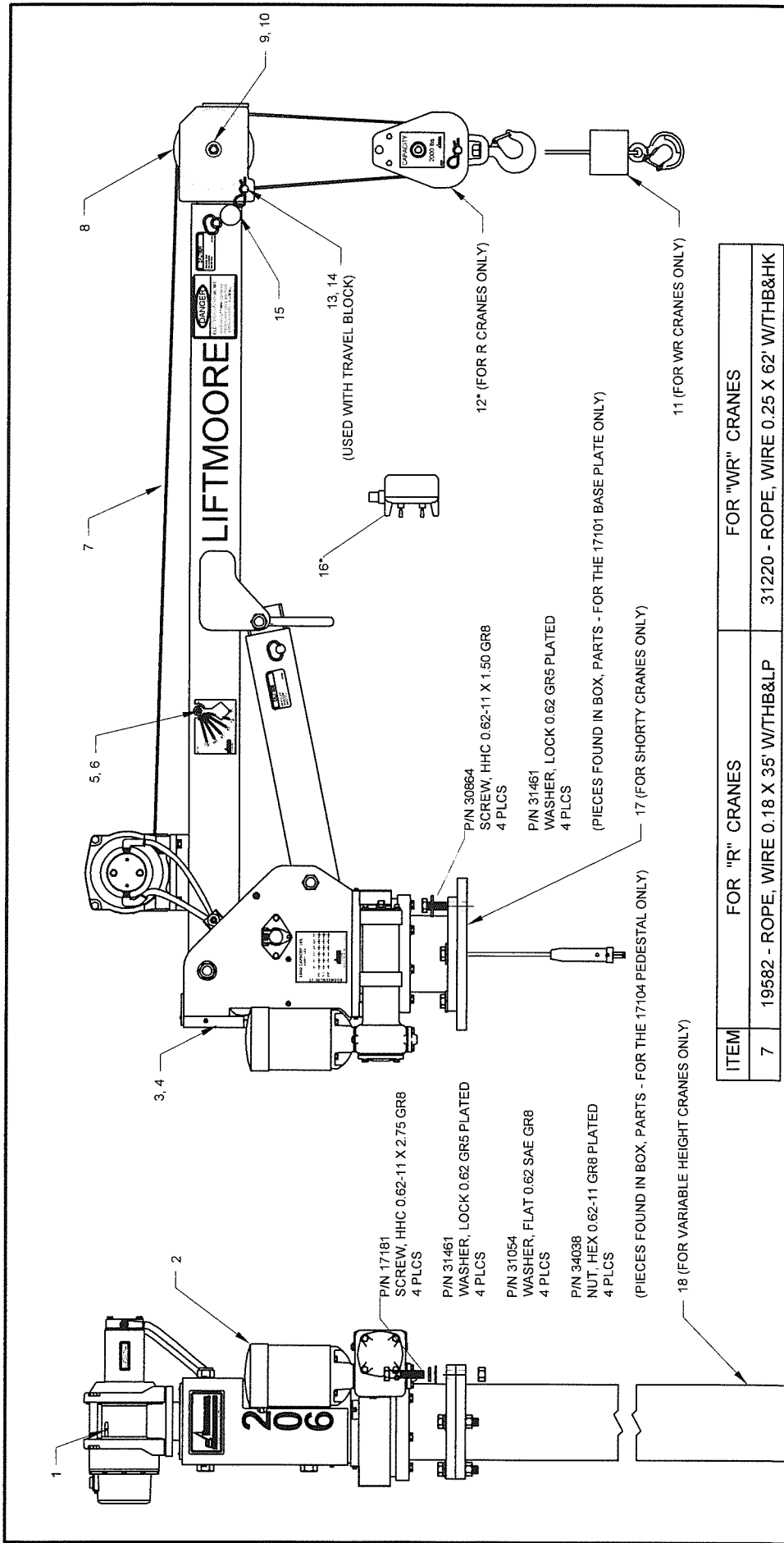

#	PN	DESCRIPTION	QTY	#	PN	DESCRIPTION	QTY	#	PN	DESCRIPTION	QTY
1	70022	WEDGE, WIRE ROPE ANCHOR	1	9	32660	SCREW, HHC 0.50-13 X 2.50 GR8	1	17	17101	PLATE, BASE - FLANGE MNT. MACH	1
2	22790	COVER, PLASTIC WEATHER 206R	1	10	30835	NUT, HEX NYLOC 0.50-13 GRADE 5	1	18	17104	PEDESTAL, L-21RF/22AR VAR. HT.	1
3	21342	COVER, BACK 206R	1	11	30213	PICKLE (WEIGHT)	1	FOR "WR" CRANES			
4	32589	SCREW, HWHSMS 0.25-20 X 0.75	3	12	22599	BLOCK, TRAV ASSY 2.0K LBS/4.0D	1				
5	22394	PENDULUM, LOAD RADIUS DIA. HD	2	13	31603	CLIP, HAIRPIN 0.50 - 0.62	1	FOR BOOM-BODY SEE DWG 50721			
6	31017	SCREW, SHOULDER 0.31-18 X 0.75	2	14	32657	PIN, CLEVIS 0.56 X 2.00 PLATED	1				
7		SEE CHART FOR ROPE WIRE P/N	1	15	31036	STOP, BOOM INNER ASSY STD.	1	NOT SHOWN: 19462 PLATE, SERIAL 206 20674 DECAL KIT 206M			
8	19628	SHEAVE ASSY 5.90PD X 0.25 ROPE	1	16	21014	CONTROL, PENDANT 206R	1				

ITEMS WITH * HAVE DETAIL DRAWINGS

ITEM	FOR "R" CRANES	FOR "WR" CRANES
7	19582 - ROPE, WIRE 0.18 X 35' W/TH&LP	31220 - ROPE, WIRE 0.25 X 62' W/THB&HK

Houston TX
 (713)-688-5533
 www.liftmoore.com

DRWN BY: JC
 DATE: 12/16/09

CRANE ASSEMBLY 206R/WR/RS/WRS

DRAWING NO. **58256-E**

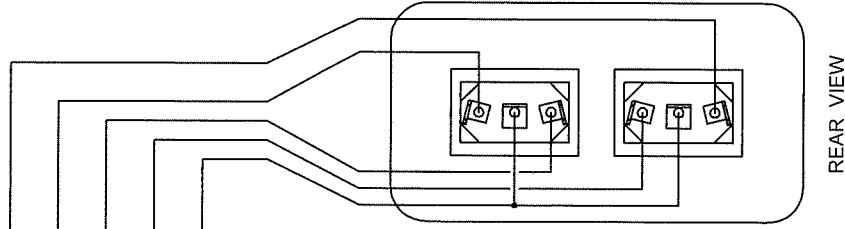

RED
BLACK
BLUE
RED/BLK
WHITE

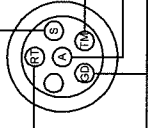

REAR VIEW OF PLUG

Pin Location	Wire Function	Wire Color
S	ROATION CW	RED
TM	HOIST DOWN	BLACK
A	HOIST UP	BLUE
RT	ROATION CCW	RED/BLK
GD	POWER	WHITE

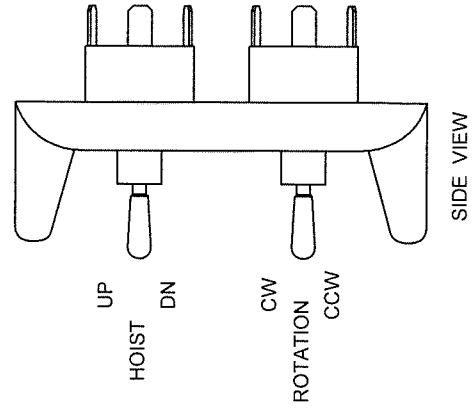

Houston TX
(713)-688-5533
www.iftmoore.com

DRAWN BY: RLC
DATE: 10/10/06

CONTROL, PENDANT 206R

DRAWING NO.
21014-D

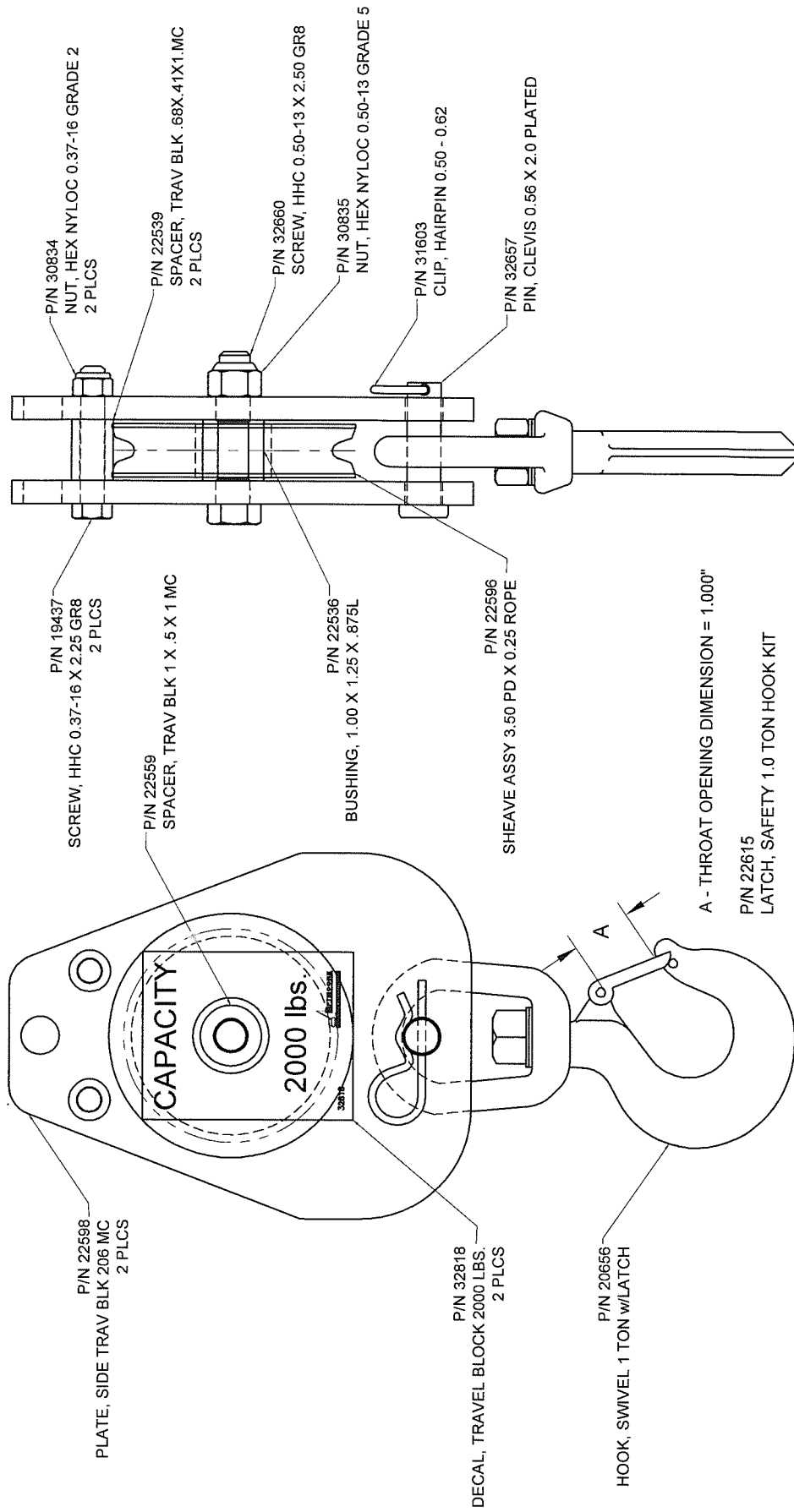

CAUTION:

NEVER USE A HOOK WHOSE THROAT OPENING HAS BEEN INCREASED, OR WHOSE TIP HAS BEEN BENT MORE THAN 10 DEGREES OUT OF PLANE FROM THE HOOK BODY, OR IS IN ANY WAY DISTORTED OR BENT.

Houston TX
 (713)-688-5533
 www.liftmoore.com



BLOCK, TRAV ASSY 2.0K LBS/4.0D
 3.50 PD, 25" & 18" ROPE 2000K

DRAWING NO.

22599-0

DRWN BY: JC
 DATE: 8/23/07

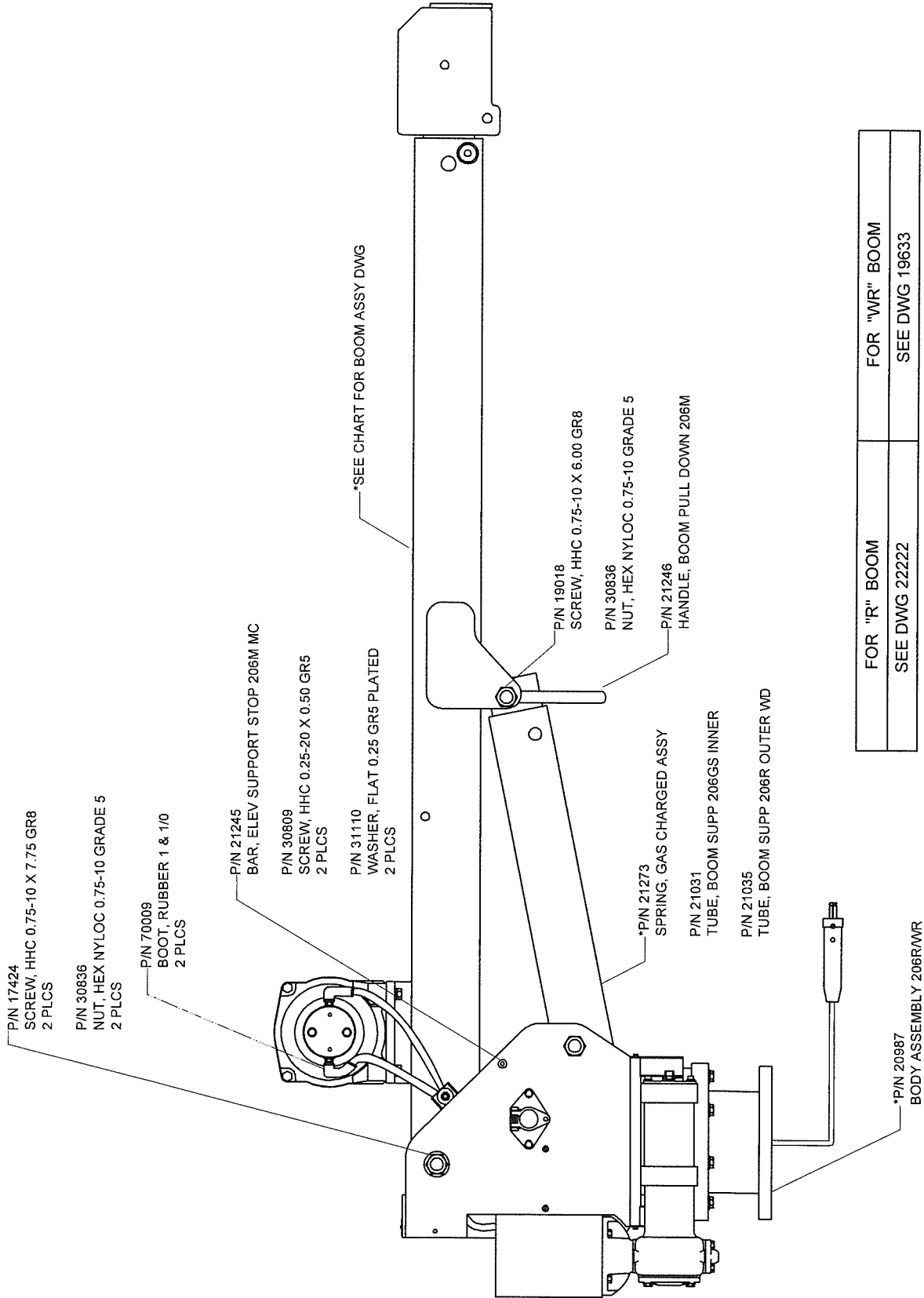

FOR "R" BOOM	FOR "WR" BOOM
SEE DWG 22222	SEE DWG 19633

ITEMS WITH * HAVE DETAIL DRAWINGS

Houston TX
 (713)-688-5533
www.liftmoore.com



BOOM-BODY ASSY 206R
 FOR RWR/RSWRS

DRAWING NO.

50721-A

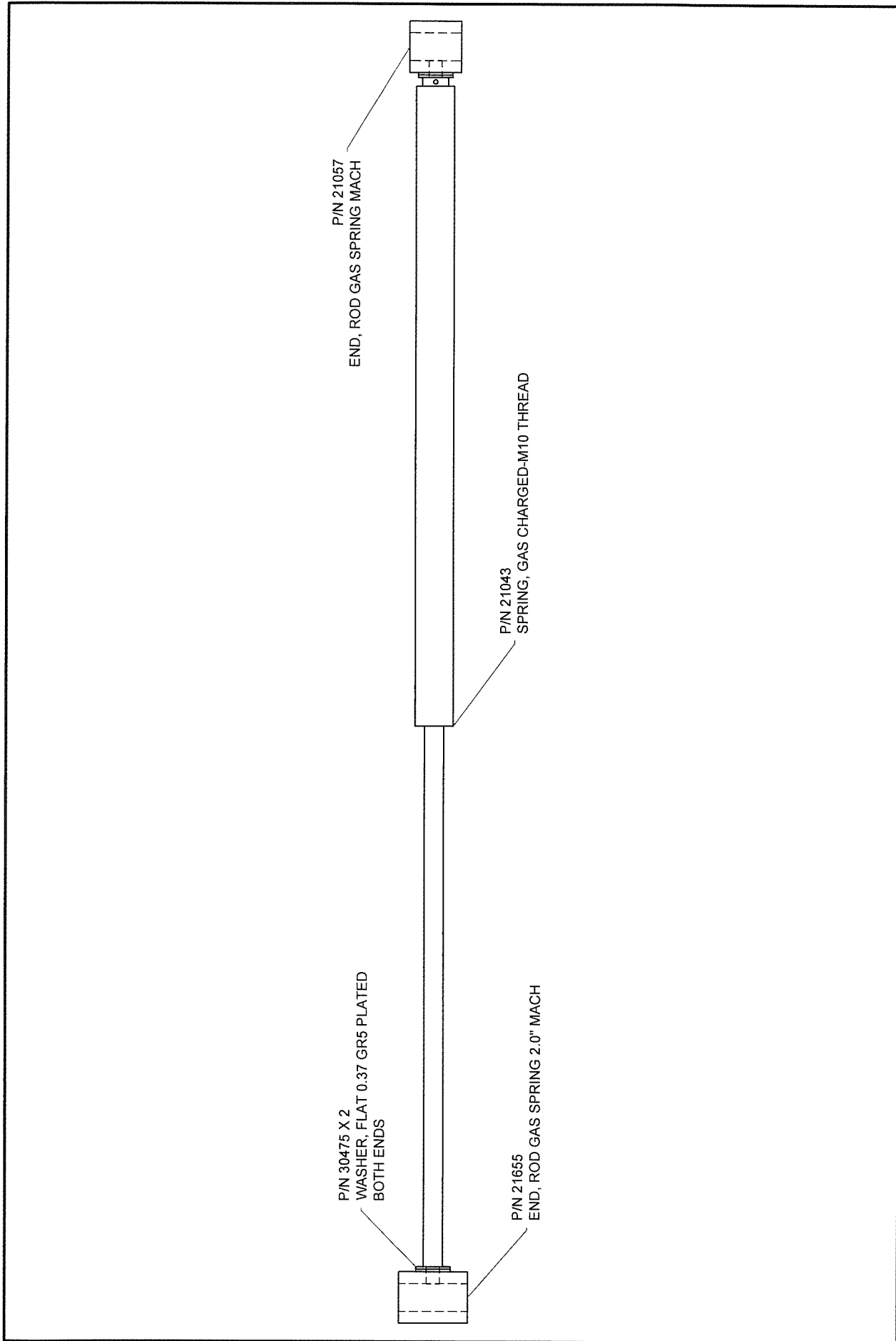

	Houston, TX (713)-688-5533 www.liftmoore.com	DRWN BY: JC DATE: 3/31/08	SPRING, GAS CHARGED ASSY DRAWING NO. 21273-A
---	---	------------------------------	---

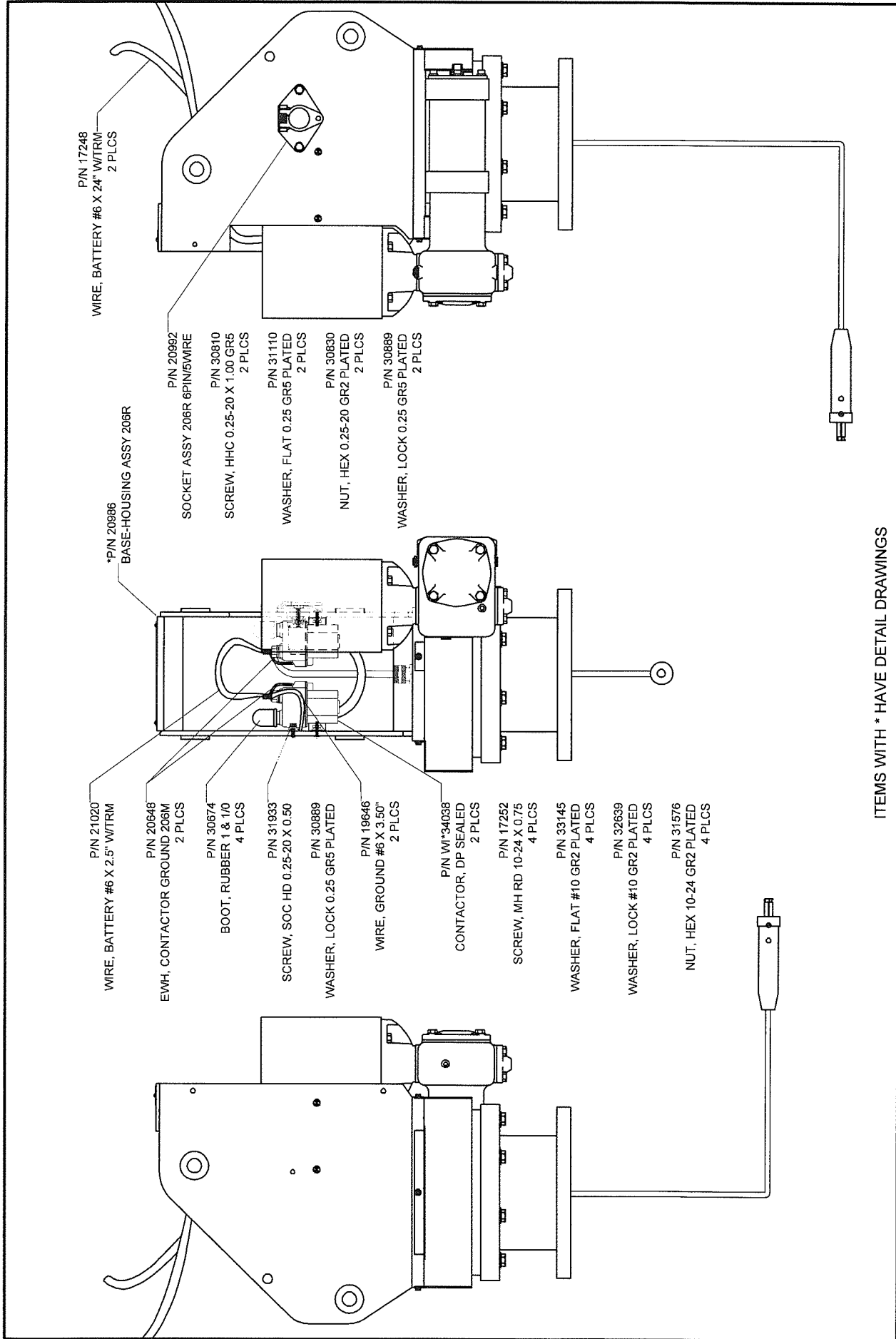

P/N 17248
WIRE, BATTERY #6 X 24" W/TRM
2 PLCS

*P/N 20986
BASE-HOUSING ASSY 206R

P/N 20992
SOCKET ASSY 206R 6P/IN5WIRE

P/N 30810
SCREW, HHC 0.25-20 X 1.00 GR5
2 PLCS

P/N 31110
WASHER, FLAT 0.25 GR5 PLATED
2 PLCS

P/N 30830
NUT, HEX 0.25-20 GR2 PLATED
2 PLCS

P/N 30889
WASHER, LOCK 0.25 GR5 PLATED
2 PLCS

P/N 21020
WIRE, BATTERY #6 X 2.5" W/TRM

P/N 20646
EMH, CONTACTOR GROUND 206M
2 PLCS

P/N 30674
BOOT, RUBBER 1 & 1/0
4 PLCS

P/N 31933
SCREW, SOC HD 0.25-20 X 0.50

P/N 30889
WASHER, LOCK 0.25 GR5 PLATED

P/N 19646
WIRE, GROUND #6 X 3.50"
2 PLCS

P/N W1*34038
CONTACTOR, DP SEALED
2 PLCS

P/N 17252
SCREW, MH RD 10-24 X 0.75
4 PLCS

P/N 33145
WASHER, FLAT #10 GR2 PLATED
4 PLCS

P/N 32638
WASHER, LOCK #10 GR2 PLATED
4 PLCS

P/N 31576
NUT, HEX 10-24 GR2 PLATED
4 PLCS

ITEMS WITH * HAVE DETAIL DRAWINGS

Houston TX
(713)-688-5533
www.liftmoore.com

DRWN BY: JC
DATE: 12/31/08

BODY ASSEMBLY 206R/MR
SHORTY & VARIABLE HEIGHT

DRAWING NO.

20987-B



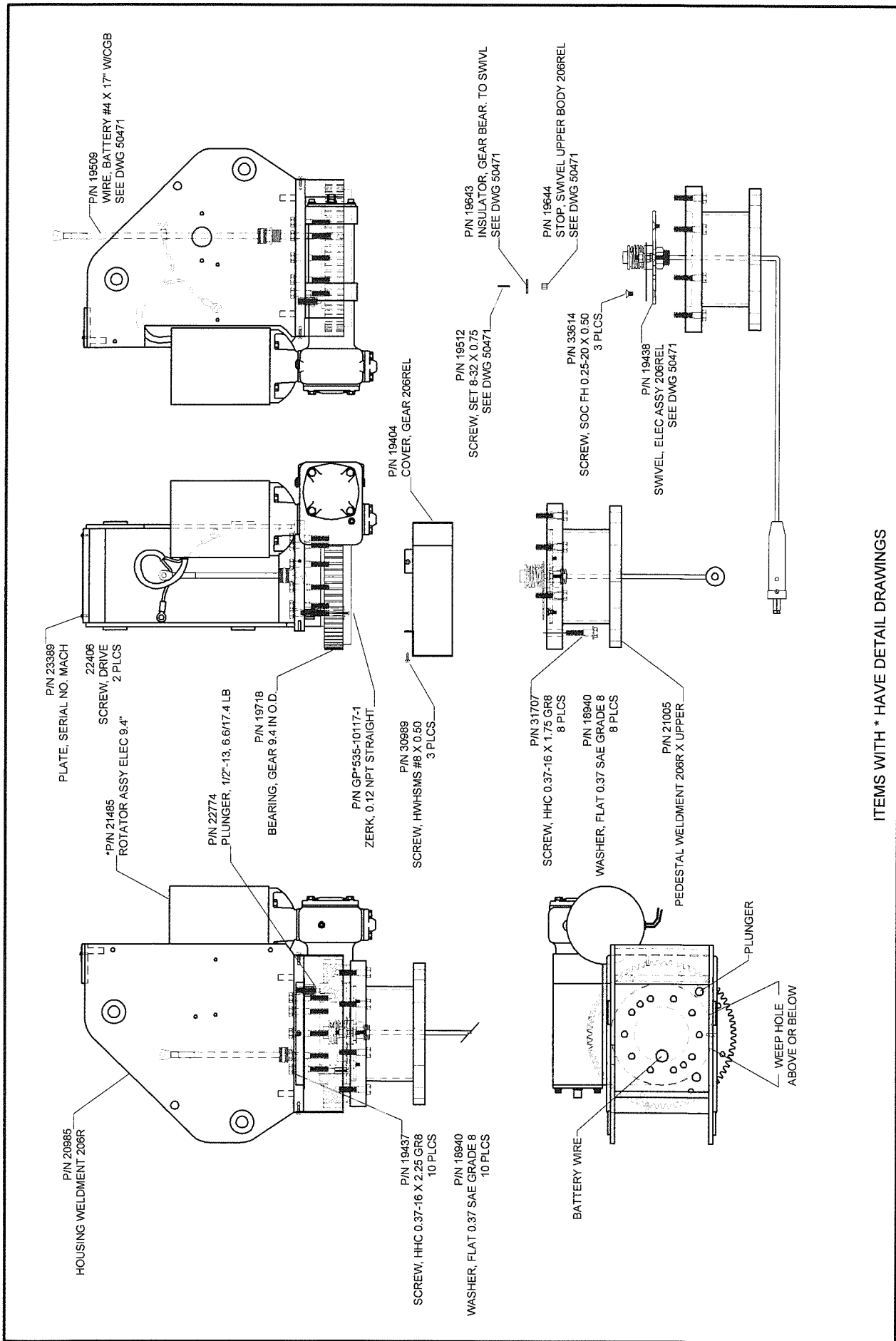

ITEMS WITH * HAVE DETAIL DRAWINGS

Houston TX
 (713)-688-5533
 www.liftmoore.com



DRAWN BY: JC
 DATE: 12/14/09

BASE-HOUSING ASSY 206R/MR
 SHORTY & VARIABLE HEIGHT

DRAWING NO.
20986-E

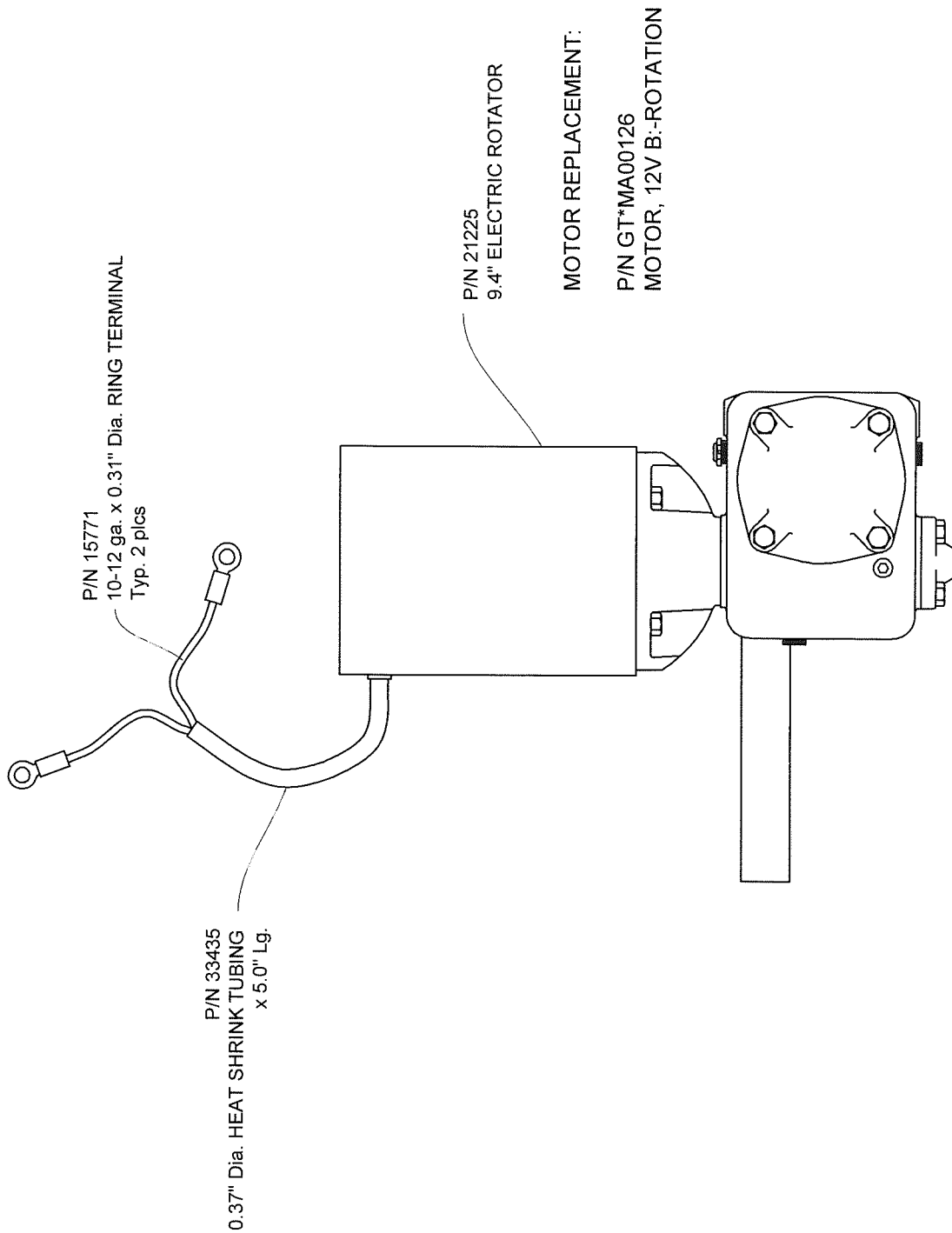

DRAWING NO.
21485-B

ROTATOR ASSY ELEC 9.4"

DRWN BY: JC
DATE: 4/16/08

Houston TX
(713)-688-5533
www.liftmoore.com





BY: JC
DATE: 4/24/08

ELECTRICAL SWIVEL ASSY 206

DOCUMENT NO.

50471-E

DRAWING SHOWS PARTS
BREAK DOWN OF ELECTRIC
SWIVEL ASSEMBLY P/N 19438 &
MOUNTING HARDWARE.

PART NUMBERS MARKED WITH
" * " ARE NOT PART OF THE
ASSEMBLY. IF ORDERING
ENTIRE SWIVEL ASSEMBLY
THESE PARTS MUST BE
ORDERED SEPERATELY.

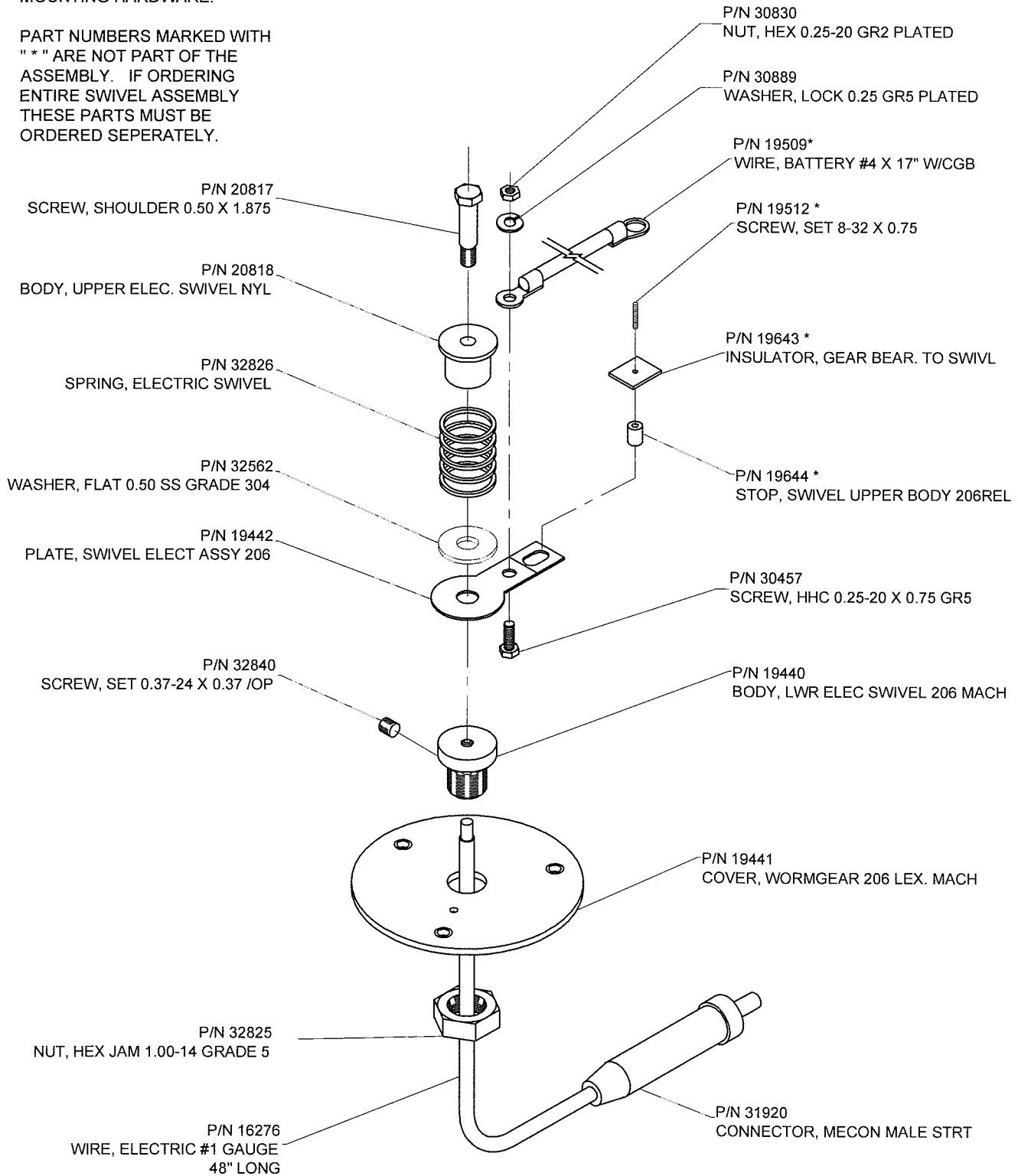

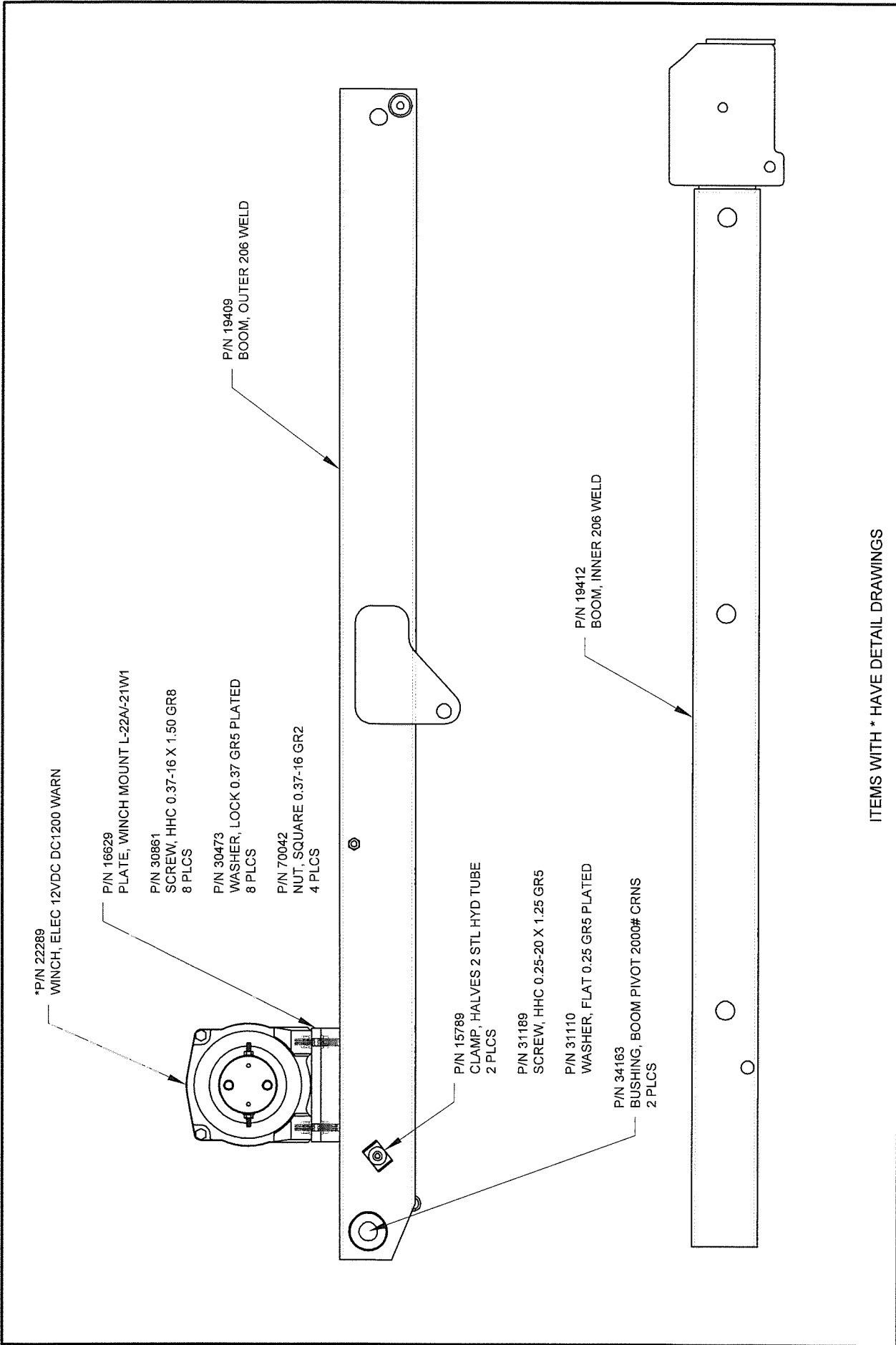

*P/N 22289
WINCH, ELEC 12VDC DC1200 WARN

P/N 16629
PLATE, WINCH MOUNT L-22A-21W1

P/N 30861
SCREW, HHC 0.37-16 X 1.50 GR8
8 PLCS

P/N 30473
WASHER, LOCK 0.37 GR5 PLATED
8 PLCS

P/N 70042
NUT, SQUARE 0.37-16 GR2
4 PLCS

P/N 19409
BOOM, OUTER 206 WELD

P/N 15789
CLAMP, HALVES 2 STL HYD TUBE
2 PLCS

P/N 31189
SCREW, HHC 0.25-20 X 1.25 GR5

P/N 31110
WASHER, FLAT 0.25 GR5 PLATED

P/N 34163
BUSHING, BOOM PIVOT 2000# CRNS
2 PLCS

P/N 19412
BOOM, INNER 206 WELD

ITEMS WITH * HAVE DETAIL DRAWINGS

	Houston TX (713)-688-5533 www.liftmoore.com	DRWN BY: JC DATE: 3/14/08	DRAWING NO. 22222-A
	BOOM ASSEMBLY 206 WITH NEW WINCH P/N 22289		

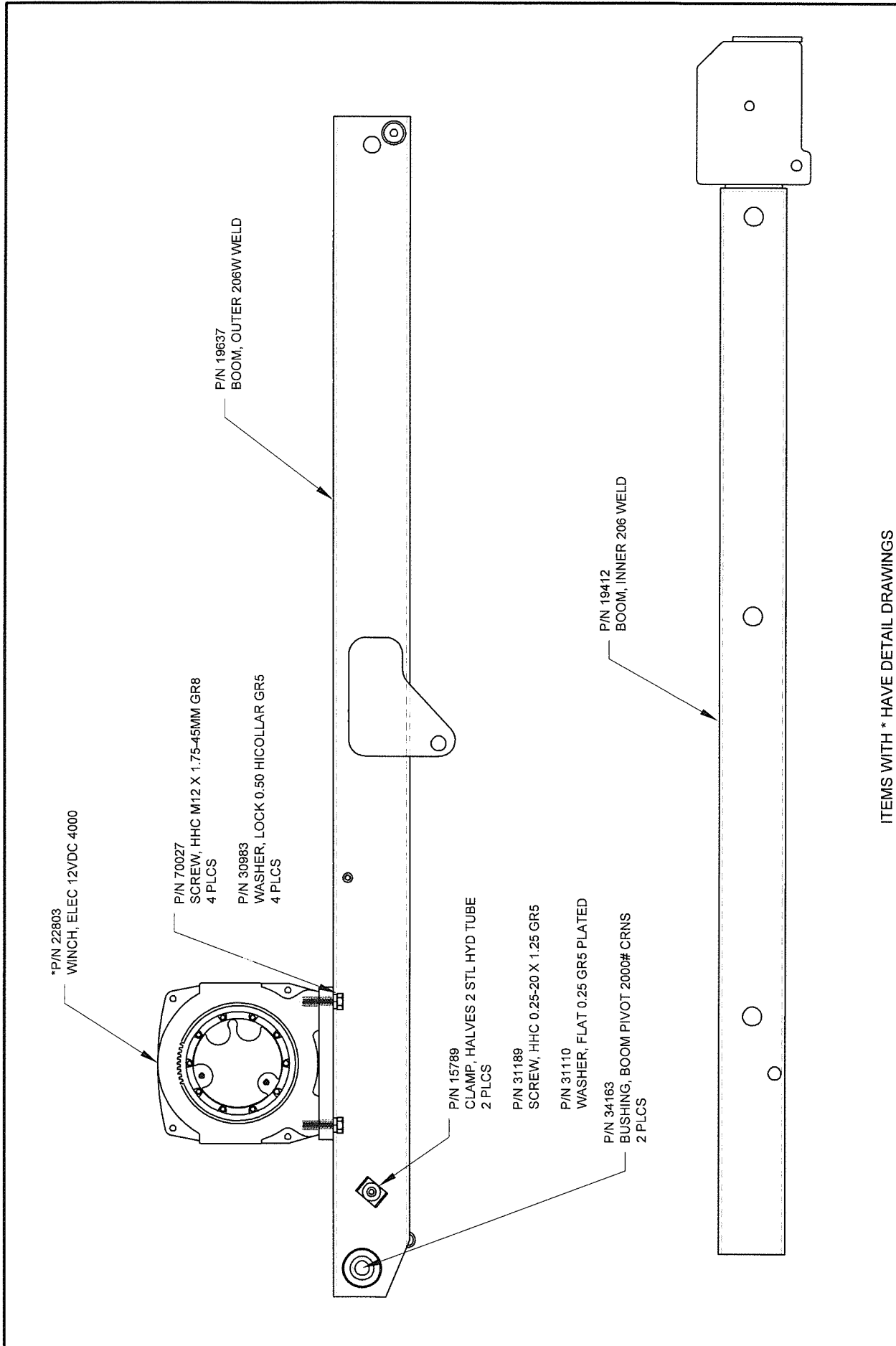

ITEMS WITH * HAVE DETAIL DRAWINGS

	Houston TX (713)-688-5533 www.liftmoore.com	DRWN BY: JC DATE: 12/15/09	BOOM ASSEMBLY 206W W/ WINCH P/N 22803	DRAWING NO. 19633-B
---	---	-------------------------------	--	-------------------------------

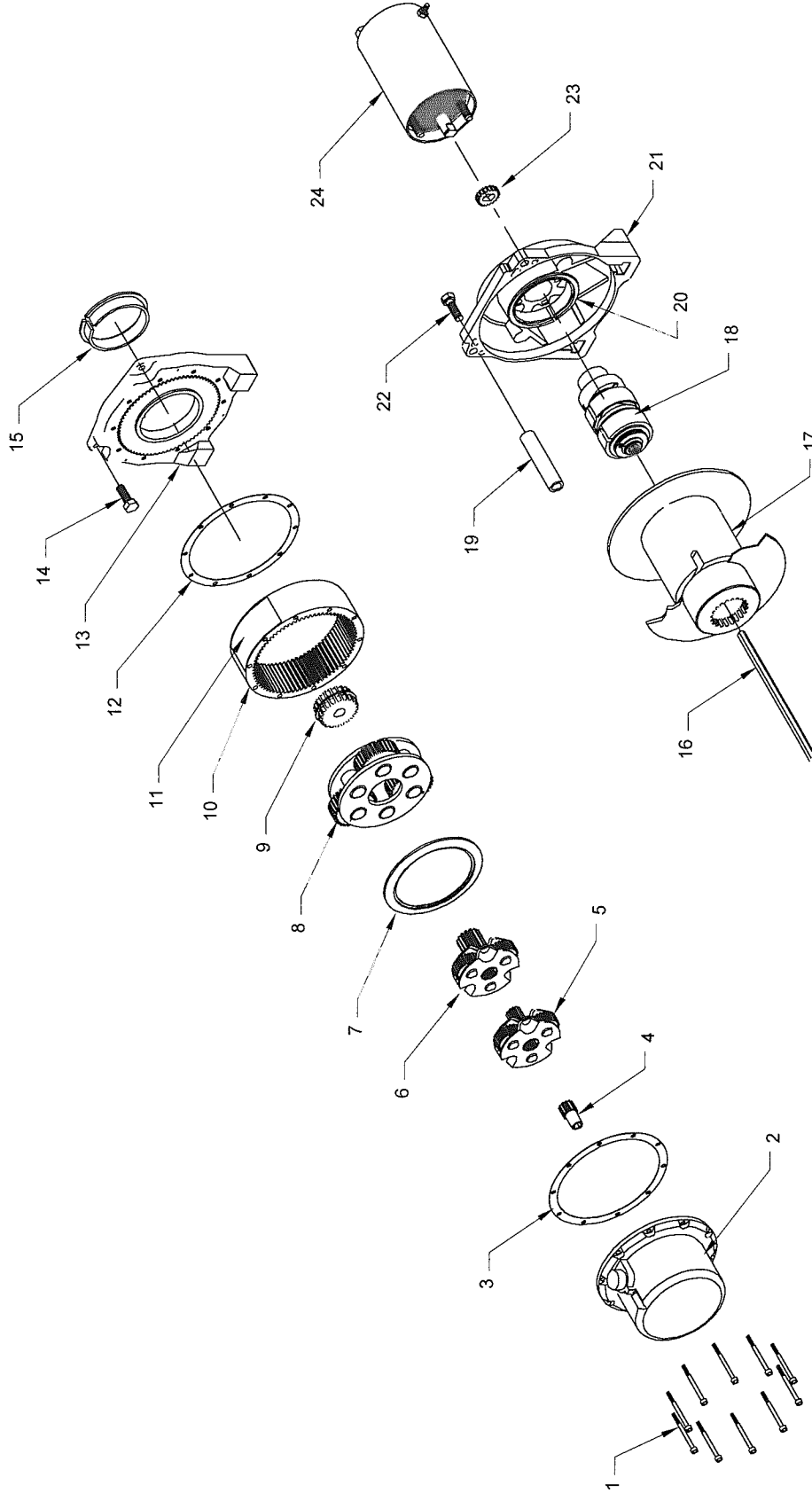

ITEMS WITH * HAVE DETAIL DRAWINGS

#	PN	DESCRIPTION	QTY	#	PN	DESCRIPTION	QTY	#	PN	DESCRIPTION	QTY
1	WI*13850	SCREW, SOCKET HEAD	10	9	WI*13824	DRIVE SPLINE	1	17	WI*39821	DRUM ASSEMBLY DC1200	1
2	WI*60045	CLUTCH HOUSING	1	10	WI*25308	GEAR, RING BLACK 75t	1	18	WI*13799	BRAKE ASSEMBLY H2000 WINCH	1
3	WI*13848	GASKET	1	11	WI*61736	SCREW, SOCKET HEAD	1	19	WI*34478	SPACER	2
4	WI*13874	GEAR, SUN 1ST STAGE	1	12	WI*13848	GASKET	1	20	WI*13831	BUSHING, DRUM	1
5	WI*28430	CARRIER ASSY, 1ST STAGE	1	13	WI*25747	SUPPORT, DRUM/GEARTRAIN DC1200	1	21	WI*73902	ADAPTER, WINCH MOTOR MOUNT	1
6	WI*28431	CARRIER ASSY, 2ND STAGE	1	14	WI*37028	BOLT, SELF TAPPING .77	2	22	WI*37028	BOLT, SELF TAPPING .77	1
7	WI*13826	BUSHING, CARRIER	2	15	WI*13831	BUSHING, DRUM	1	23	WI*32240	GEAR, INPUT (WIDE)	1
8	WI*28432	CARRIER ASSY, 3RD STAGE	1	16	WI*39598	SHAFT	1	24	WI*74853	MOTOR, 12V WINCH WARN DC1200	1

Houston, TX
(713)-688-5533
www.liftmoore.com

WINCH, ELEC 12VDC DC1200 WARN

REPLACE 19378; SEE NOTE

DRAWING NO. **22289-A**

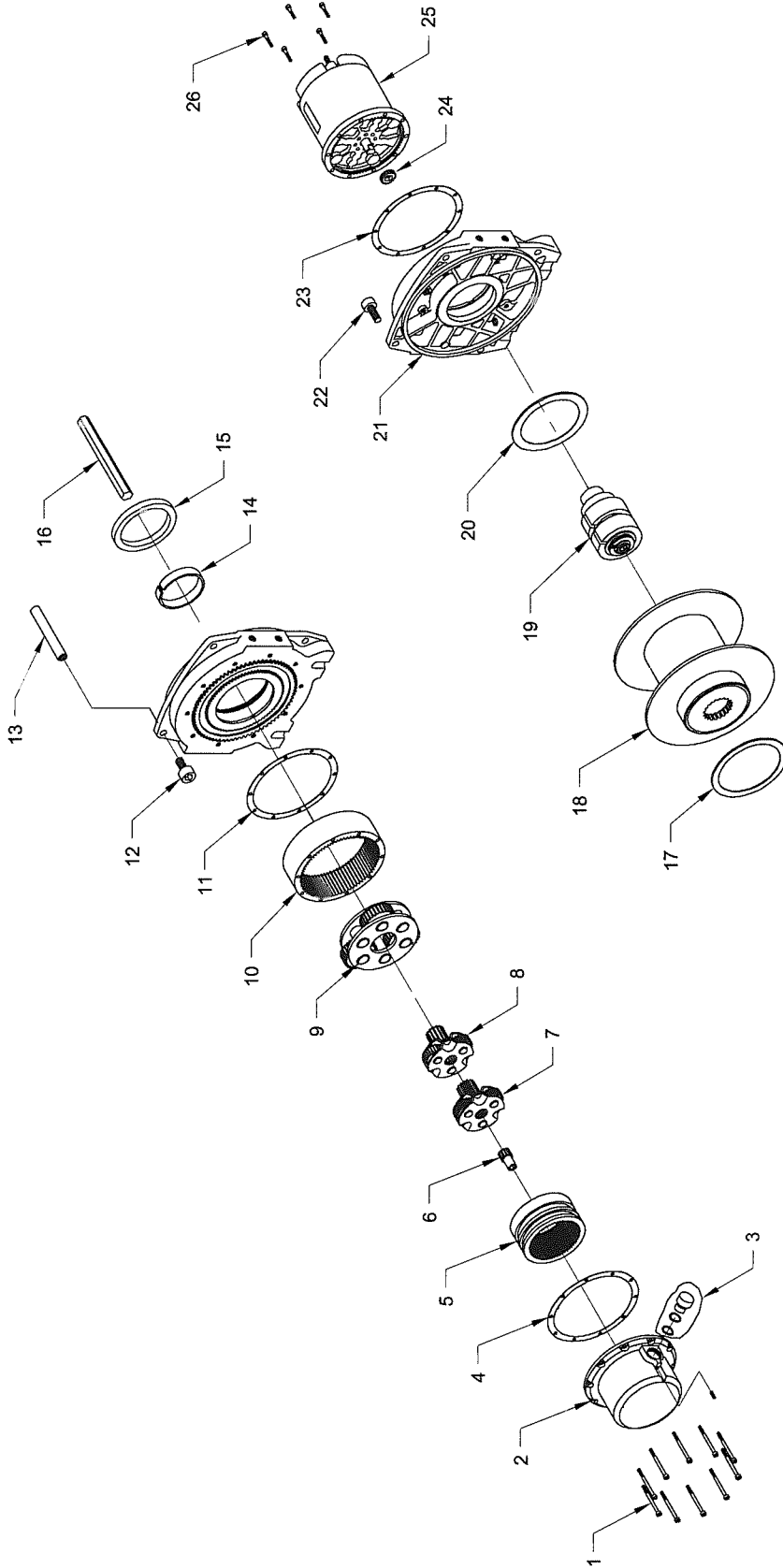

ITEMS WITH * HAVE DETAIL DRAWINGS

#	PN	DESCRIPTION	QTY	#	PN	DESCRIPTION	QTY	#	PN	DESCRIPTION	QTY
1	WI*13850	SCREW, SOCKET HEAD	10	10	WI*25308	GEAR, RING BLACK 75t	1	19	WI*63550	BRAKE ASSY DC1600	1
2	WI*25307	HOUSING, GEAR	1	11	WI*13848	GASKET	1	20	WI*30277	WASHER, THRUST	1
3	WI*21213	CLUTCH BLOCKOUT	1	12	WI*61736	SCREW, SOCKET HEAD	3	21	WI*60043	SUPPORT, DRUM 4" BORE DC1600	1
4	WI*13848	GASKET	1	13	WI*32189	ROD, TIE/TAPPED	3	22	WI*61736	SCREW, SOCKET HEAD	3
5	WI*28353	GEAR, RING	1	14	WI*30274	BUSHING, DRUM NYLON	1	23	WI*13848	GASKET	1
6	WI*13874	GEAR, SUN 1ST STAGE	1	15	WI*30275	SEAL, OIL RADIAL	1	24	WI*32240	GEAR, INPUT (WIDE)	1
7	WI*28430	CARRIER ASSY, 1ST STAGE	1	16	WI*61843	SHAFT	1	25	WI*14114	MOTOR, 12V WINCH WARN DC1600	1
8	WI*28433	CARRIER ASSY, 2ND STAGE	1	17	WI*30277	WASHER, THRUST	1	26	WI*5553	SCREW, SOC HD 10-24 X 0.75	5
9	WI*28115	CARRIER ASSY, 3RD STAGE	1	18	WI*31619	DRUM ASSEMBLY	1				



Houston TX
(713)-688-5533
www.iftmoore.com

DRWN BY: JC
DATE: 12/16/08

WINCH, ELEC 12VDC 4000
WARN DC-2000 LF: 4.25" DRUM

DRAWING NO.
22803-A

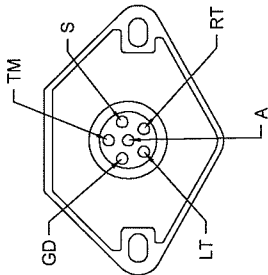
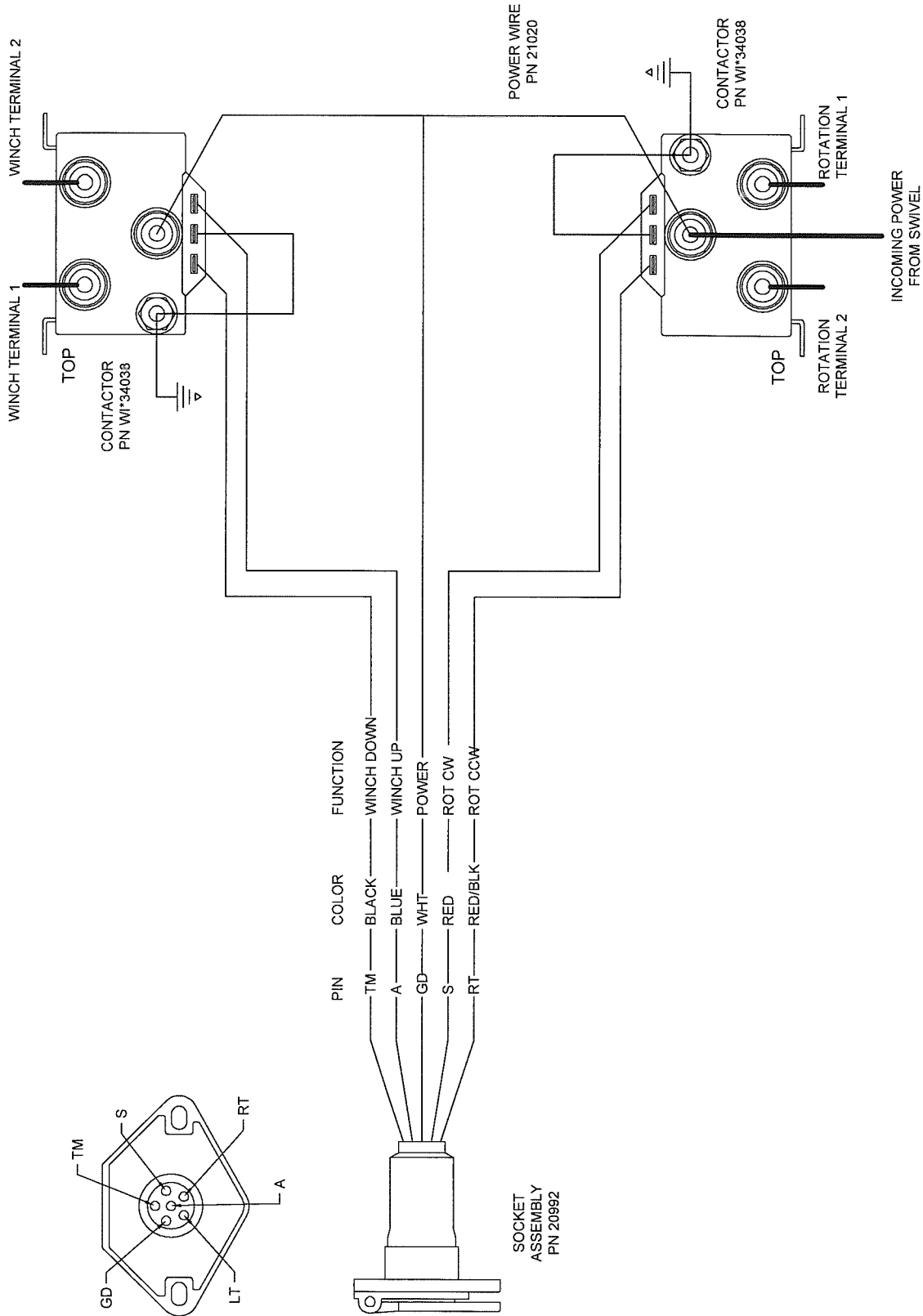

PIN	COLOR	FUNCTION
TM	BLACK	WINCH DOWN
A	BLUE	WINCH UP
GD	WHT	POWER
S	RED	ROT CW
RT	RED/BLK	ROT CCW

SOCKET ASSEMBLY PN 20992

DRAWING NO. 50539-B

SCHEM, ELEC WIRING 206R

DRWN BY: JC
DATE: 4/17/08

Houston TX
(713)-688-5533
www.liftmoore.com



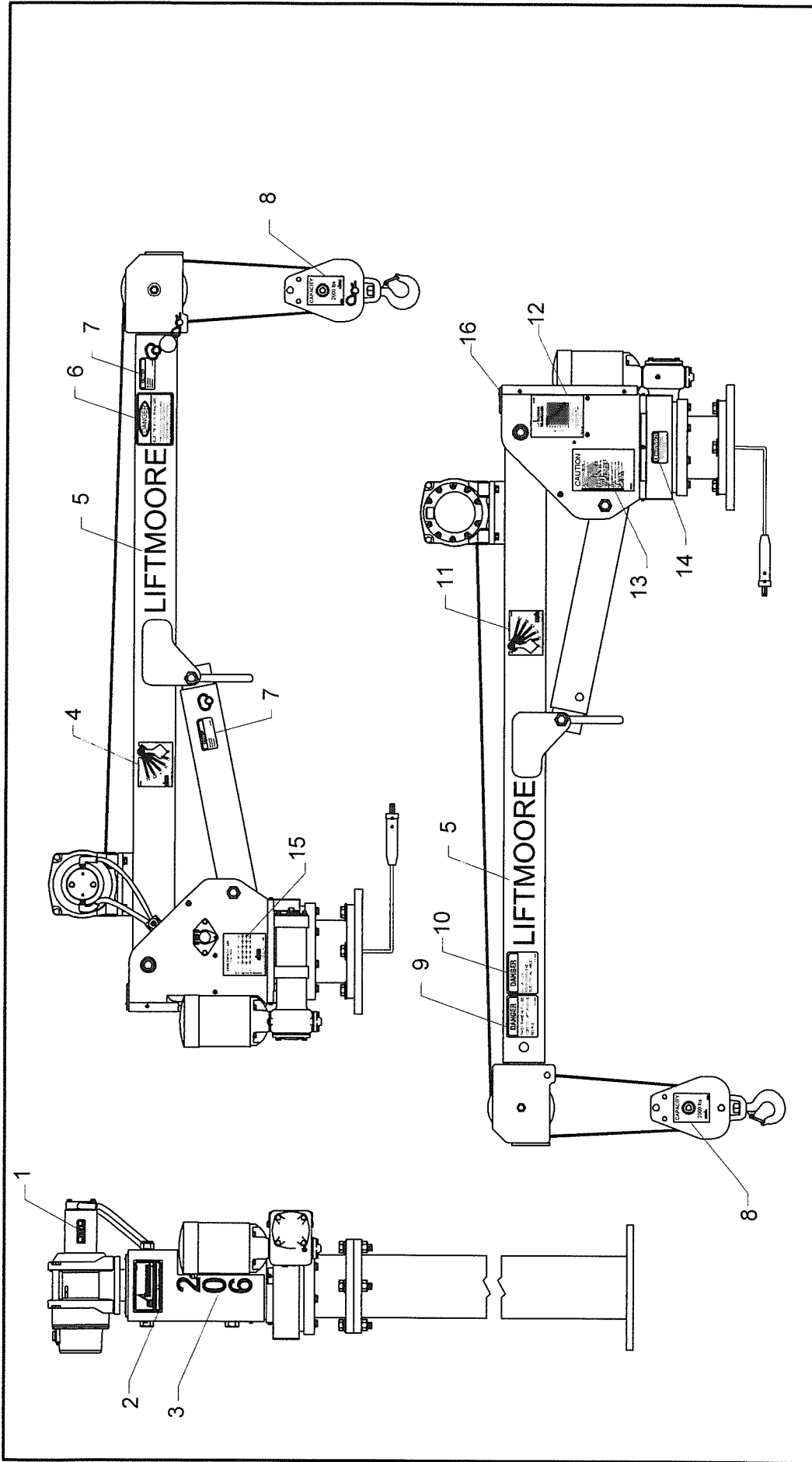

#	PN	DESCRIPTION	QTY	#	PN	DESCRIPTION	QTY	#	PN	DESCRIPTION
1	32608	DECAL, MOTOR MAGNETS DAMAGE	1	7	15612	DECAL, CAUTION PIN MUST BE IN	2	13	16102	DECAL, CAUTION READ MANUAL
2	15582	DECAL, LOGO SMALL	1	8	32818	DECAL, TRAVEL BLOCK 2000 LBS.	2	14	15577	DECAL, ATTENTION BATTERY
3	19464	DECAL, 206	1	9	32085	DECAL, LIFTING PERSONNEL	1	15	22373	DECAL, LOAD CAPACITY 206
4	22376	DECAL, ANGLE PENDULUM RIGHT	1	10	15579	DECAL, DANGER CABLES	1	16	23389	PLATE, SERIAL NO. MACH
5	34041	DECAL, LIFTMOORE - 2.00"	2	11	22375	DECAL, ANGLE PENDULUM LEFT	1			
6	15618	DECAL, DANGER ELECTRIC INJURY	1	12	19462	PLATE, SERIAL 206	1			

Houston TX
(713)-688-5533
www.liftmoore.com

DRWN BY: JC
DATE: 11/18/09

DECAL DIAGRAM FOR THE
206R/RS

DRAWING NO.
58283-C

THIS PAGE INTENTIONALLY LEFT BLANK



HOUSTON, TEXAS
FAX: (800) 824-5559 (USA & Canada)
FAX: (713) 688-6324
PHONE: (713) 688-5533
www.liftmoore.com

LIFTMOORE LIMITED WARRANTY

Parts and Structural

Liftmoore, Inc. warrants each LIFTMOORE crane to be free from defects in materials and workmanship for twelve (12) months from the date of delivery to the original customer. Under the terms of this warranty the crane structural components manufactured by LIFTMOORE, Inc. are warranted for thirty-six (36) months from the date of delivery to the original customer. LIFTMOORE, Inc. will repair or replace, as its sole discretion, any equipment or part that is returned f.o.b. to LIFTMOORE, Inc.'s plant at 7810 Pinemont Drive, Houston, Texas 77040, or to one of its authorized dealers, and is found by LIFTMOORE, Inc. or its authorized dealer to have been defective at the time of original delivery.

The foregoing warranty is the exclusive warranty made by LIFTMOORE, Inc. with respect to its cranes and is in lieu of all other warranties. ANY AND ALL OTHER WARRANTIES, EXPRESS OR IMPLIED, INCLUDING ANY WARRANTY OF MERCHANTABILITY OR FITNESS OF ANY CRANE FOR A PARTICULAR PURPOSE OR OPERATION, ARE HERBY EXPRESSLY DISCLAIMED.

The foregoing warranty applies only to LIFTMOORE cranes under normal use and service and does not apply in the event of damage caused by repair or alteration or damage during shipment, accident, negligence, overloading, or misuse, including operator's failure to follow any of the instructions issued with the crane.

This warranty is limited to the original purchaser and is not assignable. In order to submit a claim, the original purchaser must provide a copy of the original invoice for the crane in question within twelve (12) months following the delivery date and within 30 days from the date of repair.

The warranty applies only when the LIFTMOORE crane is used for commercial purposes and does not cover any purchase for use for personal, family or household purposes.

LIMITATION OF LIABILITY: LIFTMOORE, Inc.'s liability for any losses or damages resulting from any cause whatsoever, including LIFTMOORE, Inc.'s NEGLIGENCE or from a defective crane irrespective of whether such defects are discoverable or latent, shall in no event exceed the purchase price of the crane to which losses or damages are claimed, or at the election of LIFTMOORE, Inc., the repair or replacement of the defective crane.

In no event shall LIFTMOORE, Inc. be liable for any special, incidental, or consequential damages, including commercial losses or costs of any kind sustained by purchaser or any other person or for any damages for which purchaser may be liable to other persons by reason of any defect in any LIFTMOORE crane or any part thereof.

LIFTMOORE, Inc. reserves the right to make changes in design or construction of its cranes at any time without obligating itself to make such changes on cranes previously manufactured.

No agent, employee, or representative of LIFTMOORE, Inc. has authority to amend or modify the foregoing warranty or to bind LIFTMOORE, Inc. by any other warranty, guaranty, or assumption of liability.

In the event any provision of this warranty is for any reason held ineffective, the remaining provisions shall remain in full force and effect.

Some states do not allow limitations on how long an implied warranty lasts or the exclusion or limitation of incidental or consequential damages, so the above limitations and exclusions may not apply to you. This warranty gives you specific legal rights, and you may also have other legal rights that vary from state to state.

